

MC33269, NCV33269

800 mA, Adjustable Output, Low Dropout Voltage Regulator

The MC33269/NCV33269 series are low dropout, medium current, fixed and adjustable, positive voltage regulators specifically designed for use in low input voltage applications. These devices offer the circuit designer an economical solution for precision voltage regulation, while keeping power losses to a minimum.

The regulator consists of a 1.0 V dropout composite PNP-NPN pass transistor, current limiting, and thermal shutdown.

- 3.3 V, 5.0 V, 12 V and Adjustable Versions.
2.85 V version available as MC34268.
- Space Saving DPAK, SOP-8 and SOT-223 Power Packages
- 1.0 V Dropout
- Output Current in Excess of 800 mA
- Thermal Protection
- Short Circuit Protection
- Output Trimmed to 1.0% Tolerance
- Pb-Free Package is Available

DEVICE TYPE/NOMINAL OUTPUT VOLTAGE

MC33269D	Adj	MC33269D-5.0	5.0 V
MC33269DT	Adj	MC33269DT-5.0	5.0 V
NCV33269DTRK*	Adj		
MC33269T	Adj	MC33269T-5.0	5.0 V
MC33269D-3.3	3.3 V	MC33269D-12	12 V
MC33269DT-3.3	3.3 V	MC33269DT-12	12 V
NCV33269DTRK-3.3*	3.3 V	NCV33269DTRK-12*	12 V
MC33269T-3.3	3.3 V	MC33269T-12	12 V
MC33269ST-3.3	3.3 V		

*NCV prefix is for automotive and other applications requiring site and change control.



ON Semiconductor®

<http://onsemi.com>

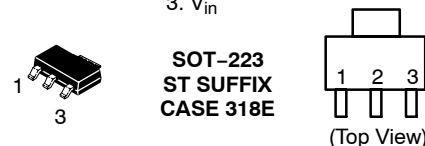
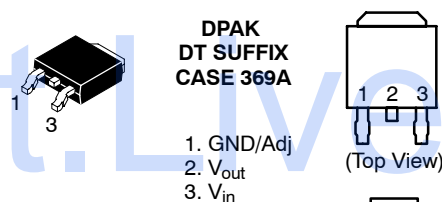
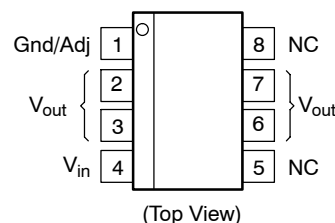

Heatsink surface (shown as terminal 4 in case outline drawing) is connected to Pin 2.

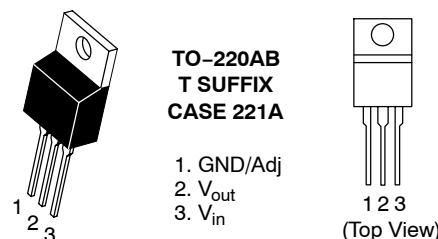

Heatsink surface (shown as terminal 4 in case outline drawing) is connected to Pin 2.

ORDERING INFORMATION

See detailed ordering and shipping information in the package dimensions section on page 233 of this data sheet.

DEVICE MARKING INFORMATION

See general marking information in the device marking section on page 234 of this data sheet.

MC33269, NCV33269

MAXIMUM RATINGS

Rating	Symbol	Value	Unit
Power Supply Input Voltage	V_{in}	20	V
Power Dissipation			
Case 369A (DPAK)			
$T_A = 25^\circ\text{C}$	P_D	Internally Limited	W
Thermal Resistance, Junction-to-Ambient	θ_{JA}	92	$^\circ\text{C/W}$
Thermal Resistance, Junction-to-Case	θ_{JC}	6.0	$^\circ\text{C/W}$
Case 751 (SOP-8)			
$T_A = 25^\circ\text{C}$	P_D	Internally Limited	W
Thermal Resistance, Junction-to-Ambient	θ_{JA}	160	$^\circ\text{C/W}$
Thermal Resistance, Junction-to-Case	θ_{JC}	25	$^\circ\text{C/W}$
Case 221A			
$T_A = 25^\circ\text{C}$	P_D	Internally Limited	W
Thermal Resistance, Junction-to-Ambient	θ_{JA}	65	$^\circ\text{C/W}$
Thermal Resistance, Junction-to-Case	θ_{JC}	5.0	$^\circ\text{C/W}$
Case 318E			
$T_A = 25^\circ\text{C}$	P_D	Internally Limited	W
Thermal Resistance, Junction-to-Ambient	θ_{JA}	156	$^\circ\text{C/W}$
Thermal Resistance, Junction-to-Case	θ_{JC}	15	$^\circ\text{C/W}$
Operating Die Junction Temperature Range	T_J	-40 to +150	$^\circ\text{C}$
Operating Ambient Temperature Range			
		MC3326	
		NCV33269	
	T_A	-40 to +125	$^\circ\text{C}$
		-40 to +125	
Storage Temperature	T_{stg}	-55 to +150	$^\circ\text{C}$
Electrostatic Discharge Sensitivity (ESD)	ESD		V
Human Body Model (HBM)		4000	
Machine Model (MM)		400	

MC33269, NCV33269

ELECTRICAL CHARACTERISTICS ($C_O = 10 \mu\text{F}$, $T_A = 25^\circ\text{C}$, for min/max values $T_A = -40^\circ\text{C}$ to $+125^\circ\text{C}$, unless otherwise noted.)

Characteristic	Symbol	Min	Typ	Max	Unit
Output Voltage ($I_{out} = 10 \text{ mA}$, $T_A = 25^\circ\text{C}$) 3.3 Suffix ($V_{CC} = 5.3 \text{ V}$) 5.0 Suffix ($V_{CC} = 7.0 \text{ V}$) 12 Suffix ($V_{CC} = 14 \text{ V}$)	V_O	3.27 4.95 11.88	3.3 5.0 12	3.33 5.05 12.12	V
Output Voltage (Line, Load and Temperature) (Note 1) ($1.25 \text{ V} \leq V_{in} - V_{out} \leq 15 \text{ V}$, $I_{out} = 500 \text{ mA}$) ($1.35 \text{ V} \leq V_{in} - V_{out} \leq 10 \text{ V}$, $I_{out} = 800 \text{ mA}$) 3.3 Suffix 5.0 Suffix 12 Suffix	V_O	3.23 4.9 11.76	3.3 5.0 12	3.37 5.1 12.24	V
Reference Voltage ($I_{out} = 10 \text{ mA}$, $V_{in} - V_{out} = 2.0 \text{ V}$, $T_A = 25^\circ\text{C}$) for Adjustable Voltage	V_{ref}	1.235	1.25	1.265	V
Reference Voltage (Line, Load and Temperature) (Note 1) ($1.25 \text{ V} \leq V_{in} - V_{out} \leq 15 \text{ V}$, $I_{out} = 500 \text{ mA}$) ($1.35 \text{ V} \leq V_{in} - V_{out} \leq 10 \text{ V}$, $I_{out} = 800 \text{ mA}$) for Adjustable Voltage	V_{ref}	1.225	1.25	1.275	V
Line Regulation ($I_{out} = 10 \text{ mA}$, $V_{in} = [V_{out} + 1.5 \text{ V}]$ to $V_{in} = 20 \text{ V}$, $T_A = 25^\circ\text{C}$)	Reg_{line}	-	-	0.3	%
Load Regulation ($V_{in} = V_{out} + 3.0 \text{ V}$, $I_{out} = 10 \text{ mA}$ to 800 mA , $T_A = 25^\circ\text{C}$)	Reg_{load}	-	-	0.5	%
Dropout Voltage ($I_{out} = 500 \text{ mA}$) ($I_{out} = 800 \text{ mA}$)	$V_{in} - V_{out}$	- -	1.0 1.1	1.25 1.35	V
Ripple Rejection (10 V_{pp} , 120 Hz Sinewave; $I_{out} = 500 \text{ mA}$)	RR	55	-	-	dB
Current Limit ($V_{in} - V_{out} = 10 \text{ V}$)	I_{Limit}	800	-	-	mA
Quiescent Current (Fixed Output) ($1.5 \text{ V} \leq V_{out} \leq 3.3 \text{ V}$) ($5 \text{ V} \leq V_{out} \leq 12 \text{ V}$)	I_Q	- -	5.5 -	8.0 20	mA
Minimum Required Load Current Fixed Output Voltage Adjustable Voltage	I_{Load}	- 8.0	- -	0 -	mA
Adjustment Pin Current	I_{Adj}	-	-	120	μA

1. The MC33269-12, $V_{in} - V_{out}$ is limited to 8.0 V maximum, because of the 20 V maximum rating applied to V_{in} .

MC33269, NCV33269

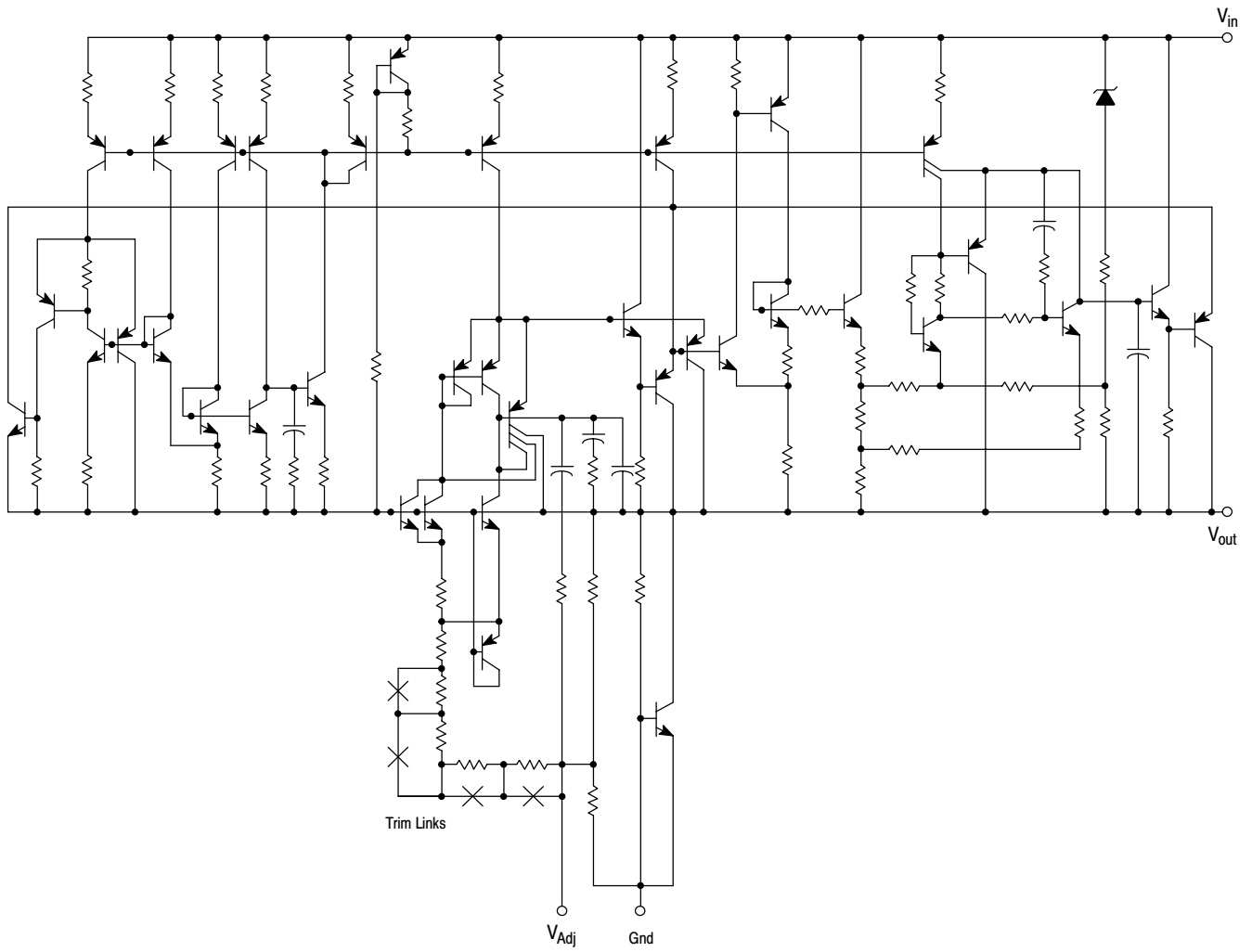

This device contains 38 active transistors.

Figure 1. Internal Schematic

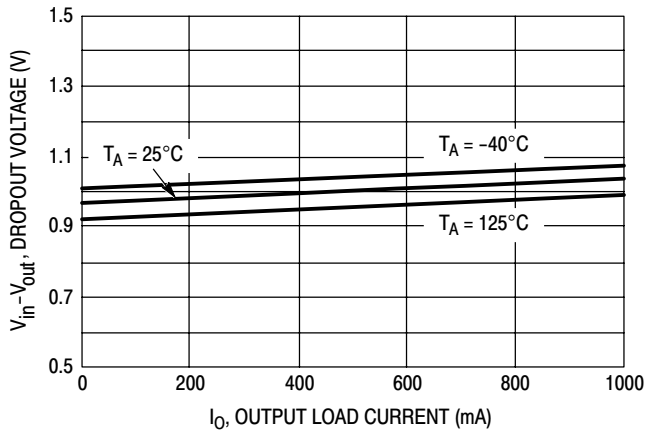

Figure 2. Dropout Voltage versus Output Load Current

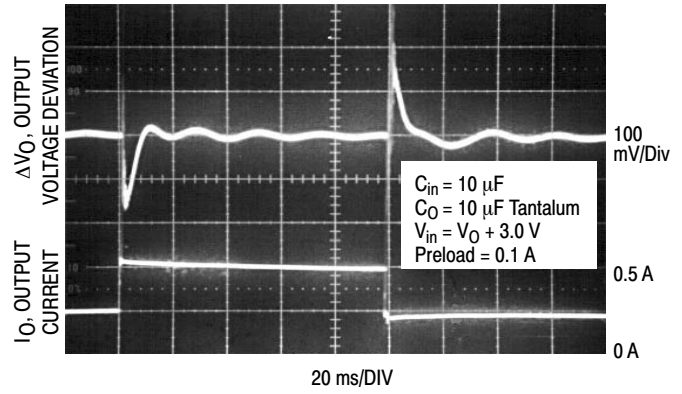

Figure 3. Transient Load Regulation

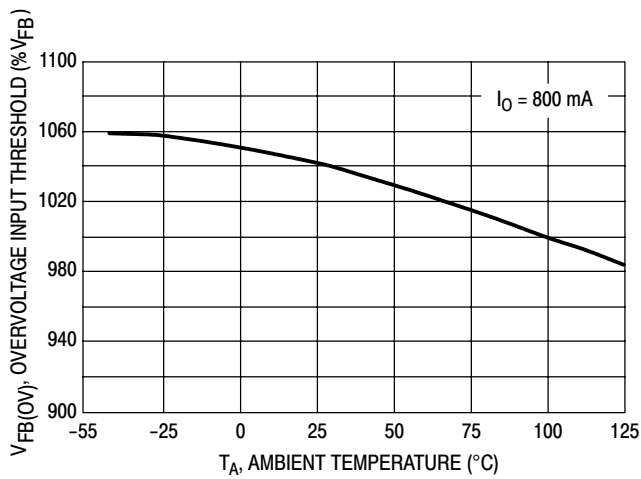

Figure 4. Dropout Voltage versus Temperature

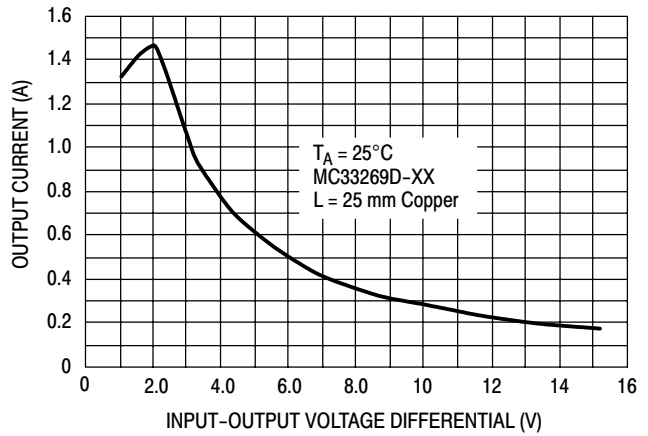

Figure 5. MC33269-XX Output DC Current versus Input-Output Differential Voltage

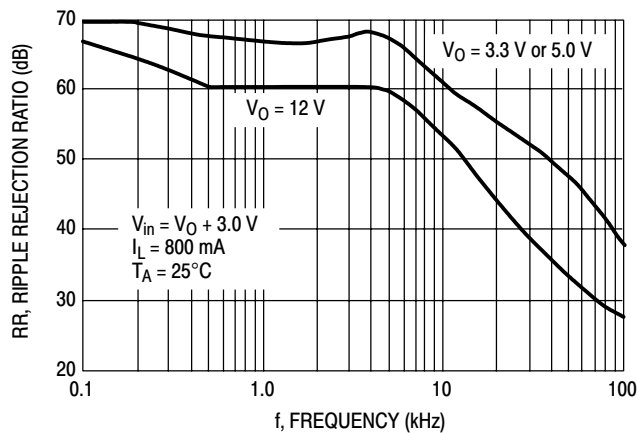

Figure 6. MC33269 Ripple Rejection versus Frequency

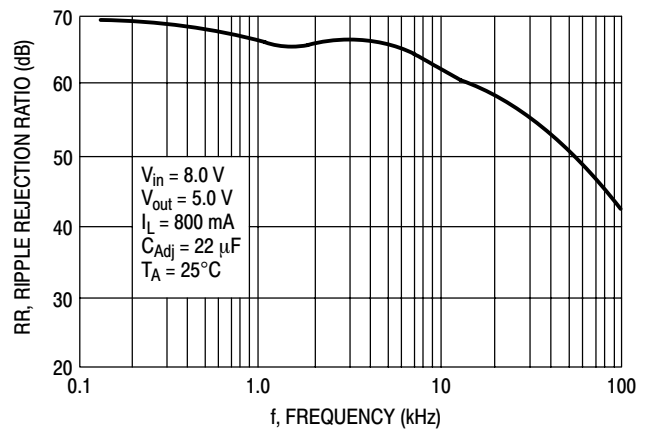

Figure 7. MC33269-ADJ Ripple Rejection versus Frequency

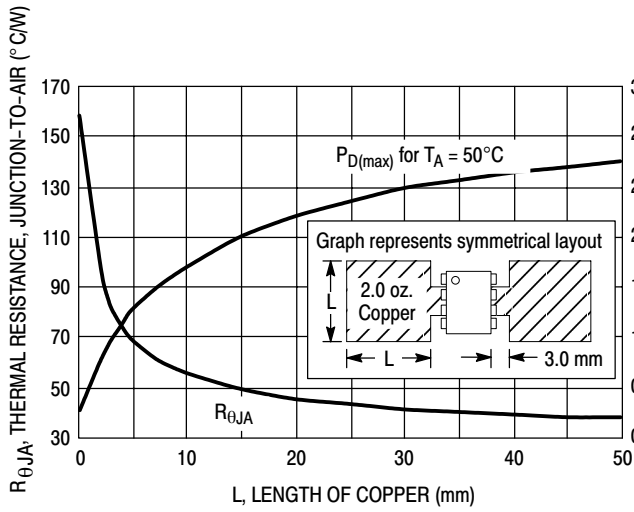

Figure 8. SOP-8 Thermal Resistance and Maximum Power Dissipation versus P.C.B. Copper Length

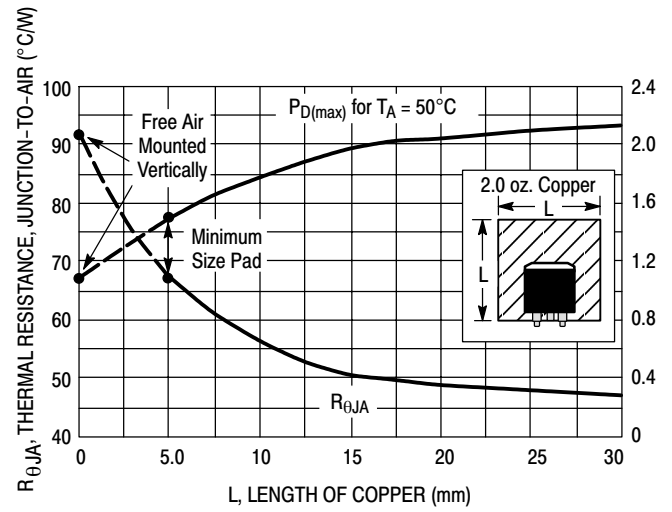

Figure 9. DPAK Thermal Resistance and Maximum Power Dissipation versus P.C.B. Copper Length

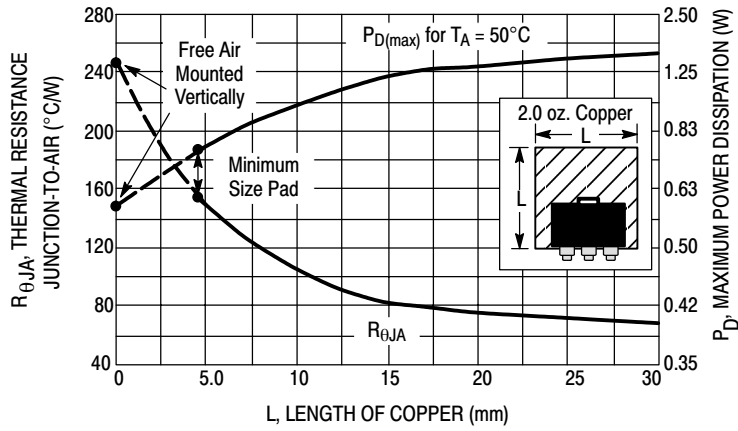

Figure 10. SOT-223 Thermal Resistance and Maximum Power Dissipation versus P.C.B. Copper Length

APPLICATIONS INFORMATION

Figures 11 through 15 are typical application circuits. The output current capability of the regulator is in excess of 800 mA, with a typical dropout voltage of less than 1.0 V. Internal protective features include current and thermal limiting.

* The MC33269 requires an external output capacitor for stability. The capacitor should be at least 10 μF with an equivalent series resistance (ESR) of less than 10 Ω but greater than 0.2 Ω over the anticipated operating temperature range. With economical electrolytic capacitors, cold temperature operation can pose a problem. As temperature decreases, the capacitance also decreases and the ESR increases, which could cause the circuit to oscillate. Also capacitance and ESR of a solid tantalum capacitor is more stable over temperature. The use of a low ESR ceramic capacitor placed within close proximity to the output of the device could cause instability.

** An input bypass capacitor is recommended to improve transient response or if the regulator is connected to the

supply input filter with long wire lengths. This will reduce the circuit's sensitivity to the input line impedance at high frequencies. A 0.33 μF or larger tantalum, mylar, ceramic, or other capacitor having low internal impedance at high frequencies should be chosen. The bypass capacitor should be mounted with shortest possible lead or track length directly across the regulator's input terminals. **Applications should be tested over all operating conditions to insure stability.**

Internal thermal limiting circuitry is provided to protect the integrated circuit in the event that the maximum junction temperature is exceeded. When activated, typically at 170°C, the output is disabled. There is no hysteresis built into the thermal limiting circuit. As a result, if the device is overheating, the output will appear to be oscillating. This feature is provided to prevent catastrophic failures from accidental device overheating. **It is not intended to be used as a substitute for proper heat-sinking.**

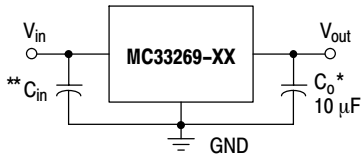

An input capacitor is not necessary for stability, however it will improve the overall performance.

Figure 11. Typical Fixed Output Application

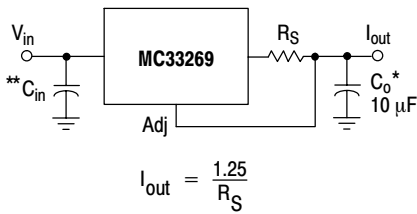

$$I_{out} = \frac{1.25}{R_S}$$

Figure 13. Current Regulator

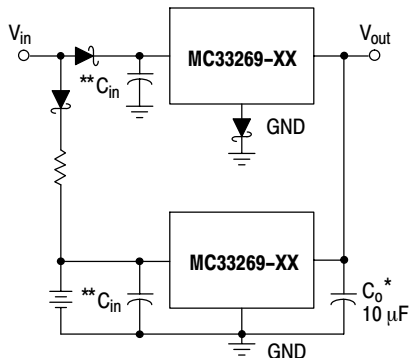

The Schottky diode in series with the ground leg of the upper regulator shifts its output voltage higher by the forward voltage drop of the diode. This will cause the lower device to remain off until the input voltage is removed.

Figure 14. Battery Backed-Up Power Supply

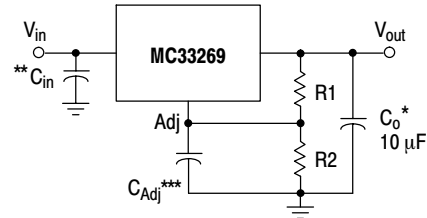

$$V_{out} = 1.25 \left(1 + \frac{R2}{R1} \right) + I_{Adj} R2$$

***C_{Adj} is optional, however it will improve the ripple rejection. The MC34269 develops a 1.25 V reference voltage between the output and the adjust terminal. Resistor R1, operates with constant current to flow through it and resistor R2. This current should be set such that the Adjust Pin current causes negligible drop across resistor R2. The total current with minimum load should be greater than 8.0 mA.

Figure 12. Typical Adjustable Output Application

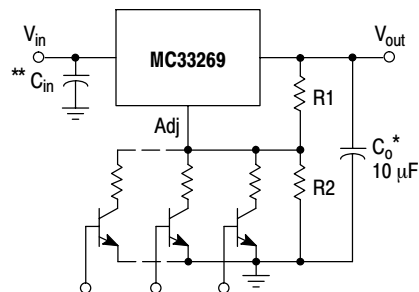

R₂ sets the maximum output voltage. Each transistor reduces the output voltage when turned on.

Figure 15. Digitally Controlled Voltage Regulator

MC33269, NCV33269

ORDERING INFORMATION

Device	Package	Shipping Information [†]
MC33269D	SO-8	98 Units / Rail
MC33269DR2	SO-8	2500 Units / Tape & Reel
MC33269DR2G	SO-8 (Pb-Free)	2500 Units / Tape & Reel
MC33269DT	DPAK	75 Units / Rail
MC33269DTG	DPAK (Pb-Free)	75 Units / Rail
MC33269DTRK	DPAK	2500 Units / Tape & Reel
MC33269DTRKG	DPAK (Pb-Free)	2500 Units / Tape & Reel
MC33269T	TO-220	50 Units / Rail
MC33269D-3.3	SO-8	98 Units / Rail
MC33269DR2-3.3	SO-8	2500 Units / Tape & Reel
MC33269DR2-3.3G	SO-8 (Pb-Free)	2500 Units / Tape & Reel
MC33269DT-3.3	DPAK	75 Units / Rail
MC33269DT-3.3G	DPAK (Pb-Free)	75 Units / Rail
MC33269DTRK-3.3	DPAK	2500 Units / Tape & Reel
MC33269DTRK-3.3G	DPAK (Pb-Free)	2500 Units / Tape & Reel
MC33269ST-3.3T3	SOT-223	4000 Units / Tape & Reel
MC33269ST-3.3T3G	SOT-223 (Pb-Free)	4000 Units / Tape & Reel
MC33269T-3.3	TO-220	50 Units / Rail
MC33269D-5.0	SO-8	98 Units / Rail
MC33269DR2-5.0	SO-8	2500 Units / Tape & Reel
MC33269DT-5.0	DPAK	75 Units / Rail
MC33269DTRK-5.0	DPAK	2500 Units / Tape & Reel
MC33269DTRK-5.0G	DPAK (Pb-Free)	2500 Units / Tape & Reel
MC33269T-5.0	TO-220	50 Units / Rail
MC33269D-12	SO-8	98 Units / Rail
MC33269DR2-12	SO-8	2500 Units / Tape & Reel
MC33269DT-12	DPAK	75 Units / Rail
MC33269DTRK-12	DPAK	2500 Units / Tape & Reel
MC33269DTRK-12G	DPAK (Pb-Free)	2500 Units / Tape & Reel
MC33269T-12	TO-220	50 Units / Rail
NCV33269DTRK*	DPAK	2500 Units / Tape & Reel
NCV33269DTRK-3.3*	DPAK	2500 Units / Tape & Reel
NCV33269DTRK-12*	DPAK	250 Units / Tape & Reel

[†]For information on tape and reel specifications, including part orientation and tape sizes, please refer to our Tape and Reel Packaging Specifications Brochure, BRD8011/D.

*NCV prefix is for automotive and other applications requiring site and control changes.

MC33269, NCV33269

MARKING DIAGRAMS

SO-8 D SUFFIX CASE 751

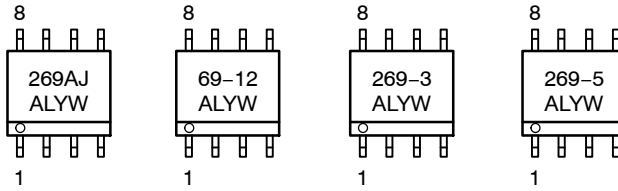

DPAK DT SUFFIX CASE 369A

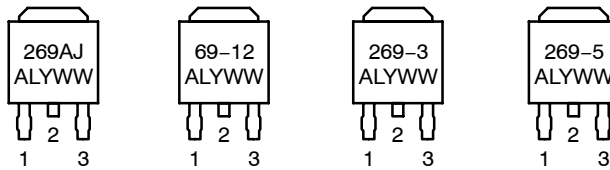

SOT-223 ST SUFFIX CASE 318E

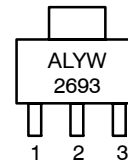

TO-220AB T SUFFIX CASE 221A

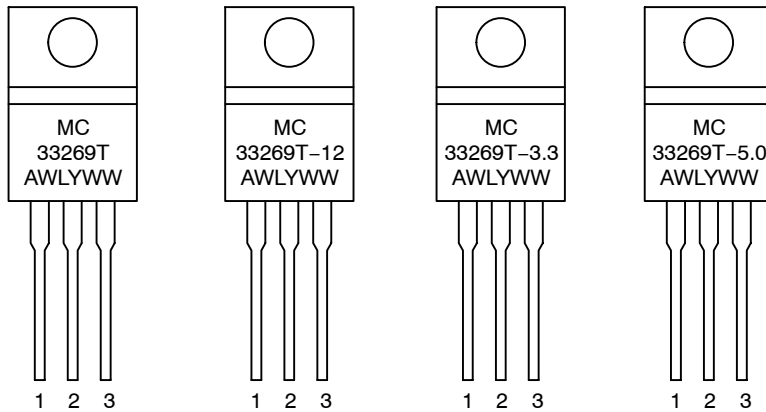

A = Assembly Location
 WL, L = Wafer Lot
 Y = Year
 WW, W = Work Week