

## **TPS23753AEVM-001 Evaluation Module for TPS23753A**

---



---

This user's guide describes the TPS23753A evaluation module (TPS23753AEVM-001). TPS23753AEVM-001 contains evaluation and reference circuitry for the TPS23753A. The TPS23753A device is an IEEE 802.3-2005 compliant, powered-device (PD) controller and power supply controller optimized for isolated converter topologies. TPS23753AEVM-001 is targeted at low-cost, simple, 7-W flyback converter applications.

### **Contents**

1	Description .....	2
	1.1 Features .....	2
	1.2 Applications .....	2
2	Electrical Specifications .....	2
3	Schematic .....	3
4	General Configuration and Description .....	4
	4.1 Physical Access .....	4
5	Test Setup .....	5
6	TPS23753AEVM-001 Typical Performance Data .....	5
	6.1 3.3-V Efficiency .....	5
	6.2 5-V DC/DC Efficiency .....	6
	6.3 TPS23753AEVM-001 Conducted Emissions .....	7
7	EVM Assembly Drawings and Layout Guidelines .....	7
	7.1 PCB Drawings .....	7
	7.2 Layout Guidelines .....	9
	7.3 EMI Containment .....	10
8	Bill of Materials .....	11

### **List of Figures**

1	TPS23753AEVM-001 Schematic .....	3
2	Typical TPS23753AEVM-001 Test Setup .....	5
3	TPS23753AEVM-002 Efficiency With 3.3-V Output .....	6
4	TPS23753AEVM-001 Efficiency With 5-V Output .....	6
5	TPS23753AEVM-001 Conducted Emissions .....	7
6	Top-Side Placement .....	7
7	Top-Side Routing .....	8
8	Bottom-Side Routing .....	8
9	Bottom-Side Placement .....	9

### **List of Tables**

1	TPS23753AEVM-001 and -002 Electrical and Performance Specifications at T=25°C .....	2
2	Connector Functionality .....	4
3	Test Points .....	4
4	TPS23753AEVM-001 and -002 Bill of Materials .....	11

## 1 Description

The TPS23753AEVM-001 allows reference circuitry evaluation of the TPS23753A. It contains input and output power connectors and an array of onboard test points for circuit evaluation. TPS23753AEVM-002 (3.3-V output) can be configured with simple bill of materials (BOM) changes.

### 1.1 Features

- Low-cost, basic design
  - Simple gate drive, Shottky diode rectified secondary
  - 7-W output power from power over ethernet (PoE), 48-V or 24-V adapter and 4-W output power from a 12-V adapter
  - 3.3-V output voltage with simple BOM changes

### 1.2 Applications

- Voice over Internet protocol – IP telephones
- Wireless LAN – wireless access points
- Security – wired IP cameras

## 2 Electrical Specifications

**Table 1. TPS23753AEVM-001 and -002 Electrical and Performance Specifications at T=25°C**

PARAMETER	TEST CONDITIONS	MIN	TYP	MAX	UNIT	
<b>POWER INTERFACE</b>						
Input voltage	Applied to the power pins of connectors J2 or J4	0		57	V	
Operating voltage	After start-up	30		57	V	
Input UVLO	Rising input voltage			36	V	
	Falling input voltage	30				
Detection voltage	At device terminals	3		10	mA	
Classification voltage	At device terminals	10		23	mA	
Classification current	Rclass = 1270 Ω	1.8		2.4	mA	
Inrush current-limit		90		190	mA	
Operating current-limit		405		495	mA	
<b>DC/DC CONVERTER</b>						
Output voltage	20 V ≤ Vin ≤ 57 V, ILOAD ≤ ILOAD (max) 10.8 V ≤ Vin ≤ 13.2 V, ILOAD ≤ ILOAD (max)	3.3-V output (-002)	3.13	3.3	3.47	V
		5-V output (-001)	4.75	5	5.25	
Output current	20 V ≤ Vin ≤ 57 V	3.3-V output			2	A
					1.4	
Output current	10.8 V ≤ Vin ≤ 13.2 V	5-V output			1.2	A
					0.8	
Output ripple voltage, peak-to-peak	Vin = 44 V, ILOAD = 2 A	3.3-V output		65	mV	
	Vin = 44 V, ILOAD = 1.4 A	5-V output		50		
Efficiency, end-to-end	Vin = 44 V, ILOAD = 2 A	3.3-V output		77	%	
	Vin = 44 V, ILOAD = 1.4 A	5-V output		80	%	
Switching frequency			225	270	kHz	

3 Schematic

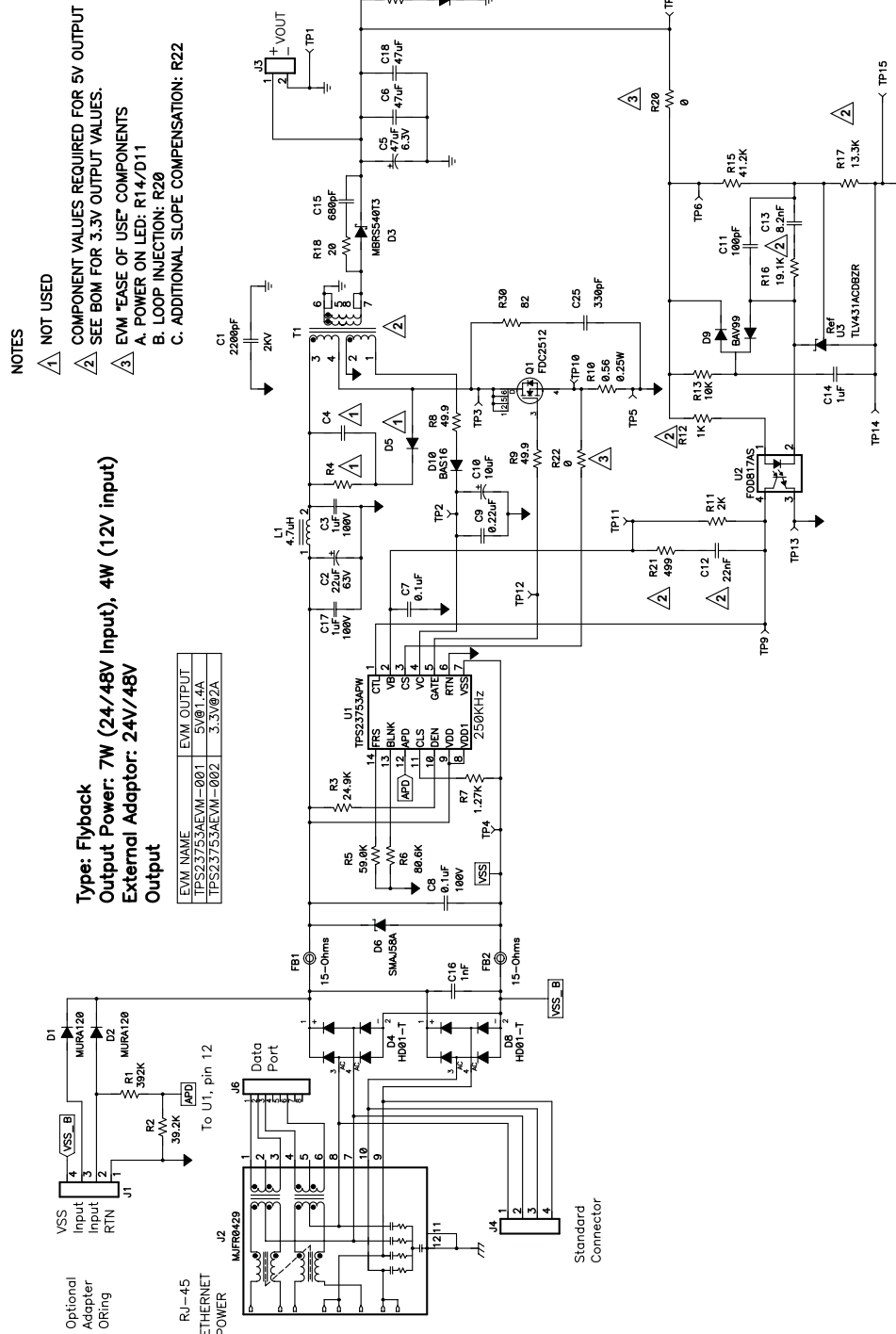

Figure 1. TPS23753AEVM-001 Schematic

## 4 General Configuration and Description

### 4.1 Physical Access

Table 2 lists the TPS23753AEVM-001 connector functionality and Table 3 describes the test point availability.

**Table 2. Connector Functionality**

Connector	Label	Description
J1	RTN Input Input VSS	External adapter input connector. J1-1/J1-2 are used with DC/DC converter adapter input (RTN) and J1-3/J1-4 are used with a PD adapter input (VSS)
J2	ETHERNET POWER	Ethernet power input connector. Contains Ethernet transformer and cable terminations
J3	VOUT	Output voltage connector
J4	12 36 45 78	PD side diode bridge input. Used to apply 48-V input voltage to the diode bridges as would power application from the J2 connector. J4-1/J4-2 and J4-3/J4-4 are used together.
J6	DATA PORT	Ethernet data port connector

**Table 3. Test Points**

Test Point	Color	Label	Description
TP1, TP14, TP15	BLK	GND	Secondary-side (output) grounds (GND)
TP2	RED	VC	DC/DC converter bias supply
TP3	ORG	DRAIN	Drain terminal of the primary-side switching MOSFET
TP4	BLK	VSS	PoE input, low side
TP5, TP13	BLK	RTN	DC/DC converter return
TP6	ORG	LOOP	Can be used with TP8 for feedback loop measurements.
TP8	RED	VOUT	DC/DC converter output voltage.
TP9	RED	CTL	Control loop input to the pulse width modulator
TP10	WHT	CS	DC/DC converter primary-side switching MOSFET current-sense input
TP11	RED	VB	Bias voltage regulator
TP12	WHT	GATE	Gate drive for the primary-side switching MOSFET
D11	RED	POWER ON	Output power indicator

## 5 Test Setup

Figure 2 shows a typical test setup for TPS23753AEVM-001. Input voltage can be applied as described in Table 2.

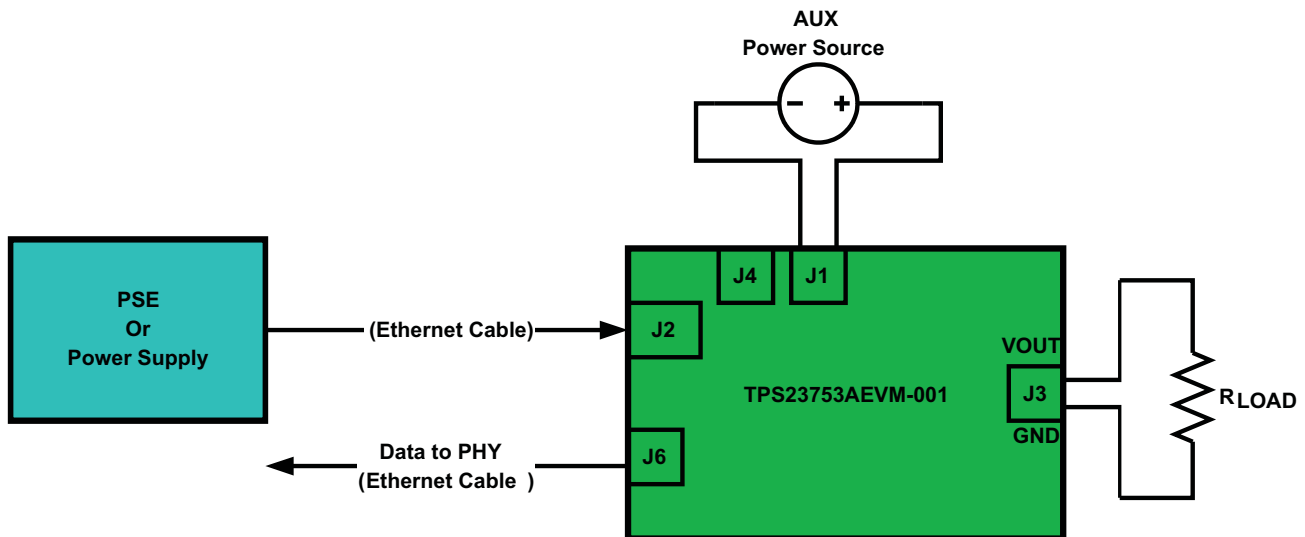

Figure 2. Typical TPS23753AEVM-001 Test Setup

## 6 TPS23753AEVM-001 Typical Performance Data

### 6.1 3.3-V Efficiency

Figure 3 illustrates the efficiency at three different input voltage levels: 1) PoE 48 V from J2, 2) 48 V RTN-based adapter, and 3) 24-V RTN-based adapter.

---

**NOTE:** TPS23753AEVM-001 contains options for two different type primary switch snubbers. An RC slew rate snubber is included by default but if additional efficiency is demanded by the application, the RC snubber may be removed and the clamp type snubber may be populated. The RC snubber is best for applications requiring low conducted emissions via the power lines.

---

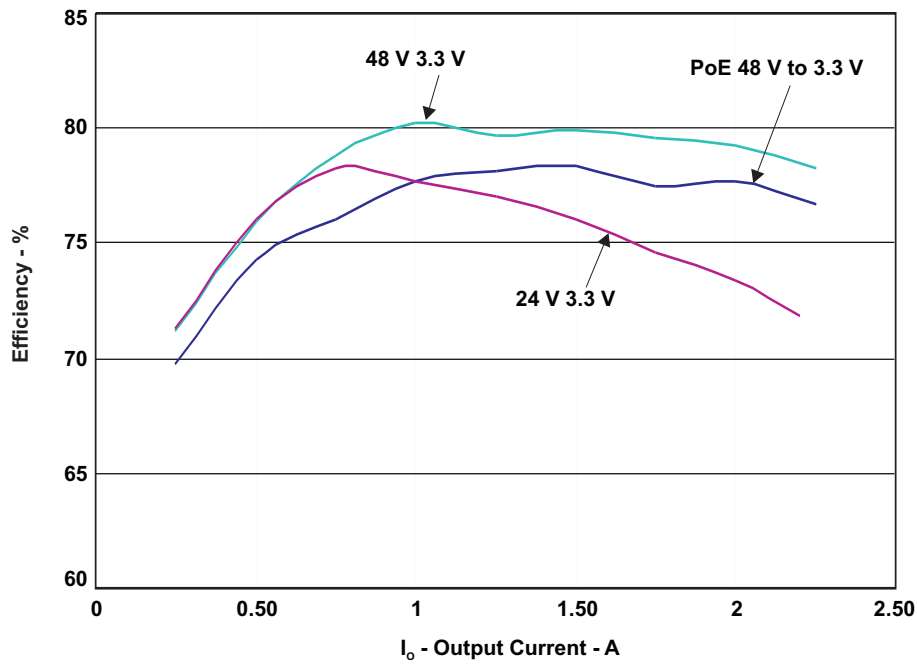

Figure 3. TPS23753AEVM-002 Efficiency With 3.3-V Output

## 6.2 5-V DC/DC Efficiency

Figure 4 illustrates the efficiency at three different input voltage levels: 1) PoE 48 V from J2, 2) 48 V RTN-based adapter, and 3) 24-V RTN-based adapter.

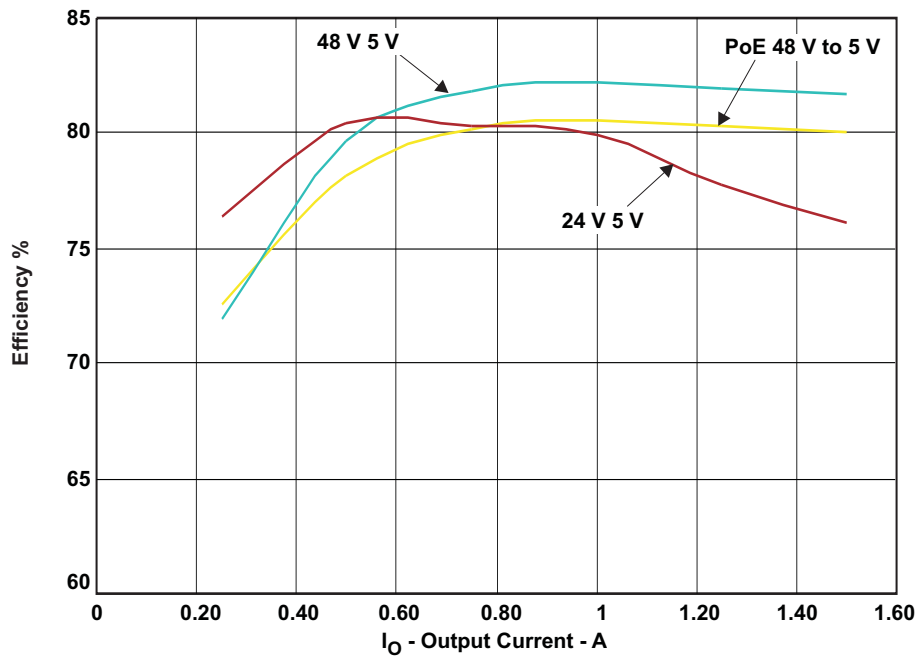

Figure 4. TPS23753AEVM-001 Efficiency With 5-V Output

### 6.3 TPS23753AEVM-001 Conducted Emissions

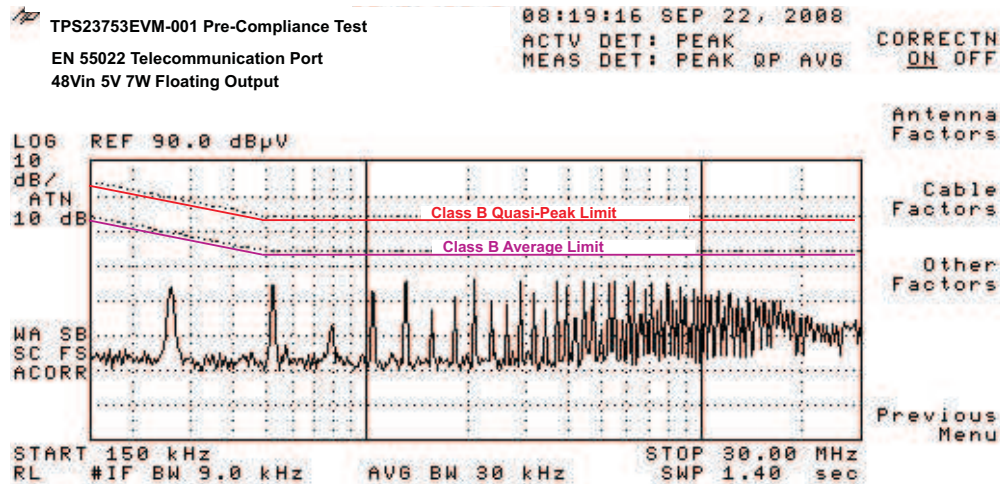

Figure 5. TPS23753AEVM-001 Conducted Emissions

## 7 EVM Assembly Drawings and Layout Guidelines

### 7.1 PCB Drawings

Figure 6 through Figure 9 show component placement and layout.

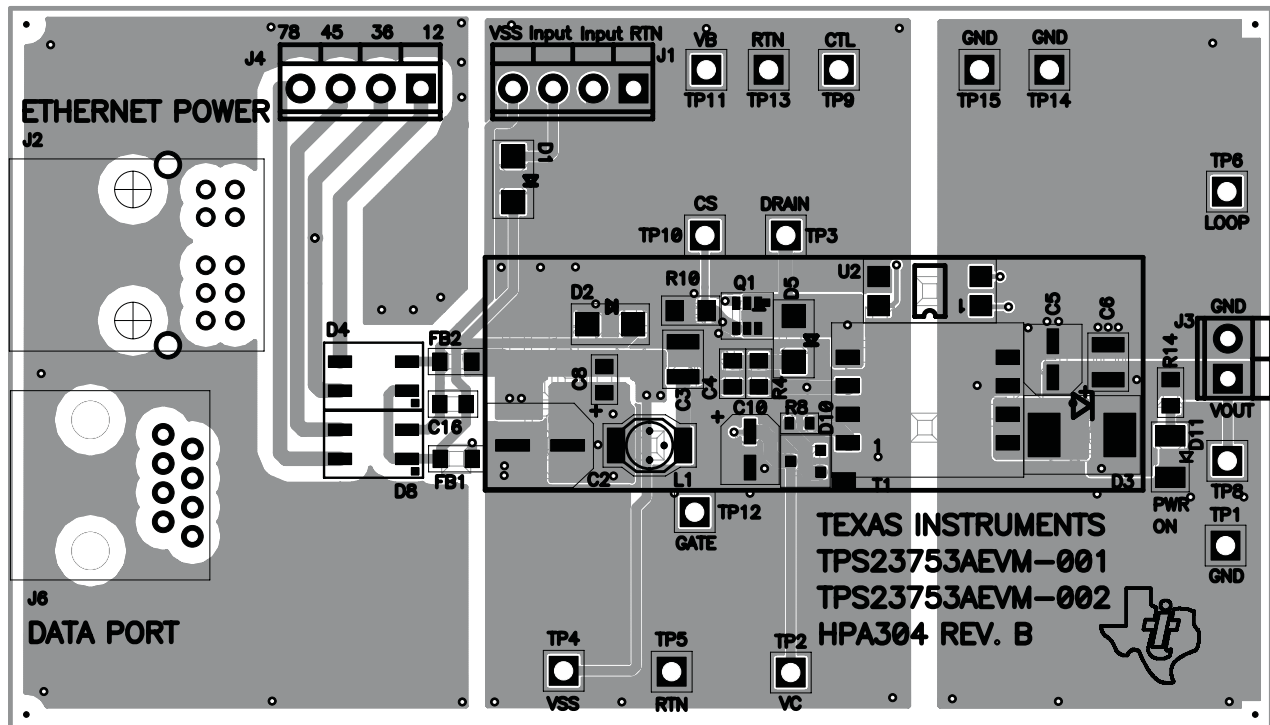
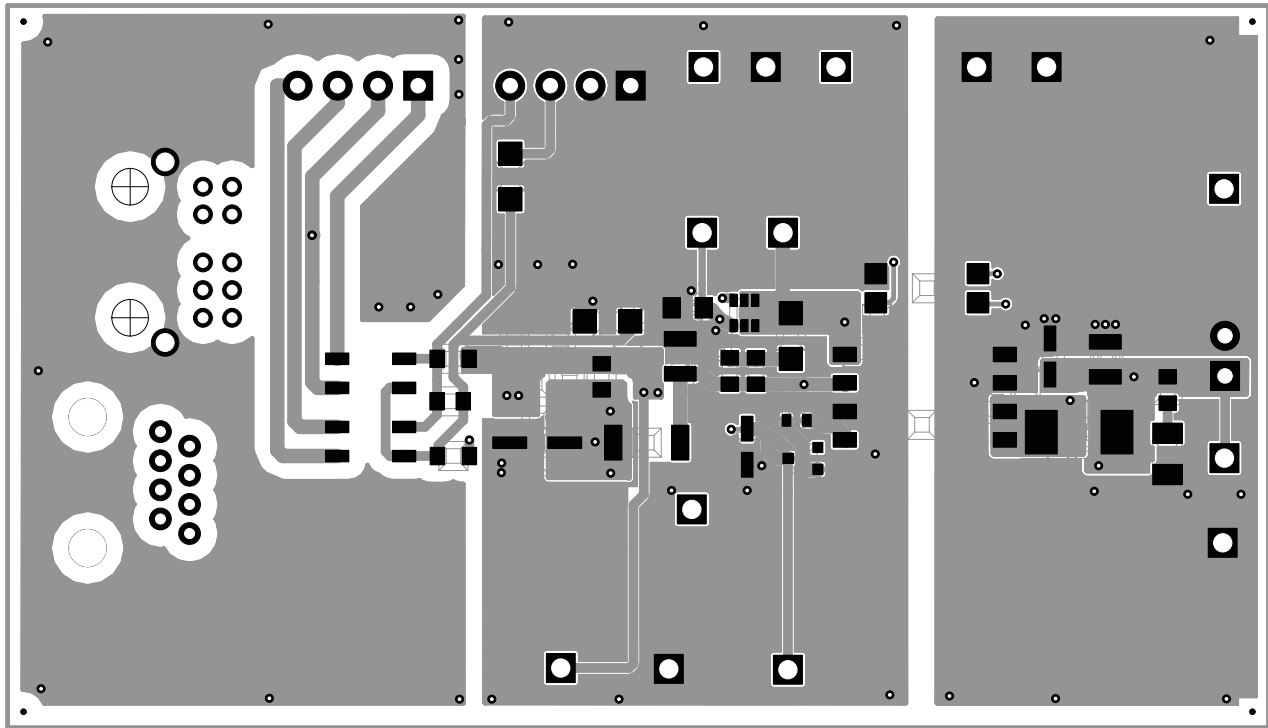
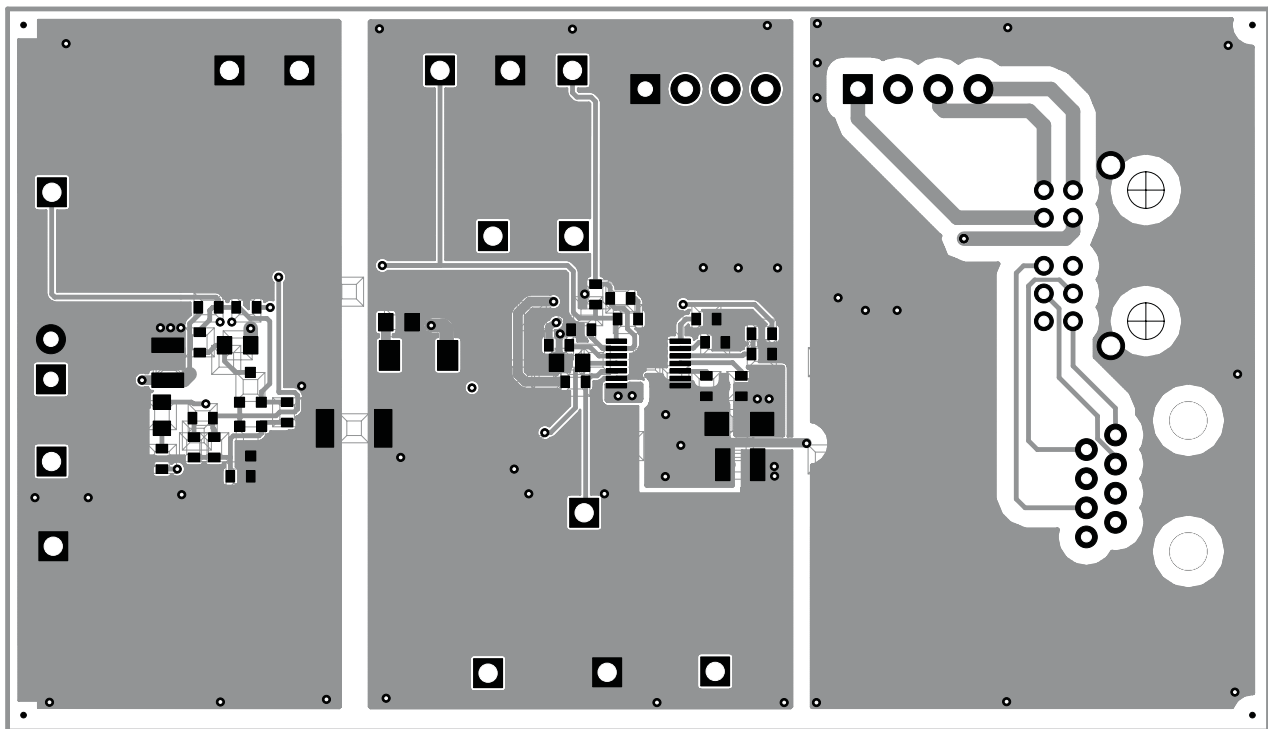

Figure 6. Top-Side Placement

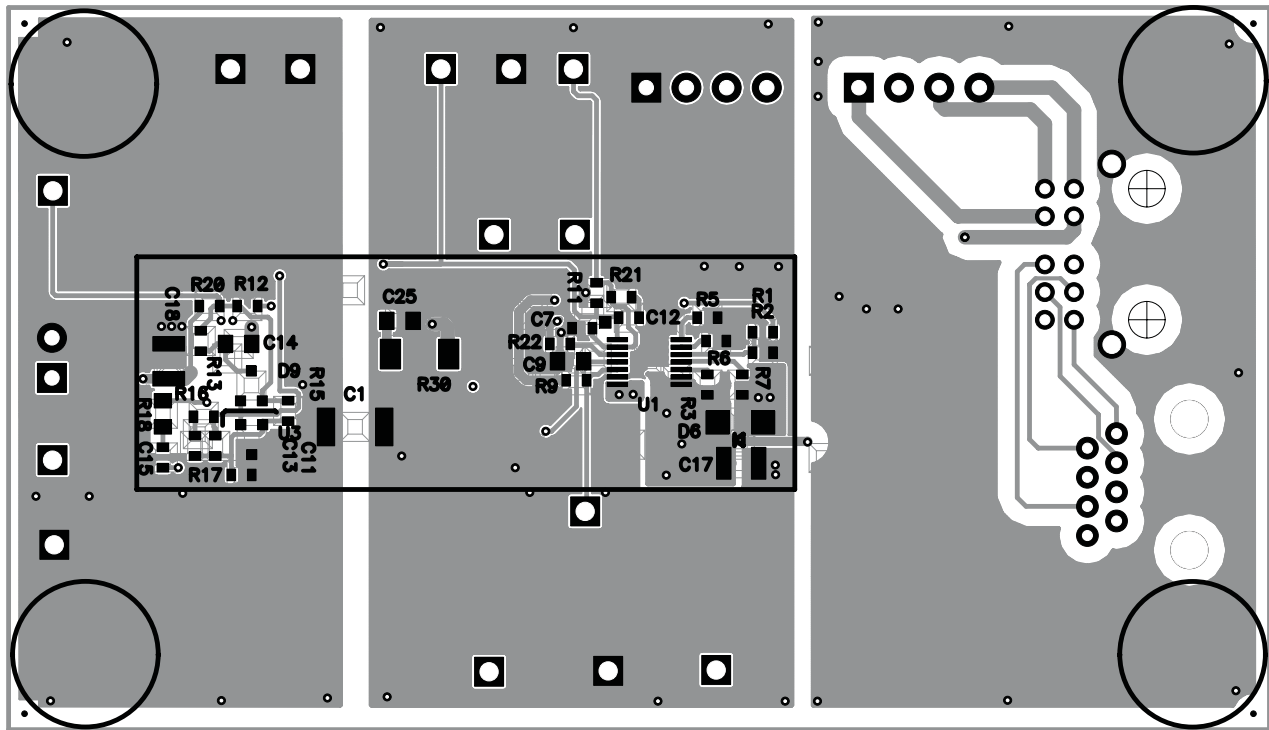

**Figure 7. Top-Side Routing**



**Figure 8. Bottom-Side Routing**





**Figure 9. Bottom-Side Placement**

## 7.2 Layout Guidelines

The layout of the PoE front end should follow power and EMI/ESD best-practice guidelines. A basic set of recommendations include:

- Parts placement must be driven by power flow in a point-to-point manner; RJ-45, Ethernet transformer, diode bridges, TVS and 0.1- $\mu$ F capacitor, and TPS23753A converter input bulk capacitor.
- Make all leads as short as possible with wide power traces and paired signal and return.
- No crossovers of signals from one part of the flow to another are allowed.
- Spacing consistent with safety standards like IEC60950 must be observed between the 48-V input voltage rails and between the input and an isolated converter output.
- Place the TPS23753A over split, local ground planes referenced to  $V_{SS}$  for the PoE input and to COM/RTN for the converter. Whereas the PoE side may operate without a ground plane, the converter side must have one. Do not place logic ground and power layers under the Ethernet input or the converter primary side.
- Use large copper fills and traces on SMT power-dissipating devices, and use wide traces or overlay copper fills in the power path.

The DC/DC Converter layout benefits from basic rules such as:

- Pair signals to reduce emissions and noise, especially the paths that carry high-current pulses which include the power semiconductors and magnetics.
- Minimize trace length of high current, power semiconductors, and magnetic components.
- Where possible, use vertical pairing
- Use the ground plane for the switching currents carefully.
- Keep the high-current and high-voltage switching away from low-level sensing circuits including those outside the power supply.
- Proper spacing around the high-voltage sections of the converter

### 7.3 EMI Containment

- Use compact loops for dv/dt and di/dt circuit paths (power loops and gate drives)
- Use minimal, yet thermally adequate, copper areas for heat sinking of components tied to switching nodes (minimize exposed radiating surface).
- Use copper ground planes (possible stitching) and top-layer copper floods (surround circuitry with ground floods)
- Use a 4-layer PCB, if economically feasible (for better grounding)
- Minimize the amount of copper area associated with input traces (to minimize radiated pickup)
- Hide copper associated with switching nodes under shielded magnetics, where possible
- Heat sink the *quiet side* of components instead of the *switching side*, where possible (like the output side of inductor)
- Use Bob Smith terminations, Bob Smith EFT capacitor, and Bob Smith plane
- Use Bob Smith plane as ground shield on input side of PCB (creating a phantom or literal earth ground)
- Use LC filter at DC/DC input
- Dampen high-frequency ringing on all switching nodes, if present (allow for possible snubbers)
- Control rise times with gate-drive resistors and possibly snubbers
- Switching frequency considerations
- Use of EMI bridge capacitor across isolation boundary (isolated topologies)
- Observe the polarity dot on inductors (embed noisy end)
- Use of ferrite beads on input (allow for possible use of beads or 0- $\Omega$  resistors)
- Maintain physical separation between input-related circuitry and power circuitry (use ferrite beads as boundary line)
- Balance efficiency versus acceptable noise margin
- Possible use of common-mode inductors
- Possible use of integrated RJ-45 jacks (shielded with internal transformer and Bob Smith terminations)
- End-product enclosure considerations (shielding)

## 8 Bill of Materials

**Table 4. TPS23753AEVM-001 and -002 Bill of Materials**

TPS23753AEVM-X		RefDes	Value	Description	Size	Part Number	MFR
Outputs (V)							
3.3	5						
Count							
X=002	X=001						
1	1	C1	2200pF	Capacitor, Ceramic, 2KV, X7R, 10%	1812	C4532X7R3D222K	TDK
1	1	C10	10uF	Capacitor, Aluminum, 16V, ±20%	0.200 × 0.210 in	EEVFK1E100R	Panasonic
1	1	C11	100pF	Capacitor, Ceramic, 50V, C0G, 5%	0603	Std	Std
0	1	C12	22nF	Capacitor, Ceramic, 50V, X7R, 10%	0603	Std	Std
1	0	C12	47nF	Capacitor, Ceramic, 50V, X7R, 10%	0603	Std	Std
0	1	C13	8.2nF	Capacitor, Ceramic, 50V, X7R, 10%	0603	Std	Std
1	0	C13	6.8nF	Capacitor, Ceramic, 50V, X7R, 10%	0603	Std	Std
1	1	C14	1uF	Capacitor, Ceramic, 16V, X7R, 10%	0805	Std	Std
1	1	C15	680pF	Capacitor, Ceramic, 25V, X7R, 10%	0603	Std	Std
1	1	C16	1nF	Capacitor, Ceramic, 100V, X7R, 10%	0805	Std	Std
1	1	C2	22µF	Capacitor, Aluminum, 63V, ±20%	0.260 × 0.276 in	EEVFK1J220XP	Panasonic
1	1	C25	330pF	Capacitor, Ceramic, 200V, X7R, 10%	0805	Std	Std
2	2	C3, C17	1µF	Capacitor, Ceramic, 100V, X7R, 10%	1210	Std	Std
0	0	C4	10nF	Capacitor, Ceramic, 100V, X7R, 10%	0805	Std	Std
1	1	C5	47µF	Capacitor, Aluminum, 6.3V, ±20%	0.200 × 0.210 in	EEVFK0J470UR	Panasonic
2	2	C6, C18	47µF	Capacitor, Ceramic, 10V, X5R, 20%	1210	Std	TDK
1	1	C7	0.1µF	Capacitor, Ceramic, 50V, X7R, 10%	0603	Std	Std
1	1	C8	0.1µF	Capacitor, Ceramic, 100V, X7R, 10%	0805	Std	Std
1	1	C9	0.22µF	Capacitor, Ceramic, 25V, X7R, 10%	0805	Std	Std
2	2	D1, D2	MURA120	Diode, Rectifier, 1A, 200V	SMA	MURA120	On Semi
0	0	D5	MURA120	Diode, Rectifier, 1A, 200V	SMA	MURA120	On Semi
1	1	D10	BAS16	Diode, Switching, 150-mA, 75-V, 350mW	SOT23	BAS16	Fairchild
1	1	D3	MBRS540T3	Diode, Schottky, 5-A, 40-V	SMC	MBRS540T3	On Semi
2	2	D4, D8	HD01-T	Bridge Rectifier, 100V, 0.8A	MINI DIP4	HD01-T	Diodes, Inc
1	1	D6	SMAJ58A	Diode, TVS, 58-V, 1W	SMA	SMAJ58A	Diodes Inc.
1	1	D9	BAV99	Diode, Dual Ultra Fast, Series, 200-mA, 70-V	SOT23	BAV99	Fairchild
2	2	FB1,FB2	15-Ω	Bead, Ferrite, SMT, 15-Ω, 1500mA	0805	MMZ2012R150A	TDK
2	2	J1, J4	ED555/4DS	Terminal Block, 4-pin, 6-A, 3.5mm	0.55 × 0.25 in	ED555/4DS	OST
1	1	J2	MJFR0429	Connector, Module, RJ45	0.855 × 0.620	MJFR0429	E&E Magnetic Products
1	1	J3	ED1514	Terminal Block, 2-pin, 6-A, 3.5mm	0.27 × 0.25	ED1514	
1	1	J6	5520252-4	Connector, Jack Modular, Rt. Angle,	0.655 × 0.615 in	5520252-4	AMP

**Table 4. TPS23753AEVM-001 and -002 Bill of Materials (continued)**

TPS23753AEVM-X		RefDes	Value	Description	Size	Part Number	MFR
Outputs (V)							
3.3	5						
Count							
X=002	X=001						
1	1	L1	4.7µH	Inductor, SMT, 1.5A, 90-mΩ	0.26 × 0.09 in	DO1608C-472ML	Coilcraft
1	1	Q1	FDC2512	MOSFET, N-ch, 150-V, 1.4-A, 425-mΩ	SSOT-6	FDC2512	Fairchild
1	1	R1	392K	Resistor, Chip, 1/16W, 1%	0603	Std	Std
1	1	R10	0.56	Resistor, Chip, 1/4W, 1%	1206	ERJ-8RQFR56V	Panasonic ECG
1	1	R11	2K	Resistor, Chip, 1/16W, 1%	0603	Std	Std
0	1	R12	1K	Resistor, Chip, 1/16W, 1%	0603	Std	Std
1	0	R12	402	Resistor, Chip, 1/16W, 1%	0603	Std	Std
1	1	R13	10K	Resistor, Chip, 1/16W, 1%	0603	Std	Std
1	1	R15	41.2K	Resistor, Chip, 1/16W, 1%	0603	Std	Std
0	1	R16	19.1K	Resistor, Chip, 1/16W, 1%	0603	Std	Std
1	0	R16	7.15K	Resistor, Chip, 1/16W, 1%	0603	Std	Std
0	1	R17	13.3K	Resistor, Chip, 1/16W, 1%	0603	Std	Std
1	0	R17	24.3K	Resistor, Chip, 1/16W, 1%	0603	Std	Std
1	1	R18	20	Resistor, Chip, 1/10W, 5%	0805	Std	Std
1	1	R2	39.2K	Resistor, Chip, 1/16W, 1%	0603	Std	Std
2	2	R20, R22	0	Resistor, Chip, 1/16W, 1%	0603	Std	Std
0	1	R21	499	Resistor, Chip, 1/16W, 1%	0603	Std	Std
1	0	R21	402	Resistor, Chip, 1/16W, 1%	0603	Std	Std
1	1	R3	24.9K	Resistor, Chip, 1/16W, 1%	0603	Std	Std
1	1	R30	82	Resistor, Chip, 1/2W, 5%	2010	Std	Std
0	0	R4	49.9K	Resistor, Chip, 1/10W, 1%	0805	Std	Std
1	1	R5	59.0K	Resistor, Chip, 1/16W, 1%	0603	Std	Std
1	1	R6	80.6K	Resistor, Chip, 1/16W, 1%	0603	Std	Std
1	1	R7	1.27K	Resistor, Chip, 1/16W, 1%	0603	Std	Std
2	2	R8, R9	49.9	Resistor, Chip, 1/16W, 1%	0603	Std	Std
0	1	T1	POE70P-50L or 835-01046FC	Transformer, PoE 7W, 155 µH. 5V, 1.4A Output	0.500 × 0.600 in	POE70P-50L or 835-01046FC	Coilcraft or E&E Magnetic Products
1	0	T1	POE70P-33L or 835-01045FC	Transformer, PoE 7W, 155 µH. 3.3V, 2.1A Output	0.500 × 0.600 in	POE70P-33L or 835-01045FC	Coilcraft or E&E Magnetic Products
1	1	U1	TPS23753APW	IC, IEEE 802.3-2005 Integrated Primary Side Controller	TSSOP14	TPS23753APW	TI
1	1	U2	FOD817AS	IC, Optocoupler, 6-V, 80-160% CTR	SMT-4PDIP	FOD817AS	Fairchild
1	1	U3	TLV431ACDBZR	IC, Low-Voltage Adjustable Shunt Regulator	SOT23-3	TLV431ACDBZR	TI
1	1	—	—	PCB, 2.48 In × 4.33 In × 0.062 In	—	HPA304	Any

## Revision History

<b>Changes from Original (June 2009) to A Revision</b>	<b>Page</b>
• Added the Layout Guidelines section.....	9
• Added the EMI Containment section.....	10

---

NOTE: Page numbers for previous revisions may differ from page numbers in the current version.

## ADDITIONAL TERMS AND CONDITIONS, WARNINGS, RESTRICTIONS, AND DISCLAIMERS FOR EVALUATION MODULES

Texas Instruments Incorporated (TI) markets, sells, and loans all evaluation boards, kits, and/or modules (EVMs) pursuant to, and user expressly acknowledges, represents, and agrees, and takes sole responsibility and risk with respect to, the following:

1. User agrees and acknowledges that EVMs are intended to be handled and used for feasibility evaluation only in laboratory and/or development environments. Notwithstanding the foregoing, in certain instances, TI makes certain EVMs available to users that do not handle and use EVMs solely for feasibility evaluation only in laboratory and/or development environments, but may use EVMs in a hobbyist environment. All EVMs made available to hobbyist users are FCC certified, as applicable. Hobbyist users acknowledge, agree, and shall comply with all applicable terms, conditions, warnings, and restrictions in this document and are subject to the disclaimer and indemnity provisions included in this document.
2. Unless otherwise indicated, EVMs are not finished products and not intended for consumer use. EVMs are intended solely for use by technically qualified electronics experts who are familiar with the dangers and application risks associated with handling electrical mechanical components, systems, and subsystems.
3. User agrees that EVMs shall not be used as, or incorporated into, all or any part of a finished product.
4. User agrees and acknowledges that certain EVMs may not be designed or manufactured by TI.
5. User must read the user's guide and all other documentation accompanying EVMs, including without limitation any warning or restriction notices, prior to handling and/or using EVMs. Such notices contain important safety information related to, for example, temperatures and voltages. For additional information on TI's environmental and/or safety programs, please visit [www.ti.com/esh](http://www.ti.com/esh) or contact TI.
6. User assumes all responsibility, obligation, and any corresponding liability for proper and safe handling and use of EVMs.
7. Should any EVM not meet the specifications indicated in the user's guide or other documentation accompanying such EVM, the EVM may be returned to TI within 30 days from the date of delivery for a full refund. THE FOREGOING LIMITED WARRANTY IS THE EXCLUSIVE WARRANTY MADE BY TI TO USER AND IS IN LIEU OF ALL OTHER WARRANTIES, EXPRESSED, IMPLIED, OR STATUTORY, INCLUDING ANY WARRANTY OF MERCHANTABILITY OR FITNESS FOR ANY PARTICULAR PURPOSE. TI SHALL NOT BE LIABLE TO USER FOR ANY INDIRECT, SPECIAL, INCIDENTAL, OR CONSEQUENTIAL DAMAGES RELATED TO THE HANDLING OR USE OF ANY EVM.
8. No license is granted under any patent right or other intellectual property right of TI covering or relating to any machine, process, or combination in which EVMs might be or are used. TI currently deals with a variety of customers, and therefore TI's arrangement with the user is not exclusive. TI assumes no liability for applications assistance, customer product design, software performance, or infringement of patents or services with respect to the handling or use of EVMs.
9. User assumes sole responsibility to determine whether EVMs may be subject to any applicable federal, state, or local laws and regulatory requirements (including but not limited to U.S. Food and Drug Administration regulations, if applicable) related to its handling and use of EVMs and, if applicable, compliance in all respects with such laws and regulations.
10. User has sole responsibility to ensure the safety of any activities to be conducted by it and its employees, affiliates, contractors or designees, with respect to handling and using EVMs. Further, user is responsible to ensure that any interfaces (electronic and/or mechanical) between EVMs and any human body are designed with suitable isolation and means to safely limit accessible leakage currents to minimize the risk of electrical shock hazard.
11. User shall employ reasonable safeguards to ensure that user's use of EVMs will not result in any property damage, injury or death, even if EVMs should fail to perform as described or expected.
12. User shall be solely responsible for proper disposal and recycling of EVMs consistent with all applicable federal, state, and local requirements.

**Certain Instructions.** User shall operate EVMs within TI's recommended specifications and environmental considerations per the user's guide, accompanying documentation, and any other applicable requirements. Exceeding the specified ratings (including but not limited to input and output voltage, current, power, and environmental ranges) for EVMs may cause property damage, personal injury or death. If there are questions concerning these ratings, user should contact a TI field representative prior to connecting interface electronics including input power and intended loads. Any loads applied outside of the specified output range may result in unintended and/or inaccurate operation and/or possible permanent damage to the EVM and/or interface electronics. Please consult the applicable EVM user's guide prior to connecting any load to the EVM output. If there is uncertainty as to the load specification, please contact a TI field representative. During normal operation, some circuit components may have case temperatures greater than 60°C as long as the input and output are maintained at a normal ambient operating temperature. These components include but are not limited to linear regulators, switching transistors, pass transistors, and current sense resistors which can be identified using EVMs' schematics located in the applicable EVM user's guide. When placing measurement probes near EVMs during normal operation, please be aware that EVMs may become very warm. As with all electronic evaluation tools, only qualified personnel knowledgeable in electronic measurement and diagnostics normally found in development environments should use EVMs.

**Agreement to Defend, Indemnify and Hold Harmless.** User agrees to defend, indemnify, and hold TI, its directors, officers, employees, agents, representatives, affiliates, licensors and their representatives harmless from and against any and all claims, damages, losses, expenses, costs and liabilities (collectively, "Claims") arising out of, or in connection with, any handling and/or use of EVMs. User's indemnity shall apply whether Claims arise under law of tort or contract or any other legal theory, and even if EVMs fail to perform as described or expected.

**Safety-Critical or Life-Critical Applications.** If user intends to use EVMs in evaluations of safety critical applications (such as life support), and a failure of a TI product considered for purchase by user for use in user's product would reasonably be expected to cause severe personal injury or death such as devices which are classified as FDA Class III or similar classification, then user must specifically notify TI of such intent and enter into a separate Assurance and Indemnity Agreement.

## RADIO FREQUENCY REGULATORY COMPLIANCE INFORMATION FOR EVALUATION MODULES

Texas Instruments Incorporated (TI) evaluation boards, kits, and/or modules (EVMs) and/or accompanying hardware that is marketed, sold, or loaned to users may or may not be subject to radio frequency regulations in specific countries.

### General Statement for EVMs Not Including a Radio

For EVMs not including a radio and not subject to the U.S. Federal Communications Commission (FCC) or Industry Canada (IC) regulations, TI intends EVMs to be used only for engineering development, demonstration, or evaluation purposes. EVMs are not finished products typically fit for general consumer use. EVMs may nonetheless generate, use, or radiate radio frequency energy, but have not been tested for compliance with the limits of computing devices pursuant to part 15 of FCC or the ICES-003 rules. Operation of such EVMs may cause interference with radio communications, in which case the user at his own expense will be required to take whatever measures may be required to correct this interference.

### General Statement for EVMs including a radio

*User Power/Frequency Use Obligations:* For EVMs including a radio, the radio included in such EVMs is intended for development and/or professional use only in legally allocated frequency and power limits. Any use of radio frequencies and/or power availability in such EVMs and their development application(s) must comply with local laws governing radio spectrum allocation and power limits for such EVMs. It is the user's sole responsibility to only operate this radio in legally acceptable frequency space and within legally mandated power limitations. Any exceptions to this are strictly prohibited and unauthorized by TI unless user has obtained appropriate experimental and/or development licenses from local regulatory authorities, which is the sole responsibility of the user, including its acceptable authorization.

### U.S. Federal Communications Commission Compliance

#### For EVMs Annotated as FCC – FEDERAL COMMUNICATIONS COMMISSION Part 15 Compliant

##### Caution

This device complies with part 15 of the FCC Rules. Operation is subject to the following two conditions: (1) This device may not cause harmful interference, and (2) this device must accept any interference received, including interference that may cause undesired operation. Changes or modifications could void the user's authority to operate the equipment.

##### FCC Interference Statement for Class A EVM devices

This equipment has been tested and found to comply with the limits for a Class A digital device, pursuant to part 15 of the FCC Rules. These limits are designed to provide reasonable protection against harmful interference when the equipment is operated in a commercial environment. This equipment generates, uses, and can radiate radio frequency energy and, if not installed and used in accordance with the instruction manual, may cause harmful interference to radio communications. Operation of this equipment in a residential area is likely to cause harmful interference in which case the user will be required to correct the interference at its own expense.

##### FCC Interference Statement for Class B EVM devices

This equipment has been tested and found to comply with the limits for a Class B digital device, pursuant to part 15 of the FCC Rules. These limits are designed to provide reasonable protection against harmful interference in a residential installation. This equipment generates, uses and can radiate radio frequency energy and, if not installed and used in accordance with the instructions, may cause harmful interference to radio communications. However, there is no guarantee that interference will not occur in a particular installation. If this equipment does cause harmful interference to radio or television reception, which can be determined by turning the equipment off and on, the user is encouraged to try to correct the interference by one or more of the following measures:

- Reorient or relocate the receiving antenna.
- Increase the separation between the equipment and receiver.
- Connect the equipment into an outlet on a circuit different from that to which the receiver is connected.
- Consult the dealer or an experienced radio/TV technician for help.

##### Industry Canada Compliance (English)

#### For EVMs Annotated as IC – INDUSTRY CANADA Compliant:

This Class A or B digital apparatus complies with Canadian ICES-003.

Changes or modifications not expressly approved by the party responsible for compliance could void the user's authority to operate the equipment.

##### Concerning EVMs Including Radio Transmitters

This device complies with Industry Canada licence-exempt RSS standard(s). Operation is subject to the following two conditions: (1) this device may not cause interference, and (2) this device must accept any interference, including interference that may cause undesired operation of the device.

##### Concerning EVMs Including Detachable Antennas

Under Industry Canada regulations, this radio transmitter may only operate using an antenna of a type and maximum (or lesser) gain approved for the transmitter by Industry Canada. To reduce potential radio interference to other users, the antenna type and its gain should be so chosen that the equivalent isotropically radiated power (e.i.r.p.) is not more than that necessary for successful communication.

This radio transmitter has been approved by Industry Canada to operate with the antenna types listed in the user guide with the maximum permissible gain and required antenna impedance for each antenna type indicated. Antenna types not included in this list, having a gain greater than the maximum gain indicated for that type, are strictly prohibited for use with this device.

## Canada Industry Canada Compliance (French)

Cet appareil numérique de la classe A ou B est conforme à la norme NMB-003 du Canada

Les changements ou les modifications pas expressément approuvés par la partie responsable de la conformité ont pu vider l'autorité de l'utilisateur pour actionner l'équipement.

### Concernant les EVMs avec appareils radio

Le présent appareil est conforme aux CNR d'Industrie Canada applicables aux appareils radio exempts de licence. L'exploitation est autorisée aux deux conditions suivantes : (1) l'appareil ne doit pas produire de brouillage, et (2) l'utilisateur de l'appareil doit accepter tout brouillage radioélectrique subi, même si le brouillage est susceptible d'en compromettre le fonctionnement.

### Concernant les EVMs avec antennes détachables

Conformément à la réglementation d'Industrie Canada, le présent émetteur radio peut fonctionner avec une antenne d'un type et d'un gain maximal (ou inférieur) approuvé pour l'émetteur par Industrie Canada. Dans le but de réduire les risques de brouillage radioélectrique à l'intention des autres utilisateurs, il faut choisir le type d'antenne et son gain de sorte que la puissance isotrope rayonnée équivalente (p.i.r.e.) ne dépasse pas l'intensité nécessaire à l'établissement d'une communication satisfaisante.

Le présent émetteur radio a été approuvé par Industrie Canada pour fonctionner avec les types d'antenne énumérés dans le manuel d'usage et ayant un gain admissible maximal et l'impédance requise pour chaque type d'antenne. Les types d'antenne non inclus dans cette liste, ou dont le gain est supérieur au gain maximal indiqué, sont strictement interdits pour l'exploitation de l'émetteur.

Mailing Address: Texas Instruments, Post Office Box 655303, Dallas, Texas 75265  
Copyright © 2014, Texas Instruments Incorporated

## Important Notice for Users of EVMs Considered “Radio Frequency Products” in Japan

**EVMs entering Japan are NOT certified by TI as conforming to Technical Regulations of Radio Law of Japan.**

If user uses EVMs in Japan, user is required by Radio Law of Japan to follow the instructions below with respect to EVMs:

1. Use EVMs in a shielded room or any other test facility as defined in the notification #173 issued by Ministry of Internal Affairs and Communications on March 28, 2006, based on Sub-section 1.1 of Article 6 of the Ministry's Rule for Enforcement of Radio Law of Japan,
2. Use EVMs only after user obtains the license of Test Radio Station as provided in Radio Law of Japan with respect to EVMs, or
3. Use of EVMs only after user obtains the Technical Regulations Conformity Certification as provided in Radio Law of Japan with respect to EVMs. Also, do not transfer EVMs, unless user gives the same notice above to the transferee. Please note that if user does not follow the instructions above, user will be subject to penalties of Radio Law of Japan.

<http://www.tij.co.jp>

【無線電波を送信する製品の開発キットをお使いになる際の注意事項】本開発キットは技術基準適合証明を受けておりません。本製品のご使用に際しては、電波法遵守のため、以下のいずれかの措置を取っていただく必要がありますのでご注意ください。

1. 電波法施行規則第6条第1項第1号に基づく平成18年3月28日総務省告示第173号で定められた電波暗室等の試験設備でご使用いただく。
2. 実験局の免許を取得後ご使用いただく。
3. 技術基準適合証明を取得後ご使用いただく。。

なお、本製品は、上記の「ご使用にあたっての注意」を譲渡先、移転先に通知しない限り、譲渡、移転できないものとします

上記を遵守頂けない場合は、電波法の罰則が適用される可能性があることをご留意ください。

日本テキサス・インスツルメンツ株式会社

東京都新宿区西新宿6丁目24番1号

西新宿三井ビル

<http://www.tij.co.jp>

Texas Instruments Japan Limited

(address) 24-1, Nishi-Shinjuku 6 chome, Shinjuku-ku, Tokyo, Japan



## IMPORTANT NOTICE

Texas Instruments Incorporated and its subsidiaries (TI) reserve the right to make corrections, enhancements, improvements and other changes to its semiconductor products and services per JESD46, latest issue, and to discontinue any product or service per JESD48, latest issue. Buyers should obtain the latest relevant information before placing orders and should verify that such information is current and complete. All semiconductor products (also referred to herein as "components") are sold subject to TI's terms and conditions of sale supplied at the time of order acknowledgment.

TI warrants performance of its components to the specifications applicable at the time of sale, in accordance with the warranty in TI's terms and conditions of sale of semiconductor products. Testing and other quality control techniques are used to the extent TI deems necessary to support this warranty. Except where mandated by applicable law, testing of all parameters of each component is not necessarily performed.

TI assumes no liability for applications assistance or the design of Buyers' products. Buyers are responsible for their products and applications using TI components. To minimize the risks associated with Buyers' products and applications, Buyers should provide adequate design and operating safeguards.

TI does not warrant or represent that any license, either express or implied, is granted under any patent right, copyright, mask work right, or other intellectual property right relating to any combination, machine, or process in which TI components or services are used. Information published by TI regarding third-party products or services does not constitute a license to use such products or services or a warranty or endorsement thereof. Use of such information may require a license from a third party under the patents or other intellectual property of the third party, or a license from TI under the patents or other intellectual property of TI.

Reproduction of significant portions of TI information in TI data books or data sheets is permissible only if reproduction is without alteration and is accompanied by all associated warranties, conditions, limitations, and notices. TI is not responsible or liable for such altered documentation. Information of third parties may be subject to additional restrictions.

Resale of TI components or services with statements different from or beyond the parameters stated by TI for that component or service voids all express and any implied warranties for the associated TI component or service and is an unfair and deceptive business practice. TI is not responsible or liable for any such statements.

Buyer acknowledges and agrees that it is solely responsible for compliance with all legal, regulatory and safety-related requirements concerning its products, and any use of TI components in its applications, notwithstanding any applications-related information or support that may be provided by TI. Buyer represents and agrees that it has all the necessary expertise to create and implement safeguards which anticipate dangerous consequences of failures, monitor failures and their consequences, lessen the likelihood of failures that might cause harm and take appropriate remedial actions. Buyer will fully indemnify TI and its representatives against any damages arising out of the use of any TI components in safety-critical applications.

In some cases, TI components may be promoted specifically to facilitate safety-related applications. With such components, TI's goal is to help enable customers to design and create their own end-product solutions that meet applicable functional safety standards and requirements. Nonetheless, such components are subject to these terms.

No TI components are authorized for use in FDA Class III (or similar life-critical medical equipment) unless authorized officers of the parties have executed a special agreement specifically governing such use.

Only those TI components which TI has specifically designated as military grade or "enhanced plastic" are designed and intended for use in military/aerospace applications or environments. Buyer acknowledges and agrees that any military or aerospace use of TI components which have **not** been so designated is solely at the Buyer's risk, and that Buyer is solely responsible for compliance with all legal and regulatory requirements in connection with such use.

TI has specifically designated certain components as meeting ISO/TS16949 requirements, mainly for automotive use. In any case of use of non-designated products, TI will not be responsible for any failure to meet ISO/TS16949.

### Products

Audio	<a href="http://www.ti.com/audio">www.ti.com/audio</a>
Amplifiers	<a href="http://amplifier.ti.com">amplifier.ti.com</a>
Data Converters	<a href="http://dataconverter.ti.com">dataconverter.ti.com</a>
DLP® Products	<a href="http://www.dlp.com">www.dlp.com</a>
DSP	<a href="http://dsp.ti.com">dsp.ti.com</a>
Clocks and Timers	<a href="http://www.ti.com/clocks">www.ti.com/clocks</a>
Interface	<a href="http://interface.ti.com">interface.ti.com</a>
Logic	<a href="http://logic.ti.com">logic.ti.com</a>
Power Mgmt	<a href="http://power.ti.com">power.ti.com</a>
Microcontrollers	<a href="http://microcontroller.ti.com">microcontroller.ti.com</a>
RFID	<a href="http://www.ti-rfid.com">www.ti-rfid.com</a>
OMAP Applications Processors	<a href="http://www.ti.com/omap">www.ti.com/omap</a>
Wireless Connectivity	<a href="http://www.ti.com/wirelessconnectivity">www.ti.com/wirelessconnectivity</a>

### Applications

Automotive and Transportation	<a href="http://www.ti.com/automotive">www.ti.com/automotive</a>
Communications and Telecom	<a href="http://www.ti.com/communications">www.ti.com/communications</a>
Computers and Peripherals	<a href="http://www.ti.com/computers">www.ti.com/computers</a>
Consumer Electronics	<a href="http://www.ti.com/consumer-apps">www.ti.com/consumer-apps</a>
Energy and Lighting	<a href="http://www.ti.com/energy">www.ti.com/energy</a>
Industrial	<a href="http://www.ti.com/industrial">www.ti.com/industrial</a>
Medical	<a href="http://www.ti.com/medical">www.ti.com/medical</a>
Security	<a href="http://www.ti.com/security">www.ti.com/security</a>
Space, Avionics and Defense	<a href="http://www.ti.com/space-avionics-defense">www.ti.com/space-avionics-defense</a>
Video and Imaging	<a href="http://www.ti.com/video">www.ti.com/video</a>

### TI E2E Community

[e2e.ti.com](http://e2e.ti.com)

# Mouser Electronics

Authorized Distributor

Click to View Pricing, Inventory, Delivery & Lifecycle Information:

[Texas Instruments:](#)

[TPS23753AEVM-001](#)