

LM6132 Dual and LM6134 Quad, Low Power 10 MHz Rail-to-Rail I/O Operational Amplifiers

General Description

The LM6132/34 provides new levels of speed vs power performance in applications where low voltage supplies or power limitations previously made compromise necessary. With only 360 μA /amp supply current, the 10 MHz gain-bandwidth of this device supports new portable applications where higher power devices unacceptably drain battery life.

The LM6132/34 can be driven by voltages that exceed both power supply rails, thus eliminating concerns over exceeding the common-mode voltage range. The rail-to-rail output swing capability provides the maximum possible dynamic range at the output. This is particularly important when operating on low supply voltages. The LM6132/34 can also drive large capacitive loads without oscillating.

Operating on supplies from 2.7V to over 24V, the LM6132/34 is excellent for a very wide range of applications, from battery operated systems with large bandwidth requirements to high speed instrumentation.

Features (For 5V Supply, Typ Unless Noted)

- > Rail-to-Rail input CMVR -0.25V to 5.25V
- Rail-to-Rail output swing 0.01V to 4.99V
- High gain-bandwidth, 10 MHz at 20 kHz
- Slew rate $12\text{ V}/\mu\text{s}$
- Low supply current $360\ \mu\text{A}/\text{Amp}$
- Wide supply range 2.7V to over 24V
- CMRR 100 dB
- Gain 100 dB with $R_L = 10\text{k}$
- PSRR 82 dB

Applications

- Battery operated instrumentation
- Instrumentation Amplifiers
- Portable scanners
- Wireless communications
- Flat panel display driver

Connection Diagrams

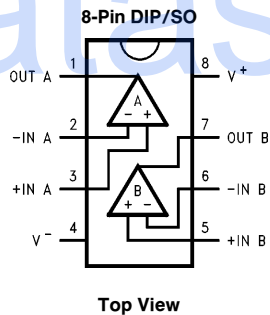

TL/H/12349-1

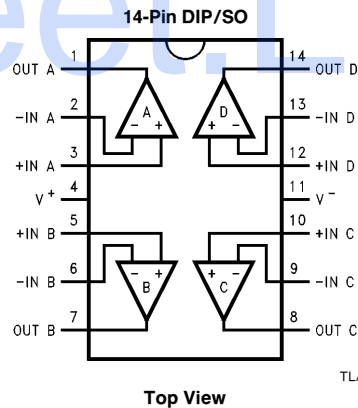

TL/H/12349-2

Ordering Information

Package	Temperature Range Industrial, -40°C to $+85^{\circ}\text{C}$	NSC Drawing	Transport Media
8-Pin Molded DIP	LM6132AIN, LM6132BIN	N08E	Rails
8-Pin Small Outline	LM6132AIM, LM6132BIM	M08A	Rails
	LM6132AIMX, LM6132BIMX	M08A	Tape and Reel
14-Pin Molded DIP	LM6134AIN, LM6134BIN	N14A	Rails
14-Pin Small Outline	LM6134AIM, LM6134BIM	M14A	Rails
	LM6134AIMX, LM6134BIMX	M14A	Tape and Reel

Absolute Maximum Ratings (Note 1)

If Military/Aerospace specified devices are required, please contact the National Semiconductor Sales Office/Distributors for availability and specifications.

ESD Tolerance (Note 2)	2500V
Differential Input Voltage	15V
Voltage at Input/Output Pin	(V ⁺) + 0.3V, (V ⁻) - 0.3V
Supply Voltage (V ⁺ - V ⁻)	35V
Current at Input Pin	± 10 mA
Current at Output Pin (Note 3)	± 25 mA
Current at Power Supply Pin	50 mA
Lead Temp. (soldering, 10 sec.)	260°C
Storage Temperature Range	-65°C to +150°C
Junction Temperature (Note 4)	150°C

Operating Ratings (Note 1)

Supply Voltage	1.8V ≤ V _S ≤ 24V
Junction Temperature Range	-40°C ≤ T _J ≤ +85°C
LM6132, LM6134	
Thermal resistance (θ _{JA})	
N Package, 8-pin Molded DIP	115°C/W
M Package, 8-pin Surface Mount	193°C/W
N Package, 14-pin Molded DIP	81°C/W
M Package, 14-pin Surface Mount	126°C/W

5.0V DC Electrical Characteristics Unless otherwise specified, all limits guaranteed for T_J = 25°C, V⁺ = 5.0V, V⁻ = 0V, V_{CM} = V_O = V⁺/2 and R_L > 1 MΩ to V_S/2. **Boldface** limits apply at the temperature extremes

Symbol	Parameter	Conditions	Typ (Note 5)	LM6134AI LM6132AI Limit (Note 6)	LM6134BI LM6132BI Limit (Note 6)	Units
V _{OS}	Input Offset Voltage		0.25	2 4	6 8	mV max
TCV _{OS}	Input Offset Voltage Average Drift		5			μV/C
I _B	Input Bias Current	0V ≤ V _{CM} ≤ 5V	110	140 300	180 350	nA max
I _{OS}	Input Offset Current		3.4	30 50	30 50	nA max
R _{IN}	Input Resistance, CM		104			MΩ
CMRR	Common Mode Rejection Ratio	0V ≤ V _{CM} ≤ 4V	100	75 70	75 70	dB min
		0V ≤ V _{CM} ≤ 5V	80	60 55	60 55	
PSRR	Power Supply Rejection Ratio	±2.5V ≤ V _S ≤ ±12V	82	78 75	78 75	
V _{CM}	Input Common-Mode Voltage Range		-0.25	0	0	V
			5.25	5.0	5.0	
A _V	Large Signal Voltage Gain	R _L = 10k	100	25 8	15 6	V/mV min

5.0V DC Electrical Characteristics Unless otherwise specified, all limits guaranteed for $T_J = 25^\circ\text{C}$, $V^+ = 5.0\text{V}$, $V^- = 0\text{V}$, $V_{CM} = V_O = V^+/2$ and $R_L > 1\text{M}\Omega$ to $V_S/2$. **Boldface** limits apply at the temperature extremes (Continued)

Symbol	Parameter	Conditions	Typ (Note 5)	LM6134AI LM6132AI Limit (Note 6)	LM6134BI LM6132BI Limit (Note 6)	Units
V_O	Output Swing	100k Load	4.992	4.98 4.93	4.98 4.93	V min
			0.007	0.017 0.019	0.017 0.019	V max
		10k Load	4.952	4.94 4.85	4.94 4.85	V min
			0.032	0.07 0.09	0.07 0.09	V max
		5k Load	4.923	4.90 4.85	4.90 4.85	V min
			0.051	0.095 0.12	0.095 0.12	V max
I_{SC}	Output Short Circuit Current	Sourcing	4.3	2	2	mA min
		Sinking	4.6	1.8	1.8	mA min
I_S	Supply Current	Per Amplifier	360	400 450	400 450	μA max

5.0V AC Electrical Characteristics Unless otherwise specified, all limits guaranteed for $T_J = 25^\circ\text{C}$, $V^+ = 5.0\text{V}$, $V^- = 0\text{V}$, $V_{CM} = V_O = V^+/2$ and $R_L > 1\text{M}\Omega$ to $V_S/2$. **Boldface** limits apply at the temperature extremes

Symbol	Parameter	Conditions	Typ (Note 5)	LM6134AI LM6132AI Limit (Note 6)	LM6134BI LM6132BI Limit (Note 6)	Units
SR	Slew Rate	$\pm 4\text{V} @ V_S = \pm 6\text{V}$ $R_S < 1\text{k}\Omega$	14	8 7	8 7	V/ μs min
GBW	Gain-Bandwidth Product	$f = 20\text{kHz}$	10	7.4 7	7.4 7	MHz min
θ_m	Phase Margin	$R_L = 10\text{k}$	33			deg
G_m	Gain Margin	$R_L = 10\text{k}$	10			dB
e_n	Input Referred Voltage Noise	$f = 1\text{kHz}$	27			$\frac{\text{nV}}{\sqrt{\text{Hz}}}$
i_n	Input Referred Current Noise	$f = 1\text{kHz}$	0.18			$\frac{\text{pA}}{\sqrt{\text{Hz}}}$

2.7V DC Electrical Characteristics Unless otherwise specified, all limits guaranteed for $T_J = 25^\circ\text{C}$, $V^+ = 2.7\text{V}$, $V^- = 0\text{V}$, $V_{\text{CM}} = V_O = V^+/2$ and $R_L > 1\text{M}\Omega$ to $V_S/2$. **Boldface** limits apply at the temperature extreme

Symbol	Parameter	Conditions	Typ (Note 5)	LM6134AI LM6132AI Limit (Note 6)	LM6134BI LM6132BI Limit (Note 6)	Units
V_{OS}	Input Offset Voltage		0.12	2 8	6 12	mV max
I_B	Input Bias Current	$0\text{V} \leq V_{\text{CM}} \leq 2.7\text{V}$	90			nA
I_{OS}	Input Offset Current		2.8			nA
R_{IN}	Input Resistance		134			$\text{M}\Omega$
CMRR	Common Mode Rejection Ratio	$0\text{V} \leq V_{\text{CM}} \leq 2.7\text{V}$	82			dB
PSRR	Power Supply Rejection Ratio	$\pm 1.35\text{V} \leq V_S \leq \pm 12\text{V}$	80			dB
V_{CM}	Input Common-Mode Voltage Range			2.7 0	2.7 0	V
A_v	Large Signal Voltage Gain	$R_L = 10\text{k}$	100			V/mV
V_O	Output Swing	$R_L = 10\text{k}$	0.03 2.66	0.08 0.112 2.65 2.25	0.08 0.112 2.65 2.25	V max V min
I_S	Supply Current	Per Amplifier	330			μA

2.7V AC Electrical Characteristics Unless otherwise specified, all limits guaranteed for $T_J = 25^\circ\text{C}$, $V^+ = 2.7\text{V}$, $V^- = 0\text{V}$, $V_{\text{CM}} = V_O = V^+/2$ and $R_L > 1\text{M}\Omega$ to $V_S/2$.

Symbol	Parameter	Conditions	Typ (Note 5)	LM6134AI LM6132AI Limit (Note 6)	LM6134BI LM6132BI Limit (Note 6)	Units
GBW	Gain-Bandwidth Product	$R_L = 10\text{k}$, $f = 20\text{kHz}$	7			MHz
θ_m	Phase Margin	$R_L = 10\text{k}$	23			deg
G_m	Gain Margin		12			dB

24V DC Electrical Characteristics Unless otherwise specified, all limits guaranteed for $T_J = 25^\circ\text{C}$, $V^+ = 24\text{V}$, $V^- = 0\text{V}$, $V_{\text{CM}} = V_O = V^+ / 2$ and $R_L > 1\text{ M}\Omega$ to $V_S/2$. **Boldface** limits apply at the temperature extreme

Symbol	Parameter	Conditions	Typ (Note 5)	LM6134AI LM6132AI Limit (Note 6)	LM6134BI LM6132BI Limit (Note 6)	Units
V_{OS}	Input Offset Voltage		1.7	3 5	7 9	mV max
I_B	Input Bias Current	$0\text{V} \leq V_{\text{CM}} \leq 24\text{V}$	125			nA
I_{OS}	Input Offset Current		4.8			nA
R_{IN}	Input Resistance		210			$\text{M}\Omega$
CMRR	Common Mode Rejection Ratio	$0\text{V} \leq V_{\text{CM}} \leq 24\text{V}$	80			dB
PSRR	Power Supply Rejection Ratio	$2.7\text{V} \leq V_S \leq 24\text{V}$	82			dB
V_{CM}	Input Common-Mode Voltage Range		-0.25	0	0	V min
			24.25	24	24	V max
A_V	Large Signal Voltage Gain	$R_L = 10\text{k}$	102			V/mV
V_O	Output Swing	$R_L = 10\text{k}$	0.075	0.15	0.15	V max
			23.86	23.8	23.8	V min
I_S	Supply Current	Per Amplifier	390	450 490	450 490	μA max

24V AC Electrical Characteristics Unless otherwise specified, all limits guaranteed for $T_J = 25^\circ\text{C}$, $V^+ = 24\text{V}$, $V^- = 0\text{V}$, $V_{\text{CM}} = V_O = V^+ / 2$ and $R_L > 1\text{ M}\Omega$ to $V_S/2$.

Symbol	Parameter	Conditions	Typ (Note 5)	LM6134AI LM6132AI Limit (Note 6)	LM6134BI LM6132BI Limit (Note 6)	Units
GBW	Gain-Bandwidth Product	$R_L = 10\text{k}$, $f = 20\text{ kHz}$	11			MHz
θ_m	Phase Margin	$R_L = 10\text{k}$	23			deg
G_m	Gain Margin	$R_L = 10\text{k}$	12			dB
THD + N	Total Harmonic Distortion and Noise	$A_V = +1$, $V_O = 20\text{V}_{\text{P-P}}$ $f = 10\text{ kHz}$	0.0015			%

Note 1: Absolute Maximum Ratings indicate limits beyond which damage to the device may occur. Operating Ratings indicate conditions for which the device is intended to be functional, but specific performance is not guaranteed. For guaranteed specifications and the test conditions, see the Electrical characteristics.

Note 2: Human body model, 1.5 k Ω in series with 100 pF.

Note 3: Applies to both single-supply and split-supply operation. Continuous short circuit operation at elevated ambient temperature can result in exceeding the maximum allowed junction temperature of 150°C.

Note 4: The maximum power dissipation is a function of $T_{\text{J(max)}}$, θ_{JA} , and T_A . The maximum allowable power dissipation at any ambient temperature is $P_D = (T_{\text{J(max)}} - T_A) / \theta_{\text{JA}}$. All numbers apply for packages soldered directly into a PC board.

Note 5: Typical Values represent the most likely parametric norm.

Note 6: All limits are guaranteed by testing or statistical analysis.

Typical Performance Characteristics $T_A = 25^\circ\text{C}$, $R_L = 10\text{ k}\Omega$ unless otherwise specified

Supply Current vs Supply Voltage

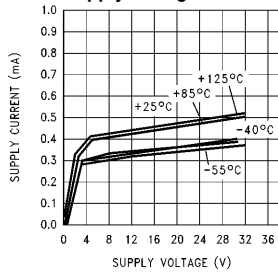

TL/H/12349-3

Offset Voltage vs Supply Voltage

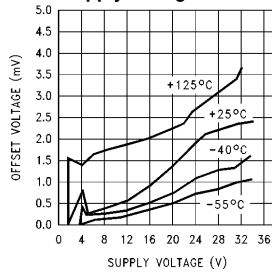

TL/H/12349-5

dVos vs VCM

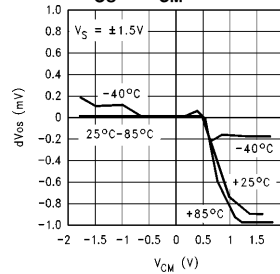

TL/H/12349-6

dVos vs VCM

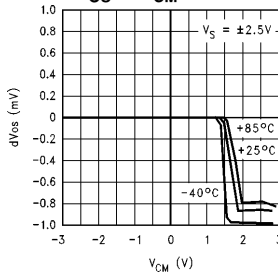

TL/H/12349-7

dVos vs VCM

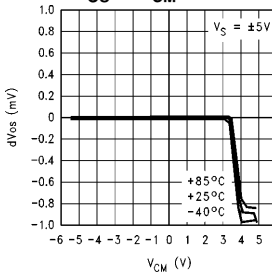

TL/H/12349-8

Ibias vs VCM

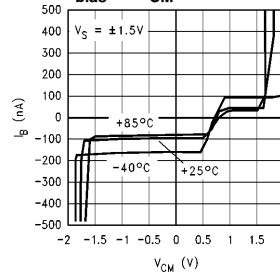

TL/H/12349-9

Ibias vs VCM

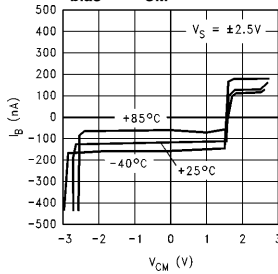

TL/H/12349-10

Ibias vs VCM

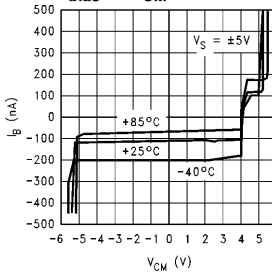

TL/H/12349-11

Input Bias Current vs Supply Voltage

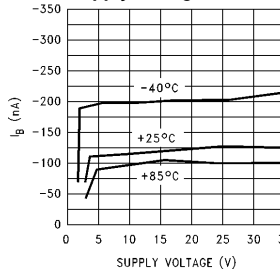

TL/H/12349-12

Neg PSRR vs Frequency

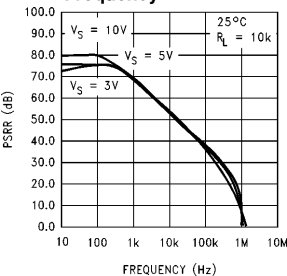

TL/H/12349-13

Pos PSRR vs Frequency

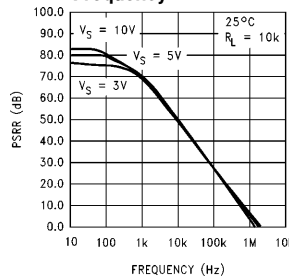

TL/H/12349-14

Typical Performance Characteristics $T_A = 25^\circ\text{C}$, $R_L = 10\text{ k}\Omega$ unless otherwise specified (Continued)

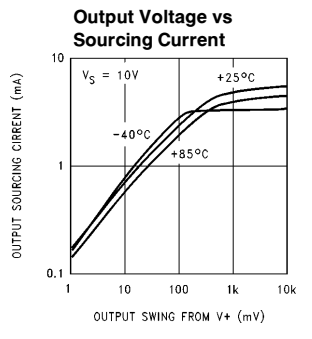
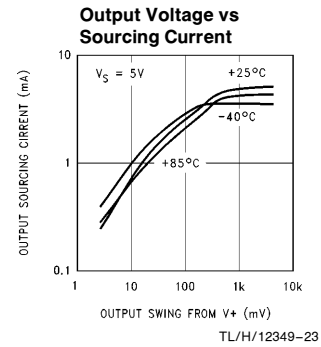
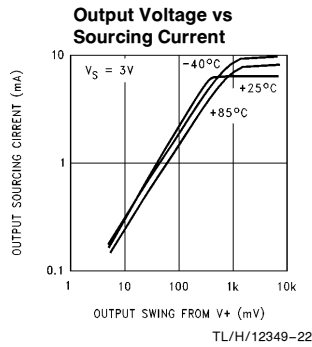
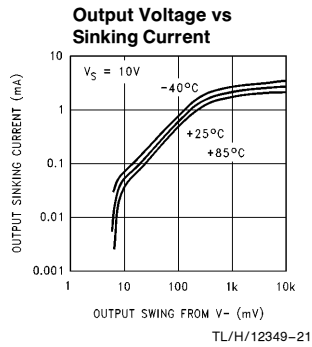
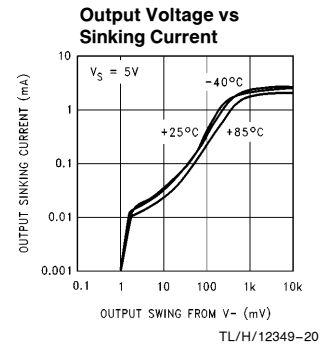
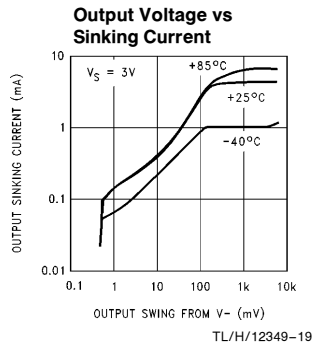
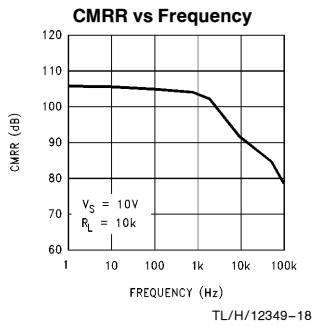
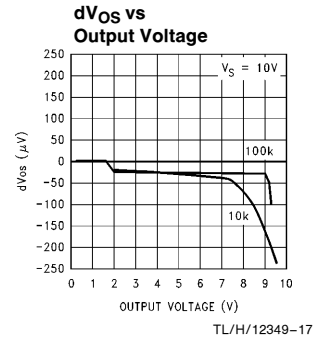
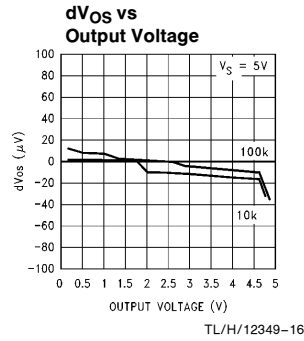
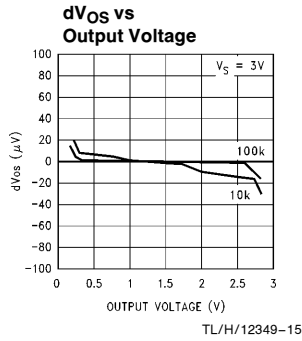

Typical Performance Characteristics $T_A = 25^\circ\text{C}$, $R_L = 10\text{ k}\Omega$ unless otherwise specified (Continued)

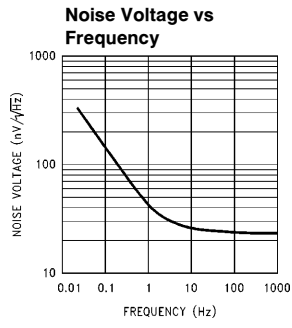

TL/H/12349-25

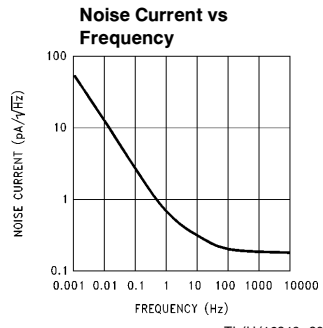

TL/H/12349-38

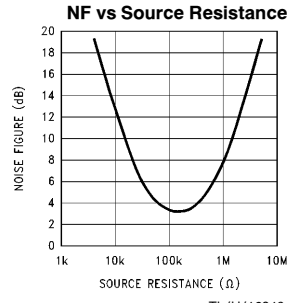

TL/H/12349-39

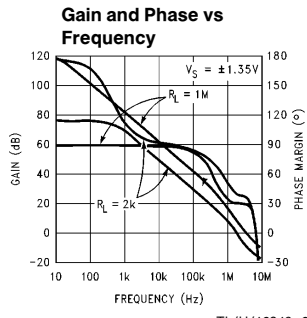

TL/H/12349-28

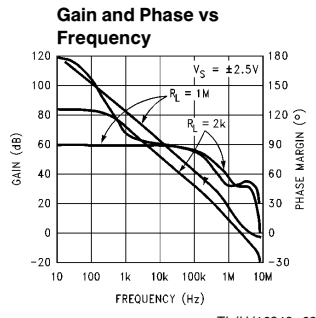

TL/H/12349-29

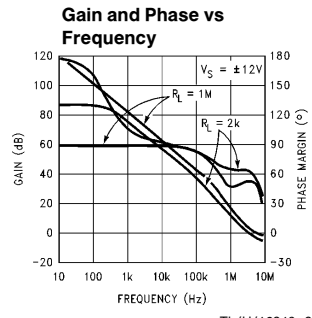

TL/H/12349-30

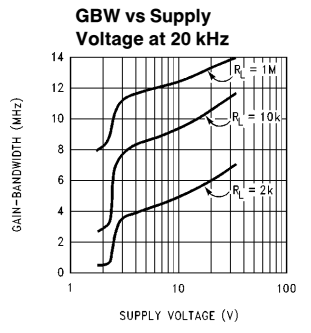

TL/H/12349-31

LM6132/34 Application Hints

The LM6132 brings a new level of ease of use to opamp system design.

With greater than rail-to-rail input voltage range concern over exceeding the common-mode voltage range is eliminated.

Rail-to-rail output swing provides the maximum possible dynamic range at the output. This is particularly important when operating on low supply voltages.

The high gain-bandwidth with low supply current opens new battery powered applications, where high power consumption, previously reduced battery life to unacceptable levels.

To take advantage of these features, some ideas should be kept in mind.

ENHANCED SLEW RATE

Unlike most bipolar opamps, the unique phase reversal prevention/speed-up circuit in the input stage eliminates phase reversal and allows the slew rate to be very much a function of the input signal amplitude.

Figure 1 shows how excess input signal is routed around the input collector-base junctions directly to the current mirrors. The LM6132/34 input stage converts the input voltage change to a current change. This current change drives the current mirrors through the collectors of Q1–Q2, Q3–Q4 when the input levels are normal.

If the input signal exceeds the slew rate of the input stage and the differential input voltage rises above a diode drop, the excess signal bypasses the normal input transistors, (Q1–Q4), and is routed in correct phase through the two additional transistors, (Q5, Q6), directly into the current mirrors.

This rerouting of excess signal allows the slew-rate to increase by a factor of 10 to 1 or more. (See Figure 2.)

As the overdrive increases, the opamp reacts better than a conventional opamp. Large fast pulses will raise the slew-rate to around 25V to 30V/ μ s.

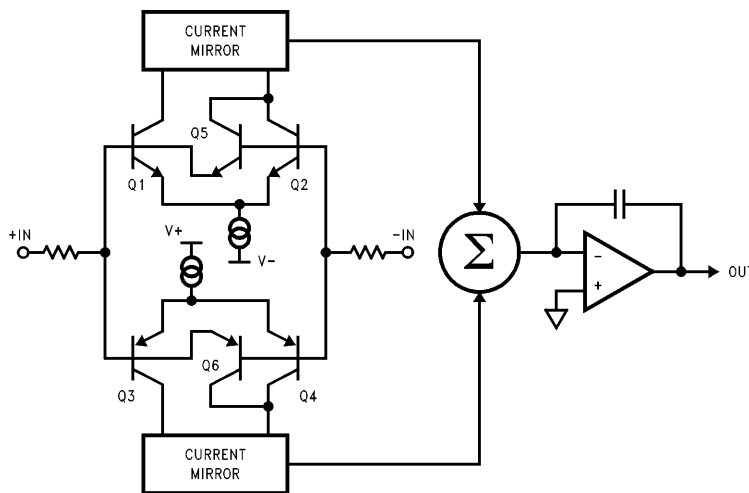

FIGURE 1

TL/H/12349-36

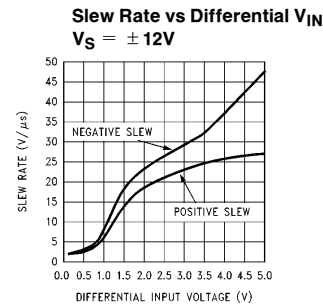

FIGURE 2

TL/H/12349-40

This effect is most noticeable at higher supply voltages and lower gains where incoming signals are likely to be large.

This speed-up action adds stability to the system when driving large capacitive loads.

DRIVING CAPACITIVE LOADS

Capacitive loads decrease the phase margin of all opamps. This is caused by the output resistance of the amplifier and the load capacitance forming an R-C phase lag network. This can lead to overshoot, ringing and oscillation. Slew rate limiting can also cause additional lag. Most opamps with a fixed maximum slew-rate will lag further and further behind when driving capacitive loads even though the differential input voltage raises. With the LM6132, the lag causes the slew rate to raise. The increased slew-rate keeps the output following the input much better. This effectively reduces phase lag. After the output has caught up with the input, the differential input voltage drops down and the amplifier settles rapidly.

LM6132/34 Application Hints

(Continued)

These features allow the LM6132 to drive capacitive loads as large as 500 pF at unity gain and not oscillate. The scope photos (Figure 3 and 4) above show the LM6132 driving a 500 pF load. In Figure 3, the lower trace is with no capacitive load and the upper trace is with a 500 pF load. Here we are operating on $\pm 12V$ supplies with a 20 Vp-p pulse. Excellent response is obtained with a C_f of 39 pF. In Figure 4, the supplies have been reduced to $\pm 2.5V$, the pulse is 4 Vp-p and C_f is 39 pF. The best value for the compensation capacitor should be established after the board layout is finished because the value is dependent on board stray capacity, the closed loop gain and, to some extent, the supply voltage.

Another effect that is common to all opamps is the phase shift caused by the feedback resistor and the input capacitance. This phase shift also reduces phase margin. This effect is taken care of at the same time as the effect of the capacitive load when the capacitor is placed across the feedback resistor.

The circuit shown in Figure 5 was used for these scope photos.

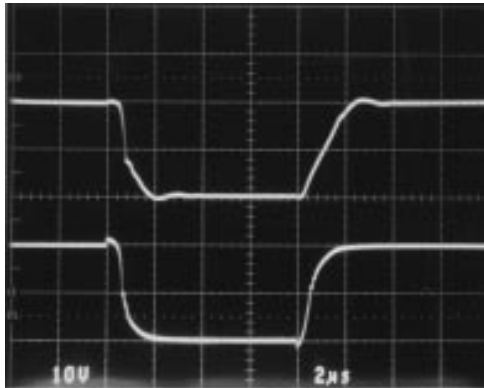

FIGURE 3

TL/H/12349-45

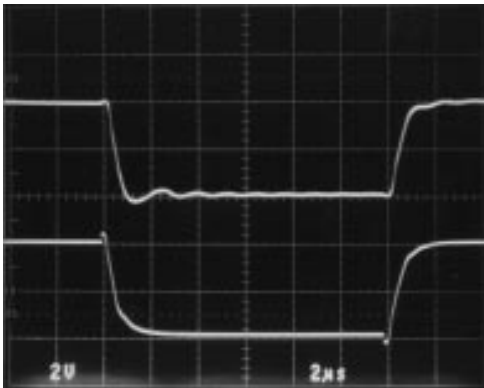
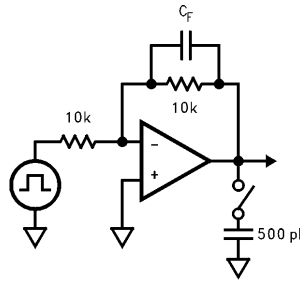

FIGURE 4

TL/H/12349-42



TL/H/12349-43

FIGURE 5

Figure 6 shows a method for compensating for load capacitance (C_o) effects by adding both an isolation resistor R_o at the output and a feedback capacitor C_f directly between the output and the inverting input pin. Feedback capacitor C_f compensates for the pole introduced by R_o and C_o , minimizing ringing in the output waveform while the feedback resistor R_f compensates for dc inaccuracies introduced by R_o . Depending on the size of the load capacitance, the value of R_o is typically chosen to be between 100 Ω to 1 k Ω .

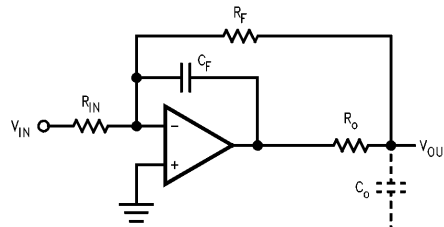

TL/H/12349-37

FIGURE 6

Typical Applications

3 OPAMP INSTRUMENTATION AMP WITH RAIL-TO-RAIL INPUT AND OUTPUT

Using the LM6134, a 3 opamp instrumentation amplifier with rail-to-rail inputs and rail to rail output can be made. These features make these instrumentation amplifiers ideal for single supply systems.

Some manufacturers use a precision voltage divider array of 5 resistors to divide the common-mode voltage to get an input range of rail-to-rail or greater. The problem with this method is that it also divides the signal, so to even get unity gain, the amplifier must be run at high closed loop gains. This raises the noise and drift by the internal gain factor and lowers the input impedance. Any mismatch in these precision resistors reduces the CMR as well. Using the LM6134, all of these problems are eliminated.

In this example, amplifiers A and B act as buffers to the differential stage (Figure 7). These buffers assure that the input impedance is over 100 M Ω and they eliminate the requirement for precision matched resistors in the input stage. They also assure that the difference amp is driven from a voltage source. This is necessary to maintain the CMR set by the matching of R1–R2 with R3–R4.

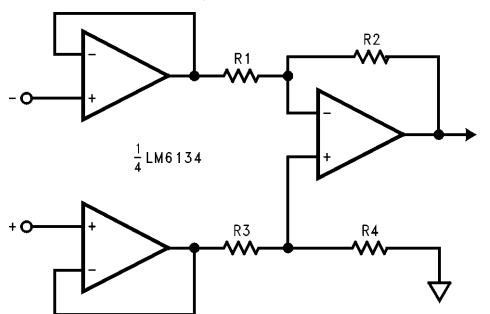

FIGURE 7

FLAT PANEL DISPLAY BUFFERING

Three features of the LM6132/34 make it a superb choice for TFT LCD applications. First, its low current draw (360 μ A per amplifier @ 5V) makes it an ideal choice for battery powered applications such as in laptop computers. Second, since the device operates down to 2.7V, it is a natural choice for next generation 3V TFT panels. Last, but not least, the large capacitive drive capability of the LM6132 comes in very handy in driving highly capacitive loads that are characteristic of LCD display drivers.

The large capacitive drive capability of the LM6132/34 allows it to be used as buffers for the gamma correction reference voltage inputs of resistor-DAC type column (Source) drivers in TFT LCD panels. This amplifier is also useful for buffering only the center reference voltage input of Capacitor-DAC type column (Source) drivers such as the LMC750X series.

Since for VGA and SVGA displays, the buffered voltages must settle within approximately 4 μ s, the well known technique of using a small isolation resistor in series with the amplifier's output very effectively dampens the ringing at the output.

With its wide supply voltage range of 2.7V to 24V, the LM6132/34 can be used for a diverse range of applications. The system designer is thus able to choose a single device type that serves many sub-circuits in the system, eliminating the need to specify multiple devices in the bill of materials. Along with its sister parts, the LM6142 and LM6152 that have the same wide supply voltage capability, choice of the LM6132 in a design eliminates the need to search for multiple sources for new designs.

Physical Dimensions inches (millimeters) unless otherwise noted

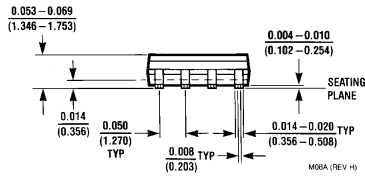
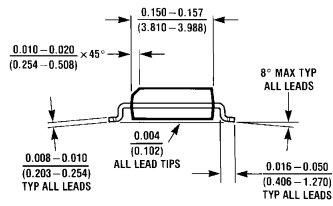
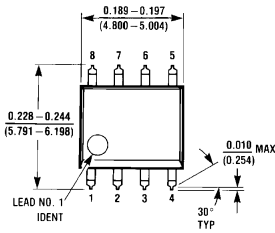

**8-Lead (0.150" Wide) Molded Small Outline Package, JEDEC
Order Number LM6132AIM, LM6132BIM, LM6132AIMX or LM6132BIMX
NS Package Number M08A**

Physical Dimensions inches (millimeters) unless otherwise noted (Continued)

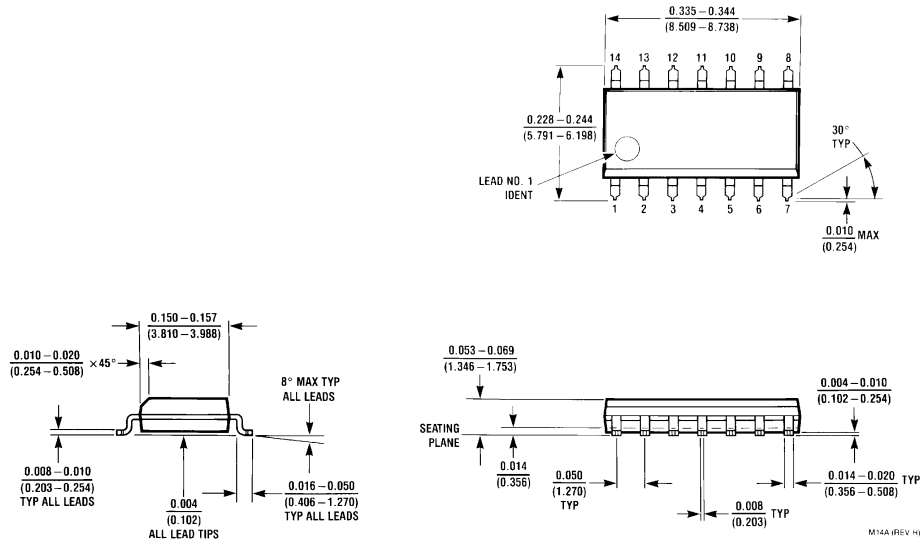

14-Lead (0.300" Wide) Molded Small Outline Package, JEDEC
Order Number LM6134AIM, LM6134BIM, LM6134AIMX or LM6134BIMX
NS Package Number M14A

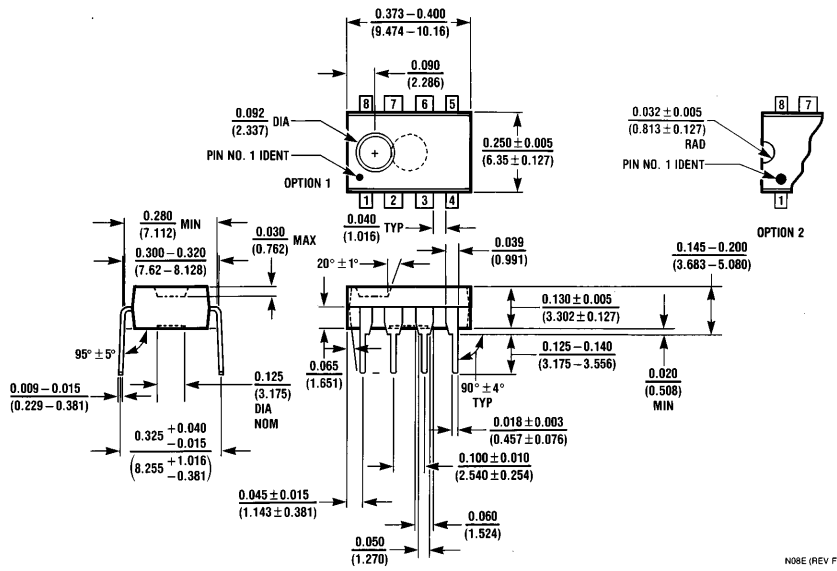

8-Lead (0.300" Wide) Molded Dual-In-Line Package
Order Number LM6132AIN, LM6132BIN
NS Package Number N08E

Physical Dimensions inches (millimeters) unless otherwise noted (Continued)

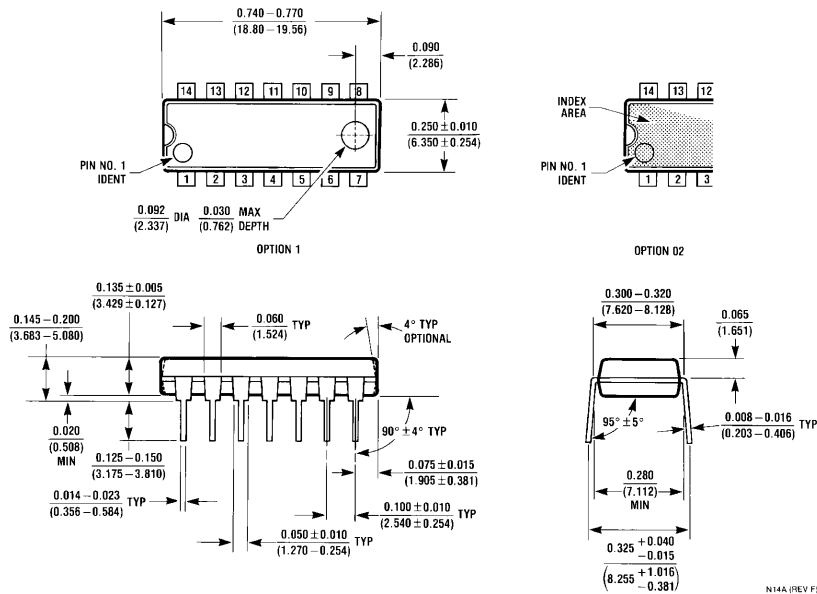

14-Lead (0.300" Wide) Molded Dual-In-Line Package
Order Number LM6134AIN, LM6134BIN
NS Package Number N14A

LIFE SUPPORT POLICY

NATIONAL'S PRODUCTS ARE NOT AUTHORIZED FOR USE AS CRITICAL COMPONENTS IN LIFE SUPPORT DEVICES OR SYSTEMS WITHOUT THE EXPRESS WRITTEN APPROVAL OF THE PRESIDENT OF NATIONAL SEMICONDUCTOR CORPORATION. As used herein:

- Life support devices or systems are devices or systems which, (a) are intended for surgical implant into the body, or (b) support or sustain life, and whose failure to perform, when properly used in accordance with instructions for use provided in the labeling, can be reasonably expected to result in a significant injury to the user.
- A critical component is any component of a life support device or system whose failure to perform can be reasonably expected to cause the failure of the life support device or system, or to affect its safety or effectiveness.

 <p>National Semiconductor Corporation 1111 West Bardin Road Arlington, TX 76017 Tel: 1(800) 272-9959 Fax: 1(800) 737-7018 http://www.national.com</p>	<p>National Semiconductor Europe Fax: +49 (0) 180-530 85 86 Email: europe.support@nsc.com Deutsch Tel: +49 (0) 180-530 85 85 English Tel: +49 (0) 180-532 78 32 Français Tel: +49 (0) 180-532 93 58 Italiano Tel: +49 (0) 180-534 16 80</p>	<p>National Semiconductor Hong Kong Ltd. 19th Floor, Straight Block, Ocean Centre, 5 Canton Rd. Tsimshatsui, Kowloon Hong Kong Tel: (852) 2737-1600 Fax: (852) 2736-9960</p>	<p>National Semiconductor Japan Ltd. Tel: 81-043-299-2308 Fax: 81-043-299-2408</p>
---	--	---	---

National does not assume any responsibility for use of any circuitry described, no circuit patent licenses are implied and National reserves the right at any time without notice to change said circuitry and specifications.