



HARRIS

4302271 0053993 72T HAS

IRF530/531/532/533 IRF530R/531R/532R/533R

N-Channel Power MOSFETs Avalanche Energy Rated*

May 1992

Features

- 12A and 14A, 80V - 100V
- $r_{DS(on)} = 0.16\Omega$ and 0.23Ω
- Single Pulse Avalanche Energy Rated*
- SOA is Power-Dissipation Limited
- Nanosecond Switching Speeds
- Linear Transfer Characteristics
- High Input Impedance

Description

The IRF530, IRF531, IRF532, and IRF533 are n-channel enhancement-mode silicon-gate power field-effect transistors. IRF530R, IRF531R, IRF532R and IRF533R types are advanced power MOSFETs designed, tested, and guaranteed to withstand a specified level of energy in the breakdown avalanche mode of operation. All of these power MOSFETs are designed for applications such as switching regulators, switching converters, motor drivers, relay drivers, and drivers for high-power bipolar switching transistors requiring high speed and low gate-drive power. These types can be operated directly from integrated circuits.

The IRF types are supplied in the JEDEC TO-220AB plastic package.

Package

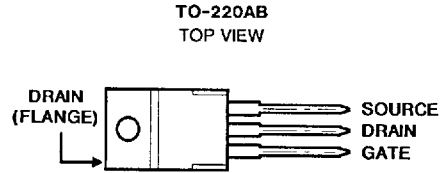

Terminal Diagram

N-CHANNEL ENHANCEMENT MODE

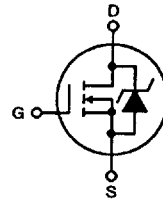

Absolute Maximum Ratings ($T_C = +25^\circ\text{C}$), Unless Otherwise Specified

	IRF530 IRF530R	IRF531 IRF531R	IRF532 IRF532R	IRF533 IRF533R	UNITS
Drain-Source Voltage (1)	V_{DS} 100	80	100	80	V
Drain-Gate Voltage ($R_{GS} = 20k\Omega$) (1)	V_{DGR} 100	80	100	80	V
Continuous Drain Current					
$T_C = +25^\circ\text{C}$	I_D 14	14	12	12	A
$T_C = +100^\circ\text{C}$	I_D 10	10	8.3	8.3	A
Pulsed Drain Current (3)	I_{DM} 56	56	48	48	A
Gate-Source Voltage	V_{GS} ± 20	± 20	± 20	± 20	V
Maximum Power Dissipation					
$T_C = +25^\circ\text{C}$	P_D 79	79	79	79	W
Linear Derating Factor	0.53	0.53	0.53	0.53	W/ $^\circ\text{C}$
Inductive Current, Clamped	I_{LM} 56	56	48	48	A
(See Figure 14, $L = 100\mu\text{H}$)					
Single Pulse Avalanche Energy Rating (4)	E_{AS}^* 69	69	69	69	mJ
Operating and Storage Junction	T_J, T_{STG} -55 to +175	-55 to +175	-55 to +175	-55 to +175	$^\circ\text{C}$
Temperature Range					
Maximum Lead Temperature for Soldering	T_L 300	300	300	300	$^\circ\text{C}$
(0.063" (1.6mm) from case for 10s)					

NOTES:

- $T_J = +25^\circ\text{C}$ to $+150^\circ\text{C}$.
 - Pulse Test: Pulse width $\leq 300\mu\text{s}$, Duty Cycle $\leq 2\%$.
 - Repetitive rating: Pulse width limited by maximum junction temperature. See Transient Thermal Impedance Curve (Figure 5).
 - $V_{DD} = 25\text{V}$, starting $T_J = +25^\circ\text{C}$, $L = 530\mu\text{H}$, $R_{GS} = 25\Omega$, $I_{PEAK} = 14\text{A}$. See Figure 15.
- *R Suffix Types Only

Electrical Characteristics $T_C = 25^\circ\text{C}$, Unless Otherwise Specified

CHARACTERISTIC	SYMBOL	TEST CONDITIONS	LIMITS			UNITS	
			MIN	TYP	MAX		
Drain-Source Breakdown Voltage IRF530/532, IRF530R/532R	BV _{DSS}	$V_{GS} = 0V, I_D = 250\mu A$	100	-	-	V	
IRF531/533, IRF531R/533R			80	-	-	V	
Gate Threshold Voltage	V _{GS(TH)}	$V_{DS} = V_{GS}, I_D = 250\mu A$	2.0	-	4.0	V	
Gate-Source Leakage Forward	I _{GSS}	$V_{GS} = 20V$	-	-	500	nA	
Gate-Source Leakage Reverse	I _{GSS}	$V_{GS} = -20V$	-	-	-500	nA	
Zero Gate Voltage Drain Current	I _{DSS}	$V_{DS} = \text{Max Rating}, V_{GS} = 0V$	-	-	250	μA	
		$V_{DS} = \text{Max Rating} \times 0.8, V_{GS} = 0V, T_J = +125^\circ\text{C}$	-	-	1000	μA	
On-State Drain Current (Note 2) IRF530/531, IRF530R/531R	I _{D(ON)}	$V_{DS} > I_{D(ON)} \times r_{DS(ON)} \text{ Max}, V_{GS} = 10V$	14	-	-	A	
			IRF532/533, IRF532R/533R	12	-	-	A
Static Drain-Source On-State Resistance (Note 2) IRF530/531, IRF530R/531R	r _{DS(ON)}	$V_{GS} = 10V, I_D = 8.3A$	-	0.14	0.16	Ω	
			IRF532/533, IRF532R/533R	-	0.20	0.23	Ω
Forward Transconductance (Note 2)	g _{fs}	$V_{DS} \geq 50V, I_D = 8.3A$	5.1	7.6	-	S(\bar{S})	
Input Capacitance	C _{ISS}	$V_{GS} = 0V, V_{DS} = 25V, f = 1.0\text{MHz}$	-	600	-	pF	
Output Capacitance	C _{OSS}	See Figure 10	-	250	-	pF	
Reverse Transfer Capacitance	C _{RSS}		-	50	-	pF	
Turn-On Delay Time	t _{d(ON)}	$V_{DD} = 50V, I_D \approx 14A, R_G = 12\Omega$ See Figure 18. (MOSFET switching times are essentially independent of operating temperature)	-	12	15	ns	
Rise Time	t _r		-	35	51	ns	
Turn-Off Delay Time	t _{d(OFF)}		-	25	35	ns	
Fall Time	t _f		-	25	36	ns	
Total Gate Charge (Gate-Source + Gate-Drain)	Q _g	$V_{GS} = 10V, I_D = 14A, V_{DS} = 0.8V \text{ Max Rating}$. See Figure 17 for test circuit. (Gate charge is essentially independent of operating temperature.)	-	18	26	nC	
Gate-Source Charge	Q _{gs}		-	4	-	nC	
Gate-Drain ("Miller") Charge	Q _{gd}		-	7	-	nC	
Internal Drain Inductance	L _D	Measured from the contact screw on tab to center of die	Modified MOSFET symbol showing the internal device inductances.	-	3.5	-	nH
		Measured from the drain lead, 6mm (0.25in.) from package to center of die		-	4.5	-	nH
Internal Source Inductance	L _S	Measured from the source lead, 6mm (0.25") from header and source bonding pad.	-	7.5	-	nH	
Junction-to-Case	R _{θJC}		-	-	1.9	$^\circ\text{C/W}$	
Case-to-Sink	R _{θCS}	Mounting surface flat, smooth and greased	-	0.5	-	$^\circ\text{C/W}$	
Junction-to-Ambient	R _{θJA}	Free air operation	-	-	80	$^\circ\text{C/W}$	

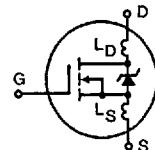

Source Drain Diode Ratings and Characteristics

Continuous Source Current (Body Diode)	I _S	Modified MOSFET symbol showing the integral reverse P-N junction rectifier.	-	-	14	A
Pulse Source Current (Body Diode) (Note 3)	I _{SM}		-	-	56	A
Diode Forward Voltage (Note 2)	V _{SD}	$T_J = +25^\circ\text{C}, I_S = 14A, V_{GS} = 0V$	-	-	2.5	V
Reverse Recovery Time	t _{rr}	$T_J = +25^\circ\text{C}, I_F = 14A, di_F/dt = 100A/\mu s$	5.5	120	250	ns
Reverse Recovered Charge	Q _{RR}	$T_J = +25^\circ\text{C}, I_F = 14A, di_F/dt = 100A/\mu s$	0.26	0.6	1.3	μC
Forward Turn-on Time	t _{ON}	Intrinsic turn-on time is negligible. Turn-on speed is substantially controlled by L _S + L _D .	-	-	-	-

NOTES: 1. $T_J = +25^\circ\text{C}$ to $+150^\circ\text{C}$

2. Pulse Test: Pulse width $\leq 300\mu s$, Duty Cycle $\leq 2\%$

3. Repetitive Rating: Pulse width limited by max. junction temperature. See Transient Thermal Impedance Curve (Figure 5)

4. $V_{DD} = 25V$, Start $T_J = +25^\circ\text{C}$, $L = 350\mu H$, $R_{GS} = 25\Omega$, $I_{PEAK} = 14A$ (See Figure 15)

4
N-CHANNEL
POWER MOSFETS

Performance Curves

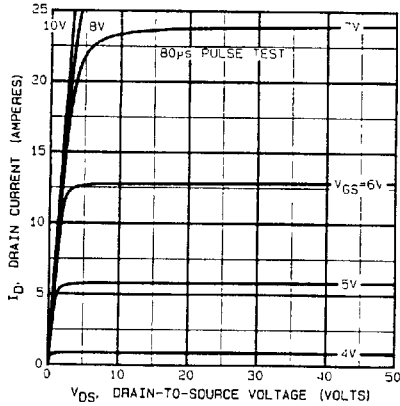

FIGURE 1. TYPICAL OUTPUT CHARACTERISTICS

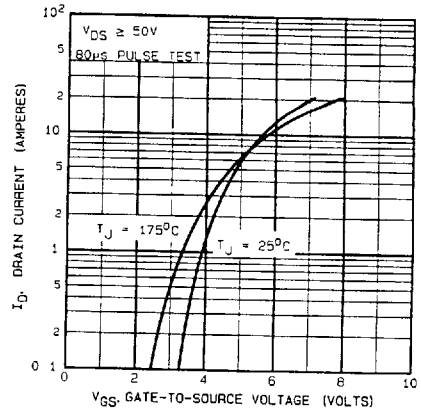

FIGURE 2. TYPICAL TRANSFER CHARACTERISTICS

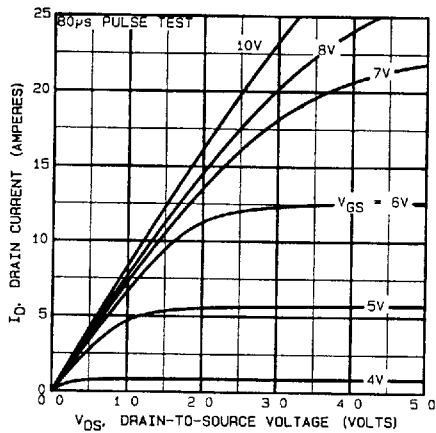

FIGURE 3. TYPICAL SATURATION CHARACTERISTICS

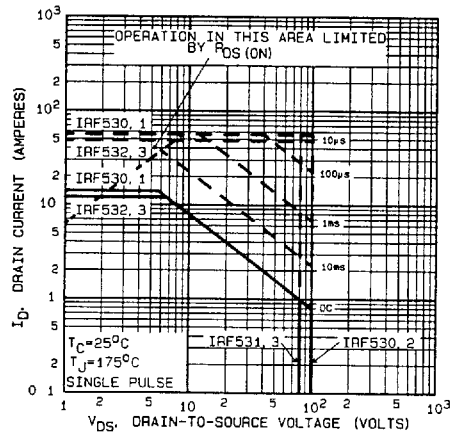

FIGURE 4. MAXIMUM SAFE OPERATING AREA

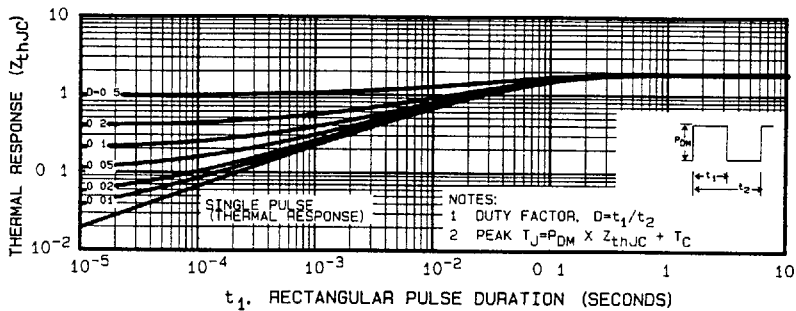

FIGURE 5. MAXIMUM EFFECTIVE TRANSIENT THERMAL IMPEDANCE, JUNCTION-TO-CASE vs PULSE DURATION

Performance Curves (Continued)

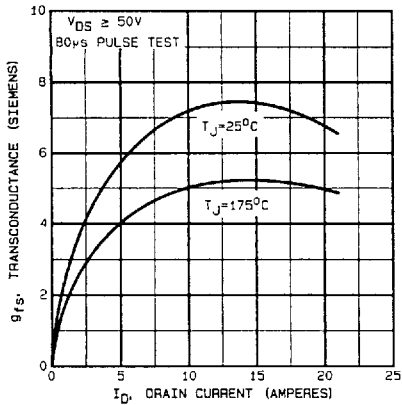

FIGURE 6. TRANSCONDUCTANCE vs DRAIN CURRENT

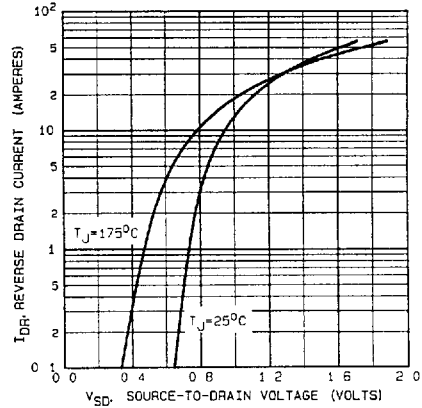

FIGURE 7. TYPICAL SOURCE-DRAIN DIODE FORWARD VOLTAGE

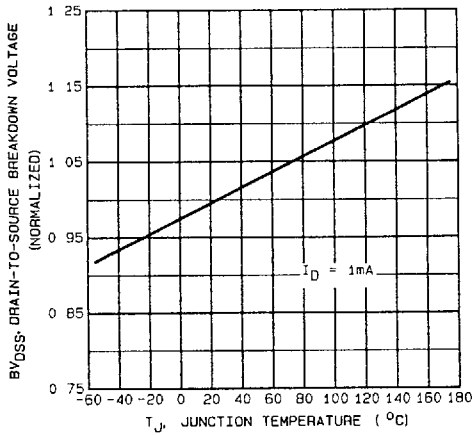

FIGURE 8. BREAKDOWN VOLTAGE vs TEMPERATURE

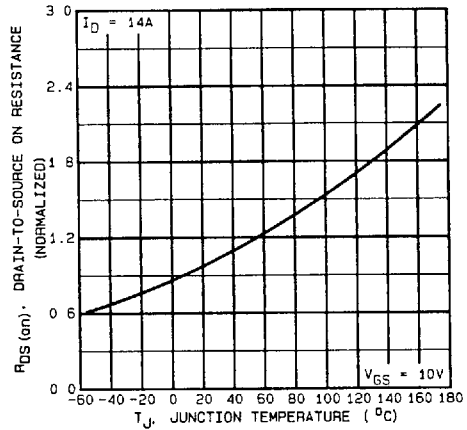

FIGURE 9. NORMALIZED ON-RESISTANCE vs TEMPERATURE

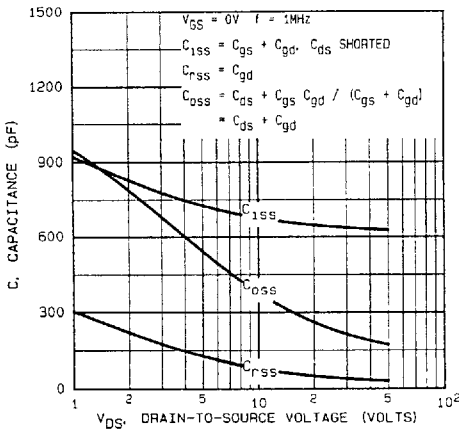

FIGURE 10. TYPICAL CAPACITANCE vs DRAIN-TO-SOURCE VOLTAGE

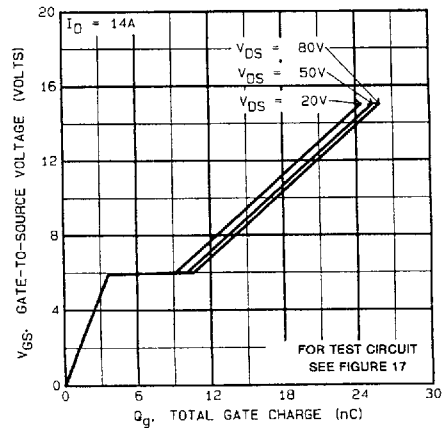

FIGURE 11. TYPICAL GATE CHARGE vs GATE-TO-SOURCE VOLTAGE

Performance Curves (Continued)

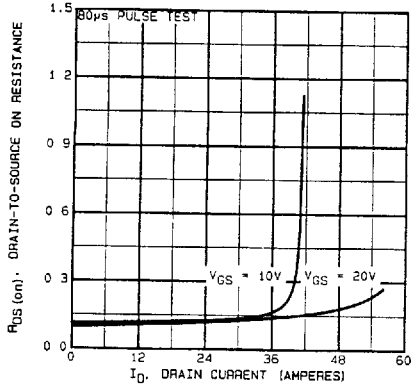

FIGURE 12. TYPICAL ON RESISTANCE vs DRAIN CURRENT

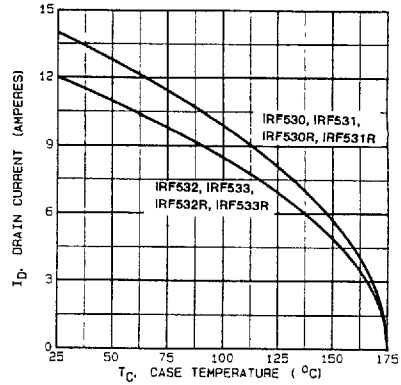

FIGURE 13. MAXIMUM DRAIN CURRENT vs CASE TEMPERATURE

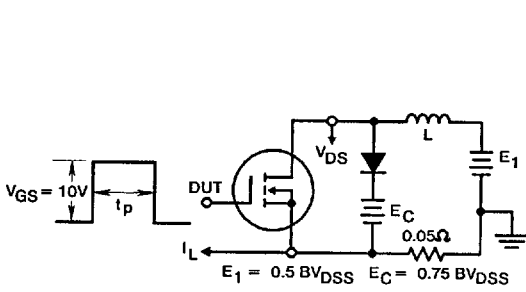

FIGURE 14a. CLAMPED INDUCTIVE TEST CIRCUIT

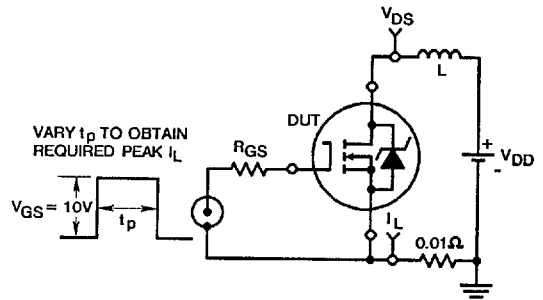

FIGURE 15a. UNCLAMPED ENERGY TEST CIRCUIT

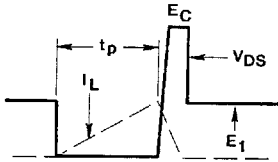

FIGURE 14b. CLAMPED INDUCTIVE WAVEFORMS

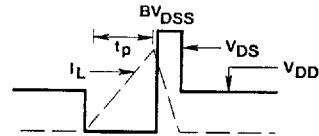

FIGURE 15b. UNCLAMPED ENERGY WAVEFORMS

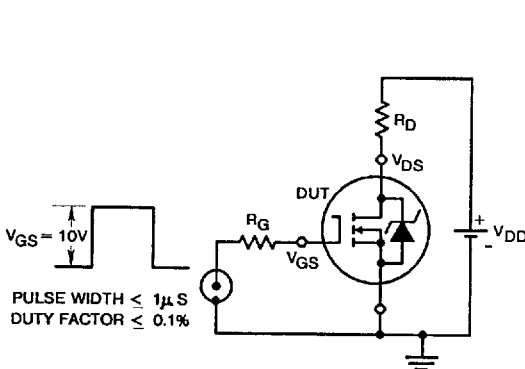

FIGURE 16. SWITCHING TIME TEST CIRCUIT

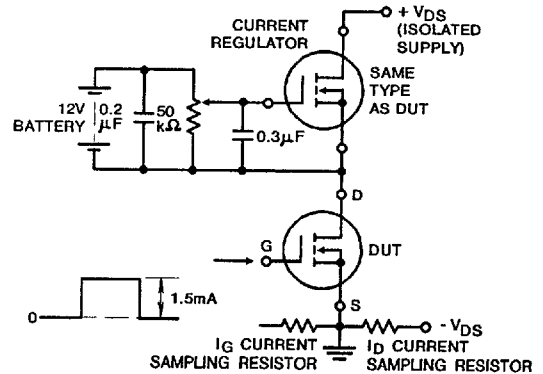

FIGURE 17. GATE CHARGE TEST CIRCUIT