



FEATURES

- PEAK PULSE POWER : 600 W (10/1000μs)
- STAND OFF VOLTAGE RANGE :
From 5V to 188V.
- UNI AND BIDIRECTIONAL TYPES
- LOW CLAMPING FACTOR
- FAST RESPONSE TIME
- JEDEC REGISTERED PACKAGE OUTLINE

DESCRIPTION

The SMBJ series are TRANSIL™ diodes designed specifically for protecting sensitive equipment against transient overvoltages.

Transil diodes provide high overvoltage protection by clamping action. Their instantaneous response to transient overvoltages makes them particularly suited to protect voltage sensitive devices such as MOS Technology and low voltage supplied IC's.

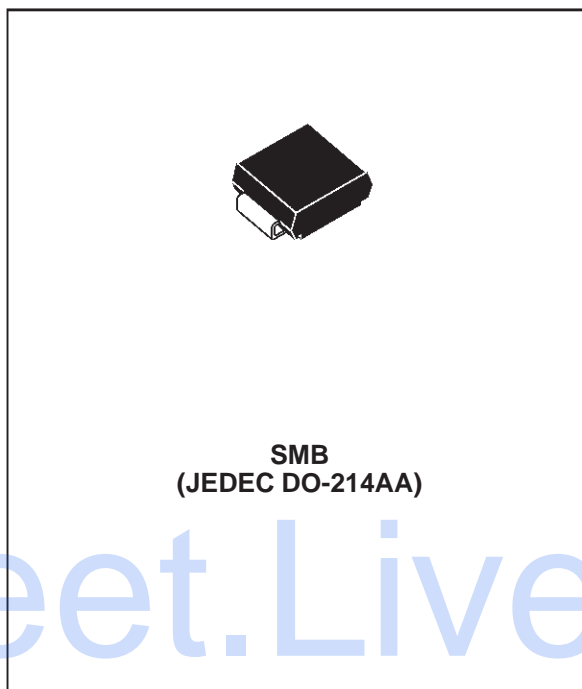

ABSOLUTE MAXIMUM RATINGS (T_{amb} = 25°C)

| Symbol | Parameter | | Value | Unit |
|------------------------------------|--|--|----------------------|----------|
| P _{PP} | Peak pulse power dissipation (see note 1) | T _j initial = T _{amb} | 600 | W |
| P | Power dissipation on infinite heatsink | T _{amb} = 50°C | 5 | W |
| I _{FSM} | Non repetitive surge peak forward current for unidirectional types | tp = 10ms T _j initial = T _{amb} | 100 | A |
| T _{stg} T _j | Storage temperature range Maximum junction temperature | | - 65 to + 175 150 | °C °C |
| T _L | Maximum lead temperature for soldering during 10 s. | | 260 | °C |

Note 1 : For a surge greater than the maximum values, the diode will fail in short-circuit.

THERMAL RESISTANCES

| Symbol | Parameter | Value | Unit |
|-----------------------|--|-------|------|
| R _{th (j-l)} | Junction to leads | 20 | °C/W |
| R _{th (j-a)} | Junction to ambient on printed circuit on recommended pad layout | 100 | °C/W |

SMBJxxxA-TR, CA-TR

ELECTRICAL CHARACTERISTICS (T_{amb} = 25°C)

| Symbol | Parameter |
|-----------------|-----------------------------------|
| V _{RM} | Stand-off voltage |
| V _{BR} | Breakdown voltage |
| V _{CL} | Clamping voltage |
| I _{RM} | Leakage current @ V _{RM} |
| I _{PP} | Peak pulse current |
| α _T | Voltage temperature coefficient |
| V _F | Forward voltage drop |

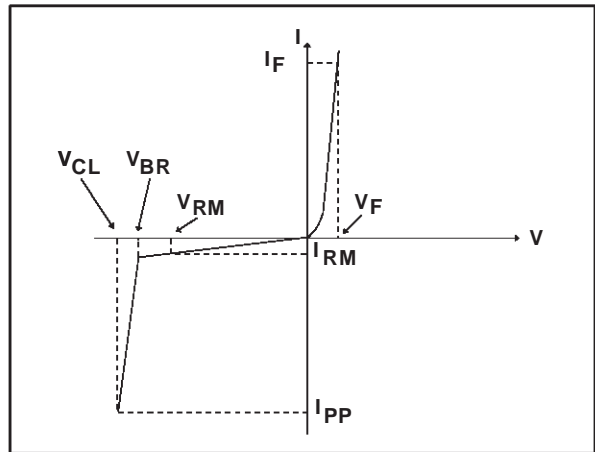

| Types | | | | I _{RM} @ V _{RM} max. | | V _{BR} @ I _R min. note2 | | V _{CL} @ I _{PP} max. 10/1000μs | | V _{CL} @ I _{PP} max. 8/20μs | | α _T max. note3 | C typ. note4 |
|----------------|-------|---------------|-------|---|-----|---|----|--|------|---|------|---------------------------------|--------------------|
| Unidirectional | Mark. | Bidirectional | Mark. | μA | V | V | mA | V | A | V | A | 10 ⁻⁴ /°C | pF |
| SMBJ5.0A-TR | BUZ | SMBJ5.0CA-TR | BBZ | 800 | 5.0 | 6.4 | 10 | 9.2 | 68 | 13.4 | 298 | 5.7 | 4000 |
| SMBJ6.0A-TR | BUA | SMBJ6.0CA-TR | BBA | 800 | 6.0 | 6.7 | 10 | 10.3 | 61 | 13.7 | 290 | 5.9 | 3850 |
| SMBJ6.5A-TR | BUB | SMBJ6.5CA-TR | BBB | 500 | 6.5 | 7.2 | 10 | 11.2 | 56 | 14.5 | 276 | 6.1 | 3700 |
| SMBJ8.5A-TR | BUC | SMBJ8.5CA-TR | BBC | 5 | 8.5 | 9.4 | 1 | 14.4 | 41.7 | 19.5 | 205 | 7.3 | 2800 |
| SMBJ10A-TR | BUD | SMBJ10CA-TR | BBD | 5 | 10 | 11.1 | 1 | 17 | 37 | 21.7 | 184 | 7.8 | 2300 |
| SMBJ12A-TR | BUE | SMBJ12CA-TR | BBE | 5 | 12 | 13.3 | 1 | 19.9 | 31 | 25.3 | 157 | 8.3 | 2025 |
| SMBJ13A-TR | BUF | SMBJ13AC-TR | BBF | 1 | 13 | 14.4 | 1 | 21.5 | 29 | 27.2 | 147 | 8.4 | 1900 |
| SMBJ15A-TR | BUG | SMBJ15CA-TR | BBG | 1 | 15 | 16.7 | 1 | 24.4 | 25.1 | 32.5 | 123 | 8.8 | 1600 |
| SMBJ18A-TR | BUH | SMBJ18CA-TR | BBH | 1 | 18 | 20 | 1 | 29.2 | 21.5 | 39.3 | 102 | 9.2 | 1350 |
| SMBJ20A-TR | BUI | SMBJ20CA-TR | BBI | 1 | 20 | 22.2 | 1 | 32.4 | 19.4 | 42.8 | 93 | 9.4 | 1250 |
| SMBJ22A-TR | BVA | SMBJ22CA-TR | CBH | 1 | 22 | 24.4 | 1 | 35.5 | 17.7 | 48.3 | 83 | 9.6 | 1150 |
| SMBJ24A-TR | BUJ | SMBJ24CA-TR | BBJ | 1 | 24 | 26.7 | 1 | 38.9 | 16 | 50 | 80 | 9.6 | 1112 |
| SMBJ26A-TR | BUK | SMBJ26CA-TR | BBK | 1 | 26 | 28.9 | 1 | 42.1 | 14.9 | 53.5 | 75 | 9.7 | 1075 |
| SMBJ28A-TR | BUL | SMBJ28CA-TR | BBL | 1 | 28 | 31.1 | 1 | 45.4 | 13.8 | 59 | 68 | 9.8 | 1000 |
| SMBJ30A-TR | BUM | SMBJ30CA-TR | BBM | 1 | 30 | 33.3 | 1 | 48.4 | 13 | 64.3 | 62 | 9.9 | 950 |
| SMBJ33A-TR | BUN | SMBJ33CA-TR | BBN | 1 | 33 | 36.7 | 1 | 53.3 | 11.8 | 69.7 | 57 | 10.0 | 900 |
| SMBJ40A-TR | CUJ | SMBJ40CA-TR | CBJ | 1 | 40 | 44.4 | 1 | 64.5 | 9.7 | 84 | 48 | 10.1 | 800 |
| SMBJ48A-TR | BUW | SMBJ48CA-TR | BBW | 1 | 48 | 53.3 | 1 | 77.4 | 8.1 | 100 | 40 | 10.3 | 700 |
| SMBJ58A-TR | BUO | SMBJ58CA-TR | BBO | 1 | 58 | 64.4 | 1 | 93.6 | 6.7 | 121 | 33 | 10.4 | 625 |
| SMBJ70A-TR | CUM | SMBJ70CA-TR | CBM | 1 | 70 | 77.8 | 1 | 113 | 5.5 | 146 | 27 | 10.5 | 550 |
| SMBJ85A-TR | BUQ | SMBJ85CA-TR | BBQ | 1 | 85 | 94.4 | 1 | 137 | 4.6 | 178 | 22.5 | 10.6 | 500 |
| SMBJ100A-TR | CUQ | SMBJ100CA-TR | CBQ | 1 | 100 | 111 | 1 | 162 | 3.8 | 212 | 19 | 10.7 | 450 |
| SMBJ130A-TR | BUS | SMBJ130CA-TR | BBS | 1 | 130 | 144 | 1 | 209 | 3 | 265 | 15 | 10.8 | 400 |
| SMBJ154A-TR | BUT | SMBJ154CA-TR | BBT | 1 | 154 | 171 | 1 | 246 | 2.4 | 317 | 12.6 | 10.8 | 360 |
| SMBJ170A-TR | BUU | SMBJ170CA-TR | BBU | 1 | 170 | 189 | 1 | 275 | 2.2 | 353 | 11.3 | 10.8 | 350 |
| SMBJ188A-TR | BUV | SMBJ188CA-TR | BBV | 1 | 188 | 209 | 1 | 328 | 2 | 388 | 10.3 | 10.8 | 330 |

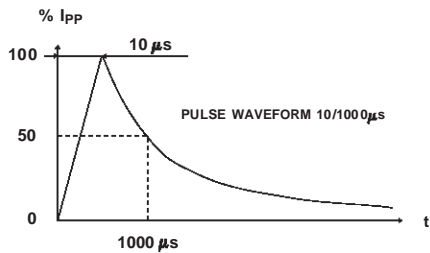

Note 2 : Pulse test : t_p < 50 ms.

Note 3 : ΔV_{BR} = α_T * (T_{amb} - 25) * V_{BR}(25°C).

Note 4 : V_R = 0 V, F = 1 MHz. For bidirectional types, capacitance value is divided by 2.

Fig. 1: Peak pulse power dissipation versus initial junction temperature (printed circuit board).

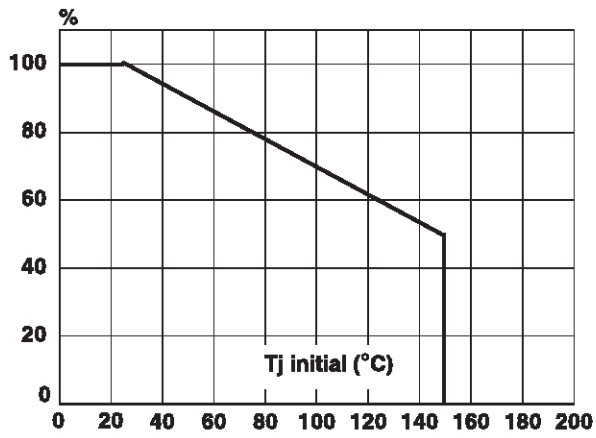
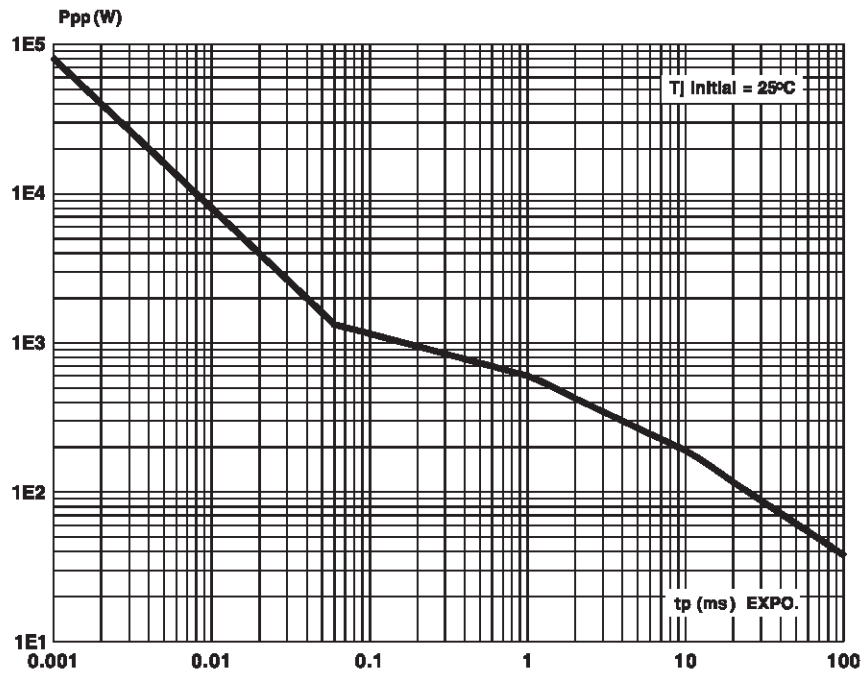
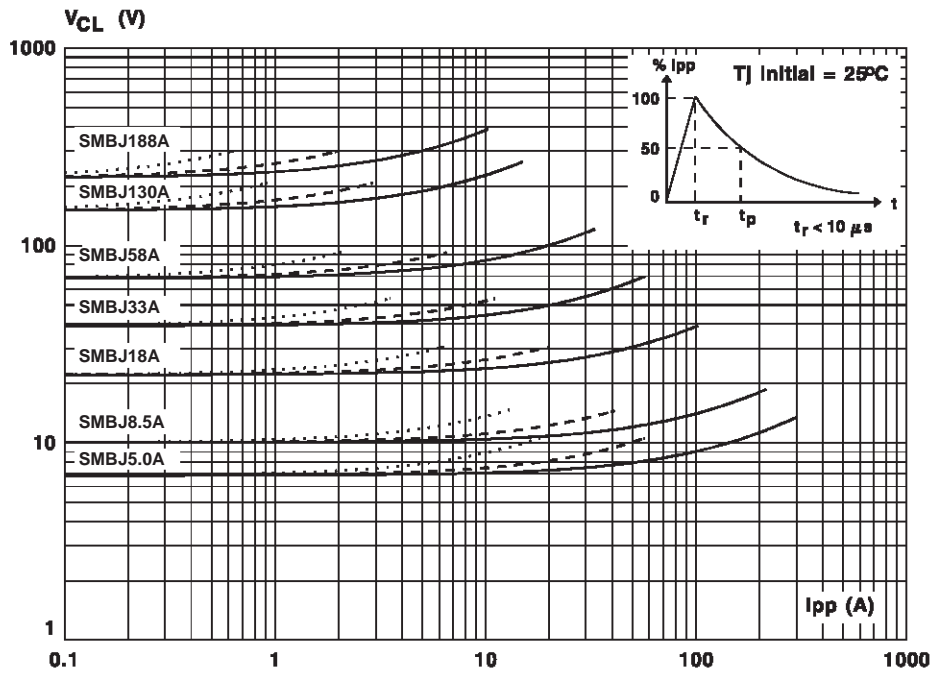

Fig. 2 : Peak pulse power versus exponential pulse duration.



SMBJxxxA-TR, CA-TR

Fig. 3 : Clamping voltage versus peak pulse current.
 Exponential waveform $t_p = 20 \mu s$ _____
 $t_p = 1 ms$ _____
 $t_p = 10 ms$



Note : The curves of the figure 3 are specified for a junction temperature of 25 °C before surge. The given results may be extrapolated for other junction temperatures by using the following formula :
 $\Delta V_{BR} = \alpha T \cdot [T_{amb} - 25] \cdot V_{BR}(25^\circ C)$
 For intermediate voltages, extrapolate the given results.

Fig. 4a : Capacitance versus reverse applied voltage for unidirectional types (typical values).

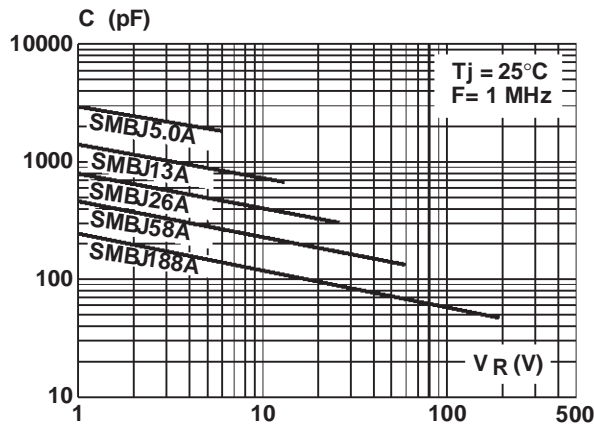

Fig. 4b : Capacitance versus reverse applied voltage for bidirectional types (typical values).

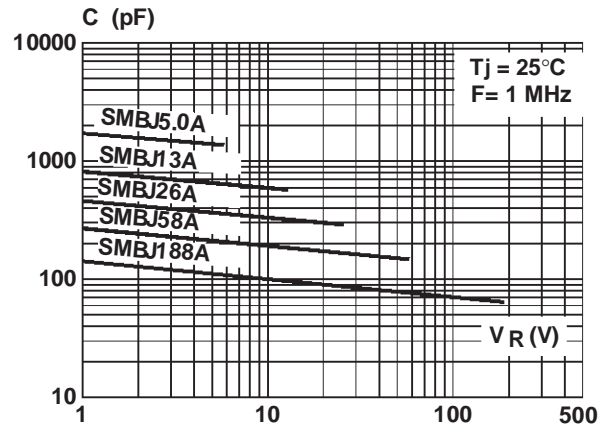

Fig. 5 : Peak forward voltage drop versus peak forward current (typical values for unidirectional types).

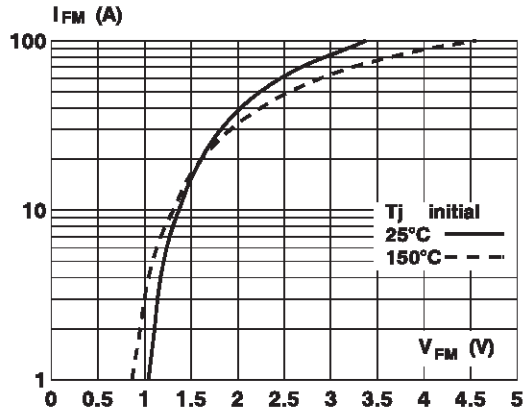

Fig. 6 : Transient thermal impedance junction-ambient versus pulse duration. Mounting on FR4 PC Board with Recommended pad layout.

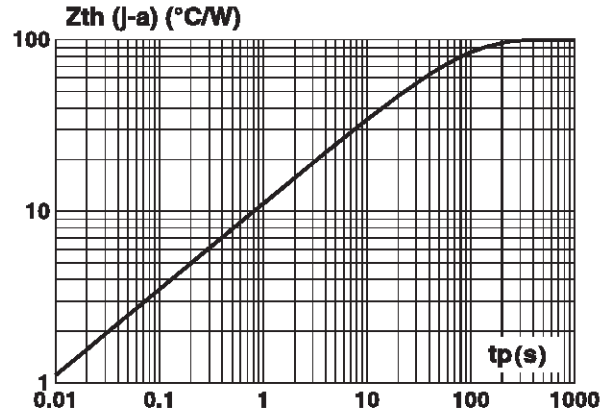
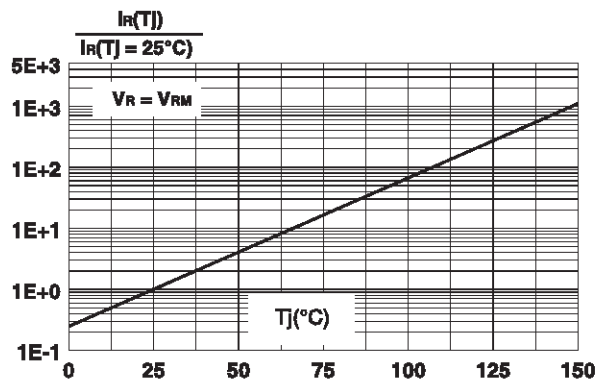
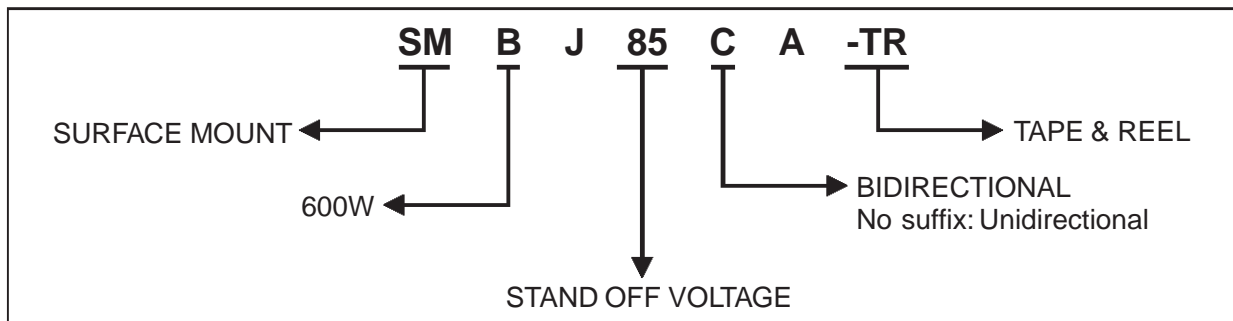

Fig. 7 : Relative variation of leakage current versus junction temperature.



ORDER CODE



SMBJxxxA-TR, CA-TR

MARKING : Logo, Date Code, Type Code, Cathode Band (for unidirectional types only).

PACKAGE MECHANICAL DATA

SMB (Plastic)

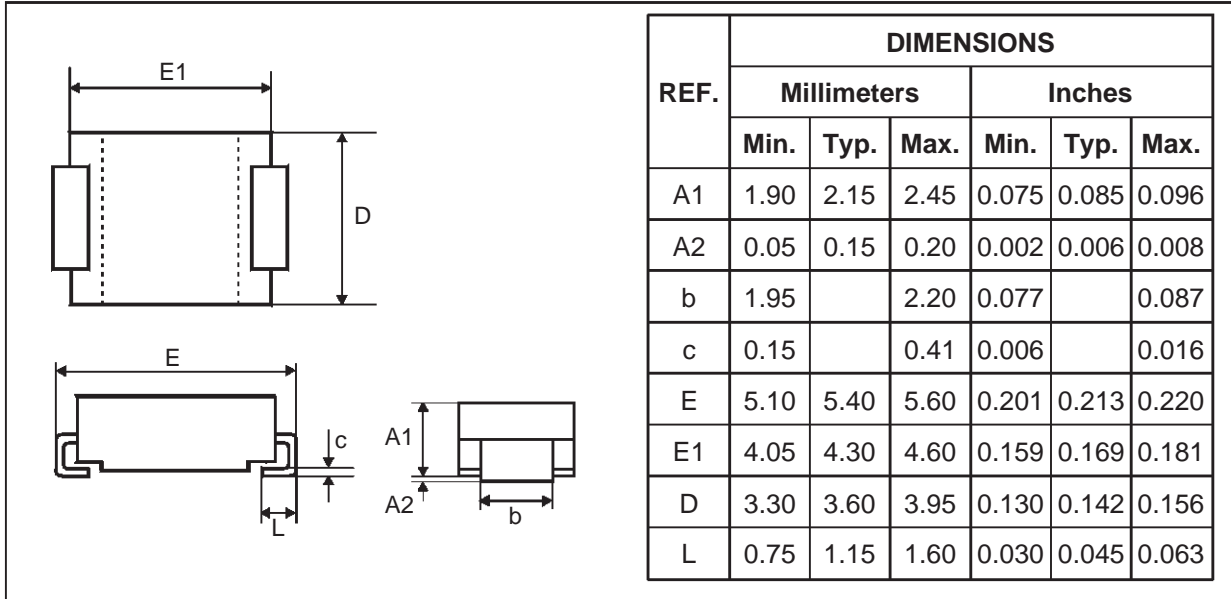

FOOTPRINT DIMENSIONS (Millimeter)

SMD Plastic.

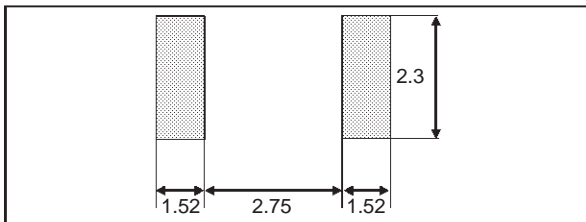

Packaging : standard packaging is in tape and reel.

SOD15 = Standard packaging is in Film.

Weight : 0.12 g

Information furnished is believed to be accurate and reliable. However, STMicroelectronics assumes no responsibility for the consequences of use of such information nor for any infringement of patents or other rights of third parties which may result from its use. No license is granted by implication or otherwise under any patent or patent rights of STMicroelectronics. Specifications mentioned in this publication are subject to change without notice. This publication supersedes and replaces all information previously supplied.

STMicroelectronics products are not authorized for use as critical components in life support devices or systems without express written approval of STMicroelectronics.

The ST logo is a registered trademark of STMicroelectronics

© 2001 STMicroelectronics - Printed in Italy - All rights reserved.

STMicroelectronics GROUP OF COMPANIES

Australia - Brazil - China - Finland - France - Germany - Hong Kong - India - Italy - Japan - Malaysia
 Malta - Morocco - Singapore - Spain - Sweden - Switzerland - United Kingdom - U.S.A.

<http://www.st.com>

