

Intel® Quark™ Microcontroller Developer Kit D2000

User Guide

May 2017

www.datasheet.live



You may not use or facilitate the use of this document in connection with any infringement or other legal analysis concerning Intel products described herein. You agree to grant Intel a non-exclusive, royalty-free license to any patent claim thereafter drafted which includes subject matter disclosed herein

No license (express or implied, by estoppel or otherwise) to any intellectual property rights is granted by this document.

All information provided here is subject to change without notice. Contact your Intel representative to obtain the latest Intel product specifications and roadmaps.

The products described may contain design defects or errors known as errata which may cause the product to deviate from published specifications. Current characterized errata are available on request.

Copies of documents which have an order number and are referenced in this document may be obtained by calling 1-800-548-4725 or by visiting: <http://www.intel.com/design/literature.htm>

Intel technologies' features and benefits depend on system configuration and may require enabled hardware, software or service activation. Learn more at <http://www.intel.com/> or from the OEM or retailer.

No computer system can be absolutely secure.

Intel, Intel Quark, and the Intel logo are trademarks of Intel Corporation in the U.S. and/or other countries.

*Other names and brands may be claimed as the property of others.

Copyright © 2017, Intel Corporation. All rights reserved.



Contents

1.0	Introduction	5
1.1	Terminology.....	5
1.2	Toolchain.....	6
1.3	Reference Documents	6
1.4	Block Diagram	7
2.0	Hardware	8
2.1	Board Components.....	8
2.2	Arduino Shield Sockets Note	9
2.3	Board Photo.....	10
2.4	Board Jumpers	10
2.5	Board Pinouts.....	11
3.0	Software and Tools	13
3.1	Intel® System Studio for Microcontrollers.....	13
3.1.1	Getting Started with Intel® System Studio for Microcontrollers	14
3.1.2	Release Notes.....	14
3.1.3	User and Reference Guide	14
3.2	BSP Release Note	16
3.3	Application Notes.....	16

Figures

Table 1.	Terminology.....	5
Table 2.	Reference Documents for This Installation.....	6
Table 3.	Additional Reference Documents	6
Figure 1.	Intel® Quark™ Microcontroller D2000 Development Platform Block Diagram.....	7
Table 3.	Third Party Board Components: Integrated Circuits.....	8
Figure 2.	Intel® Quark™ Microcontroller D2000 Development Platform Fab D Board Photo	10
Table 5.	Pin Mapping	11

Tables

Table 1.	Terminology.....	5
Table 2.	Reference Documents for This Installation.....	6
Table 3.	Additional Reference Documents	6
Table 4.	3rd Party Board Components: Integrated Circuits.....	8
Table 5.	Pin Mapping	11

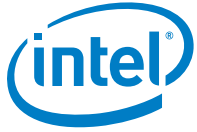

Revision History

Date	Revision	Description
May 2017	006	Updated Sections 2.4, 2.5 , 3.1 and 3.3
November 2016	005	Updated Block Diagram in Section 1.4
August 2016	004	Updated Section 1.0 , Section 1.2 and Section 3.0
May 2016	003	Updated Section 1.0 and Section 2.0
April 2016	002	Booster Pack Pin Mapping added to Table 5.
February 2016	001	Initial release



1.0 Introduction

This document describes Intel® Quark™ Microcontroller D2000 Development Platform including the board, the hardware contained, and the toolchain required for software development and debugging. The platform consists of a small form-factor board and includes flash storage, a 6-axis compass and accelerometer. A USB connection enables programming and debugging (JTAG).

1.1 Terminology

Table 1. Terminology

Term	Description
ADC	Analog-to-Digital conversion
BSP	Board Support Package – Refers to OS + Device Drivers
CRB	Customer Reference Board
ELF	Executable Linkable Format
GDB	GNU Debugger
GPIO	General-Purpose Input / Output
IDE	Integrated Development Environment
I ² C	Inter-Integrated Circuit
JTAG	Joint Test Action Group
MCU	Microcontroller unit
NC	Not Connected
OpenOCD	Open On-Chip Debugger; interfaces with a JTAG port
QFN	Quad Flat No-leads
SPI	Serial Peripheral Interface
UART	Universal Asynchronous Receiver / Transmitter



1.2 Toolchain

The toolchain for programming the D2000 is called *Intel® System Studio for Microcontrollers*.

For details on downloading and installing the toolchain, see [Chapter 3.0, “Software and Tools”](#).

Note: This document focuses on using Intel® System Studio for Microcontrollers but it is not mandatory. The Intel® Quark™ Microcontroller Software Interface BSP and standalone toolchain can be obtained from the Open Source repository at <https://github.com/quark-mcu/qmsi>.

1.3 Reference Documents

This document provides an overview of the setup process. For a successful setup, ensure that you have the documents listed in [Table 2](#) available. These documents provide specific information and step-by-step instructions.

Table 2. Reference Documents for This Installation

Document	Document # / Location
Intel® Quark™ Microcontroller D2000 Developer Kit - Getting Started	www.intel.com/quark/mcu/d2000
Intel® System Studio 2016 for Microcontrollers User and Reference Guide	https://software.intel.com/en-us/issm-2016-user-ref-guide

Table 3. Additional Reference Documents

Document	Document # / Location
Intel® Quark™ Microcontroller D2000 Datasheet	www.intel.com/quark/d2000
Intel® System Studio for Microcontrollers 2016 Release Notes	Included with the S/W Distribution
Intel® Quark™ Microcontroller Software Interface BSP: Release Notes	www.intel.com/quark/d2000
Intel® Quark™ Microcontroller D2000 Development Platform Hardware Manual	www.intel.com/quark/d2000

1.4 Block Diagram

Figure 1. Intel® Quark™ Microcontroller D2000 Development Platform Block Diagram

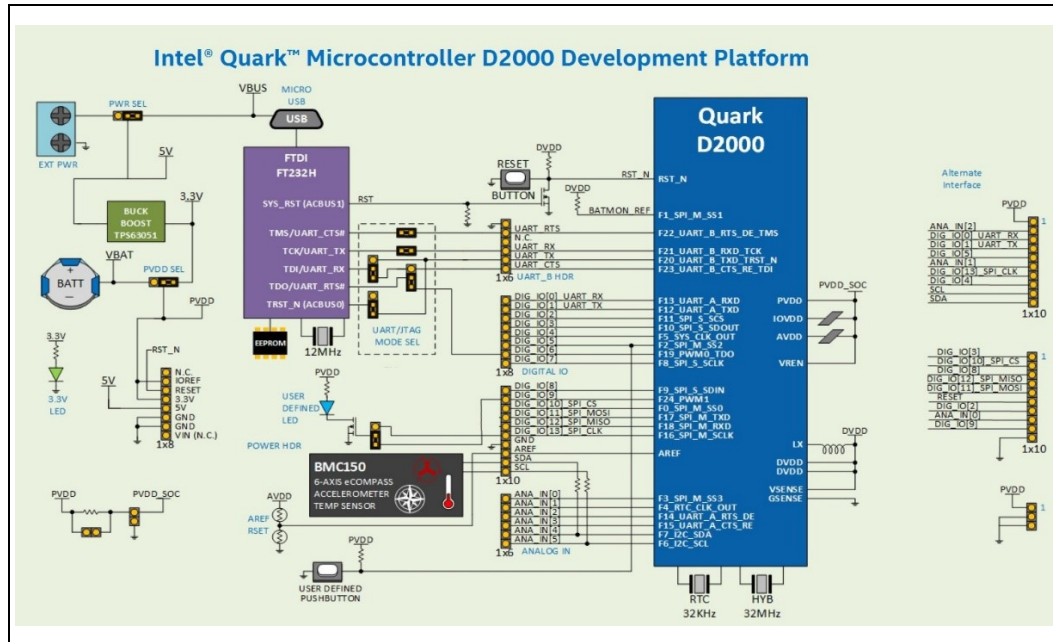

§

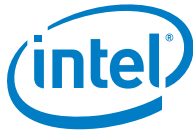

2.0 Hardware

The Intel® Quark™ Microcontroller D2000 package is shipped as a 40-pin QFN component.

2.1 Board Components

The Intel® Quark™ Microcontroller D2000 Development Platform contains the following items:

Main expansion options:

- “Arduino Uno” like SIL sockets (3.3V IO only)
See [Chapter 2.2, “Arduino Shield Sockets Note”](#)
- Booster pack like SIL headers (3.3V IO only)

On-board components:

- 6-axis Accelerometer / Magnetometer with temperature sensor
- UART/JTAG to USB convert for USB debug port

Other connectors include:

- 1x USB 2.0 Device Port – micro Type B
- On-board coin cell battery holder (type CR2032)
- 5V input a screw terminal/header (external power or Li-ion)

Power sources for this platform:

- External (2.5V - 5V) DC input
- USB power (5V) – via debug port
- Coin cell battery (type CR2032 not supplied)

Table 3. Third Party Board Components: Integrated Circuits¹

Component	Manufacturer	Part Number
6-AXIS E Compass and Accelerometer	Bosch Sensortec GMBH	BMC150
SERIAL_EEPROM	Microchip	93LC56BT-I/OT
USB <--> UART & JTAG	FTDI	FT232HL
SPST Switch	E-Switch	TL1015AF160QG
Connector USB - micro B	TE Connectivity	1981568-1
THM Holder for 20mm Coin Cell Batteries	Keystone Electronics CORP.	3003
Single Inductor Buck-Boost With 1-A Switches and Adjustable Soft Start	Texas Instruments	TPS63051RMWT

1. Other names and brands may be claimed as the property of others.

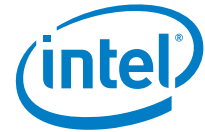

2.2 Arduino Shield Sockets Note

The Intel® Quark™ Microcontroller D2000 Development Platform supports the familiar open standard Arduino Uno Rev 3.0 physical interface and is mechanically compatible with Uno Rev 3.0. It does not support the 6 pin ICSP Header.

Each functional I/O can be configured to provide the same function that is supported on the Arduino Uno Rev 3.0 with the exception of the PWM capability, which can only be supported on IO6 and IO9. The developer platform supports 3.3V IO operation only and is not 5V tolerant. VIN Pin is not supported.

The purpose of supporting the Arduino Uno Rev3.0 form factor is to enable rapid hardware prototyping through leveraging the existing ecosystem of 3.3v Arduino Shields or the Arduino compatible prototyping shields. Software compatibility of any Arduino shield is not assumed and would be the responsibility of the developer to produce the appropriate code.

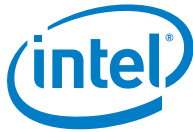

2.3 Board Photo

Figure 2. Intel® Quark™ Microcontroller D2000 Development Platform Fab D Board Photo



2.4 Board Jumpers

1. FTDI UART/JTAG*

J12 and J13 Jumpers are installed for both JTAG and UART by default. To isolate the Intel® Quark™ Microcontroller D2000 from the FTDI FT232HL, remove all the sleeves from Jumpers J9, J10, J11, J15, and J17.

- J9 [2-3] JTAG (Default) [1-2] UART
- J10 [2-3] JTAG (Default) [1-2] UART
- J11 [2-3] JTAG (Default) [1-2] UART

2. Power

- Place J26 Jumper at [1-2] (Default) when the USB Port is in use.
- Place J27 Jumper at [1-2] (Default) when the USB Port is in use.
- J24 Jumper [1-2] (Default)

***Note:** Debug and firmware loading is currently only supported via JTAG. By using UART_B, your application disables the JTAG interface.

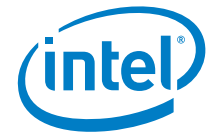

2.5 Board Pinouts

Table 5. Pin Mapping

Pin Label	CRB Pin Usage	Arduino Shield Interface	User Mode0	User Mode1	User Mode2	Booster Pack Pin(s)
J2_1	GND					J13_10, J21_2, J21_3
J2_2	USB port / Hdr		JTAG_TMS	GPIO_22	UART_B_RTS	
J2_3	N/C					
J2_4	USB port / Hdr		JTAG_TCK	GPIO_21	UART_B_RXD	
J2_5	USB port / Hdr		JTAG_TRS_T_N	GPIO_20	UART_B_TXD	
J2_6	USB port / Hdr		JTAG_TDI	GPIO_23	UART_B_CTS	
J3_1	DIO_8	DIO_8	GPIO_9	ADC/COMP9	SPI_S_SDIN	J13_3
J3_2	DIO_09	DIO_09	GPIO_24	-	PWM1	J13_9
J3_3	SPI_M_SSO	SPI_SS_DIO_10	GPIO_0	ADC/COMP0	SPI_M_SSO	J13_2
J3_4	M_MOSI/DIO_11	MOSI/DIO_11	GPIO_17	ADC/COMP17	SPI_M_DOUT	J13_5
J3_5	M_MISO/DIO_12	MISO/DIO_12	GPIO_18	ADC/COMP18	SPI_M_DIN	J13_4
J3_6	M_SCK/DIO_13	SCK/DIO_13	GPIO_16	ADC/COMP16	M_SCK/DIO_13	J8_7
J3_7	GND					
J3_8	AREF					
J3_9	SDA/AIN_04	SDA/AIN_04/DIO_18	GPIO_7	ADC/COMP7	I2C_SDA	J8_10
J3_10	SCL/AIN_05	SCL/AIN_05/DIO_19	GPIO_6	ADC/COMP6	I2C_SCL	J8_9
J4_1	UART_RXD/DIO_00	UART_RXD/DIO_00	GPIO_13	ADC/COMP13	UART_A_RXD	J8_3
J4_2	UART_TXD/DIO_01	UART_TXD/DIO_01	GPIO_12	ADC/COMP12	UART_A_TXD	J8_4
J4_3	DIO_02	DIO_02	GPIO_11	ADC/COMP11	SPI_S_SCS	J13_7
J4_4	DIO_03	DIO_03	GPIO_10	ADC/COMP10	SPI_S_SDOOUT	J13_1
J4_5	DIO_04	DIO_04	GPIO_5	ADC/COMP5	SYS_CLK_OUT	J8_8

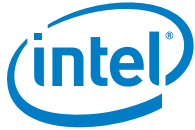

Pin Label	CRB Pin Usage	Arduino Shield Interface	User Mode0	User Mode1	User Mode2	Booster Pack Pin(s)
J4_6	DIO_05	DIO_05	GPIO_2	ADC/COMP2	SPI_M_SS2	J8_5
J4_7	USB port/DIO_06	DIO_06	JTAG_TDO	GPIO_19	PWM0	
J4_8	DIO_07	DIO_07	GPIO_8	ADC/COMP8	SPI_S_SCLK	
J22_1	NC					
J22_2	IOREF					
J22_3	RESET_N	RESET_N	RST_N			J13_6
J22_4	3.3V					J8_1, J21_1
J22_5	5V					
J22_6	GND					
J22_7	GND					
J22_8	NC					
J23_1	AIN_00	AIN_00	GPIO_3	ADC/COMP3	SPI_M_SS3	J13_8
J23_2	AIN_01	AIN_01	GPIO_4	ADC/COMP4	RTC_CLK_OUT	J8_6
J23_3	AIN_02	AIN_02	GPIO_14	ADC/COMP14	UART_A_RTS	J8_2
J23_4	AIN_03	AIN_03	GPIO_15	ADC/COMP15	UART_A_CTS	
J23_5	AIN_04 / SDA	SDA/AIN_04/DIO_18	GPIO_7	ADC/COMP7	I2C_SDA	J8_10
J23_6	AIN_05 / SCL	SCL/AIN_05/DIO_19	GPIO_6	ADC/COMP6	I2C_SCL	J8_9

§



3.0 Software and Tools

3.1 Intel® System Studio for Microcontrollers

Intel® System Studio 2016 for Microcontrollers is an Eclipse*-integrated tool set for developing, optimizing, and debugging systems and applications for the Intel® Quark™ Microcontroller D2000 and Intel® Quark™ SE Microcontroller C1000 targets.

The package integrates the Board Support Package (BSP) for Intel® Quark™ Microcontroller Software Interface (Intel® QMSI) and all tools to cross-compile, flash, and debug on Linux* and Windows* host platforms.

In addition, this package provides support of [Zephyr* RTOS](#), a small-footprint kernel designed for use on resource-constrained systems. As part of Intel® System Studio 2016 for Microcontrollers, along with bare-metal, the option is given for users to create Zephyr-based projects, which will run on their Intel® Quark™ microcontroller platforms.

The tool set consists of the following components:

- GCC* Version 5.2.1 for Intel® architecture
 - Linker
 - Assembler
 - C run-time Libraries
- GCC* Version 4.8.5 for the Sensor Subsystem in Intel® Quark™ SE Microcontroller C1000
 - Linker
 - Assembler
 - C run-time Libraries
- Board Support Package (BSP) for Intel® QMSI
- Floating Point Emulation library
- Eclipse* Neon 4.6 including Intel® System Studio 2016 for Microcontrollers integration
- GNU GDB* 7.9
- Java* 64 bit Standard Edition Runtime Environment 1.8
- Intel® Compiler for Intel® Quark™ Microcontrollers - 2016.0
- Energy Analysis for Microcontrollers
- Intel® Integrated Performance Primitives for Microcontrollers 1.2.0
- Intel® QMSI 1.4.0
- MRAA IO Communication Layer / UPM Sensor and Actuator Library



- OpenOCD* 0.8.0 JTAG Debugger
- Python* 2.7.10 and 3.6.0
- Sample Applications
- Standard and optimized math library [libm]
- TinyCrypt* 0.2.6 (Internet connection required during installation)
- WinUSB* driver for Intel® Quark™ microcontrollers
- Zephyr* OS 1.7.0

The suite is supported on the following host operating systems:

- Windows* (64-bit Versions 7, 8.1, and 10)
- Linux* (64-bit Ubuntu* 16.04 LTS, and Fedora* 25)

3.1.1 Getting Started with Intel® System Studio for Microcontrollers

Installing the IDE begins by following the link printed on the Developer Kit box (www.intel.com/quark/mcu/d2000). Follow the instructions on this page to get your board connected and the IDE installed.

Once the IDE is launched follow the instructions on the 'Getting Started' page to build and deploy a project.

3.1.2 Release Notes

Intel® System Studio for Microcontrollers 2016 Release Notes. The release notes contain all system requirements and prerequisites. Known issues and workarounds are also included.

<i>Intel® System Studio for Microcontrollers 2016 Release Notes</i>	Distributed with toolchain
---	----------------------------

3.1.3 User and Reference Guide

The *Intel® System Studio 2016 for Microcontrollers User and Reference Guide* located in `issm_user_ref_guide.htm` contains more detailed information about this tool suite, including:

- Developing in the IDE and on the Command Line
- Using the compilers
- Using Intel® Integrated Performance Primitives for Microcontrollers (Intel® IPP for Microcontrollers)
- Using the Floating Point Library

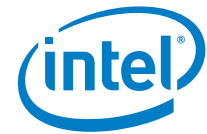

- Using the TiinyCrypt library

Follow the detailed, step-by-step instructions in:

<i>Intel® System Studio 2016 for Microcontrollers User and Reference Guide</i>	Distributed in toolchain
--	--------------------------

NOTE: The *Intel® System Studio 2016 for Microcontrollers User and Reference Guide* is a separate document and should be followed at this point.



3.2 BSP Release Note

The *Intel® Quark™ Microcontroller Software Interface BSP Release Notes* contain release-specific information, including:

- Notes about the Board Support Package
- Installation instructions
- Details on provided utilities and applications
- Known issues and workarounds.
- Supported features of the release.

3.3 Application Notes

Document	Document # / Location
Intel® Quark™ Microcontroller D2000 - Enabling DHT11 Humidity Sensor: Application Note	www.intel.com/quark/d2000