

## Small Signal Transistors (PNP)

### Features

- PNP Silicon Epitaxial Planar Transistors for switching and amplifier applications. Especially suitable for AF-driver stages and low-power output stages.
- These types are also available subdivided into three groups, -16, -25, and -40, according to their DC current gain. As complementary types, the NPN transistors BC337 and BC338 are recommended.

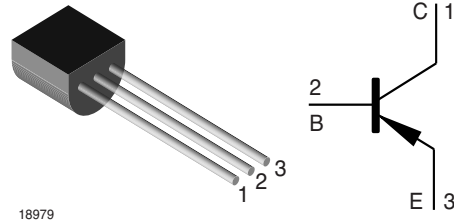

### Mechanical Data

**Case:** TO-92 Plastic Package

**Weight:** approx. 177 mg

**Packaging Codes/Options:**

BULK / 5 k per container 20 k/box

TAP / 4 k per Ammopack 20 k/box

### Parts Table

Part	Type differentiation	Ordering code	Remarks
BC327-16	$h_{FE}$ , typ. 160 @ 100 mA	BC327-16-BULK or BC327-16-TAP	Bulk / Ammopack
BC327-25	$h_{FE}$ , typ. 250 @ 100 mA	BC327-25-BULK or BC327-25-TAP	Bulk / Ammopack
BC327-40	$h_{FE}$ , typ. 400 @ 100 mA	BC327-40-BULK or BC327-40-TAP	Bulk / Ammopack
BC328-16	$h_{FE}$ , typ. 130 @ 300 mA	BC328-16-BULK or BC328-16-TAP	Bulk / Ammopack
BC328-25	$h_{FE}$ , typ. 200 @ 300 mA	BC328-25-BULK or BC328-25-TAP	Bulk / Ammopack
BC328-40	$h_{FE}$ , typ. 320 @ 300 mA	BC328-40-BULK or BC328-40-TAP	Bulk / Ammopack

### Absolute Maximum Ratings

$T_{amb} = 25\text{ }^{\circ}\text{C}$ , unless otherwise specified

Parameter	Test condition	Part	Symbol	Value	Unit
Collector - emitter voltage		BC327	$-V_{CES}$	50	V
		BC328	$-V_{CES}$	30	V
		BC327	$-V_{CEO}$	45	V
		BC328	$-V_{CEO}$	25	V
Emitter - base voltage			$-V_{EBO}$	5	V
Collector current			$-I_C$	800	mA
Peak collector current			$-I_{CM}$	1	A
Base current			$-I_B$	100	mA
Power dissipation	$T_{amb} = 25\text{ }^{\circ}\text{C}$		$P_{tot}$	625 <sup>1)</sup>	mW

<sup>1)</sup> Valid provided that leads are kept at ambient temperature at a distance of 2 mm from case.

### Maximum Thermal Resistance

Parameter	Test condition	Symbol	Value	Unit
Thermal resistance junction to ambient air		$R_{\theta JA}$	200 <sup>1)</sup>	°C/W
Junction temperature		$T_j$	150	°C
Storage temperature range		$T_S$	- 65 to + 150	°C

<sup>1)</sup> Valid provided that leads are kept at ambient temperature at a distance of 2 mm from case.

### Electrical DC Characteristics

Parameter	Test condition	Part	Symbol	Min	Typ	Max	Unit
DC current gain (current gain grup - 16)	- $V_{CE} = 1 \text{ V}$ , - $I_C = 100 \text{ mA}$	BC327-16	$h_{FE}$	100	160	250	V
DC current gain (current gain grup - 25)	- $V_{CE} = 1 \text{ V}$ , - $I_C = 100 \text{ mA}$	BC327-25	$h_{FE}$	160	250	400	V
DC current gain (current gain grup - 40)	- $V_{CE} = 1 \text{ V}$ , - $I_C = 100 \text{ mA}$	BC327-40	$h_{FE}$	250	400	630	V
DC current gain (current gain grup - 16)	- $V_{CE} = 1 \text{ V}$ , - $I_C = 300 \text{ mA}$	BC328-16	$h_{FE}$	60	130		V
DC current gain (current gain grup - 25)	- $V_{CE} = 1 \text{ V}$ , - $I_C = 300 \text{ mA}$	BC328-25	$h_{FE}$	100	200		V
DC current gain (current gain grup - 40)	- $V_{CE} = 1 \text{ V}$ , - $I_C = 300 \text{ mA}$	BC328-40	$h_{FE}$	170	320		V
Collector - emitter cutoff current	- $V_{CE} = 45 \text{ V}$	BC327	- $I_{CES}$		2	100	nA
	- $V_{CE} = 25 \text{ V}$	BC328	- $I_{CES}$		2	100	nA
	- $V_{CE} = 45 \text{ V}$ , $T_{amb} = 125 \text{ °C}$	BC327	- $I_{CES}$			10	μA
	- $V_{CE} = 25 \text{ V}$ , $T_{amb} = 125 \text{ °C}$	BC328	- $I_{CES}$			10	μA
Collector saturation voltage	- $I_C = 500 \text{ mA}$ , - $I_B = 50 \text{ mA}$		- $V_{CEsat}$			0.7	V
Base - emitter voltage	- $V_{CE} = 1 \text{ V}$ , - $I_C = 300 \text{ mA}$		- $V_{BE}$			1.2	V
Collector - emitter breakdown voltage	- $I_C = 10 \text{ mA}$	BC327	- $V_{(BR)CEO}$	45			V
		BC328	- $V_{(BR)CEO}$	25			V
	- $I_C = 0.1 \text{ mA}$	BC327	- $V_{(BR)CEO}$	50			V
		BC328	- $V_{(BR)CES}$	30			V
Emitter - base breakdown voltage	- $I_E = 0.1 \text{ mA}$		- $V_{(BR)EBO}$	5			V

### Electrical AC Characteristics

Parameter	Test condition	Symbol	Min	Typ	Max	Unit
Gain - bandwidth product	- $V_{CE} = 5 \text{ V}$ , - $I_C = 10 \text{ mA}$ , $f = 50 \text{ MHz}$	$f_T$		100		MHz
Collector - base capacitance	- $V_{CB} = 10 \text{ V}$ , $f = 1 \text{ MHz}$	$C_{CBO}$		12		pF

## Typical Characteristics ( $T_{amb} = 25\text{ }^{\circ}\text{C}$ unless otherwise specified)

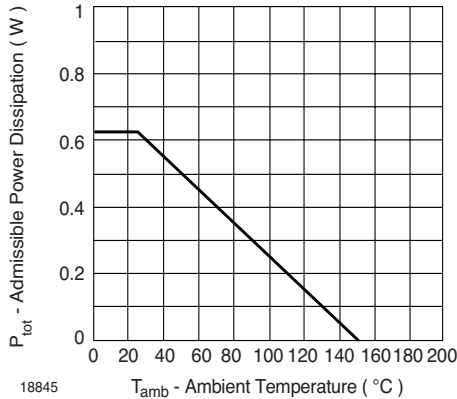

Fig. 1 Admissible Power Dissipation vs. Ambient Temperature

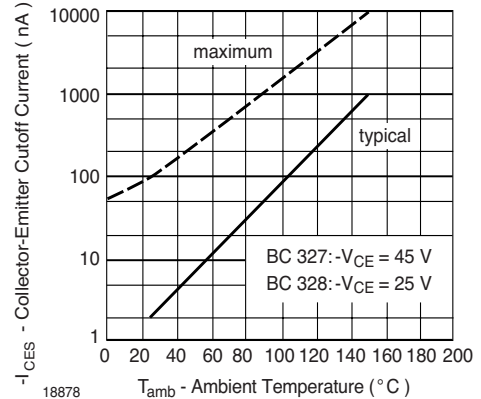

Fig. 4 Collector-Emitter Cutoff Current vs. Ambient Temperature

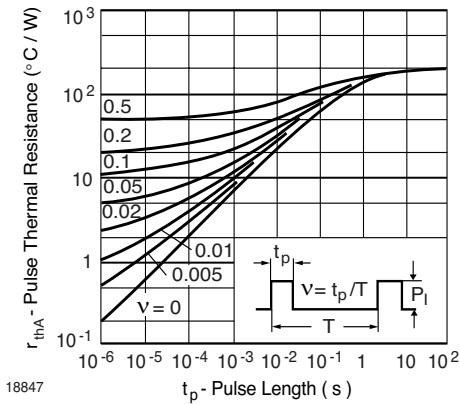

Fig. 2 Pulse Thermal Resistance vs. Pulse Duration

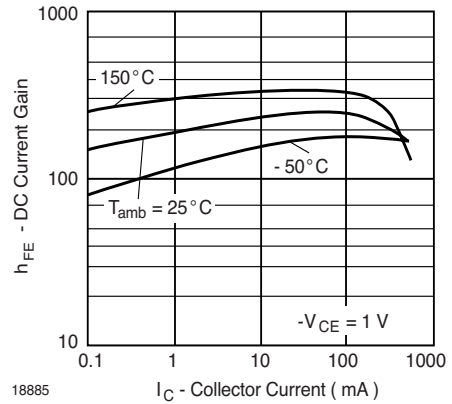

Fig. 5 DC Current Gain vs. Collector Current

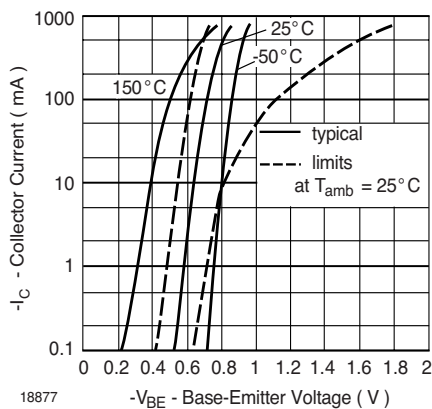

Fig. 3 Collector Current vs. Base-Emitter Voltage

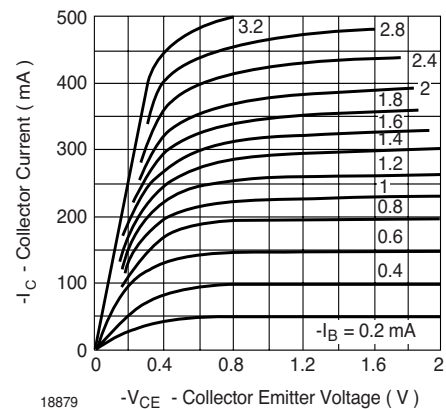

Fig. 6 Common Emitter Collector Characteristics

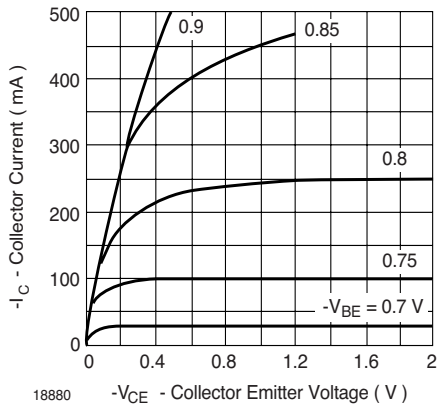

Fig. 7 Common Emitter Collector Characteristics

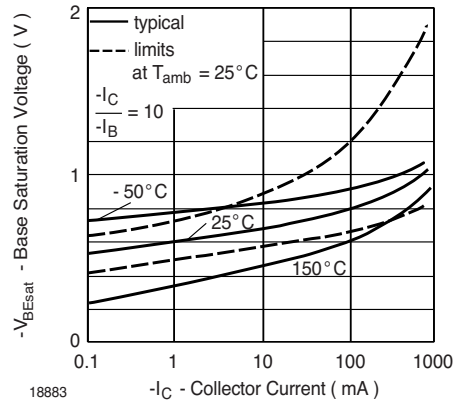

Fig. 10 Base Saturation Voltage vs. Collector Current

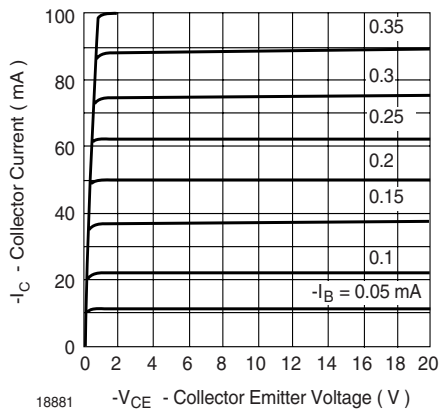

Fig. 8 Common Emitter Collector Characteristics

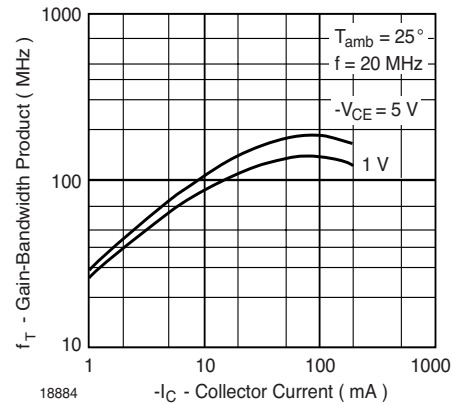

Fig. 11 Gain-Bandwidth Product vs. Collector Current

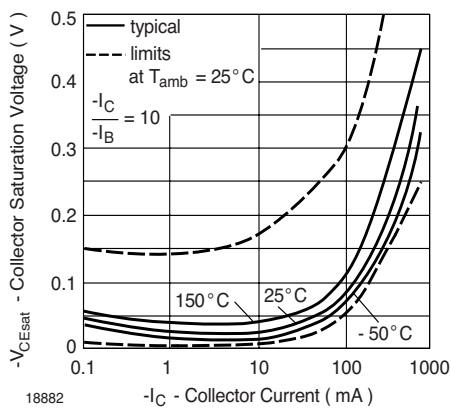
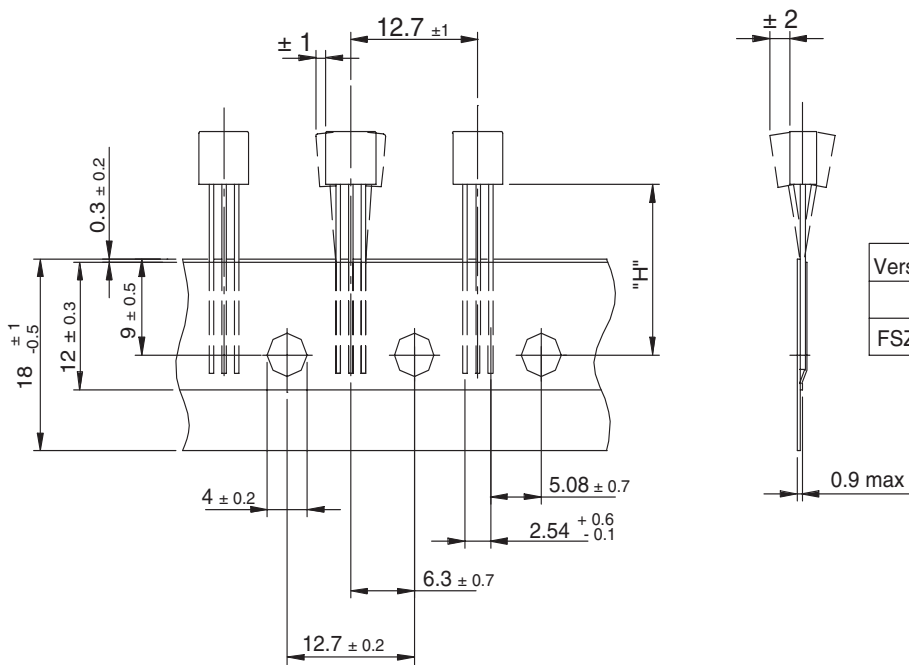
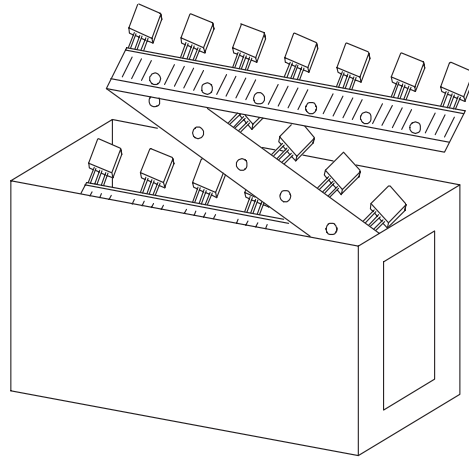

Fig. 9 Collector Saturation Voltage vs. Collector Current

## Packaging for Radial Taping



Vers.	Dim. "H"
FSZ	27 ± 0.5

Measure limit over 20 index - holes: ± 1

18787

# BC327 / BC328

Vishay Semiconductors



## Package Dimensions in mm (Inches)

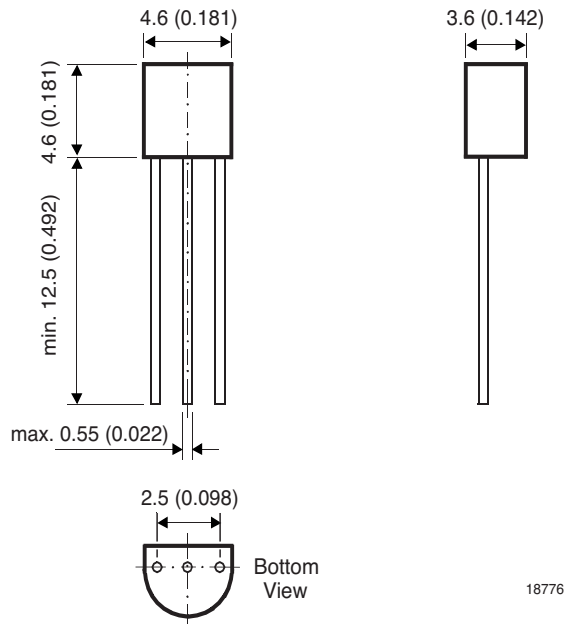

18776

## **Ozone Depleting Substances Policy Statement**

It is the policy of **Vishay Semiconductor GmbH** to

1. Meet all present and future national and international statutory requirements.
2. Regularly and continuously improve the performance of our products, processes, distribution and operating systems with respect to their impact on the health and safety of our employees and the public, as well as their impact on the environment.

It is particular concern to control or eliminate releases of those substances into the atmosphere which are known as ozone depleting substances (ODSs).

The Montreal Protocol (1987) and its London Amendments (1990) intend to severely restrict the use of ODSs and forbid their use within the next ten years. Various national and international initiatives are pressing for an earlier ban on these substances.

**Vishay Semiconductor GmbH** has been able to use its policy of continuous improvements to eliminate the use of ODSs listed in the following documents.

1. Annex A, B and list of transitional substances of the Montreal Protocol and the London Amendments respectively
2. Class I and II ozone depleting substances in the Clean Air Act Amendments of 1990 by the Environmental Protection Agency (EPA) in the USA
3. Council Decision 88/540/EEC and 91/690/EEC Annex A, B and C (transitional substances) respectively.

**Vishay Semiconductor GmbH** can certify that our semiconductors are not manufactured with ozone depleting substances and do not contain such substances.

**We reserve the right to make changes to improve technical design  
and may do so without further notice.**

Parameters can vary in different applications. All operating parameters must be validated for each customer application by the customer. Should the buyer use Vishay Semiconductors products for any unintended or unauthorized application, the buyer shall indemnify Vishay Semiconductors against all claims, costs, damages, and expenses, arising out of, directly or indirectly, any claim of personal damage, injury or death associated with such unintended or unauthorized use.

Vishay Semiconductor GmbH, P.O.B. 3535, D-74025 Heilbronn, Germany  
Telephone: 49 (0)7131 67 2831, Fax number: 49 (0)7131 67 2423