

ВВЕДЕНИЕ

Впервые, сделана столь масштабная попытка, разобраться с маркировкой компонентов поверхностного монтажа (SMD).

Конечно, книга не является панацеей, но на взгляд авторов должна существенно помочь в той неразберихе, которая царит в области маркировки электронных компонентов.

Небольшой формат книги обусловлен желанием, чтобы она поместилась в карман и всегда была под рукой, т. к. удержать в голове приведенную информацию не представляется возможным.

ЭТО НЕОБХОДИМО ЗНАТЬ

Для того чтобы правильно воспринимать и использовать материал, представленный в этой книге, необходимо ознакомиться со следующей информацией:

1. Очень важны размеры корпусов, потому что внешне многие корпуса очень похожи друг на друга, а для идентификации прибора необходимо знать не только маркировку, но и тип корпуса. Но и это может не спасти. Так корпус типа SOD80 у фирмы PHILIPS имеет диаметр 1.6 мм (ном.), а корпус с таким же названием у ряда других фирм имеет диаметр 1.4 мм, что даже меньше диаметра другого, более компактного, корпуса фирмы PHILIPS SOD80C. Корпус типа SOD15 фирмы SGS-Thomson очень похож на корпуса 7043 и SMC, но не совпадает с ними по установочным размерам (см. таблицу 2 в главе «Корпус для монтажа на поверхность (SMD)»).

SOD80

7343

SMC

SOD15



2. Возможны ситуации, когда в один и тот же корпус фирмы-производители под одной и той же маркировкой помещают разные приборы, например, фирма PHILIPS помещает в корпус типа SOT323 NPN-транзистор типа BC818W и маркирует его кодом 6H, а фирма MOTOROLA в такой же корпус с маркировкой 6H помещает PNP-транзистор типа MVN5131T1. Такая же ситуация встречается и внутри одной фирмы. Например, в корпусе типа SOT23 у фирмы SIEMENS под маркировкой 1A выпускаются транзисторы BC846A и SMBT3904, обладающие разными параметрами. Различить такие приборы установленные на плате можно только по окружающим их компонентам и соответственно – схеме включения.

BC818W
(PHILIPS)

MVN5131T1
(MOTOROLA)

BC846A
(SIEMENS)

SMBT3904
(SIEMENS)



SOT323



SOT 23

3. Путаница существует не только с маркировкой, но и цоколевкой корпусов. Например, корпус типа SOT-89 у фирм ROHM, SIEMENS, TOSHIBA имеет цоколевку 1-2-3 (вид сверху), а у PHILIPS этот же корпус имеет цоколевку 2-3-1 или 3-2-1. В данной книге номера выводов и их функциональное значение у разных фирм приведены к единому знаменателю.
4. Не лучше ситуация и с пассивными компонентами для поверхностного монтажа. Если на корпусе, (см. главу «Корпуса для монтажа на поверхность (SMD)») стоит маркировка 103, то это может быть резистор номиналом 10 кОм, конденсатор – емкостью 10 нФ или индуктивность на 10 мГн. Если на корпусе стоит маркировка 2R2, то это может быть и резистор с номиналом 2.2 Ома, и конденсатор с емкостью 2.2 пФ. Код 107 может означать 0.1 Ома (Philips) или 100 мкФ (Panasonic).
5. В корпусах типа 0603, 0805 и т. п. Без маркировки могут находиться конденсатор, индуктивность или резистор-перемычка (Zero-Ohm, jumper).
6. Цветная полоса или выемка-ключ на корпусах типа SOD123, DO215 может указывать на катод диода или вывод «плюс» у электролитического конденсатора.

⊕ КОНДЕНСАТОРА КАТОД ДИОДА ИЛИ СТАБИЛИТРОНА

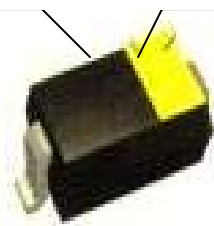

SOD123

7. По внешнему виду очень трудно отличить друг от друга R, C и L, если они находятся в цилиндрических корпусах с выводами и маркируются цветными кольцами. Сложности могут возникнуть, и после идентификации элемента с определением его параметров. Например, на практике для цветовой маркировки постоянных конденсаторов используются несколько методик маркировки (см. главу «Конденсаторы. Цветовая маркировка»).



8. В совершенно одинаковых корпусах с одинаковым цветовым кодом может выпускаться целая серия приборов с совершенно разными параметрами. Например, фирма MOTOROLA выпускает в корпусе типа SOD80, маркируемого одним цветным кольцом, целую серию стабилитронов (51 прибор) с напряжением стабилизации от 1.8 до 100 В и током от 0.1 до 1.7 А. В таком же корпусе фирма PHILIPS выпускает серию диодов.
9. Необходимо внимательно определять сам цвет маркировки. На практике и в этой книге могут встречаться сложности с различием следующих оттенков: серый – св. голубой – серебристый; голубой – бирюзовый – электрик; желтый – золотистый; оранжевый – св. коричневый – табачный – бежевый.
10. Черное кольцо посередине корпуса могут иметь не только резисторы-перемычки (Zero-Ohm, jumper), но и другие приборы, особенно с учетом технологического разброса при нанесении маркировки.
11. Многие фирмы используют помимо принципов маркировки указанных в Публикациях Международной Электротехнической Комиссии (IEC) свою – внутрифирменную цветовую и кодовую маркировки. Например, встречается маркировка SMD-резисторов, когда вместо цифры 8 ставится двоеточие. В таких случаях маркировка **1:23** означает 182 кОм, а а **:0R6** – 80.6 Ом.
12. Корпуса типа SOT (SOD) – Small Outline Transistor (Diode) - в дословном переводе означают «транзистор (диод) с маленькими выводами». На современном этапе в корпуса типа SOT помещают не только транзисторы и диоды, но и транзисторы с резисторами, стабилитроны напряжения на базе операционного усилителя и многое другое и количество выводов бывает более трех. Стандартизирующие органы не успевают за новыми разработками фирм, и те вынуждены вводить свои новые обозначения. Более подробную информацию см. в главе «Корпуса».

КОРПУСА

компонентов для поверхностного монтажа (SMD)

Несмотря на большое количество стандартов, регламентирующих требования к корпусам электронных компонентов, многие фирмы выпускают элементы в корпусах не соответствующих международным стандартам. Также встречаются ситуации, когда корпус, имеющий стандартные размеры у фирмы имеет другое название.

Часто название корпуса состоит из четырех цифр, которые отображают его длину и ширину. Но в одних стандартах эти параметры задаются в дюймах, в других – в миллиметрах. Так, например, название корпуса 0805 получается следующим образом: 0805=L x W=(0.08 x 0.05) дюйма. А корпус 5845 имеет габариты (5.8 x 4.5) мм. Корпуса с одним и тем же названием могут иметь разную высоту, различные контактные площадки, и выполнены из различных материалов, но рассчитаны для монтажа на стандартное установочное место. Ниже приведены параметры (мм) наиболее популярных типов корпусов.

Резисторы
Конденсаторы
Индуктивности
Термисторы
Варисторы



Таблица 1.

Тип корпуса	L* (мм)	W* (мм)	H* (мм)	K (мм)	Примечание
0402 (1005)	1.0	0.5	0.35...0.55	0.2	
0603(1608)	1.6	0.8	0.45...0.95	0.3	
0805(2012)	2.0	1.25	0.4...1.6	0.5	ГОСТ P1-12-0.062
1206(3216)	3.2	1.6	0.4...0.75	0.5	ГОСТ P1-12-0.125; P1-16
1210(3225)	3.2	2.5	0.55...1.9	0.5	
2118(3245)	3.2	4.5	0.55...1.9	0.5	
1806(4516)	4.5	1.6	1.6	0.5	
1208(4520)	4.5	2.0	2.0	0.5	
1812(4532)	4.5	3.2	0.6..3.2	0.5	
2010(5025)	5.0	2.5	0.55	0.5	
2220(5750)	5.7	5.0	1.7	0.5	
2225(5763)	5.7	6.3	2.0	0.5	
2512(6432)	6.4	3.2	2.0	0.5	
2824(7161)	7.1	6.1	3.9	0.5	
3225(8063)	8.0	6.3	3.2	0.5	
4030	10.2	7.6	3.9	0.5	
4032	10.2	8.0	3.2	0.5	
5040	12.7	10.2	4.8	0.5	
6054	15.2	13.7	4.8	0.5	

*- в зависимости от технологий, которыми обладает фирма, варьируется и нормируемые разбросы относительно базовых габаритов. Наиболее распространенные допуски: $\pm 0,05$ мм корпуса длиной до 1мм, например, 0402; $\pm 0,1$ мм – до 2 мм, например, SOD-232; ± 0.2 мм – до 5 мм; $\pm 0,5$ мм – выше 5 мм.

Небольшие расхождения в цифрах у разных фирм обусловлены степенью точности перевода дюймов в мм, а так же указанием только min, max или номинального размера.

** - Корпуса с одним и тем же названием могут иметь разную высоту.

Это обусловлено: для конденсаторов - величиной емкости и рабочим напряжением, для резисторов- рассеиваемой мощности, и т.д.

Диоды
Стабилитроны
Конденсаторы
Индуктивности
Термисторы
Варисторы



Таблица 2.

Тип корпуса	L* (мм)	W* (мм)	H** (мм)	F (мм)	Примечание
2012(0805)	2.0	1.2	1.2	1.1	EIAJ
3216(1206)	3.2	1.6	1.6	1.2	EIAJ
3216L	3.2	1.6	1.2	1.2	EIAJ
3528	3.5	2.8	1.9	2.2	EIAJ
3528L	3.5	2.8	1.2	2.2	EIAJ
5832	5.8	3.2	1.5	2.2	-
5845	5.8	4.5	3.1	2.2	EIAJ
6032	6.0	3.2	2.5	2.2	EIAJ
7343	7.3	4.3	2.8	2.4	EIAJ
7343H	7.3	4.3	4.3	2.4	EIAJ
DO-214AA	5.4	3.6	2.3	2.05	JEDEC
DO-214AB	7.95	5.9	2.3	3.0	JEDEC
DO-214AC	5.2	2.6	2.4	1.4	JEDEC
DO-214BA	5.25	2.6	2.95	1.3	JEDEC
SMA	5.2	2.6	2.3	1.45	MOTROLA
SMB	5.4	2.6	2.3	2.05	MOTROLA
SMC	7.95	5.9	2.3	3.0	MOTROLA
SOD 6	5.5	3.8	2.5	2.2	ST
SOD 15	7.8	5.0	2.8	3.0	ST

Диоды
Стабилитроны
Конденсаторы



Таблица 3.

Тип корпуса	L* (мм)	L** (мм)	W* (мм)	H** (мм)	B (мм)	Примечание
DO-215AA	4.3	6.2	3.6	2.3	2.05	JEDEC
DO-215AB	6.85	9.9	5.9	2.3	3.0	JEDEC
DO-215AC	4.3	6.1	2.6	2.4	1.4	JEDEC
DO-215BA	4.45	6.2	2.6	2.95	1.3	JEDEC
ESC	1.2	1.6	0.8	0.6	0.3	TOSHIBA
SOD-123	2.7	3.7	1.55	1.35	0.6	PHILIPS
SOD-123	1.7	2.5	1.25	1.0	0.3	PHILIPS
SSC	1.3	2.1	0.8	0.8	0.3	TOSHIBA

*- в зависимости от технологий, которыми обладает фирма, варьируется и нормируемые разбросы относительно базовых габаритов. Наиболее распространенные допуски: $\pm 0,05$ мм корпуса длиной до 1мм, например, 0402; $\pm 0,1$ мм- до 2 мм, например, SOD-232; $\pm 0,2$ мм – до 5 мм; $\pm 0,5$ мм – свыше 5 мм. Небольшие расхождения в цифрах у разных фирм обусловлены степенью точности перевода дюймов в мм, а так же указанием только min, max или номинального размера.

** - Корпуса с одним и тем же названием могут иметь разную высоту. Это обусловлено: для конденсаторов - величиной емкости и рабочим напряжением, для резисторов - рассеиваемой мощности, и т.д.

Диоды
Стабилитроны
Конденсаторы
Резисторы



Таблица 4.

Тип корпуса	L* (мм)	D* (мм)	F* (мм)	S* (мм)	Примечание
DO-213AA (SOD80)	3.5	1.65	0.48	0.03	JEDEC
DO-213AB (MELF)	5.0	2.52	0.48	0.03	JEDEC
DO-213AC	3.45	1.4	0.42	-	JEDEC
ERD03LL	1.6	1.0	0.2	0.05	PANASONIC
ERO21L	2.0	1.25	0.3	0.07	PANASONIC
ERSM	5.9	2.2	0.6	0.15	PANASONIC, ГОСТ P1-11
MELF	5.0	2.5	0.5	0.1	CENTS
SOD80 (miniMELF)	3.5	1.6	0.3	0.075	PHILIPS
SOD80C	3.6	1.52	0.3		PHILIPS
SOD87	3.5	2.05	0.3		PHILIPS

СКВОЗНАЯ НУМЕРАЦИЯ наиболее популярных корпусов SMD



Таблица 1.

JEDEC*	EIAJ*	PHILIPS SIEMENS CENTS* MAXIM	ROHM	SANYO	HITACHI	MOTOROLA	TOSHIBA KEC
TO-236	SC-59	SOT-346	SMD/T3		MPAK2	SC-59	S-MINI
TO-236AB		SOT/SOD-23	SSD/T3	CP		SOT-23	
TO-243AA	SC-62	SOT-89A	MPT3		UPAK		PW-MINI
TO-243AB		SOT-89B					
TO-252-3	SC-63		CPT3				
TO-253		SOT-143	SMD/T4			SOT-143	
TO-253		SOT-143R					
		SOD-123				SOD-123	
		SOD-323	UMD2				USC
		SOT-343					
		SOT-343R			CMPAK4		
		SOT-87					
	SC-70	SOT-323	UMD/T3	MCP	CMPAK	SO-323	USM
	SC-74		SMD/T6				SM6
	SC-74A		SMD/T5				SMV
	SC-74AA	SOT-416	EMD/T3				SSM
	SC-79	SOD-523	EMD2				
	SC-82		UMD/T4				
	SC-88	SOT-363	UMD/T6				US6
	SC-88A	SOT-353	UMD/T5				USV

* расшифровку аббревиатуры см. на стр. 155 и стр.158



Таблица 2.

Тип корпуса	PHILIPS MURATA AVX* VISHAY S+M*	TDK MALLORY SYFER KEMET VITRAMON BOURNS SINCERA YAGEO	SGS- THOMSON	PANASONIC	CTC	ROHM	SAMSUNG
0402	0402			10	06		05
0603	0603	0603	AN21	11	08	18	10
0805	0805	0805	AN12	12	12	21	21
1206	1206	1206	AN20	13		31	31
1210	1210	1210					
1218	1218						
1812	1812						43
2220	2220						

* расшифровку аббревиатуры см. на стр. 155



Таблица 3.

Тип корпуса	ST NOVER AVX* S+M	FUJITSU	HITACHI	NEC MATSUO SAMSUNG ELNA KEME NACC MALLORY	PNAS*	MOT* CS*	VISHAY	PHILIPS	ROHM
1608					E				
2012					D				
3216	A	A	A	A	Y		A		A
3216L									
3528	B	B1	B	B	X		B		B
3528L		B2	UB						
5832			UC						
5845			D		V				
6032	C	C	C	C	C		C		
73437343H	D	E	E	D	D		D		
DO-214AA	E		G	X					
DO-214AB						SMB	SMB		
DO-214AC						SMC	SMC		
DO-214BA						SMA	SMA	SOD-106	PMDS

* Расшифровка аббревиатур названий фирм см. на стр.155

** Наметилась тенденция, когда рядом с внутрифирменным обозначением корпуса указывается название этого корпуса по одному из стандартов – JEDEC или EIAJ

*** У разных фирм под одним и тем же названием могут корпуса отличающимися размерами; не указаны корпуса, которые внешне похожи на представленные, но имеют габаритные размеры, отличающиеся от стандартных, например, SOD15 фирмы SGS-Thomson.

В соответствии с ГОСТ2825-67 и требованием Публикации 63 ИЕС для номиналов резисторов и конденсаторов установлены следующие ряды значений сопротивлений и емкости.

E3	E6	E12	E24	E48	E96	E192
100	100	100	100	100	100	100
						101
					102	102
						104
				105	105	105
						106
					107	107
						109
			110	110	110	110
						111
					113	113
						114
				115	115	115
						117
					118	118
		120	120			120
				121	121	121
						123
					124	124
						126
				127	127	127
						129
			130		130	130
						132
				133	133	133
						135
					137	137
						138
				140	140	140
						142
					143	143
						145
				147	147	147
						149
	150	150	150		150	150
						152
				154	154	154
						156
					158	158
			160			160
				162	162	162
						164
					165	165
						167
				169	169	169
						172
					174	174
						176
				178	178	178
		180	180			180
					182	182
						184
				187	187	187
						189
					191	191
						193
				196	196	196
						198
			200		200	200
						203
				205	205	205
						208

E3	E6	E12	E24	E48	E96	E192
				316	316	316
						320
					324	324
						324
	330	330	330	332	332	332
						336
					340	340
						344
				348	348	348
						352
					357	357
			360			361
				365	365	365
						370
					374	374
						379
				383	383	383
						388
		390	390		392	392
						397
				402	402	402
						407
					412	412
						417
				422	422	422
						427
				430		432
					432	432
						437
				442	442	442
						448
					453	453
						459
				464	464	464
470	470	470	470			470
					475	475
						481
				487	487	487
						493
					499	499
						505
			510	511	511	511
						517
					523	523
						530
				536	536	536
						542
					549	549
						556
		560	560	562	562	562
						569
					576	576
						583
				590	590	590
						597
					604	604
						612
			620	619	619	619
						626
					634	634
						642
				649	649	649
						657

Продолжение

E3	E6	E12	E24	E48	E96	E192
					210	210
						213
				215	215	215
						218
220	220	220	220		221	221
						223
				226	226	226
						229
					232	232
						234
				237	237	237
			240			240
					243	243
						246
				249	249	249
						252
					255	255
						258
				261	261	261
						264
					267	267
		270	270			271
				274	274	274
						277
					280	280
						284
				287	287	287
						291
					294	294
						298
			300	301	301	301
						305
					309	309
						312

E3	E6	E12	E24	E48	E96	E192
					665	665
						673
	680	680	680	681	681	681
						690
					698	698
						706
				715	715	715
						723
					732	732
						741
			750	750	750	750
						759
					768	768
						777
				787	787	787
						796
					806	806
						816
		820	820	825	825	825
						835
					845	845
						856
				866	866	866
						876
					887	887
						898
			910	909	909	909
						920
					931	931
						942
				953	953	953
						965
					976	976
						988

РЕЗИСТОРЫ. ЦВЕТОВАЯ МАРКИРОВКА

В соответствии с ГОСТ175-72 и требованиям Публикации 62 ИЕС (Международной Электротехнической Комиссии) цветовая маркировка наносится в виде 4,5 или 6 цветных колец. Маркировочные кольца должны быть сдвинуты к одному из выводов или ширина кольца первого знака должна быть в два раза больше других, что на практике выдерживается не всегда.

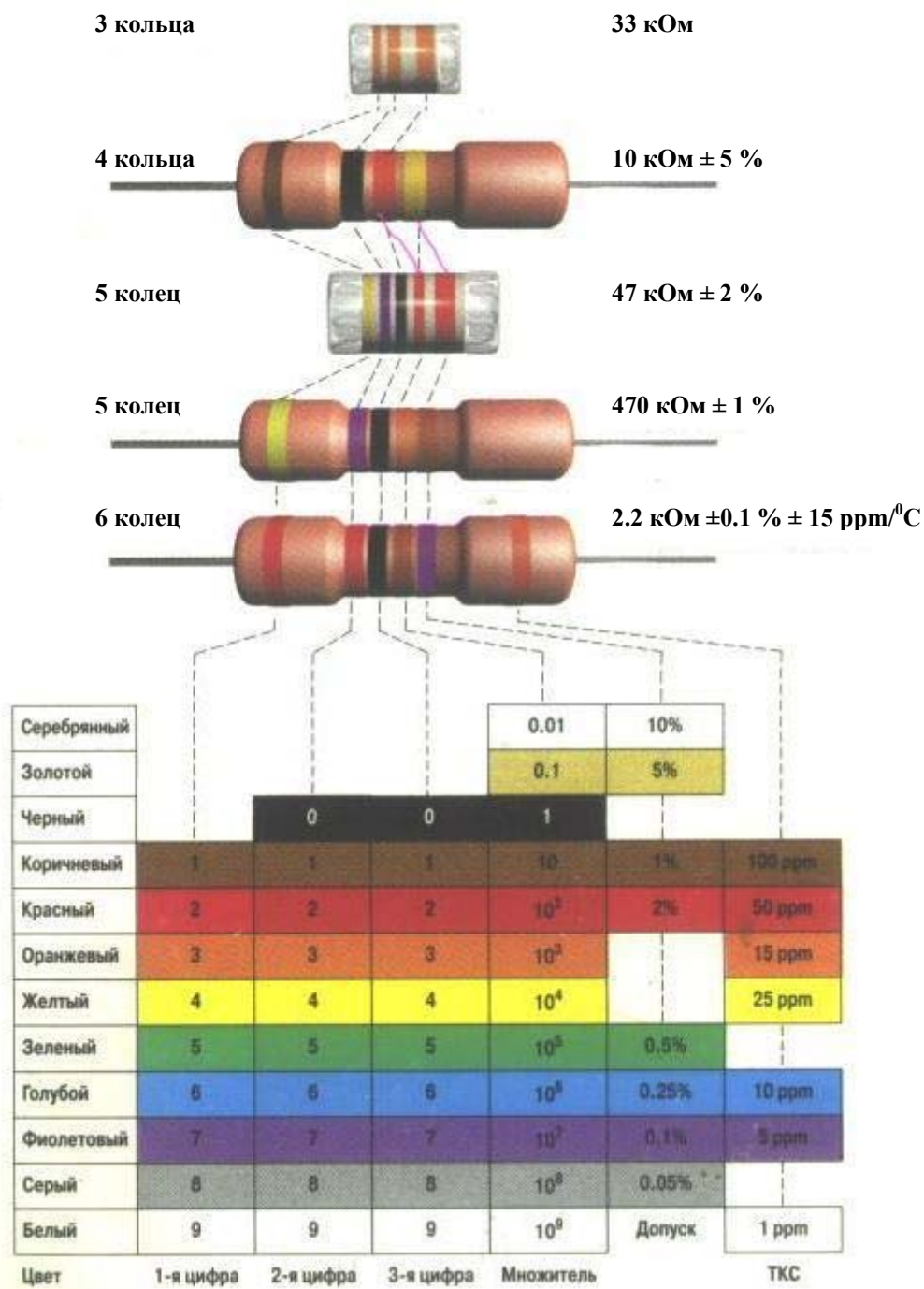

Примеры цветных кодировок различных фирм, отличающихся от вышеуказанной, приведены на стр. 11. Вместо цветных колец могут встречаться цветные точки. Принцип маркировки тот же.

РЕЗИСТОРЫ. ЦВЕТОВАЯ МАРКИРОВКА ФИРМЫ PHILIPS

Маркировка осуществляется 4,5 или 6-ю цветными полосами, несущими информацию о номинале, допуске и температурном коэффициенте сопротивления (ТКС) соответственно. Дополнительную информацию несет цвет корпуса резистора и взаимное расположение полос.

Металлопленочные резисторы – предохранители	NFR		12 кОм ± 5 %
Металлопленочные общего применения	SFR		12 кОм ± 5 %
Толстопленочные высокоомные, высоковольтные (>10 МОм; >1 кВ)	VR		2.7 МОм ± 5 %
Металлопленочные мощные (1 Вт/2 Вт)	PRO1/2		82 кОм ± 5 %
	MRS16		47 кОм ± 1 %
Металлопленочные прецизионные	MRS25		390 кОм ± 1 % ± 50 ppm/°C

Серебряный				0.01	10%	
Золотой				0.1	5%	
Черный		0	0	1		
Коричневый	1	1	1	10	1%	100 ppm
Красный	2	2	2	100	2%	50 ppm
Оранжевый	3	3	3	1k		15 ppm
Желтый	4	4	4	10k		25 ppm
Зеленый	5	5	5	100k	0.5%	ТКС
Голубой	6	6	6	1M	0.25%	
Фиолетовый	7	7	7	10M	0.1%	
Серый	8	8	8	100M	Допуск	
Белый	9	9	9	Множитель		
Цвет	1-я цифра	2-я цифра	3-я цифра			

РЕЗИСТОРЫ. НЕСТАНДАРТНАЯ ЦВЕТОВАЯ МАРКИРОВКА

Помимо стандартной цветовой маркировки, приведенной на стр. 10, многие фирмы применяют нестандартную – внутрифирменную маркировку. Нестандартная маркировка применяется для отличия, например, резисторов изготовленных по стандартам MIL от стандартов промышленного и бытового назначения, указывает на огнестойкость и т. д.

А. МАРКИРОВКА ФИРМЫ CORNING GLASS WORK (CGW)

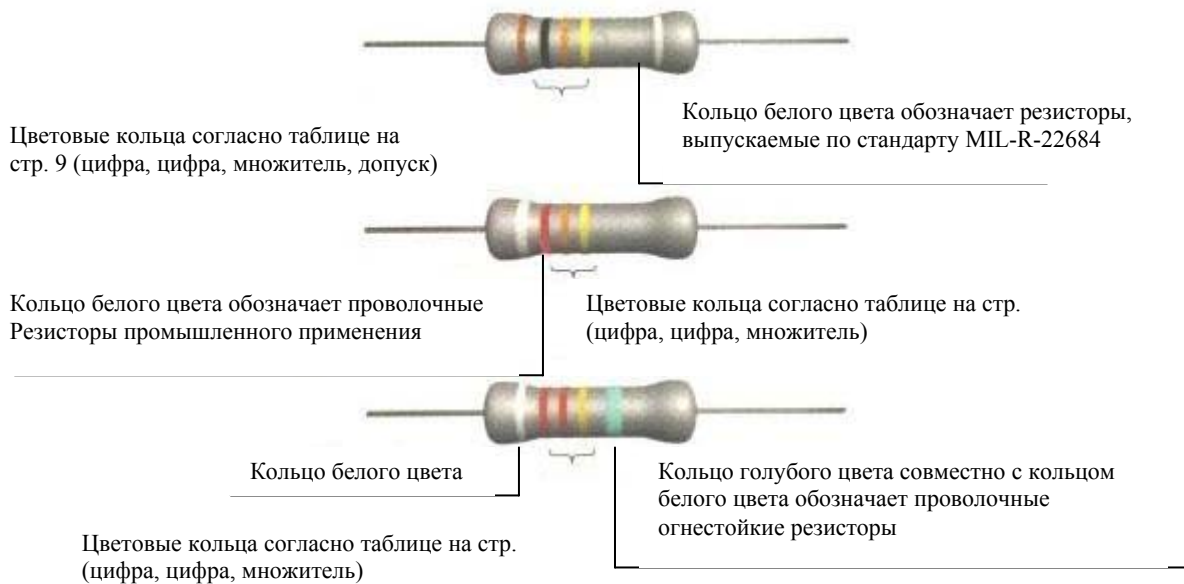

В. МАРКИРОВКА ФИРМЫ PANASONIC

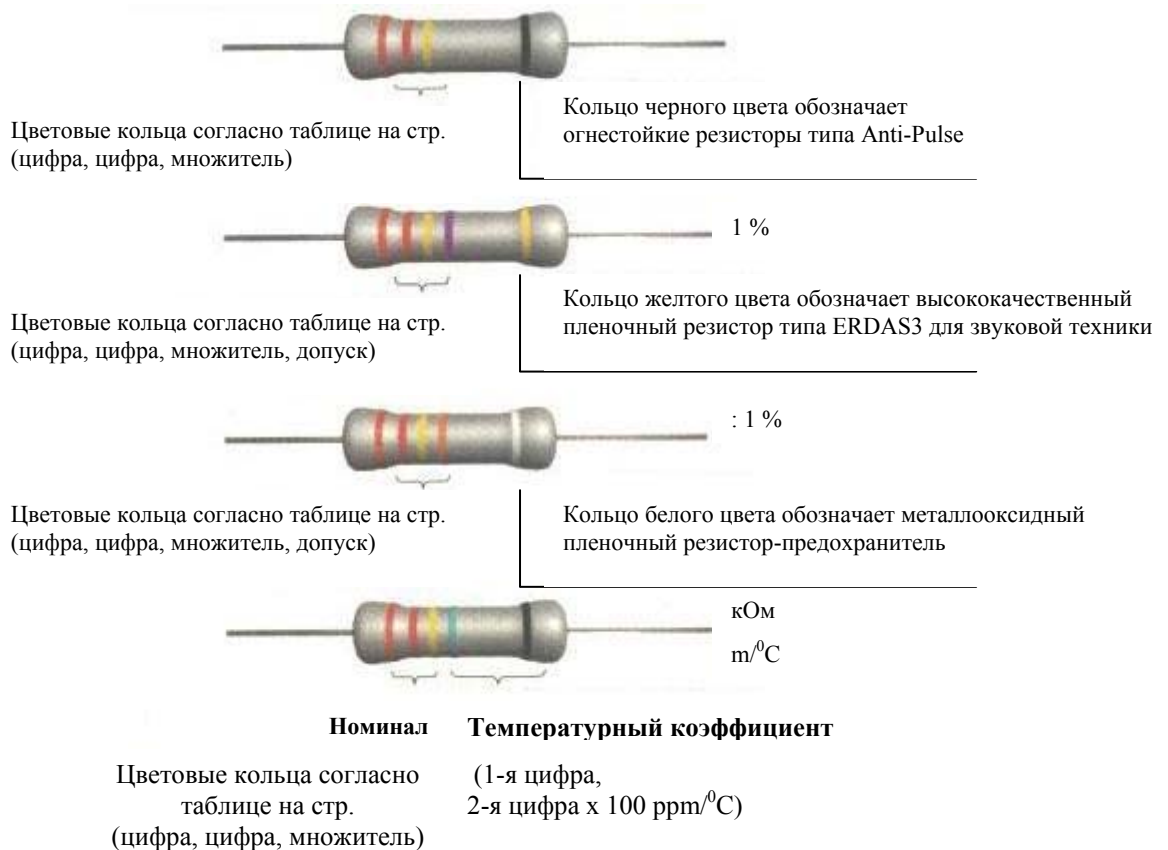

РЕЗИСТОРЫ. КОДОВАЯ МАРКИРОВКА

В соответствии с ГОСТ 11076-69 и требованиями Публикаций 62 и 115-2 ИЕС (МЭК) впервые 3 или 4 символа несут информацию о номинале резисторов, определяемого по базовому значению из рядов E3 ... E192, и множители. Последний символ несет информацию о допуске, т.е. классе точности резистора. Требования ГОСТ и ИЕС практически совпадают с еще одним стандартом BS1852 (British Standart).

НОМИНАЛ, [Ом]		ДОПУСК, [%]	
Базовое значение из рядов		E = ±0.001	
E3		L = ±0.002	
E6		R = ±0.005	
E12		P = ±0.01	
E24		U = ±0.02	
E48		A = ±0.05	
E96		B = ±0.1	
E192		C = ±0.25	
		D = ±0.5	
		F = ±1	
		G = ±2	
		J = ±5	
		K = ±10	
		M = ±20	
		N = ±30	
Множитель – как десятичная запятая		ТКС, [ppm/°C]	
R (E) = 1		T = ±10	
K (K) = 10 ³		E = ±25	
M (M) = 10 ⁶		C = ±50	
G (Г) = 10 ⁹		K = ±100	
T (Т) = 10 ¹²		J = ±150	
		L = ±200	
		D = ±200/-500	

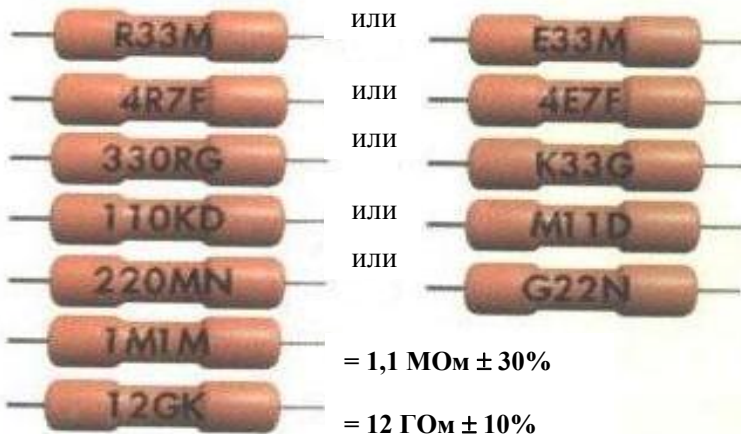

КОДОВАЯ МАРКИРОВКА ПРЕЦИЗИОННЫХ

Помимо строки, определяющей номинал и допуск резистора, может наноситься дополнительная кодированная информация о типе резистора, его номинальной мощности и дате выпуска. Пример:



Резистор типа P1-7
Мощность 2 Вт
Номинал 3.6 Ом $\pm 5\%$
Выпущен 2 февраля 1980 г.

КОДОВАЯ МАРКИРОВКА ПРЕЦИЗИОННЫХ ВЫСОКОСТАБИЛЬНЫХ РЕЗИСТОРОВ ФИРМЫ PANASONIC

ДОПУСК		НОМИНАЛ	
B = $\pm 0.1\%$		100 00 = 10 K	TKC
C = $\pm 0.25\%$		100 2	
D = $\pm 0.5\%$			E = ± 25 ppm / $^{\circ}\text{C}$
F = $\pm 1.0\%$			C = ± 50 ppm / $^{\circ}\text{C}$
ТИП РЕЗИСТОРА			
55		D = ± 100 ppm / $^{\circ}\text{C}$	
ТИП РЕЗИСТОРА		НОМИНАЛ	
ERN5B		1.00 кОм	
TKC		ДОПУСК	
± 5 ppm / $^{\circ}\text{C}$		$\pm 0.1\%$	

ПЕРЕМЫЧКИ И РЕЗИСТОРЫ С «НУЛЕВЫМ» СОПРОТИВЛЕНИЕМ

Многие фирмы выпускается в качестве плавких вставок или перемычек специальные провода – Jumper Wire – с нормированным сопротивлением и диаметром (0,6 мм, 0,8 мм) и резисторы с «нулевым» сопротивлением. Резисторы выполняются в стандартном цилиндрическом корпусе с гибкими выводами (Zero-Ohm) или в стандартном корпусе для поверхностного монтажа (Jumper Chip). Реальные значения сопротивления таких резисторов лежат в диапазоне единиц или десятков миллиом (– 0,005...0,05 Ом). В цилиндрических корпусах маркировка осуществляется черным кольцом посередине, в корпусах для поверхностного монтажа (0603, 0805, 1206...), обычно маркировка отсутствует, либо наносится код «000».

Zero-Ohm
(керамика-металл)
 $R \leq 13 \text{ мОм}$



$R \leq 13 \text{ мОм}$

Jumper-Chip
 $R \leq 50 \text{ мОм}$

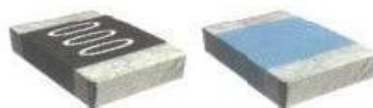

Jumper-Wire

0.6 мм

0.8 мм

РЕЗИСТОРЫ. КОДОВАЯ МАРКИРОВКА ФИРМЫ PHILIPS

Фирма PHILIPS кодирует номинал резисторов в соответствии с общепринятыми стандартами, т.е. первые две или три цифры указывают номинал в омах, а последняя – количество нулей (множитель). В зависимости от точности резистора номинал кодируется в виде 3 или 4-х символов. Отличия от стандартной кодировки могут заключаться в трактовке цифр 7, 8, 9 в последнем символе.

Буква R выполняет роль десятичной запятой, или, если она стоит в конце, то указывает на диапазон.

Последняя цифра	Номинал резистора
1	100...976 Ом
2	1...9.76 кОм
3	10...97.6 кОм
4	100...976 МОм
5	1...9.76 МОм
6	10...68 МОм
7	0,1...0,976 Ом
8	1...9,76 Ом
9	10...97,6 Ом

Символ	Номинал резистора
0	0 Ом
R	1...91 Ом



или



1008 или 108 = 1 Ом



или



3303 или 333 = 33 Ом



или



1006 или 106 = 10 МОм



R470 = 0.47 Ом

т. е. если на резисторе вы увидите код 107 – это 10 с семью нулями (100 МОм), а всего лишь 0.1 Ом

РЕЗИСТОРЫ. КОДОВАЯ МАРКИРОВКА ФИРМЫ BOURNS

А. Маркировка 3-мя цифрами.

Первые две цифры указывают значение в омах последняя – количество нулей. Распространяется на резисторы из ряда E-24, допуском 1 и 5%, типоразмеров 0603, 0805 и 1206.



$$103 = 10\ 000 = 10\ \text{кОм}$$

В. Маркировка 4-мя цифрами.

Первые три цифры указывают значения в омах последняя – количество нулей. Распространяется на резисторы из ряда E-96, допуском 1% , типоразмеров 0805 и 1206. Буква R играет роль десятичной запятой.



$$442R = 442\ 00 = 44.2\ \text{кОм}$$

С. Маркировка 3-мя символами.

Первые два символа – цифры, указывающие значение сопротивления в омах, взятые из нижеприведенной таблицы последний символ - буква, указывающая значение множителя:

$$S=10^{-2}; R=10^{-1}; B=10; C=10^2; D=10^3; E=10^4; F=10^5.$$

Распространяется на резисторы из ряда E-96, допуском 1%, типоразмером 0603.



$$10C = 124 \times 10^2 = 12.4\ \text{кОм}$$

Код	Значение	Код	Значение	Код	Значение	Код	Значение
01	100	25	178	49	316	73	562
02	102	26	182	50	324	74	576
03	105	27	187	51	332	75	590
04	107	28	191	52	340	76	604
05	110	29	196	53	348	77	619
06	113	30	200	54	357	78	634
07	115	31	205	55	365	79	649
08	118	32	210	56	374	80	665
09	121	33	215	57	383	81	681
10	124	34	221	58	392	82	698
11	127	35	226	59	402	83	715
12	130	36	232	60	412	84	732
13	133	37	237	61	422	85	750
14	137	38	243	62	432	86	768
15	140	39	249	63	442	87	787
16	143	40	255	64	453	88	806
17	147	41	261	65	464	89	825
18	150	42	267	66	475	90	845
19	154	43	274	67	487	91	866
20	158	44	280	68	499	92	887
21	162	45	287	69	511	93	909
22	165	46	294	70	523	94	931
23	169	47	301	71	536	95	953
24	174	48	309	72	549	96	976

Примечание. Маркировки А и В – стандартные, маркировка С – внутрифирменная.

КОНДЕНСАТОРЫ. ДОПУСКИ

В соответствии с требованиями Публикаций 62 и 115-2 IЕС (МЭК) для конденсаторов установлены следующие допуски и их кодировка.

Допуск, %	Буквенное обозначение	Цвет
± 0.1 пФ*	B(Ж)	
± 0.25 пФ*	C(Y)	● ОРАНЖЕВЫЙ
± 0.5 пФ*	D(D)	● ЖЕЛТЫЙ
± 1.0 пФ*	F(P)	● КОРИЧНЕВЫЙ
± 2.0 пФ*	G(J)	● КРАСНЫЙ
± 5.0 пФ*	J(I)	● ЗЕЛЕНый
± 10	K(C)	○ БЕЛый
± 20	M(B)	● ЧЕРНЫЙ
± 30	N(Ф)	
- 10...+30	Q(O)	
- 10...+50	T(Э)	
- 10...+100	Y(Ю)	
- 20...+50	S(Б)	● ФИОЛЕТОВый
- 20...+80	Z(A)	● СЕРый

* Для конденсаторов емкостью < 10 пФ.

** Для конденсаторов с рабочим напряжением до 63 В.

Пересчет % (d) в фарады (D):

$$\Delta = \frac{\delta \times C}{100\%}$$

Пример: Реальное значение конденсатора с маркировкой 221J (0.22нФ \pm 5%) лежит в диапазоне:

$$C = 0.22 \text{ нФ} \pm \Delta = (0.22 \pm 0.01) \text{ нФ},$$

где

$$\Delta = (0.22 \times 10^{-9} [\text{Ф}] \times 5) \times 0.01 = 0.01 \text{ нФ}$$

Или соответственно от 0.21 до 0.23 нФ.

КОНДЕНСАТОРЫ. ТЕМПЕРАТУРНЫЙ КОЭФФИЦИЕНТ ЕМКОСТИ (ТКЕ).

КОНДЕНСАТОРЫ С НЕНОМИРУЕМЫМ ТКЕ.

Группа ТКЕ	Допуск при $-60..+85\text{ C}^\circ$ [%]	Буквенный код	Цвет
H10	± 10	B	● оранжевый + ● черный
H20	± 20	Z	● оранжевый + ● красный
H30	± 30	D	● оранжевый + ● зеленый
H50	± 50	X	● оранжевый + ● голубой
H70	± 70	E	● оранжевый + ● фиолетовый
H90	± 90	F	● оранжевый + ○ белый

*- современная цветовая кодировка. Цветные полосы или точки. Второй цвет может быть представлен цветом корпуса.

КОНДЕНСАТОРЫ С ЛИНЕЙНОЙ ЗАВИСИМОСТЬЮ ОТ ТЕМПЕРАТУРЫ

Обозначение ГОСТ	Обозначение международное	ТКЕ [ppm/C]*	Буквенный код	Цвет**
П100	P100	100(+130...-49)	A	● Красный + ● фиолетовый
П33		33	N	● Серый
МПО	NP0	0(+30...-75)	C	● Черный
М33	N030	-33(+30...-80)	H	● Коричневый
М75	N080	-75(+30...-80)	L	● Красный
М150	N150	-150(+30...-105)	P	● Оранжевый
М220	N220	-220(+30...-120)	R	● Желтый
М330	N330	-330(+60...-180)	S	● Зеленый
М470	N470	-470(+60...-210)	T	● Голубой
М750	N750	-750(+120...-330)	U	● Фиолетовый
М1500	N1500	-500(-250...-670)	V	● Оранжевый + ● оранжевый
М2200	N2200	-2200	K	● Желтый + ● оранжевый

*- в скобках приведен реальный разброс для импортных конденсаторов в диапазоне температур $-55...+85\text{ C}^\circ$

** - современная цветовая кодировка в соответствии с EIA. Цветные полосы или точки. Второй цвет может быть представлен цветом корпуса.

КОНДЕНСАТОРЫ С НЕЛИНЕЙНОЙ ЗАВИСИМОСТЬЮ ОТ ТЕМПЕРАТУРЫ

Группа ТКЕ*	Допуск [%]	Температура** [°C]	Буквенный код ***	Цвет
Y5F	± 7.5	-30...+85		
Y5P	± 10	-30...+85		● серебряный
Y5R		-30...+85	R	● серый
Y5S	± 22	-30...+85	S	● коричневый
Y5U	$\pm 22 \dots -56$	-30...+85	A	
Y5V(2F)	$\pm 22 \dots -82$	-30...+85		
X5F	± 7.5	-55...+85		
X5P	± 10	-55...+85		
X5S	± 22	-55...+85		
X5U	$\pm 22 \dots -56$	-55...+85		● синий
X5V	$\pm 22 \dots -82$	-55...+85		
X7R(2R)	± 15	-55...+125		
Z5F	± 7.5	-10...+85	B	
Z5P	± 10	-10...+85	C	
Z5S	± 22	-10...+85		
Z5U(2E)	$\pm 22 \dots -56$	-10...+85	E	
Z5V	$\pm 22 \dots -82$	-10...+85	F	● зеленый
SLO(GP)	+150...-1500	-55...+150	NiL	○ белый

*- Обозначения приведены в соответствии со стандартом EIA, в скобках (IEC)

** - в зависимости от технологий, которыми обладает фирма диапазон может быть другим.

Например, фирма PHILIPS для группы Y5P нормирует $-55 \dots +125$ °C.

*** - в соответствии с EIA. Некоторые фирмы, например, Panasonic пользуется другой кодировкой.

КОНДЕНСАТОРЫ. ЦВЕТОВАЯ МАРКИРОВКА

На практике для цветового кодирования постоянных конденсаторов используются несколько методик маркировки:

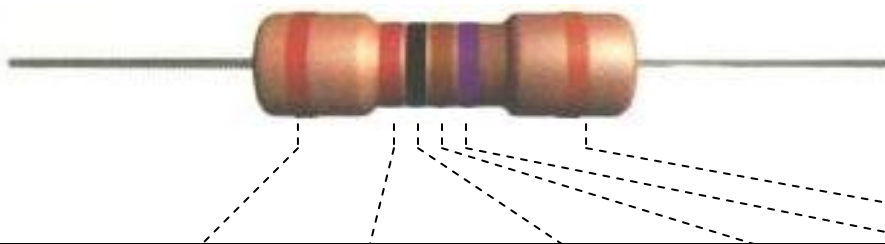

Метки (полосы, точки, кольца)	1	2	3	4	5	6
3 метки*	1-я цифра	2-я цифра	Множитель	-	-	-
4 метки	1-я цифра	2-я цифра	Множитель	Допуск	-	-
4 метки	1-я цифра	2-я цифра	Множитель	Напряжение	-	-
4 метки	1 и 2-я цифры	Множитель	Допуск	Напряжение	-	-
5 метки	1-я цифра	2-я цифра	Множитель	Допуск	Напряжение	-
5 метки**	1-я цифра	2-я цифра	Множитель	Допуск	ТКЕ	-
6 метки	1-я цифра	2-я цифра	3-я цифра	Множитель	Допуск	ТКЕ

*- допуск 20% ; возможно сочетание двух колец и точки, указывающей на множитель

** - цвет корпуса указывает на значение рабочего напряжения

Вывод ⊕ может иметь больший размер диаметр.

500 нФ

330 мкФ
20 В

(определяется по
положению точки)

Черный			0	1	10	
Коричневый	1	1	10			
Красный	2	2	100			
Оранжевый	3	3				
Желтый	4	4				6.3
Зеленый	5	5				16
Голубой	6	6				20
Фиолетовый	7	7				
Серый	8	8	0.01			25
Белый	9	9	0.1			3
Розовый						35

Цвет

1-я цифра 2-я цифра

Множитель

мкФ

Напряжение

КОНДЕНСАТОРЫ. ЦВЕТОВАЯ МАРКИРОВКА (ПРОДОЛЖЕНИЕ)

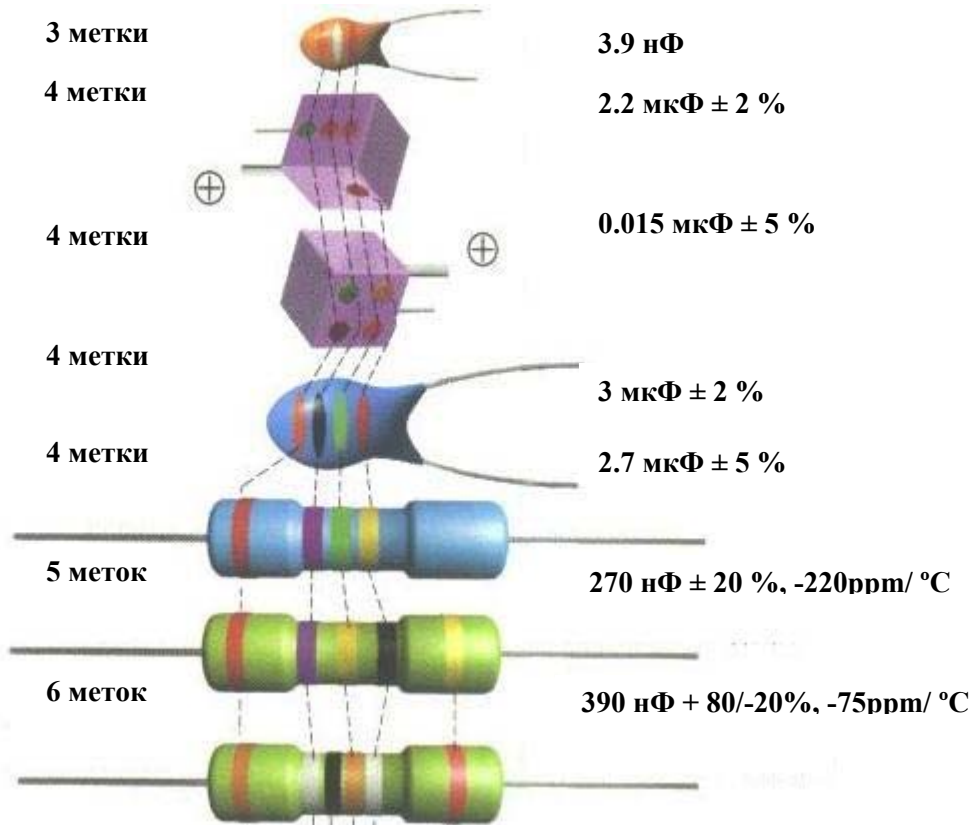

Серебряный				0.01	10%	Y5P
Золотой				0.1	5%	
Черный		0	0	1	20%*	NPO
Коричневый	1	1	1	10	1%**	Y5S, N33
Красный	2	2	2	100	2%	N75
Оранжевый	3	3	3	10 ³		N150
Желтый	4	4	4	10 ⁴		N220
Зеленый	5	5	5	10 ⁵		N330
Голубой	6	6	6	10 ⁶		N470
Фиолетовый	7	7	7	10 ⁷		N750
Серый	8	8	8	10 ⁸	30%	Y5R
Белый	9	9	9	Множитель	+80/-20%	SL

Цвет **1-я цифра** **2-я цифра** **3-я цифра** **Допуск** **ТКЕ**

пФ

* для ёмкостей меньше 10 пФ допуск ± 2.0 пФ

** для ёмкостей меньше 10 пФ допуск ± 0.1 пФ

КОНДЕНСАТОРЫ. ЦВЕТОВАЯ МАРКИРОВКА (ПРОДОЛЖЕНИЕ)

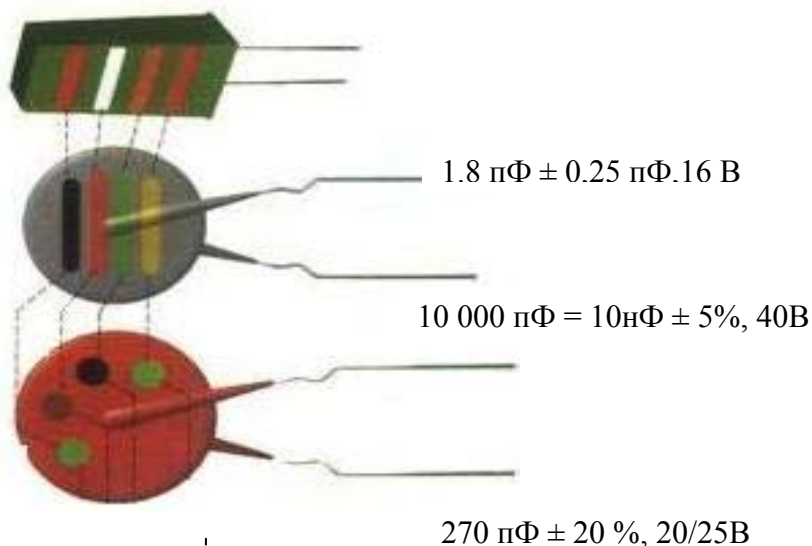

Черный	10	1	20%	4
Коричневый	12	10	1%	6.3
Красный	15	100	2%	10
Оранжевый	18	10^3	0.25 пФ	16
Желтый	22	10^4	0.5 пФ	40
Зеленый	27	10^5	5%	20/25
Голубой	33	10^6	1%	30/32
Фиолетовый	39	10^7	-20...+50%	
Серый	47	0.01	-20...+80%	3.2
Белый	56	0.1	10%	63
Серебряный	68			2.5
Золотой	82		5%	1.6

Цвет
1-я и 2-я
Множитель
Допуск
Напряжение
цифры

КОНДЕНСАТОРЫ. ЦВЕТОВАЯ МАРКИРОВКА (ПРОДОЛЖЕНИЕ)

Для маркировки пленочных конденсаторов используют 5 цветных полос или точек. Первые три кодируют значение емкости, четвертая – допуск, пятая – номинальное рабочее напряжение.

Номинальная емкость, мкФ	Допуск	Напряжение
0.01	±10%	250 В
0.015		
0.02		
0.03		
0.04		
0.06		
0.10		
0.15		
0.22		
0.33		
0.47	±20%	400 В
0.68		
1.0		
1.5		
2.2		
3.3		
4.7		
6.8		

1 полоса 2 полоса 3 полоса 4 полоса 5 полоса

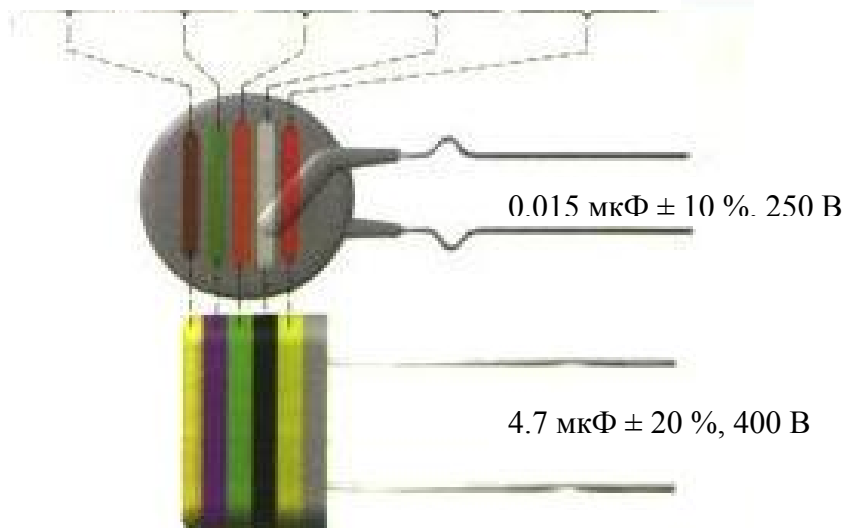

КОНДЕНСАТОРЫ. КОДОВАЯ МАРКИРОВКА

В соответствии со стандартами IЕС на практике применяется четыре способа кодировки номинальной емкости.

А. КОДИРОВКА 3-МЯ ЦИФРАМИ

Первые две цифры указывают значение емкости в пикофарадах (пФ), последняя- количество нулей. Когда конденсатор имеет емкость менее 10пФ, то последняя цифра может быть «9». При емкостях меньше 1.0 пФ первая цифра «0». Буква R используется в качестве десятичной запятой. Например, код 010 равен 1.0 пФ, код 0R5- 0.5 пФ.

Код	Пикофарады, (пФ, pF)	Нанофарады, (нФ, nF)	Микрофарады,(мкФ, μF)
109	1.0	0.001	0.00001
159	1.5	0.0015	0.00001
229	2.2	0.0022	0.00001
339	3.3	0.0033	0.00001
479	4.7	0.0047	0.00001
689	6.8	0.0068	0.00001
100*	10	0.01	0.0001
150	15	0.015	0.000015
220	22	0.022	0.000022
330	33	0.033	0.000033
470	47	0.047	0.000047
680	68	0.068	0.000068
101	100	0.1	0.0001
151	150	0.15	0.00015
221	220	0.22	0.00022
331	330	0.33	0.00033
471	470	0.47	0.00047
681	680	0.68	0.00068
102	1000	1.0	0.001
152	1500	1.5	0.0015
222	2200	2.2	0.0022
332	3300	3.3	0.0033
472	4700	4.7	0.0047
682	6800	6.8	0.0068
103	10000	10	0.1
153	15000	15	0.15
223	22000	22	0.022
333	33000	33	0.033
473	47000	47	0.047
683	68000	68	0.068
104	10000	100	0.1
154	150000	150	0.15
224	220000	220	0.22
334	330000	330	0.33
474	470000	470	0.47
684	680000	680	0.68
105	1000000	1000	1.0

*- Иногда последний ноль не указывают.

В. КОДИРОВКА 4-МЯ ЦИФРАМИ

Возможны варианты кодирования 4-х значным числом. Но и в этом случае последняя цифра указывает количество нулей, а первые три-емкость в пикофарадах (pF).

Код	Пикофарады, (пФ, pF)	Нанофарады, (нФ, nF)	Микрофарады,(мкФ, μF)
1622	16200	16.2	0.0162
4753	475000	475	0.475

ПРИМЕРЫ:

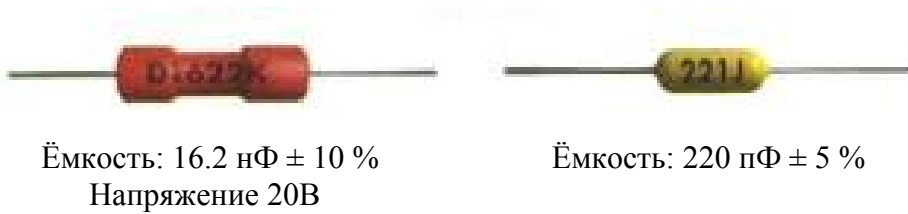
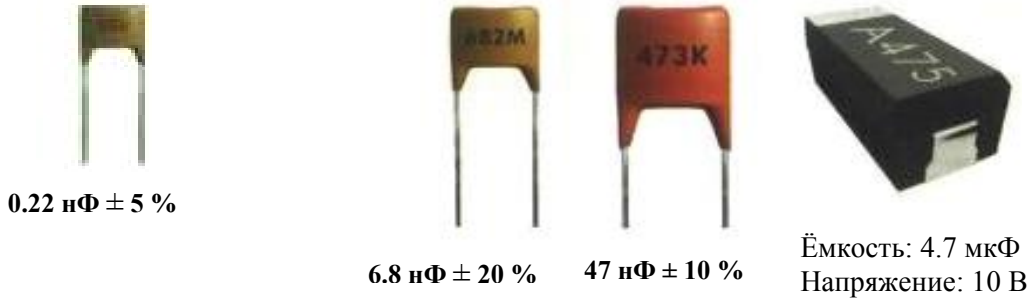

C. МАРКИРОВКА ЁМКОСТИ В МИКРОФАРАДАХ

Вместо десятичной точки может ставиться буква R.

Код	Ёмкость
R1	0.1 мкФ
R47	0.47 мкФ
1	1.0 мкФ
4R7	4.7 мкФ
10	10 мкФ
100	100 мкФ



D. СМЕШАННАЯ БУКВЕННО-ЦИФРОВАЯ МАРКИРОВКА ЁМКОСТИ, ДОПУСКА, ТКЕ, РАБОЧЕГО НАПРЯЖЕНИЯ

В отличие от первых трех параметров, которые маркируются в соответствии со стандартами, рабочее напряжение у разных фирм имеет различную буквенно-цифровую маркировку.

Код	Ёмкость
p10	0.1 пФ
1p5	1.5 пФ
332p	332 пФ
1п0 или 1n0	1.0 нФ
15п или 15n	15 нФ
33п2 или 33n2	33.2 нФ
590п или 590n	290 нФ
µ15	0.15 мкФ
1µ5	1.5 мкФ
33µ2	33.2 мкФ
330µ	330 мкФ
1m0	1мФ или 1000 мкФ
10m	10 мФ

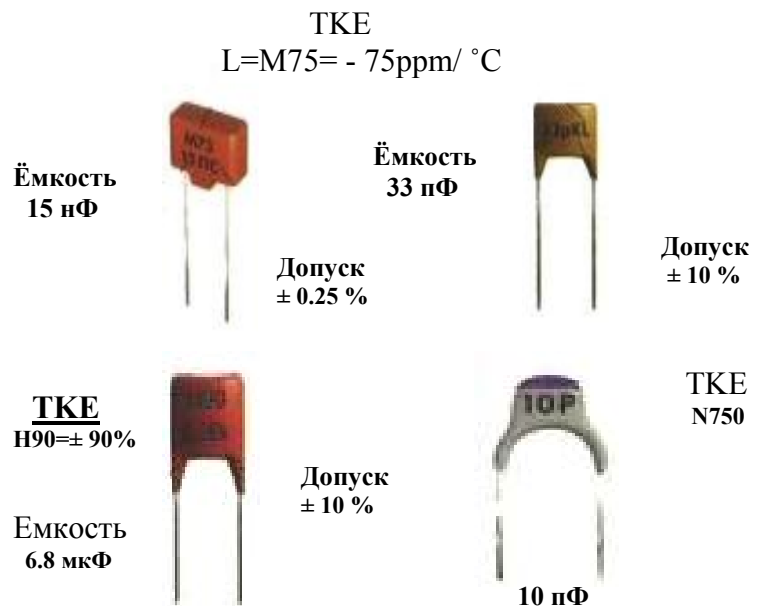

КОНДЕНСАТОРЫ. ЦВЕТОВАЯ МАРКИРОВКА ЭЛЕКТРОЛИТИЧЕСКИХ КОНДЕНСАТОРОВ ДЛЯ ПОВЕРХНОСТНОГО МОНТАЖА (SMD)

Приведенные ниже принципы кодовой маркировки применяются такими известными фирмами как PANASONIC, HITACHI и др. Различают три основных способа кодирования.

А. Код содержит два или три знака (буквы или цифры), обозначающие рабочее напряжение и номинальную емкость. Причем буквы обозначают напряжение и емкость, а цифра указывает множитель. В случае двухзначного обозначения не указывается код рабочего напряжения.

РАБОЧЕЕ НАПРЯЖЕНИЕ

G – 4 В
J – 6.3 или 7 В
A – 10 В
C – 16 В
D – 20 В
E – 25 В
V – 35 В

* - перед буквами может ставиться цифра, указывающая на диапазон:

0 - для напряжений до 10 В

1 – для напряжения до 100 В

2 – для напряжения до 1000 В.

Например, 0E – 2.5 В; 1E – 25 В; 2E

– 250 В

ЁМКОСТЬ

A – 1.0 пФ
E – 1.5 пФ
J – 2.2 пФ
N – 3.3 пФ
S – 4.7 пФ
W – 6.8 пФ

МНОЖИТЕЛЬ

5 – 10^5

6 – 10^6

7 – 10^7



ПРИМЕРЫ МАРКИРОВКИ

Код	Емкость (мкФ)	Напряжение (В)
A6	1.0	16/35
A7	10	10
AA7	10	10
AE7	15	10
AJ6	2.2	10
AJ7	22	10
AN6	3.3	10
AN7	33	10
AS6	4.7	10
AW6	6.8	10
CA7	10	16
CE6	1.5	16
CE7	15	16
CJ6	2.2	16
CN6	3.3	16
CS6	4.7	16
CW6	6.8	16
GN7	33	4
GS6	4.7	4
GS7	47	4
GW6	6.8	4
GW7	68	4
J6	2.2	6.3/7/20
JA7	10	6.3/7
JE7	15	6.3/7
JJ7	22	6.3/7
JN6	3.3	6.3/7
JN7	33	6.3/7
JS6	4.7	6.3/7

Код	Емкость (мкФ)	Напряжение (В)
DA6	1.0	20
DA7	10	20
DE6	1.5	20
DJ6	2.2	20
DN6	3.3	20
DS6	4.7	20
DW6	6.8	20
E6	1.5	10/25
EA6	1.0	25
EE6	1.5	25
EJ6	2.2	25
EN6	3.3	25
ES6	4.7	25
EW5	0.68	25
GA7	10	4
GE7	15	4
GJ7	22	4
JS7	47	6.3/7
JW6	6.8	6.3/7
N5	0.33	35
N6	3.3	4/16
S5	0.47	25/35
VA6	1.0	35
VE6	1.5	35
VJ6	2.2	35
VN6	3.3	35
VS5	0.47	35
VW5	0.68	35
W5	0.68	20/35



1.0 пФ x 10^7 мкФ
4 В



10 мкФ x 10 В



2.2 пФ x 10^6 = 2.2 мкФ
20 В

В. Код содержит четыре знака (буквы и цифры), обозначающие номинальную емкость и рабочее напряжение. Буква, стоящая вначале, обозначает рабочее напряжение, последующие знаки – емкость в пикофарадах (пФ), а последняя цифра – количество нулей. Возможны 2 варианта кодировки емкости: а) первые две цифры указывают номинал в пФ, третья – количество нулей; б) емкость указывают в микрофарадах, знак μ выполняет функцию десятичной запятой. Ниже приведены примеры маркировки конденсаторов емкостью 4,7 мкФ и рабочим напряжением 10 В.

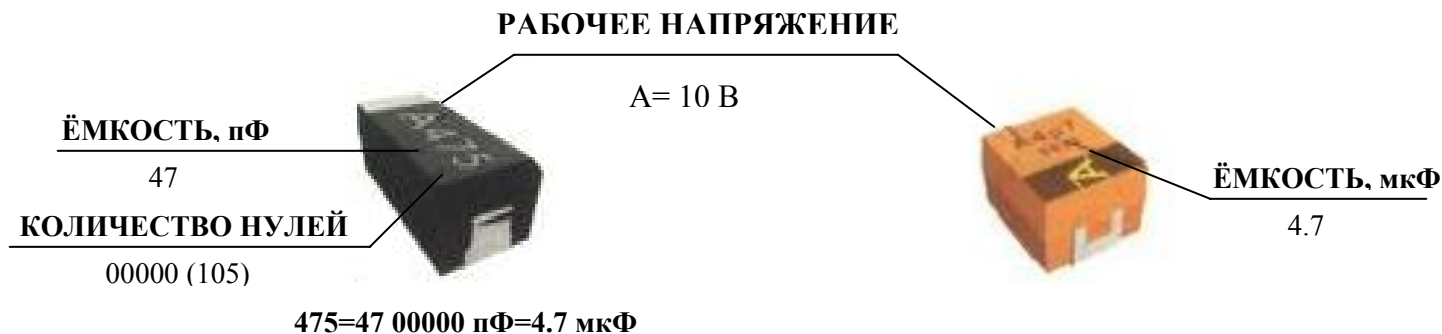

С. Если величина корпуса позволяет, то код располагается в две строки: на верхней строке указывается номинал емкости, на второй строке – рабочее напряжение. Емкость может указываться непосредственно в микрофарадах (мкФ) или в пикофарадах (пФ) с указанием количества нулей (см. способ В). Например, первая строка – 15, вторая строка 35V означает, что конденсатор имеет емкость 15 мкФ и рабочее напряжение 35 В.

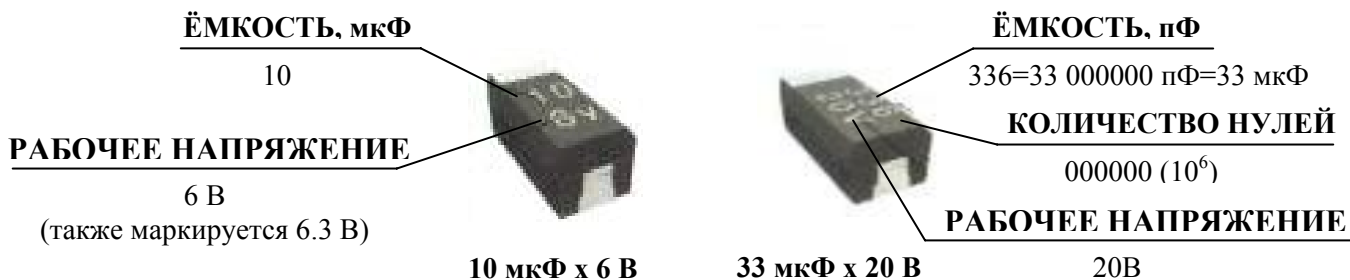

МАРКИРОВКА ПЛЕНОЧНЫХ КОНДЕНСАТОРОВ ДЛЯ ПОВЕРХНОСТНОГО МОНТАЖА ФИРМЫ NITASNI

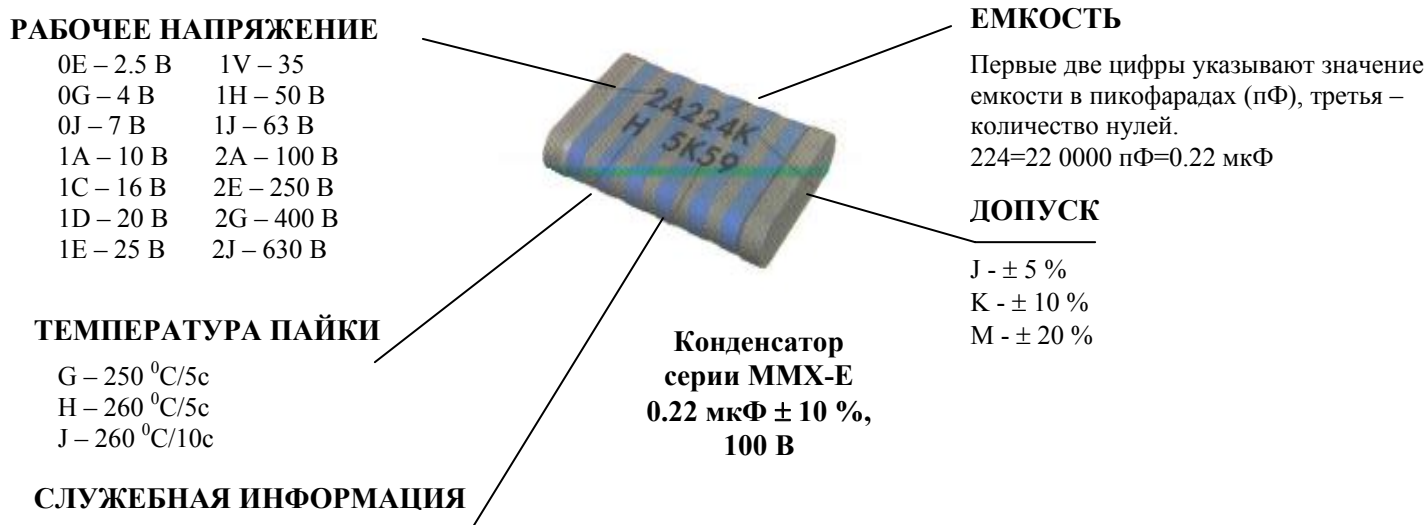

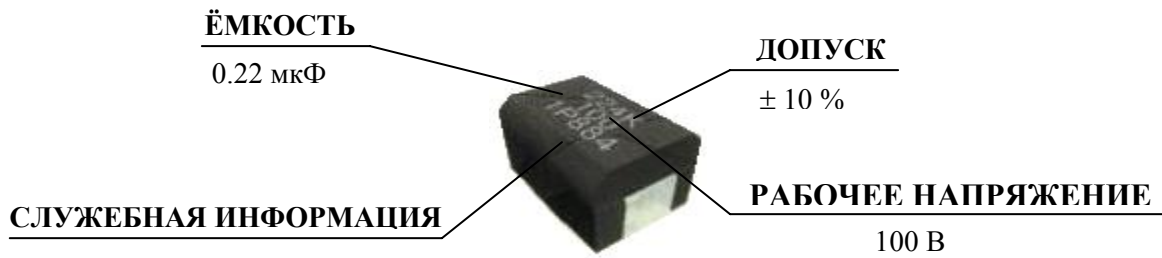

ИНДУКТИВНОСТИ. ЦВЕТОВАЯ МАРКИРОВКА

В соответствии с Публикациями IЕС 62 для индуктивностей кодируется номинальное значение индуктивности и допуск, т. е. Допускаемое отклонение от указанного номинала. Наиболее часто применяется кодировка 4 или 3 цветными кольцами или точками. Первые две метки указывают на значение номинальной индуктивности в микрогенри (мкГн, μH), третья метка – множитель, четвертая – допуск. В случае кодирования 3 метками подразумевается допуск 20%. Цветное кольцо, обозначающее первую цифру номинала может быть шире, чем все остальное.

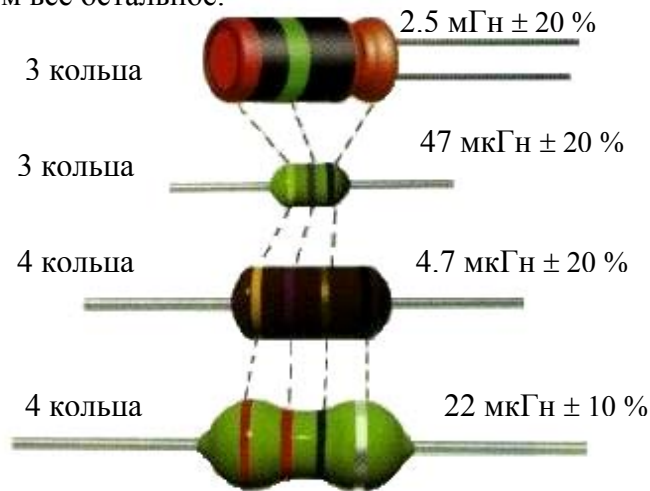

Серебряный			0.01	10%
Золотой			0.1	5%
Черный		0	1	20%
Коричневый	1	1	10	Допуск
Красный	2	2	100	
Оранжевый	3	3	1000	
Желтый	4	4		Множитель
Зеленый	5	5		
Голубой	6	6		
Фиолетовый	7	7		
Серый	8	8		
Белый	9	9		
	1-я цифра	2-я цифра		

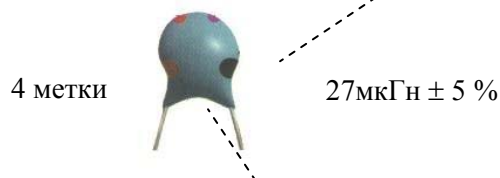

ИНДУКТИВНОСТИ. КОДОВАЯ МАРКИРОВКА

Обычно для индуктивностей кодируется номинальное значение индуктивности и допуск, т.е. допускаемое отклонение от указанного номинала. Номинальное значение кодируется цифрами, а допуск – буквами. Применяется два вида кодирования.

А. Первые две цифры указывают значение в микрогенри (мкГн, μH), последняя – количество нулей. Следующая за цифрами буква указывает на допуск. Например, код 101J обозначает $100 \text{ мкГн} \pm 5\%$. Исключение является случаи, когда индуктивность меньше 10 мкГн . В таких случаях роль десятичной запятой выполняют буквы R или N – для индуктивностей меньше 1 мкГн . В случаях, когда буква не указывается – допуск 20% .

ДОПУСК: D = $\pm 0.3 \text{ нГн}$ J = $\pm 5\%$ K = $\pm 10\%$ M = $\pm 20\%$

ПРИМЕРЫ ОБОЗНАЧЕНИЙ:

2N2D – $2.2 \text{ нГн} \pm 0.3 \text{ нГн}$	1R0K – $1.2 \text{ мкГн} \pm 10\%$	1470K – $47 \text{ мкГн} \pm 10\%$
22N – 22 нГн	2R2K – $2.2 \text{ мкГн} \pm 10\%$	680K – $68 \text{ мкГн} \pm 10\%$
R10M – $0.10 \text{ мкГн} \pm 20\%$	3R0K – $3.3 \text{ мкГн} \pm 10\%$	101K – $100 \text{ мкГн} \pm 10\%$
R15M – $0.15 \text{ мкГн} \pm 20\%$	4R7K – $4.7 \text{ мкГн} \pm 10\%$	151K – $150 \text{ мкГн} \pm 10\%$
R22M – $0.22 \text{ мкГн} \pm 20\%$	6R8K – $6.8 \text{ мкГн} \pm 10\%$	221K – $220 \text{ мкГн} \pm 10\%$
R33M – $0.33 \text{ мкГн} \pm 20\%$	100K – $10 \text{ мкГн} \pm 10\%$	331K – $330 \text{ мкГн} \pm 10\%$
R47M – $0.47 \text{ мкГн} \pm 20\%$	150K – $15 \text{ мкГн} \pm 10\%$	471J – $470 \text{ мкГн} \pm 5\%$
R68M – $0.68 \text{ мкГн} \pm 20\%$	220K – $22 \text{ мкГн} \pm 10\%$	681J – $680 \text{ мкГн} \pm 5\%$
1R0K – $1.2 \text{ мкГн} \pm 10\%$	330K – $33 \text{ мкГн} \pm 10\%$	102 – 1000 мкГн

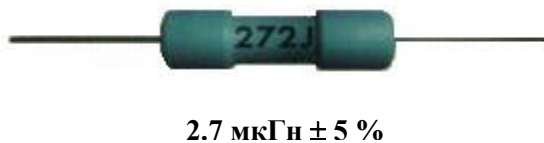

В. Индуктивности маркируются непосредственно в микрогенри (мкГн, μH). В таких случаях маркировка 680K будет означать не $68 \text{ мкГн} \pm 10\%$, как в случае А, а $680 \text{ мкГн} \pm 10\%$



ТРАНЗИСТОРЫ. КОДОВАЯ МАРКИРОВКА. КОРПУС КТ-26 (ТО-92)

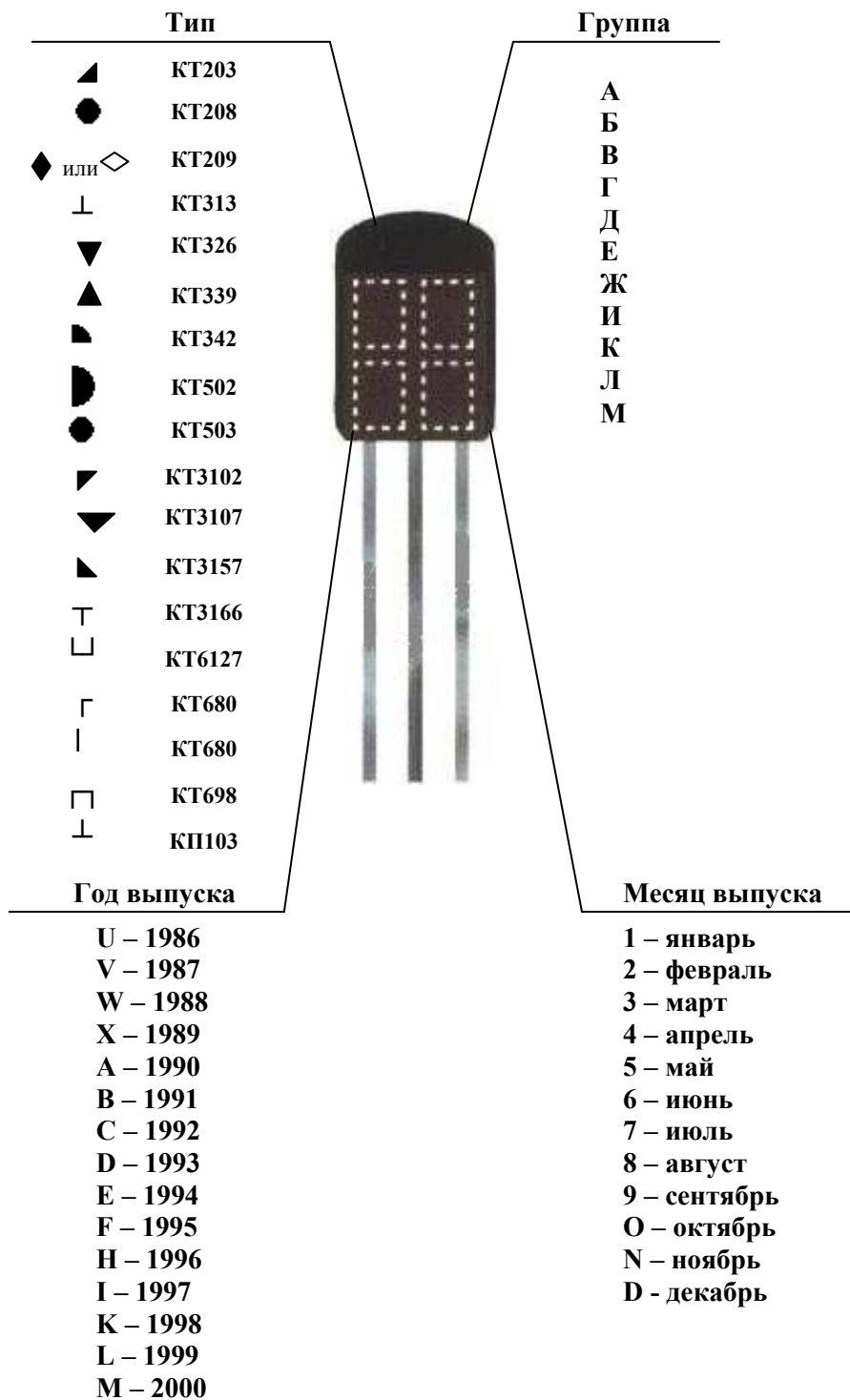

**ТРАНЗИСТОРЫ. КОДОВАЯ МАРКИРОВКА.
КОРПУС КТ-26 (ТО-92) (продолжение)**

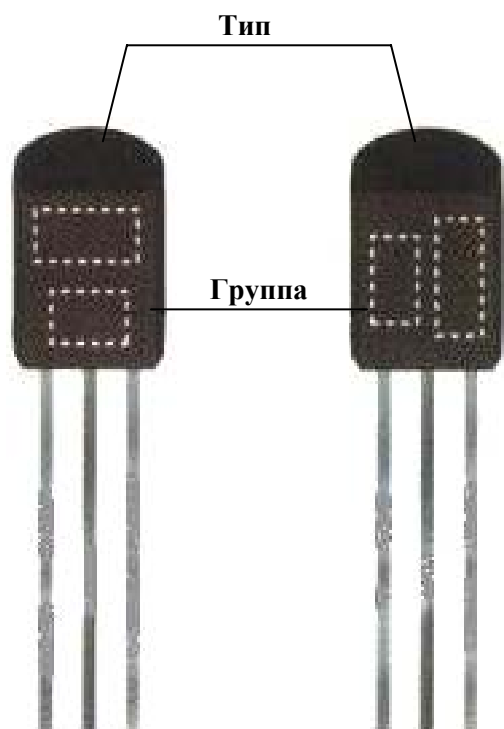

**КТ208А1
КТ306АМ
КТ325БМ
КТ337А
КТ342Б
КТ350А
КТ373Б
КТ375А
КТ645А**

**КТ357В
КТ399ГМ
КТ3102Г, Е
КТ3107Б**

ПРИМЕРЫ СТАНДАРТНЫХ КОДОВЫХ МАРКИРОВОК



KT326AM 11.1994 г. KT3107ДМ 04.1993 г. KT503E 10.1992 г. KT681A 09.1991 г. KT502Г 12.1993 г. KT3157A 04.1993 г. KT3166A 04.1993 г. KT326 05.1998 г. KT3157A 09.1991 г.

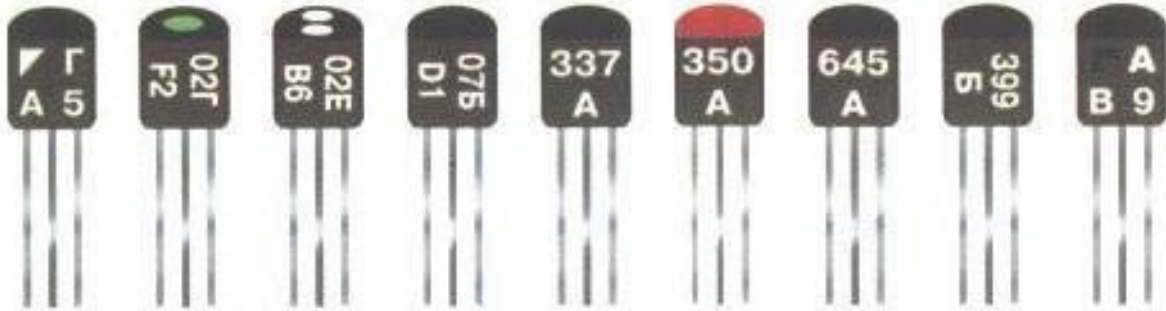

KT3102ГМ KT3102ГМ KT3102ЕМ KT3107Б KT337A KT350A KT645A KT399A KT680A



KT209K KT209K KT399 KT357B KT373B KT375A KT503B KT681A

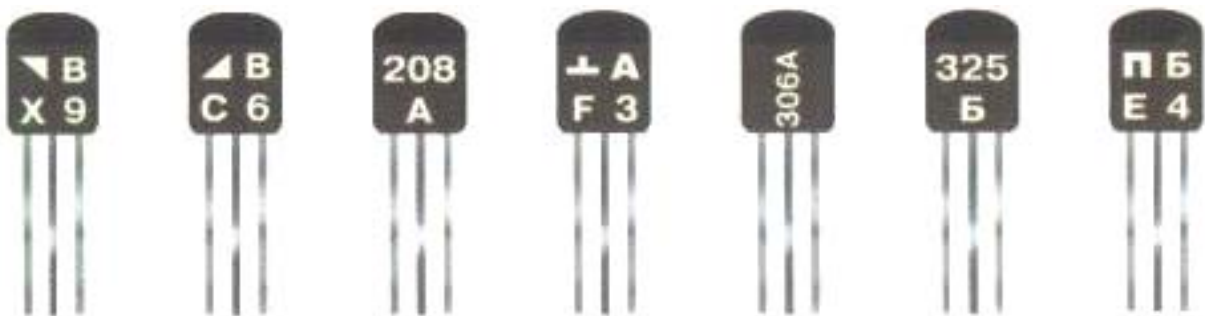

KT324B KT203B KT208A KT313A KT306A KT325B KT698

ПРИМЕРЫ НЕСТАНДАРТНЫХ КОДОВЫХ МАРКИРОВОК

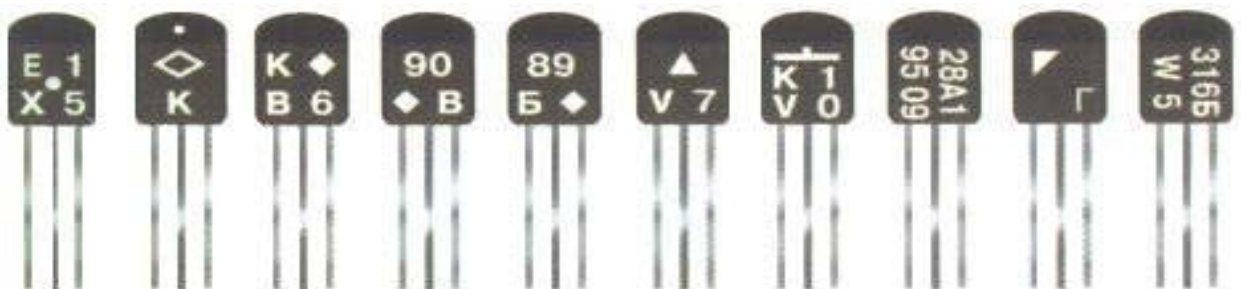

KT208E1 KT209K KT209K KT209B KT209Б KT339AM КП103E1 KT3128A1 KT3102Г KT316Б

ТРАНЗИСТОРЫ. ЦВЕТОВАЯ МАРКИРОВКА. КОРПУС КТ – 26 (ТО - 92)

КТ351А
октябрь 1985 г.

Тип

- Кор. - ● - КТ326
- Кр. - ● - КТ337
- Беж. - ● - КТ345
- Син. - ● - КТ349
- Сер. - ● - КТ350
- Жел. - ● - КТ351
- Зел. - ● - КТ352
- Роз. - ● - КТ363
- Бел. - ● - КТ645
- Гол. - ● - КТ3107

Группа

- Роз. - ● - А
- Жел. - ● - Б
- Син. - ● - В
- Беж. - ● - Г
- Оранж. - ● - Д
- Элект. - ● - Е
- Салат. - ● - Ж
- Зел. - ● - И
- Кр. - ● - К
- Сер. - ● - Л

Месяц выпуска

- Беж. - ● - январь
- Син. - ● - февраль
- Зел. - ● - март
- Кр. - ● - апрель
- Салат. - ● - май
- Сер. - ● - июнь
- Кор. - ● - июль
- Оранж. - ● - август
- Элект. - ● - сентябрь
- Бел. - ● - октябрь
- Желт. - ● - ноябрь
- Гол. - ● - декабрь

Год выпуска

- Беж. - ● - 1977
- Салат. - ● - 1978
- Оранж. - ● - 1979
- Элект. - ● - 1980
- Бирюз. - ● - 1981
- Бел. - ● - 1982
- Кр. - ● - 1983
- Кор. - ● - 1984
- Зел. - ● - 1985
- Гол. - ● - 1986

К Б Э

КТ502А

Тип

- Бордо - ● КТ203
- Сер. - ● КТ209
- Оранж. ● КТ313
- Корич ● КТ336
- Гол. ● КТ339
- Син. ● КТ342
- Желт. ● КТ502
- Бел. ○ КТ503
- Тем.зел. ● КТ3102
- Сереб. ● КТ632
- Табач. ● КТ364

Группа

- Бордо - ● - А
- Желт. ● - Б
- Тем.зел. ● - В
- Гол. ● - Г
- Син. ● - Д
- Бел. ○ - Е
- Тем. кор. ● - Ж
- Сереб. ● - И
- Оранж. ● - К
- Св. табач. ● - Л (И)
- Сер. ● - М (К)

К Б Э

ПРИМЕРЫ НЕСТАНДАРТНЫХ ЦВЕТОВЫХ МАРКИРОВОК

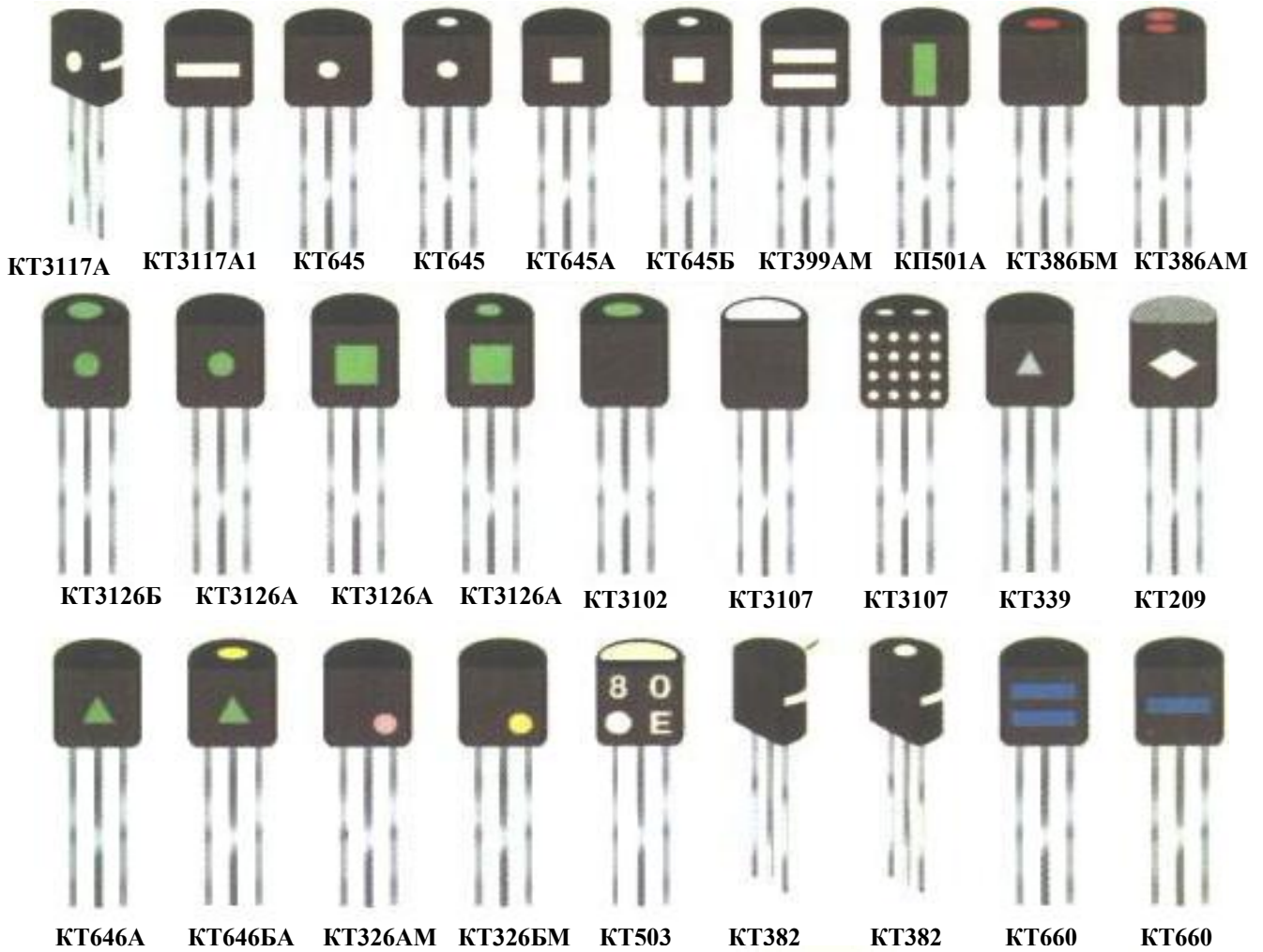

ТРАНЗИСТОРЫ. МАРКИРОВКА. КОРПУС КТ – 27 (ТО - 126)

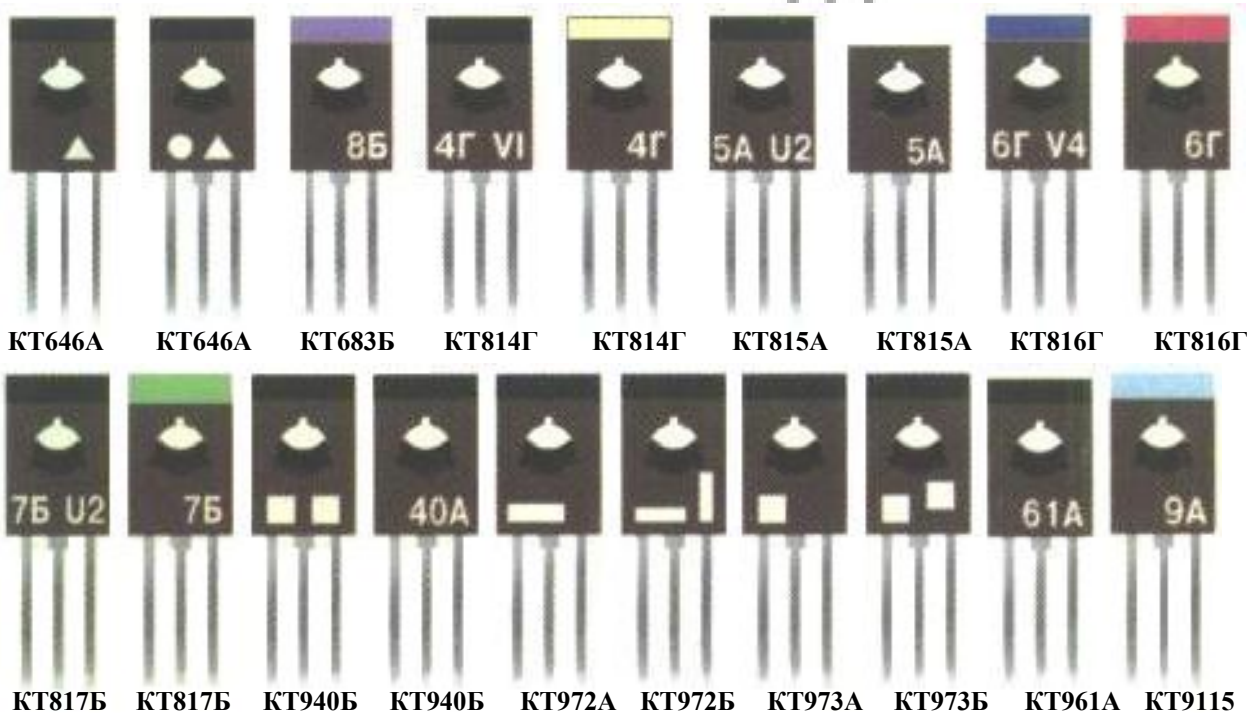
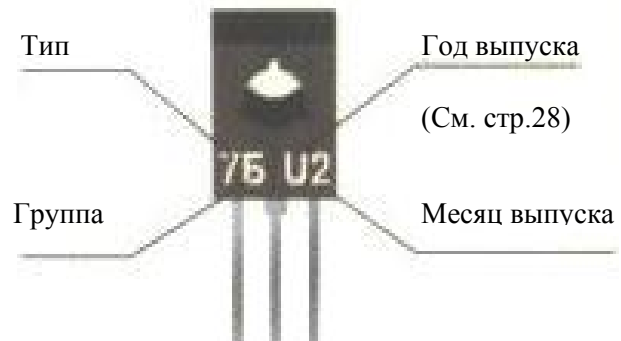

Сортировка по кодам задана с приоритетом цифр перед буквами, следовательно код 618 расположен раньше, чем код 64S и 6A, A1 после 9A.

Для увеличения количества информации в таблицах широко используются сокращения и аббревиатуры. Ниже приведен конкретный пример.

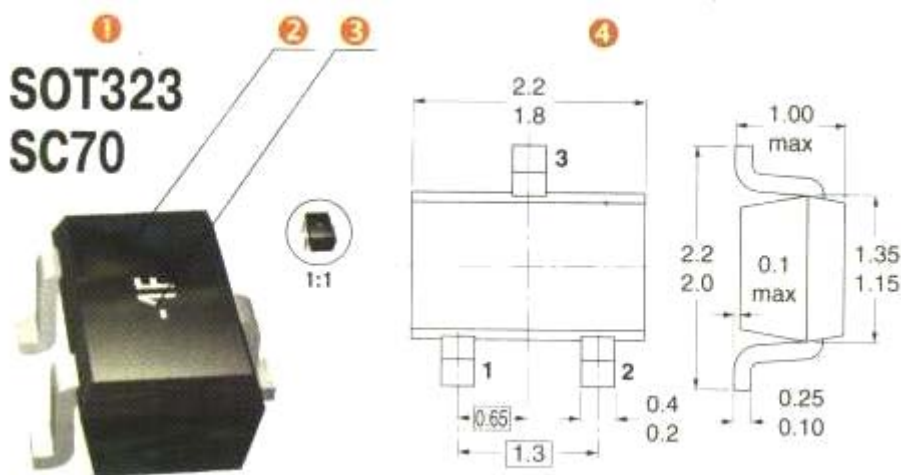

Код	Типономинал	Фирма	Функция	Особенности	Цоколевка		
					1	2	3
WXs	BCR196W	SIEM	PNP	$U_{cb0} = 50 \text{ В}; I_c = 70 \text{ мА}; P_D = 250 \text{ мВт}; h_{21} > 50;$ $f_T > 150 \text{ МГц}$	B	E	C
ZR	MSD1819A-RT1	MOT	NPN	$U_{cb0} = 60 \text{ В}; I_c = 100 \text{ мА}; P_D = 150 \text{ мВт};$ $h_{21} = 210-340;$	E	B	C
E2	HSMP-381C	HP	FP	Два; $I_F < 1 \text{ А}; V_{BR} > 100 \text{ В}; R_T < 3.0 \text{ Ом};$ $C_T < 0.35 \text{ пФ}; R_H > 1500 \text{ Ом}; R_L < 100 \text{ Ом}$	A1	K2 A2	K1
JF	BAL99W	PHIL	FD	$V_R > 70 \text{ В}; I_F < 150 \text{ А}; V_F (I_F = 50 \text{ мА}) < 1.0 \text{ В};$ $C_D < 1.5 \text{ пФ}; T_{RR} < 4 \text{ нс}$	nc	K	A
G0	HSMP-389B	HP	PIN	$I_F < 1 \text{ А}; V_{BR} > 100 \text{ В}; R_S < 2.5 \text{ Ом}; C_T < 0.30 \text{ пФ}$	A	nc	K
63	BAS40W	PHIL	SHD	$V_R > 40 \text{ В}; I_F < 120 \text{ А}; V_F (I_F = 1 \text{ мА}) < 380 \text{ В};$ $C_D < 5 \text{ пФ}; T_{RR} < 0.1 \text{ нс}$	A	nc	K

5 6 7 8 9 10

1 - название корпуса (EIAJ, JEDEC...)

2 - общий вид (не в масштабе)

3 - код, нанесенный на корпус

4 - габаритный чертеж с указанием цоколевки

5 - возможные варианты кодов. Возможны ситуации, когда совпадают код и тип корпуса, а приборы разные. Например, на корпусе типа SOT323 нанесен код 6H.

У фирмы PHILIPS это NPN-транзистор типа BC818W, а у фирмы MOTOROLA – это PNP-транзистор типа MUN5131T1 с совершенно другими параметрами.

6 - типономинал (полное название прибора)

7 - сокращенное название фирмы производителя. Например, SIEM – фирма SIEMENS, HP – Hewlett-Packard и т. д. Для расшифровки необходимо воспользоваться списком на стр. 155

9 - функциональное назначение прибора. Например, NPN – транзистор с указанной проводимостью, SHD – диод Шоттки и т. д. Для расшифровки необходимо воспользоваться списком на стр. 159

10 - цоколевка (см. габаритный). Для расшифровки необходимо воспользоваться списком на стр. 158

DO – 214 AA SMB

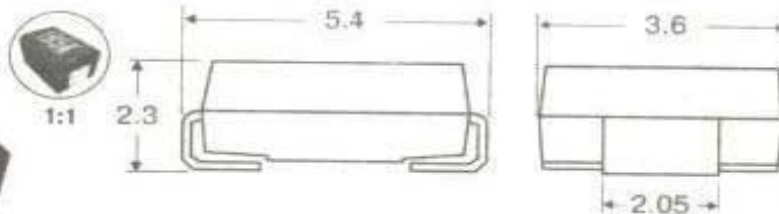

Первый вывод полярных приборов маркируется точкой, выемкой или полосой у катода

Код	Типономинал	Фирма	Функция	Особенности	Цоколевка	
					1	2
AD	SMBJ5.0C	VISH	VS	$V_{BR}(I_T=10.0\text{mA})=6.40\dots 7.55\text{B}; V_{WM}=5.0\text{B}; I_{pp}=62.5\text{A}$	x	x
AE	SMBJ5.0CA	VISH	VS	$V_{BR}(I_T=10.0\text{mA})=6.40\dots 7.23\text{B}; V_{WM}=5.0\text{B}; I_{pp}=65.2\text{A}$	x	x
AF	SMBJ6.0C	VISH	VS	$V_{BR}(I_T=10.0\text{mA})=6.67\dots 8.45\text{B}; V_{WM}=6.0\text{B}; I_{pp}=52.6\text{A}$	x	x
AG	SMBJ6.0CA	VISH	VS	$V_{BR}(I_T=10.0\text{mA})=6.67\dots 7.67\text{B}; V_{WM}=6.0\text{B}; I_{pp}=58.3\text{A}$	x	x
AH	SMBJ6.5C	VISH	VS	$V_{BR}(I_T=10.0\text{mA})=7.22\dots 9.14\text{B}; V_{WM}=6.5\text{B}; I_{pp}=48.7\text{A}$	x	x
AK	SMBJ6.5CA	VISH	VS	$V_{BR}(I_T=10.0\text{mA})=7.22\dots 8.30\text{B}; V_{WM}=6.5\text{B}; I_{pp}=53.6\text{A}$	x	x
AL	SMBJ7.0C	VISH	VS	$V_{BR}(I_T=10.0\text{mA})=7.78\dots 9.86\text{B}; V_{WM}=7.0\text{B}; I_{pp}=45.1\text{A}$	x	x
AM	SMBJ7.0CA	VISH	VS	$V_{BR}(I_T=10.0\text{mA})=7.78\dots 8.95\text{B}; V_{WM}=7.0\text{B}; I_{pp}=50.0\text{A}$	x	x
AN	SMBJ7.5C	VISH	VS	$V_{BR}(I_T=1.00\text{mA})=8.33\dots 10.80\text{B}; V_{WM}=7.5\text{B}; I_{pp}=42.0\text{A}$	x	x
AP	SMBJ7.5CA	VISH	VS	$V_{BR}(I_T=1.00\text{mA})=8.33\dots 9.58\text{B}; V_{WM}=7.5\text{B}; I_{pp}=46.5\text{A}$	x	x
AQ	SMBJ8.0C	VISH	VS	$V_{BR}(I_T=1.00\text{mA})=8.89\dots 11.30\text{B}; V_{WM}=8.0\text{B}; I_{pp}=40.0\text{A}$	x	x
AR	SMBJ8.0CA	VISH	VS	$V_{BR}(I_T=1.00\text{mA})=8.89\dots 10.23\text{B}; V_{WM}=8.0\text{B}; I_{pp}=44.1\text{A}$	x	x
AS	SMBJ8.5C	VISH	VS	$V_{BR}(I_T=1.00\text{mA})=9.44\dots 11.92\text{B}; V_{WM}=8.5\text{B}; I_{pp}=37.7\text{A}$	x	x
AT	SMBJ8.5CA	VISH	VS	$V_{BR}(I_T=1.00\text{mA})=9.44\dots 10.82\text{B}; V_{WM}=8.5\text{B}; I_{pp}=41.7\text{A}$	x	x
AU	SMBJ9.0C	VISH	VS	$V_{BR}(I_T=1.00\text{mA})=10.00\dots 12.80\text{B}; V_{WM}=9.0\text{B}; I_{pp}=35.5\text{A}$	x	x
AV	SMBJ9.0CA	VISH	VS	$V_{BR}(I_T=1.00\text{mA})=10.00\dots 11.50\text{B}; V_{WM}=9.0\text{B}; I_{pp}=39.0\text{A}$	x	x
AW	SMBJ10.0C	VISH	VS	$V_{BR}(I_T=1.00\text{mA})=11.10\dots 14.10\text{B}; V_{WM}=10.0\text{B}; I_{pp}=31.9\text{A}$	x	x
AX	SMBJ10.0CA	VISH	VS	$V_{BR}(I_T=1.00\text{mA})=11.10\dots 12.80\text{B}; V_{WM}=10.0\text{B}; I_{pp}=35.3\text{A}$	x	x
AY	SMBJ11C	VISH	VS	$V_{BR}(I_T=1.00\text{mA})=12.20\dots 15.40\text{B}; V_{WM}=11.0\text{B}; I_{pp}=29.9\text{A}$	x	x
AZ	SMBJ11CA	VISH	VS	$V_{BR}(I_T=1.00\text{mA})=12.20\dots 14.40\text{B}; V_{WM}=11.0\text{B}; I_{pp}=33.0\text{A}$	x	x
BD	SMBJ12C	VISH	VS	$V_{BR}(I_T=1.00\text{mA})=13.30\dots 16.90\text{B}; V_{WM}=12.0\text{B}; I_{pp}=27.3\text{A}$	x	x
BE	SMBJ12CA	VISH	VS	$V_{BR}(I_T=1.00\text{mA})=13.30\dots 15.30\text{B}; V_{WM}=12.0\text{B}; I_{pp}=30.2\text{A}$	x	x
BF	SMBJ13C	VISH	VS	$V_{BR}(I_T=1.00\text{mA})=14.40\dots 18.20\text{B}; V_{WM}=13.0\text{B}; I_{pp}=25.2\text{A}$	x	x
BG	SMBJ13CA	VISH	VS	$V_{BR}(I_T=1.00\text{mA})=14.40\dots 16.50\text{B}; V_{WM}=13.0\text{B}; I_{pp}=27.9\text{A}$	x	x
BH	SMBJ14C	VISH	VS	$V_{BR}(I_T=1.00\text{mA})=15.60\dots 19.80\text{B}; V_{WM}=14.0\text{B}; I_{pp}=23.3\text{A}$	x	x
BK	SMBJ14CA	VISH	VS	$V_{BR}(I_T=1.00\text{mA})=15.60\dots 17.90\text{B}; V_{WM}=14.0\text{B}; I_{pp}=25.8\text{A}$	x	x
BL	SMBJ15C	VISH	VS	$V_{BR}(I_T=1.00\text{mA})=16.70\dots 21.10\text{B}; V_{WM}=15.0\text{B}; I_{pp}=22.3\text{A}$	x	x
BM	SMBJ15CA	VISH	VS	$V_{BR}(I_T=1.00\text{mA})=16.70\dots 19.20\text{B}; V_{WM}=15.0\text{B}; I_{pp}=24.0\text{A}$	x	x
BN	SMBJ16C	VISH	VS	$V_{BR}(I_T=1.00\text{mA})=17.80\dots 22.60\text{B}; V_{WM}=16.0\text{B}; I_{pp}=20.8\text{A}$	x	x
BP	SMBJ16CA	VISH	VS	$V_{BR}(I_T=1.00\text{mA})=17.80\dots 20.50\text{B}; V_{WM}=16.0\text{B}; I_{pp}=23.1\text{A}$	x	x
BQ	SMBJ17C	VISH	VS	$V_{BR}(I_T=1.00\text{mA})=18.90\dots 23.90\text{B}; V_{WM}=17.0\text{B}; I_{pp}=19.7\text{A}$	x	x
BR	SMBJ17CA	VISH	VS	$V_{BR}(I_T=1.00\text{mA})=18.90\dots 21.70\text{B}; V_{WM}=17.0\text{B}; I_{pp}=21.7\text{A}$	x	x
BS	SMBJ18C	VISH	VS	$V_{BR}(I_T=1.00\text{mA})=20.00\dots 25.30\text{B}; V_{WM}=18.0\text{B}; I_{pp}=18.6\text{A}$	x	x
BT	SMBJ18CA	VISH	VS	$V_{BR}(I_T=1.00\text{mA})=20.00\dots 23.30\text{B}; V_{WM}=18.0\text{B}; I_{pp}=20.5\text{A}$	x	x
BU	SMBJ20C	VISH	VS	$V_{BR}(I_T=1.00\text{mA})=22.20\dots 28.10\text{B}; V_{WM}=20.0\text{B}; I_{pp}=16.7\text{A}$	x	x
BV	SMBJ20CA	VISH	VS	$V_{BR}(I_T=1.00\text{mA})=22.20\dots 25.50\text{B}; V_{WM}=20.0\text{B}; I_{pp}=18.5\text{A}$	x	x
BW	SMBJ22C	VISH	VS	$V_{BR}(I_T=1.00\text{mA})=24.40\dots 30.90\text{B}; V_{WM}=22.0\text{B}; I_{pp}=15.2\text{A}$	x	x
BX	SMBJ22CA	VISH	VS	$V_{BR}(I_T=1.00\text{mA})=24.40\dots 28.00\text{B}; V_{WM}=22.0\text{B}; I_{pp}=16.9\text{A}$	x	x
BY	SMBJ24C	VISH	VS	$V_{BR}(I_T=1.00\text{mA})=26.70\dots 33.80\text{B}; V_{WM}=24.0\text{B}; I_{pp}=14.0\text{A}$	x	x
BZ	SMBJ24AC	VISH	VS	$V_{BR}(I_T=1.00\text{mA})=26.70\dots 30.70\text{B}; V_{WM}=24.0\text{B}; I_{pp}=15.4\text{A}$	x	x
CD	SMBJ26C	VISH	VS	$V_{BR}(I_T=1.00\text{mA})=28.90\dots 36.80\text{B}; V_{WM}=26.0\text{B}; I_{pp}=12.4\text{A}$	x	x
CE	SMBJ26CA	VISH	VS	$V_{BR}(I_T=1.00\text{mA})=28.90\dots 33.20\text{B}; V_{WM}=26.0\text{B}; I_{pp}=14.2\text{A}$	x	x
CG	SMBJ28CA	VISH	VS	$V_{BR}(I_T=1.00\text{mA})=31.10\dots 35.80\text{B}; V_{WM}=28.0\text{B}; I_{pp}=13.2\text{A}$	x	x
CH	SMB30C	VISH	VS	$V_{BR}(I_T=1.00\text{mA})=33.30\dots 42.20\text{B}; V_{WM}=30.0\text{B}; I_{pp}=11.2\text{A}$	x	x
CK	SMBJ30CA	VISH	VS	$V_{BR}(I_T=1.00\text{mA})=33.30\dots 38.30\text{B}; V_{WM}=30.0\text{B}; I_{pp}=12.4\text{A}$	x	x

DO-214AA (продолжение)

Код	Типономинал	Фирма	Функция	Особенности	Цоколевка	
					1	2
CL	SMBJ33C	VISH	VS	$V_{BR}(I_T=1.0\text{OмА})=36.70 \dots 46.90\text{В}; V_{WM}=33.0\text{В}; I_{pp}=10.2\text{А}$	x	x
CM	SMBJ33CA	VISH	VS	$V_{BR}(I_T=1.0\text{OмА})=36.70 \dots 42.20\text{В}; V_{WM}=33.0\text{В}; I_{pp}=11.3\text{А}$	x	x
CN	SMBJ36C	VISH	VS	$V_{BR}(I_T=1.0\text{OмА})=40.00 \dots 50.70\text{В}; V_{WM}=36.0\text{В}; I_{pp}=9.3\text{А}$	x	x
CP	SMBJ36CA	VISH	VS	$V_{BR}(I_T=1.0\text{OмА})=40.00 \dots 46.00\text{В}; V_{WM}=36.0\text{В}; I_{pp}=10.3\text{А}$	x	x
CQ	SMBJ40C	VISH	VS	$V_{BR}(I_T=1.0\text{OмА})=44.40 \dots 56.30\text{В}; V_{WM}=40.0\text{В}; I_{pp}=8.4\text{А}$	x	x
CR	SMBJ40CA	VISH	VS	$V_{BR}(I_T=1.0\text{OмА})=44.40 \dots 51.10\text{В}; V_{WM}=40.0\text{В}; I_{pp}=9.3\text{А}$	x	x
CS	SMBJ43C	VISH	VS	$V_{BR}(I_T=1.0\text{OмА})=47.80 \dots 60.50\text{В}; V_{WM}=43.0\text{В}; I_{pp}=7.8\text{А}$	x	x
CT	SMBJ43CA	VISH	VS	$V_{BR}(I_T=1.0\text{OмА})=47.80 \dots 54.90\text{В}; V_{WM}=43.0\text{В}; I_{pp}=8.6\text{А}$	x	x
CU	SMBJ45C	VISH	VS	$V_{BR}(I_T=1.0\text{OмА})=50.00 \dots 63.30\text{В}; V_{WM}=45.0\text{В}; I_{pp}=7.5\text{А}$	x	x
CV	SMBJ45CA	VISH	VS	$V_{BR}(I_T=1.0\text{OмА})=50.00 \dots 57.50\text{В}; V_{WM}=45.0\text{В}; I_{pp}=8.3\text{А}$	x	x
CW	SMBJ48C	VISH	VS	$V_{BR}(I_T=1.0\text{OмА})=53.30 \dots 67.50\text{В}; V_{WM}=48.0\text{В}; I_{pp}=7.0\text{А}$	x	x
CX	SMBJ48CA	VISH	VS	$V_{BR}(I_T=1.0\text{OмА})=53.30 \dots 61.30\text{В}; V_{WM}=48.0\text{В}; I_{pp}=7.7\text{А}$	x	x
CY	SMBJ51C	VISH	VS	$V_{BR}(I_T=1.0\text{OмА})=56.70 \dots 71.80\text{В}; V_{WM}=51.0\text{В}; I_{pp}=6.6\text{А}$	x	x
CZ	SMBJ51CA	VISH	VS	$V_{BR}(I_T=1.0\text{OмА})=56.70 \dots 65.20\text{В}; V_{WM}=51.0\text{В}; I_{pp}=7.3\text{А}$	x	x
DD	SMBJ54C	VISH	VS	$V_{BR}(I_T=1.0\text{OмА})=60.00 \dots 76.00\text{В}; V_{WM}=54.0\text{В}; I_{pp}=6.2\text{А}$	x	x
DE	SMBJ54CA	VISH	VS	$V_{BR}(I_T=1.0\text{OмА})=60.00 \dots 69.00\text{В}; V_{WM}=54.0\text{В}; I_{pp}=6.9\text{А}$	x	x
DF	SMBJ58C	VISH	VS	$V_{BR}(I_T=1.0\text{OмА})=64.40 \dots 81.60\text{В}; V_{WM}=58.0\text{В}; I_{pp}=5.8\text{А}$	x	x
DG	SMBJ58CA	VISH	VS	$V_{BR}(I_T=1.0\text{OмА})=64.40 \dots 74.60\text{В}; V_{WM}=58.0\text{В}; I_{pp}=6.4\text{А}$	x	x
DH	SMBJ60C	VISH	VS	$V_{BR}(I_T=1.0\text{OмА})=66.70 \dots 84.50\text{В}; V_{WM}=60.0\text{В}; I_{pp}=5.6\text{А}$	x	x
DK	SMBJ60CA	VISH	VS	$V_{BR}(I_T=1.0\text{OмА})=66.70 \dots 76.70\text{В}; V_{WM}=60.0\text{В}; I_{pp}=6.2\text{А}$	x	x
DL	SMBJ64C	VISH	VS	$V_{BR}(I_T=1.0\text{OмА})=71.10 \dots 90.10\text{В}; V_{WM}=64.0\text{В}; I_{pp}=5.3\text{А}$	x	x
DM	SMBJ64CA	VISH	VS	$V_{BR}(I_T=1.0\text{OмА})=71.10 \dots 81.80\text{В}; V_{WM}=64.0\text{В}; I_{pp}=5.8\text{А}$	x	x
DN	SMBJ70C	VISH	VS	$V_{BR}(I_T=1.0\text{OмА})=77.80 \dots 98.60\text{В}; V_{WM}=70.0\text{В}; I_{pp}=4.8\text{А}$	x	x
DP	SMBJ70CA	VISH	VS	$V_{BR}(I_T=1.0\text{OмА})=77.80 \dots 89.50\text{В}; V_{WM}=70.0\text{В}; I_{pp}=5.3\text{А}$	x	x
DQ	SMBJ75C	VISH	VS	$V_{BR}(I_T=1.0\text{OмА})=83.30 \dots 106.00\text{В}; V_{WM}=75.0\text{В}; I_{pp}=4.5\text{А}$	x	x
DR	SMBJ75CA	VISH	VS	$V_{BR}(I_T=1.0\text{OмА})=83.30 \dots 95.80\text{В}; V_{WM}=75.0\text{В}; I_{pp}=4.9\text{А}$	x	x
DS	SMBJ78C	VISH	VS	$V_{BR}(I_T=1.0\text{OмА})=86.70 \dots 110.00\text{В}; V_{WM}=78.0\text{В}; I_{pp}=4.3\text{А}$	x	x
DT	SMBJ78CA	VISH	VS	$V_{BR}(I_T=1.0\text{OмА})=86.70 \dots 99.70\text{В}; V_{WM}=78.0\text{В}; I_{pp}=4.7\text{А}$	x	x
DU	SMBJ85C	VISH	VS	$V_{BR}(I_T=1.0\text{OмА})=94.40 \dots 119.20\text{В}; V_{WM}=85.0\text{В}; I_{pp}=3.9\text{А}$	x	x
DV	SMBJ85CA	VISH	VS	$V_{BR}(I_T=1.0\text{OмА})=94.40 \dots 108.20\text{В}; V_{WM}=85.0\text{В}; I_{pp}=4.4\text{А}$	x	x
DW	SMBJ90C	VISH	VS	$V_{BR}(I_T=1.0\text{OмА})=100.0 \dots 126.50\text{В}; V_{WM}=90.0\text{В}; I_{pp}=3.8\text{А}$	x	x
DX	SMBJ90CA	VISH	VS	$V_{BR}(I_T=1.0\text{OмА})=100.0 \dots 115.50\text{В}; V_{WM}=90.0\text{В}; I_{pp}=4.1\text{А}$	x	x
DY	SMBJ100C	VISH	VS	$V_{BR}(I_T=1.0\text{OмА})=111.0 \dots 141.00\text{В}; V_{WM}=100.0\text{В}; I_{pp}=3.4\text{А}$	x	x
DZ	SMBJ100CA	VISH	VS	$V_{BR}(I_T=1.0\text{OмА})=111.0 \dots 128.00\text{В}; V_{WM}=100.0\text{В}; I_{pp}=3.7\text{А}$	x	x
EA	ES2A	GS	FD	$V_R=50\text{В}; I_F=2\text{А}; C_D=18\text{нФ}$	K	A
EB	ES2B	GS	FD	$V_R=100\text{В}; I_F=2\text{А}; C_D=18\text{нФ}$	K	A
EC	ES2C	GS	FD	$V_R=150\text{В}; I_F=2\text{А}; C_D=18\text{нФ}$	K	A
ED	ES2D	GS	FD	$V_R=200\text{В}; I_F=2\text{А}; C_D=18\text{нФ}$	K	A
ED	SMBJ110C	VISH	VS	$V_{BR}(I_T=1.0\text{OмА})=122.0 \dots 154.50\text{В}; V_{WM}=110.0\text{В}; I_{pp}=3.0\text{А}$	x	x
EE	SMBJ110CA	VISH	VS	$V_{BR}(I_T=1.0\text{OмА})=122.0 \dots 140.00\text{В}; V_{WM}=110.0\text{В}; I_{pp}=3.4\text{А}$	x	x
EF	SMBJ120C	VISH	VS	$V_{BR}(I_T=1.0\text{OмА})=133.0 \dots 169.00\text{В}; V_{WM}=120.0\text{В}; I_{pp}=2.8\text{А}$	x	x
EG	SMBJ120CA	VISH	VS	$V_{BR}(I_T=1.0\text{OмА})=133.0 \dots 153.00\text{В}; V_{WM}=120.0\text{В}; I_{pp}=3.1\text{А}$	x	x
EH	SMBJ130C	VISH	VS	$V_{BR}(I_T=1.0\text{OмА})=144.0 \dots 182.50\text{В}; V_{WM}=130.0\text{В}; I_{pp}=2.6\text{А}$	x	x
EK	SMBJ130CA	VISH	VS	$V_{BR}(I_T=1.0\text{OмА})=144.0 \dots 165.50\text{В}; V_{WM}=130.0\text{В}; I_{pp}=2.9\text{А}$	x	x
EL	SMBJ150C	VISH	VS	$V_{BR}(I_T=1.0\text{OмА})=167.0 \dots 211.50\text{В}; V_{WM}=150.0\text{В}; I_{pp}=2.2\text{А}$	x	x
EM	SMBJ150CA	VISH	VS	$V_{BR}(I_T=1.0\text{OмА})=167.0 \dots 192.50\text{В}; V_{WM}=150.0\text{В}; I_{pp}=2.5\text{А}$	x	x
EN	SMBJ160C	VISH	VS	$V_{BR}(I_T=1.0\text{OмА})=178.0 \dots 226.00\text{В}; V_{WM}=160.0\text{В}; I_{pp}=2.1\text{А}$	x	x
EP	SMBJ160CA	VISH	VS	$V_{BR}(I_T=1.0\text{OмА})=178.0 \dots 205.00\text{В}; V_{WM}=160.0\text{В}; I_{pp}=2.3\text{А}$	x	x
EQ	SMBJ170C	VISH	VS	$V_{BR}(I_T=1.0\text{OмА})=189.0 \dots 239.50\text{В}; V_{WM}=170.0\text{В}; I_{pp}=2.0\text{А}$	x	x
ER	SMBJ170CA	VISH	VS	$V_{BR}(I_T=1.0\text{OмА})=189.0 \dots 217.50\text{В}; V_{WM}=170.0\text{В}; I_{pp}=2.2\text{А}$	x	x
KD	SMBJ5.0	VISH	VS	$V_{BR}(I_T=10.0\text{OмА})=6.40 \dots 7.55\text{В}; V_{WM}=5.0\text{В}; I_{pp}=62.5\text{А}$	K	A
KDP	TPSMB6.8	GS	VS	$V_{BR}(I_T=10.0\text{OмА})=6.12 \dots 7.48\text{В}; V_{WM}=5.50\text{В}; I_{pp}=55.6\text{А}$	K	A
KE	SMBJ5.0A	VISH	VS	$V_{BR}(I_T=10.0\text{OмА})=6.40 \dots 7.23\text{В}; V_{WM}=5.0\text{В}; I_{pp}=65.2\text{А}$	K	A

DO-214AA (продолжение)

Код	Типономинал	Фирма	Функция	Особенности	Цоколевка	
					1	2
KEP	SMBJ6.8A	GS	VS	$V_{BR}(I_T=10.0\text{mA})=6.45\dots 7.14\text{B}; V_{WM}=5.80\text{B}; I_{pp}=57.1\text{A}$	K	A
KF	SMBJ6.0	VISH	VS	$V_{BR}(I_T=10.0\text{mA})=6.67\dots 8.45\text{B}; V_{WM}=6.0\text{B}; I_{pp}=52.6\text{A}$	K	A
KFP	TPSMB7.5	GS	VS	$V_{BR}(I_T=10.0\text{mA})=6.75\dots 8.25\text{B}; V_{WM}=6.05\text{B}; I_{pp}=51.3\text{A}$	K	A
KG	SMBJ6.0A	VISH	VS	$V_{BR}(I_T=10.0\text{mA})=6.67\dots 7.67\text{B}; V_{WM}=6.0\text{B}; I_{pp}=58.3\text{A}$	K	A
KGP	TPSMB7.5A	GS	VS	$V_{BR}(I_T=10.0\text{mA})=7.13\dots 7.88\text{B}; V_{WM}=6.40\text{B}; I_{pp}=53.1\text{A}$	K	A
KH	SMBJ6.5	VISH	VS	$V_{BR}(I_T=10.0\text{mA})=7.22\dots 9.14\text{B}; V_{WM}=6.5\text{B}; I_{pp}=48.7\text{A}$	K	A
KHP	TPSMB8.2	GS	VS	$V_{BR}(I_T=10.0\text{mA})=7.38\dots 9.02\text{B}; V_{WM}=6.63\text{B}; I_{pp}=48.0\text{A}$	K	A
KK	SMBJ6.5A	VISH	VS	$V_{BR}(I_T=10.0\text{mA})=7.22\dots 8.30\text{B}; V_{WM}=6.5\text{B}; I_{pp}=53.6\text{A}$	K	A
KKP	TPSMB8.2A	GS	VS	$V_{BR}(I_T=10.0\text{mA})=7.79\dots 8.61\text{B}; V_{WM}=7.02\text{B}; I_{pp}=49.6\text{A}$	K	A
KL	SMBJ7.0	VISH	VS	$V_{BR}(I_T=10.0\text{mA})=7.78\dots 9.86\text{B}; V_{WM}=7.0\text{B}; I_{pp}=45.1\text{A}$	K	A
KLP	TPSMB9.1	GS	VS	$V_{BR}(I_T=10.0\text{mA})=8.19\dots 10.0\text{B}; V_{WM}=7.37\text{B}; I_{pp}=43.5\text{A}$	K	A
KM	SMBJ7.0A	VISH	VS	$V_{BR}(I_T=10.0\text{mA})=7.78\dots 8.95\text{B}; V_{WM}=7.0\text{B}; I_{pp}=50.0\text{A}$	K	A
KMP	TPSMB9.1A	GS	VS	$V_{BR}(I_T=1.00\text{mA})=8.65\dots 9.55\text{B}; V_{WM}=7.78\text{B}; I_{pp}=44.8\text{A}$	K	A
KN	SMBJ7.5	VISH	VS	$V_{BR}(I_T=1.00\text{mA})=8.33\dots 10.80\text{B}; V_{WM}=7.5\text{B}; I_{pp}=42.0\text{A}$	K	A
KNP	TPSMB10	GS	VS	$V_{BR}(I_T=1.00\text{mA})=9.00\dots 11.0\text{B}; V_{WM}=8.10\text{B}; I_{pp}=40.0\text{A}$	K	A
KP	SMBJ7.5A	VISH	VS	$V_{BR}(I_T=1.00\text{mA})=8.33\dots 9.58\text{B}; V_{WM}=7.5\text{B}; I_{pp}=46.5\text{A}$	K	A
KPP	TPSMB10A	GS	VS	$V_{BR}(I_T=1.00\text{mA})=9.50\dots 10.5\text{B}; V_{WM}=8.55\text{B}; I_{pp}=41.4\text{A}$	K	A
KQ	SMBJ8.0	VISH	VS	$V_{BR}(I_T=1.00\text{mA})=8.89\dots 11.30\text{B}; V_{WM}=8.0\text{B}; I_{pp}=40.0\text{A}$	K	A
KQP	TPSMB11	GS	VS	$V_{BR}(I_T=1.00\text{mA})=9.90\dots 12.1\text{B}; V_{WM}=8.92\text{B}; I_{pp}=37.0\text{A}$	K	A
KR	SMBJ8.0A	VISH	VS	$V_{BR}(I_T=1.00\text{mA})=8.89\dots 10.23\text{B}; V_{WM}=8.0\text{B}; I_{pp}=44.1\text{A}$	K	A
KRP	TPSMB11A	GS	VS	$V_{BR}(I_T=1.00\text{mA})=10.5\dots 11.6\text{B}; V_{WM}=9.40\text{B}; I_{pp}=38.5\text{A}$	K	A
KS	SMBJ8.5	VISH	VS	$V_{BR}(I_T=1.00\text{mA})=9.44\dots 11.92\text{B}; V_{WM}=8.5\text{B}; I_{pp}=37.7\text{A}$	K	A
KSP	TPSMB12	GS	VS	$V_{BR}(I_T=1.00\text{mA})=10.8\dots 13.2\text{B}; V_{WM}=9.72\text{B}; I_{pp}=34.7\text{A}$	K	A
KT	SMBJ8.5A	VISH	VS	$V_{BR}(I_T=1.00\text{mA})=9.44\dots 10.82\text{B}; V_{WM}=8.5\text{B}; I_{pp}=41.7\text{A}$	K	A
KTP	TPSMB12A	GS	VS	$V_{BR}(I_T=1.00\text{mA})=11.4\dots 12.6\text{B}; V_{WM}=10.2\text{B}; I_{pp}=35.9\text{A}$	K	A
KU	SMBJ9.0	VISH	VS	$V_{BR}(I_T=1.00\text{mA})=10.00\dots 12.80\text{B}; V_{WM}=9.0\text{B}; I_{pp}=35.5\text{A}$	K	A
KUP	TPSMB13	GS	VS	$V_{BR}(I_T=1.00\text{mA})=11.7\dots 14.3\text{B}; V_{WM}=10.5\text{B}; I_{pp}=31.6\text{A}$	K	A
KV	SMBJ9.0A	VISH	VS	$V_{BR}(I_T=1.00\text{mA})=10.00\dots 11.50\text{B}; V_{WM}=9.0\text{B}; I_{pp}=39.0\text{A}$	K	A
KVP	TPSMB13A	GS	VS	$V_{BR}(I_T=1.00\text{mA})=12.4\dots 13.7\text{B}; V_{WM}=11.1\text{B}; I_{pp}=33.0\text{A}$	K	A
KW	SMBJ10	VISH	VS	$V_{BR}(I_T=1.00\text{mA})=11.10\dots 14.10\text{B}; V_{WM}=10.0\text{B}; I_{pp}=31.9\text{A}$	K	A
KWP	TPSMB15	GS	VS	$V_{BR}(I_T=1.00\text{mA})=13.5\dots 16.5\text{B}; V_{WM}=12.1\text{B}; I_{pp}=27.3\text{A}$	K	A
KX	SMBJ10A	VISH	VS	$V_{BR}(I_T=1.00\text{mA})=11.10\dots 12.80\text{B}; V_{WM}=10.0\text{B}; I_{pp}=35.3\text{A}$	K	A
KXP	TPSMB15A	GS	VS	$V_{BR}(I_T=1.00\text{mA})=14.3\dots 15.8\text{B}; V_{WM}=12.8\text{B}; I_{pp}=28.3\text{A}$	K	A
KY	SMBJ11	VISH	VS	$V_{BR}(I_T=1.00\text{mA})=12.20\dots 15.40\text{B}; V_{WM}=11.0\text{B}; I_{pp}=29.9\text{A}$	K	A
KYP	TPSMB16	GS	VS	$V_{BR}(I_T=1.00\text{mA})=14.4\dots 17.6\text{B}; V_{WM}=12.9\text{B}; I_{pp}=25.5\text{A}$	K	A
KZ	SMBJ11A	VISH	VS	$V_{BR}(I_T=1.00\text{mA})=12.20\dots 14.40\text{B}; V_{WM}=11.0\text{B}; I_{pp}=33.0\text{A}$	K	A
KZP	TPSMB16A	GS	VS	$V_{BR}(I_T=1.00\text{mA})=15.2\dots 16.8\text{B}; V_{WM}=13.6\text{B}; I_{pp}=26.7\text{A}$	K	A
LD	SMBJ12	VISH	VS	$V_{BR}(I_T=1.00\text{mA})=13.30\dots 16.90\text{B}; V_{WM}=12.0\text{B}; I_{pp}=27.3\text{A}$	K	A
LDP	TPSMB18	GS	VS	$V_{BR}(I_T=1.00\text{mA})=16.2\dots 19.8\text{B}; V_{WM}=14.5\text{B}; I_{pp}=22.6\text{A}$	K	A
LE	SMBJ12A	VISH	VS	$V_{BR}(I_T=1.00\text{mA})=13.30\dots 15.30\text{B}; V_{WM}=12.0\text{B}; I_{pp}=30.2\text{A}$	K	A
LEP	TPSMB18A	GS	VS	$V_{BR}(I_T=1.00\text{mA})=17.1\dots 18.9\text{B}; V_{WM}=15.3\text{B}; I_{pp}=23.8\text{A}$	K	A
LF	SMBJ13	VISH	VS	$V_{BR}(I_T=1.00\text{mA})=14.40\dots 18.20\text{B}; V_{WM}=13.0\text{B}; I_{pp}=25.2\text{A}$	K	A
LFP	TPSMB20	GS	VS	$V_{BR}(I_T=1.00\text{mA})=18.0\dots 22.0\text{B}; V_{WM}=16.2\text{B}; I_{pp}=20.6\text{A}$	K	A
LG	SMBJ13A	VISH	VS	$V_{BR}(I_T=1.00\text{mA})=14.40\dots 16.50\text{B}; V_{WM}=13.0\text{B}; I_{pp}=27.9\text{A}$	K	A
LGP	TPSMB20A	GS	VS	$V_{BR}(I_T=1.00\text{mA})=19.0\dots 21.0\text{B}; V_{WM}=17.1\text{B}; I_{pp}=21.7\text{A}$	K	A
LH	SMBJ14	VISH	VS	$V_{BR}(I_T=1.00\text{mA})=15.60\dots 19.80\text{B}; V_{WM}=14.0\text{B}; I_{pp}=23.3\text{A}$	K	A
LHP	TPSMB22	GS	VS	$V_{BR}(I_T=1.00\text{mA})=19.8\dots 24.2\text{B}; V_{WM}=17.8\text{B}; I_{pp}=18.8\text{A}$	K	A
LK	SMBJ14A	VISH	VS	$V_{BR}(I_T=1.00\text{mA})=15.60\dots 17.90\text{B}; V_{WM}=14.0\text{B}; I_{pp}=25.8\text{A}$	K	A
LKP	TPSMB22A	GS	VS	$V_{BR}(I_T=1.00\text{mA})=20.9\dots 23.1\text{B}; V_{WM}=18.8\text{B}; I_{pp}=19.6\text{A}$	K	A
LL	SMBJ15	VISH	VS	$V_{BR}(I_T=1.00\text{mA})=16.70\dots 21.10\text{B}; V_{WM}=15.0\text{B}; I_{pp}=22.3\text{A}$	K	A
LLP	TPSMB24	GS	VS	$V_{BR}(I_T=1.00\text{mA})=21.6\dots 26.4\text{B}; V_{WM}=19.4\text{B}; I_{pp}=17.3\text{A}$	K	A
LM	SMBJ15A	VISH	VS	$V_{BR}(I_T=1.00\text{mA})=16.70\dots 19.20\text{B}; V_{WM}=15.0\text{B}; I_{pp}=24.0\text{A}$	K	A
LMP	TPSMB24A	GS	VS	$V_{BR}(I_T=1.00\text{mA})=22.8\dots 25.2\text{B}; V_{WM}=20.5\text{B}; I_{pp}=18.1\text{A}$	K	A
LN	SMBJ16	VISH	VS	$V_{BR}(I_T=1.00\text{mA})=17.80\dots 22.60\text{B}; V_{WM}=16.0\text{B}; I_{pp}=20.8\text{A}$	K	A
LNP	TPSMB27	GS	VS	$V_{BR}(I_T=1.00\text{mA})=24.3\dots 29.7\text{B}; V_{WM}=21.8\text{B}; I_{pp}=15.3\text{A}$	K	A

DO-214AA (продолжение)

Код	Типономинал	Фирма	Функция	Особенности	Цоколевка	
					1	2
LP	SMBJ16A	VISH	VS	$V_{BR}(I_T=1.00\text{MA})=17.80\dots 20.50\text{B}; V_{WM}=16.0\text{B}; I_{pp}=23.1\text{A}$	K	A
LPP	TPSMB27A	GS	VS	$V_{BR}(I_T=1.00\text{MA})=25.7\dots 28.4\text{B}; V_{WM}=23.1\text{B}; I_{pp}=16.0\text{A}$	K	A
LQ	SMBJ17	VISH	VS	$V_{BR}(I_T=1.00\text{MA})=18.90\dots 23.90\text{B}; V_{WM}=17.0\text{B}; I_{pp}=19.7\text{A}$	K	A
LQP	TPSMB30	GS	VS	$V_{BR}(I_T=1.00\text{MA})=27.0\dots 33.0\text{B}; V_{WM}=24.3\text{B}; I_{pp}=13.8\text{A}$	K	A
LR	SMBJ17A	VISH	VS	$V_{BR}(I_T=1.00\text{MA})=18.90\dots 21.70\text{B}; V_{WM}=17.0\text{B}; I_{pp}=21.7\text{A}$	K	A
LRP	TPSMB30A	GS	VS	$V_{BR}(I_T=1.00\text{MA})=28.5\dots 31.5\text{B}; V_{WM}=25.6\text{B}; I_{pp}=14.5\text{A}$	K	A
LS	SMBJ18	VISH	VS	$V_{BR}(I_T=1.00\text{MA})=20.00\dots 25.30\text{B}; V_{WM}=18.0\text{B}; I_{pp}=18.6\text{A}$	K	A
LSP	TPSMB33	GS	VS	$V_{BR}(I_T=1.00\text{MA})=29.7\dots 36.3\text{B}; V_{WM}=26.8\text{B}; I_{pp}=12.6\text{A}$	K	A
LT	SMBJ18A	VISH	VS	$V_{BR}(I_T=1.00\text{MA})=20.00\dots 23.30\text{B}; V_{WM}=18.0\text{B}; I_{pp}=20.5\text{A}$	K	A
LTP	TPSMB33A	GS	VS	$V_{BR}(I_T=1.00\text{MA})=31.4\dots 34.7\text{B}; V_{WM}=28.2\text{B}; I_{pp}=13.1\text{A}$	K	A
LU	SMBJ20	VISH	VS	$V_{BR}(I_T=1.00\text{MA})=22.20\dots 28.10\text{B}; V_{WM}=20.0\text{B}; I_{pp}=16.7\text{A}$	K	A
LUP	TPSMB36	GS	VS	$V_{BR}(I_T=1.00\text{MA})=32.4\dots 39.6\text{B}; V_{WM}=29.1\text{B}; I_{pp}=11.5\text{A}$	K	A
LV	SMBJ20A	VISH	VS	$V_{BR}(I_T=1.00\text{MA})=22.20\dots 25.50\text{B}; V_{WM}=20.0\text{B}; I_{pp}=18.5\text{A}$	K	A
LVP	TPSMB36A	GS	VS	$V_{BR}(I_T=1.00\text{MA})=34.2\dots 37.8\text{B}; V_{WM}=30.8\text{B}; I_{pp}=12.0\text{A}$	K	A
LW	SMBJ22	VISH	VS	$V_{BR}(I_T=1.00\text{MA})=24.40\dots 30.90\text{B}; V_{WM}=22.0\text{B}; I_{pp}=15.2\text{A}$	K	A
LWP	TPSMB39	GS	VS	$V_{BR}(I_T=1.00\text{MA})=35.1\dots 42.9\text{B}; V_{WM}=31.6\text{B}; I_{pp}=10.6\text{A}$	K	A
LX	SMBJ22A	VISH	VS	$V_{BR}(I_T=1.00\text{MA})=24.40\dots 28.00\text{B}; V_{WM}=22.0\text{B}; I_{pp}=16.9\text{A}$	K	A
LXP	TPSMB39A	GS	VS	$V_{BR}(I_T=1.00\text{MA})=37.1\dots 41.0\text{B}; V_{WM}=33.3\text{B}; I_{pp}=11.1\text{A}$	K	A
LY	SMBJ24	VISH	VS	$V_{BR}(I_T=1.00\text{MA})=26.70\dots 33.80\text{B}; V_{WM}=24.0\text{B}; I_{pp}=14.0\text{A}$	K	A
LYP	TPSMB43	GS	VS	$V_{BR}(I_T=1.00\text{MA})=38.7\dots 47.3\text{B}; V_{WM}=34.8\text{B}; I_{pp}=9.7\text{A}$	K	A
LZ	SMBJ24A	VISH	VS	$V_{BR}(I_T=1.00\text{MA})=26.70\dots 30.70\text{B}; V_{WM}=24.0\text{B}; I_{pp}=15.4\text{A}$	K	A
LZP	TPSMB43A	GS	VS	$V_{BR}(I_T=1.00\text{MA})=40.9\dots 45.2\text{B}; V_{WM}=36.8\text{B}; I_{pp}=10.1\text{A}$	K	A
MD	SMBJ26	VISH	VS	$V_{BR}(I_T=1.00\text{MA})=28.90\dots 36.80\text{B}; V_{WM}=26.0\text{B}; I_{pp}=12.4\text{A}$	K	A
ME	SMBJ26A	VISH	VS	$V_{BR}(I_T=1.00\text{MA})=28.90\dots 33.20\text{B}; V_{WM}=26.0\text{B}; I_{pp}=14.2\text{A}$	K	A
MF	SMBJ28	VISH	VS	$V_{BR}(I_T=1.00\text{MA})=31.10\dots 39.40\text{B}; V_{WM}=28.0\text{B}; I_{pp}=12.0\text{A}$	K	A
MG	SMBJ28A	VISH	VS	$V_{BR}(I_T=1.00\text{MA})=31.10\dots 35.80\text{B}; V_{WM}=28.0\text{B}; I_{pp}=13.2\text{A}$	K	A
MH	SMB30	VISH	VS	$V_{BR}(I_T=1.00\text{MA})=33.30\dots 42.20\text{B}; V_{WM}=30.0\text{B}; I_{pp}=11.2\text{A}$	K	A
MK	SMBJ30	VISH	VS	$V_{BR}(I_T=1.00\text{MA})=33.30\dots 42.20\text{B}; V_{WM}=30.0\text{B}; I_{pp}=11.2\text{A}$	K	A
ML	SMBJ33	VISH	VS	$V_{BR}(I_T=1.00\text{MA})=36.70\dots 46.90\text{B}; V_{WM}=33.0\text{B}; I_{pp}=10.2\text{A}$	K	A
MM	SMBJ33A	VISH	VS	$V_{BR}(I_T=1.00\text{MA})=36.70\dots 42.20\text{B}; V_{WM}=33.0\text{B}; I_{pp}=11.3\text{A}$	K	A
MN	SMBJ36	VISH	VS	$V_{BR}(I_T=1.00\text{MA})=40.00\dots 50.70\text{B}; V_{WM}=36.0\text{B}; I_{pp}=9.3\text{A}$	K	A
MP	SMBJ36A	VISH	VS	$V_{BR}(I_T=1.00\text{MA})=40.00\dots 46.00\text{B}; V_{WM}=36.0\text{B}; I_{pp}=10.3\text{A}$	K	A
MQ	SMBJ40	VISH	VS	$V_{BR}(I_T=1.00\text{MA})=44.40\dots 56.30\text{B}; V_{WM}=40.0\text{B}; I_{pp}=8.4\text{A}$	K	A
MR	SMBJ40A	VISH	VS	$V_{BR}(I_T=1.00\text{MA})=44.40\dots 51.10\text{B}; V_{WM}=40.0\text{B}; I_{pp}=9.3\text{A}$	K	A
MS	SMBJ43	VISH	VS	$V_{BR}(I_T=1.00\text{MA})=47.80\dots 60.50\text{B}; V_{WM}=43.0\text{B}; I_{pp}=7.8\text{A}$	K	A
MT	SMBJ43A	VISH	VS	$V_{BR}(I_T=1.00\text{MA})=47.80\dots 54.90\text{B}; V_{WM}=43.0\text{B}; I_{pp}=8.6\text{A}$	K	A
MU	SMBJ45	VISH	VS	$V_{BR}(I_T=1.00\text{MA})=50.00\dots 63.30\text{B}; V_{WM}=45.0\text{B}; I_{pp}=7.5\text{A}$	K	A
MV	SMBJ45A	VISH	VS	$V_{BR}(I_T=1.00\text{MA})=50.00\dots 57.50\text{B}; V_{WM}=45.0\text{B}; I_{pp}=8.3\text{A}$	K	A
MW	SMBJ48	VISH	VS	$V_{BR}(I_T=1.00\text{MA})=53.30\dots 67.50\text{B}; V_{WM}=48.0\text{B}; I_{pp}=7.0\text{A}$	K	A
MX	SMBJ48A	VISH	VS	$V_{BR}(I_T=1.00\text{MA})=53.30\dots 61.30\text{B}; V_{WM}=48.0\text{B}; I_{pp}=7.7\text{A}$	K	A
MY	SMBJ51	VISH	VS	$V_{BR}(I_T=1.00\text{MA})=56.70\dots 71.80\text{B}; V_{WM}=51.0\text{B}; I_{pp}=6.6\text{A}$	K	A
MZ	SMBJ51A	VISH	VS	$V_{BR}(I_T=1.00\text{MA})=56.70\dots 65.20\text{B}; V_{WM}=51.0\text{B}; I_{pp}=7.3\text{A}$	K	A
ND	SMBJ54	VISH	VS	$V_{BR}(I_T=1.00\text{MA})=60.00\dots 76.00\text{B}; V_{WM}=54.0\text{B}; I_{pp}=6.2\text{A}$	K	A
NE	SMBJ54A	VISH	VS	$V_{BR}(I_T=1.00\text{MA})=60.00\dots 69.00\text{B}; V_{WM}=54.0\text{B}; I_{pp}=6.9\text{A}$	K	A
NF	SMBJ58	VISH	VS	$V_{BR}(I_T=1.00\text{MA})=64.40\dots 81.60\text{B}; V_{WM}=58.0\text{B}; I_{pp}=5.8\text{A}$	K	A
NG	SMBJ58A	VISH	VS	$V_{BR}(I_T=1.00\text{MA})=64.40\dots 74.60\text{B}; V_{WM}=58.0\text{B}; I_{pp}=6.4\text{A}$	K	A
NH	SMBJ60	VISH	VS	$V_{BR}(I_T=1.00\text{MA})=66.70\dots 84.50\text{B}; V_{WM}=60.0\text{B}; I_{pp}=5.6\text{A}$	K	A
NK	SMBJ60A	VISH	VS	$V_{BR}(I_T=1.00\text{MA})=66.70\dots 76.70\text{B}; V_{WM}=60.0\text{B}; I_{pp}=6.2\text{A}$	K	A
NL	SMBJ64	VISH	VS	$V_{BR}(I_T=1.00\text{MA})=71.10\dots 90.10\text{B}; V_{WM}=64.0\text{B}; I_{pp}=5.3\text{A}$	K	A
NM	SMBJ64A	VISH	VS	$V_{BR}(I_T=1.00\text{MA})=71.10\dots 81.80\text{B}; V_{WM}=64.0\text{B}; I_{pp}=5.8\text{A}$	K	A
NN	SMBJ70	VISH	VS	$V_{BR}(I_T=1.00\text{MA})=77.80\dots 98.60\text{B}; V_{WM}=70.0\text{B}; I_{pp}=4.8\text{A}$	K	A
NP	SMBJ70A	VISH	VS	$V_{BR}(I_T=1.00\text{MA})=77.80\dots 89.50\text{B}; V_{WM}=70.0\text{B}; I_{pp}=5.3\text{A}$	K	A
NQ	SMBJ75	VISH	VS	$V_{BR}(I_T=1.00\text{MA})=83.30\dots 106.00\text{B}; V_{WM}=75.0\text{B}; I_{pp}=4.5\text{A}$	K	A
NR	SMBJ75A	VISH	VS	$V_{BR}(I_T=1.00\text{MA})=83.30\dots 95.80\text{B}; V_{WM}=75.0\text{B}; I_{pp}=4.9\text{A}$	K	A

DO-214AA (продолжение)

Код	Типономинал	Фирма	Функция	Особенности	Цоколевка	
					1	2
NS	SMBJ78	VISH	VS	$V_{BR}(I_T=1.00\text{mA})=86.70\dots110.00\text{B}; V_{WM}=78.0\text{B}; I_{pp}=4.3\text{A}$	K	A
NT	SMBJ78A	VISH	VS	$V_{BR}(I_T=1.00\text{mA})=86.70\dots99.70\text{B}; V_{WM}=78.0\text{B}; I_{pp}=4.7\text{A}$	K	A
NU	SMBJ85	VISH	VS	$V_{BR}(I_T=1.00\text{mA})=94.40\dots119.20\text{B}; V_{WM}=85.0\text{B}; I_{pp}=3.9\text{A}$	K	A
NV	SMBJ85A	VISH	VS	$V_{BR}(I_T=1.00\text{mA})=94.40\dots108.20\text{B}; V_{WM}=85.0\text{B}; I_{pp}=4.4\text{A}$	K	A
NW	SMBJ90	VISH	VS	$V_{BR}(I_T=1.00\text{mA})=100.0\dots126.50\text{B}; V_{WM}=90.0\text{B}; I_{pp}=3.8\text{A}$	K	A
NX	SMBJ90A	VISH	VS	$V_{BR}(I_T=1.00\text{mA})=100.0\dots115.50\text{B}; V_{WM}=90.0\text{B}; I_{pp}=4.1\text{A}$	K	A
NY	SMBJ100	VISH	VS	$V_{BR}(I_T=1.00\text{mA})=111.0\dots141.00\text{B}; V_{WM}=100.0\text{B}; I_{pp}=3.4\text{A}$	K	A
NZ	SMBJ100A	VISH	VS	$V_{BR}(I_T=1.00\text{mA})=111.0\dots128.00\text{B}; V_{WM}=100.0\text{B}; I_{pp}=3.7\text{A}$	K	A
PD	SMBJ110	VISH	VS	$V_{BR}(I_T=1.00\text{mA})=122.0\dots154.50\text{B}; V_{WM}=110.0\text{B}; I_{pp}=3.0\text{A}$	K	A
PE	SMBJ110A	VISH	VS	$V_{BR}(I_T=1.00\text{mA})=122.0\dots140.00\text{B}; V_{WM}=110.0\text{B}; I_{pp}=3.4\text{A}$	K	A
PF	SMBJ120	VISH	VS	$V_{BR}(I_T=1.00\text{mA})=133.0\dots169.00\text{B}; V_{WM}=120.0\text{B}; I_{pp}=2.8\text{A}$	K	A
PG	SMBJ120A	VISH	VS	$V_{BR}(I_T=1.00\text{mA})=133.0\dots153.00\text{B}; V_{WM}=120.0\text{B}; I_{pp}=3.1\text{A}$	K	A
PH	SMBJ130	VISH	VS	$V_{BR}(I_T=1.00\text{mA})=144.0\dots182.50\text{B}; V_{WM}=130.0\text{B}; I_{pp}=2.6\text{A}$	K	A
PK	SMBJ130A	VISH	VS	$V_{BR}(I_T=1.00\text{mA})=144.0\dots165.50\text{B}; V_{WM}=130.0\text{B}; I_{pp}=2.9\text{A}$	K	A
PL	SMBJ150	VISH	VS	$V_{BR}(I_T=1.00\text{mA})=167.0\dots211.50\text{B}; V_{WM}=150.0\text{B}; I_{pp}=2.2\text{A}$	K	A
PM	SMBJ150A	VISH	VS	$V_{BR}(I_T=1.00\text{mA})=167.0\dots192.50\text{B}; V_{WM}=150.0\text{B}; I_{pp}=2.5\text{A}$	K	A
PN	SMBJ160	VISH	VS	$V_{BR}(I_T=1.00\text{mA})=178.0\dots226.00\text{B}; V_{WM}=160.0\text{B}; I_{pp}=2.1\text{A}$	K	A
PP	SMBJ160A	VISH	VS	$V_{BR}(I_T=1.00\text{mA})=178.0\dots205.00\text{B}; V_{WM}=160.0\text{B}; I_{pp}=2.3\text{A}$	K	A
PQ	SMBJ170	VISH	VS	$V_{BR}(I_T=1.00\text{mA})=189.0\dots239.50\text{B}; V_{WM}=170.0\text{B}; I_{pp}=2.0\text{A}$	K	A
PR	SMBJ170A	VISH	VS	$V_{BR}(I_T=1.00\text{mA})=189.0\dots217.50\text{B}; V_{WM}=170.0\text{B}; I_{pp}=2.2\text{A}$	K	A
WA	SMZJ3789A	GS	DZ	$V_z(I_z=37.5\text{mA})=10\text{B} \pm 10\%; Z_{Z1}=5.0\text{OM}$	K	A
WB	SMZJ3789B	GS	DZ	$V_z(I_z=37.5\text{mA})=10\text{B} \pm 5\%; Z_{Z1}=5.0\text{OM}$	K	A
WC	SMZJ3790A	GS	DZ	$V_z(I_z=34.1\text{mA})=11\text{B} \pm 10\%; Z_{Z1}=6.0\text{OM}$	K	A
WD	SMZJ3790B	GS	DZ	$V_z(I_z=34.1\text{mA})=11\text{B} \pm 5\%; Z_{Z1}=6.0\text{OM}$	K	A
WE	SMZJ3791A	GS	DZ	$V_z(I_z=31.2\text{mA})=12\text{B} \pm 10\%; Z_{Z1}=7.0\text{OM}$	K	A
WF	SMZJ3791B	GS	DZ	$V_z(I_z=31.2\text{mA})=12\text{B} \pm 5\%; Z_{Z1}=7.0\text{OM}$	K	A
WG	SMZJ3792A	GS	DZ	$V_z(I_z=28.8\text{mA})=13\text{B} \pm 10\%; Z_{Z1}=7.5\text{OM}$	K	A
WH	SMZJ3792B	GS	DZ	$V_z(I_z=28.8\text{mA})=13\text{B} \pm 5\%; Z_{Z1}=7.5\text{OM}$	K	A
WI	SMZJ3793A	GS	DZ	$V_z(I_z=25.0\text{mA})=15\text{B} \pm 10\%; Z_{Z1}=9.0\text{OM}$	K	A
WJ	SMZJ3793B	GS	DZ	$V_z(I_z=25.0\text{mA})=15\text{B} \pm 5\%; Z_{Z1}=9.0\text{OM}$	K	A
WK	SMZJ3794A	GS	DZ	$V_z(I_z=23.4\text{mA})=16\text{B} \pm 10\%; Z_{Z1}=10.0\text{OM}$	K	A
WL	SMZJ3794B	GS	DZ	$V_z(I_z=23.4\text{mA})=16\text{B} \pm 5\%; Z_{Z1}=10.0\text{OM}$	K	A
XA	SMZJ3796A	GS	DZ	$V_z(I_z=18.7\text{mA})=20\text{B} \pm 10\%; Z_{Z1}=14.0\text{OM}$	K	A
XB	SMZJ3795B	GS	DZ	$V_z(I_z=20.8\text{mA})=18\text{B} \pm 5\%; Z_{Z1}=12.0\text{OM}$	K	A
XC	SMZJ3795A	GS	DZ	$V_z(I_z=20.8\text{mA})=18\text{B} \pm 10\%; Z_{Z1}=12.0\text{OM}$	K	A
XD	SMZJ3796B	GS	DZ	$V_z(I_z=18.7\text{mA})=20\text{B} \pm 5\%; Z_{Z1}=14.0\text{OM}$	K	A
XE	SMZJ3797A	GS	DZ	$V_z(I_z=17.0\text{mA})=22\text{B} \pm 10\%; Z_{Z1}=17.5\text{OM}$	K	A
XF	SMZJ3797B	GS	DZ	$V_z(I_z=17.0\text{mA})=22\text{B} \pm 5\%; Z_{Z1}=17.5\text{OM}$	K	A
XG	SMZJ3798A	GS	DZ	$V_z(I_z=15.6\text{mA})=24\text{B} \pm 10\%; Z_{Z1}=19.0\text{OM}$	K	A
XH	SMZJ3798B	GS	DZ	$V_z(I_z=15.6\text{mA})=24\text{B} \pm 5\%; Z_{Z1}=19.0\text{OM}$	K	A
XI	SMZJ3799A	GS	DZ	$V_z(I_z=13.9\text{mA})=27\text{B} \pm 10\%; Z_{Z1}=23.0\text{OM}$	K	A
XJ	SMZJ3799B	GS	DZ	$V_z(I_z=13.9\text{mA})=27\text{B} \pm 5\%; Z_{Z1}=23.0\text{OM}$	K	A
XK	SMZJ3800A	GS	DZ	$V_z(I_z=12.5\text{mA})=30\text{B} \pm 10\%; Z_{Z1}=26.0\text{OM}$	K	A
XL	SMZJ3800B	GS	DZ	$V_z(I_z=12.5\text{mA})=30\text{B} \pm 5\%; Z_{Z1}=26.0\text{OM}$	K	A
YA	SMZJ3801A	GS	DZ	$V_z(I_z=11.4\text{mA})=33\text{B} \pm 10\%; Z_{Z1}=33.0\text{OM}$	K	A
YB	SMZJ3801B	GS	DZ	$V_z(I_z=11.4\text{mA})=33\text{B} \pm 5\%; Z_{Z1}=33.0\text{OM}$	K	A
YC	SMZJ3802A	GS	DZ	$V_z(I_z=10.4\text{mA})=36\text{B} \pm 10\%; Z_{Z1}=38.0\text{OM}$	K	A
YD	SMZJ3802B	GS	DZ	$V_z(I_z=10.4\text{mA})=36\text{B} \pm 5\%; Z_{Z1}=38.0\text{OM}$	K	A
YE	SMZJ3803A	GS	DZ	$V_z(I_z=9.6\text{mA})=39\text{B} \pm 10\%; Z_{Z1}=45.0\text{OM}$	K	A
YF	SMZJ3803B	GS	DZ	$V_z(I_z=9.6\text{mA})=39\text{B} \pm 5\%; Z_{Z1}=45.0\text{OM}$	K	A
YG	SMZJ3804A	GS	DZ	$V_z(I_z=8.7\text{mA})=43\text{B} \pm 10\%; Z_{Z1}=53.0\text{OM}$	K	A
YH	SMZJ3804B	GS	DZ	$V_z(I_z=8.7\text{mA})=43\text{B} \pm 5\%; Z_{Z1}=53.0\text{OM}$	K	A
YI	SMZJ3805A	GS	DZ	$V_z(I_z=8.0\text{mA})=47\text{B} \pm 10\%; Z_{Z1}=67.0\text{OM}$	K	A
YJ	SMZJ3805B	GS	DZ	$V_z(I_z=8.0\text{mA})=47\text{B} \pm 5\%; Z_{Z1}=67.0\text{OM}$	K	A
YK	SMZJ3806A	GS	DZ	$V_z(I_z=7.3\text{mA})=51\text{B} \pm 10\%; Z_{Z1}=70.0\text{OM}$	K	A

DO-214AA (продолжение)

Код	Типономинал	Фирма	Функция	Особенности	Цоколевка	
					1	2
YL	SMZJ3806B	GS	DZ	$V_z(I_z=7.3\text{mA})=51\text{B} \pm 5\%$; $Z_{z1}=70.00\text{Oм}$	K	A
ZA	SMZJ3807A	GS	DZ	$V_z(I_z=6.7\text{mA})=56\text{B} \pm 10\%$; $Z_{z1}=86.00\text{Oм}$	K	A
ZC	SMZJ3808A	GS	DZ	$V_z(I_z=6.0\text{mA})=62\text{B} \pm 10\%$; $Z_{z1}=100.00\text{Oм}$	K	A
ZB	SMZJ3807B	GS	DZ	$V_z(I_z=6.7\text{mA})=56\text{B} \pm 5\%$; $Z_{z1}=86.00\text{Oм}$	K	A
ZD	SMZJ3808B	GS	DZ	$V_z(I_z=6.0\text{mA})=62\text{B} \pm 5\%$; $Z_{z1}=100.00\text{Oм}$	K	A
ZE	SMZJ3809A	GS	DZ	$V_z(I_z=5.5\text{mA})=68\text{B} \pm 10\%$; $Z_{z1}=120.00\text{Oм}$	K	A
ZF	SMZJ3808B	GS	DZ	$V_z(I_z=5.5\text{mA})=68\text{B} \pm 50\%$; $Z_{z1}=120.00\text{Oм}$	K	A

DO-214AB
SMC

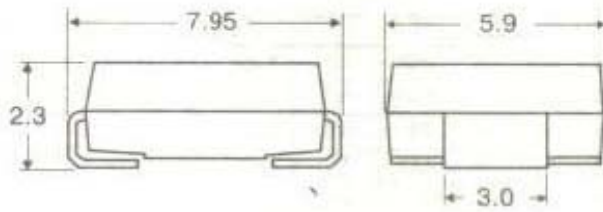

Первый вывод полярных приборов маркируется точкой, выемкой или полосой у катода

Код	Типономинал	Фирма	Функция	Особенности	Цоколевка	
					1	2
BDD	SMCJ5.0C	VISH	VS	$V_{BR}(I_T=10.0\text{mA})=6.40\dots 7.55\text{B}; V_{WM}=5.0\text{B}; I_{pp}=156.2\text{A}$	x	x
BDE	SMCJ5.0CA	VISH	VS	$V_{BR}(I_T=10.0\text{mA})=6.40\dots 7.25\text{B}; V_{WM}=5.0\text{B}; I_{pp}=163.0\text{A}$	x	x
BDF	SMCJ6.0C	VISH	VS	$V_{BR}(I_T=10.0\text{mA})=6.67\dots 8.45\text{B}; V_{WM}=6.0\text{B}; I_{pp}=131.6\text{A}$	x	x
BDG	SMCJ6.0CA	VISH	VS	$V_{BR}(I_T=10.0\text{mA})=6.67\dots 7.67\text{B}; V_{WM}=6.0\text{B}; I_{pp}=145.6\text{A}$	x	x
BDH	SMCJ6.5C	VISH	VS	$V_{BR}(I_T=10.0\text{mA})=7.22\dots 9.14\text{B}; V_{WM}=6.5\text{B}; I_{pp}=122.0\text{A}$	x	x
BDK	SMCJ6.5CA	VISH	VS	$V_{BR}(I_T=10.0\text{mA})=7.22\dots 8.30\text{B}; V_{WM}=6.5\text{B}; I_{pp}=133.9\text{A}$	x	x
BDL	SMCJ7.0C	VISH	VS	$V_{BR}(I_T=10.0\text{mA})=7.78\dots 9.86\text{B}; V_{WM}=7.0\text{B}; I_{pp}=112.8\text{A}$	x	x
BDM	SMCJ7.0CA	VISH	VS	$V_{BR}(I_T=10.0\text{mA})=7.78\dots 8.95\text{B}; V_{WM}=7.0\text{B}; I_{pp}=125.0\text{A}$	x	x
BDN	SMCJ7.5C	VISH	VS	$V_{BR}(I_T=1.0\text{mA})=8.33\dots 10.80\text{B}; V_{WM}=7.5\text{B}; I_{pp}=104.9\text{A}$	x	x
BDP	SMCJ7.5CA	VISH	VS	$V_{BR}(I_T=1.0\text{mA})=8.33\dots 9.58\text{B}; V_{WM}=7.5\text{B}; I_{pp}=116.3\text{A}$	x	x
BDQ	SMCJ8.0C	VISH	VS	$V_{BR}(I_T=1.0\text{mA})=8.89\dots 11.30\text{B}; V_{WM}=8.0\text{B}; I_{pp}=100.0\text{A}$	x	x
BDR	SMCJ8.0CA	VISH	VS	$V_{BR}(I_T=1.0\text{mA})=8.89\dots 10.23\text{B}; V_{WM}=8.0\text{B}; I_{pp}=110.3\text{A}$	x	x
BDS	SMCJ8.5C	VISH	VS	$V_{BR}(I_T=1.0\text{mA})=9.44\dots 11.92\text{B}; V_{WM}=8.5\text{B}; I_{pp}=94.3\text{A}$	x	x
BDT	SMCJ8.5CA	VISH	VS	$V_{BR}(I_T=1.0\text{mA})=9.44\dots 10.82\text{B}; V_{WM}=8.5\text{B}; I_{pp}=104.2\text{A}$	x	x
BDU	SMCJ9.0C	VISH	VS	$V_{BR}(I_T=1.0\text{mA})=10.00\dots 12.80\text{B}; V_{WM}=9.0\text{B}; I_{pp}=88.7\text{A}$	x	x
BDV	SMCJ9.0CA	VISH	VS	$V_{BR}(I_T=1.0\text{mA})=10.00\dots 11.50\text{B}; V_{WM}=9.0\text{B}; I_{pp}=97.4\text{A}$	x	x
BDW	SMCJ10C	VISH	VS	$V_{BR}(I_T=1.0\text{mA})=11.10\dots 14.10\text{B}; V_{WM}=10.0\text{B}; I_{pp}=79.8\text{A}$	x	x
BDX	SMCJ10CA	VISH	VS	$V_{BR}(I_T=1.0\text{mA})=11.10\dots 12.80\text{B}; V_{WM}=10.0\text{B}; I_{pp}=88.2\text{A}$	x	x
BDY	SMCJ11C	VISH	VS	$V_{BR}(I_T=1.0\text{mA})=12.20\dots 15.40\text{B}; V_{WM}=11.0\text{B}; I_{pp}=74.6\text{A}$	x	x
BDZ	SMCJ11CA	VISH	VS	$V_{BR}(I_T=1.0\text{mA})=12.20\dots 14.40\text{B}; V_{WM}=11.0\text{B}; I_{pp}=82.4\text{A}$	x	x
BED	SMCJ12C	VISH	VS	$V_{BR}(I_T=1.0\text{mA})=13.30\dots 16.90\text{B}; V_{WM}=11.0\text{B}; I_{pp}=68.2\text{A}$	x	x
BEE	SMCJ12CA	VISH	VS	$V_{BR}(I_T=1.0\text{mA})=13.30\dots 15.30\text{B}; V_{WM}=11.0\text{B}; I_{pp}=75.3\text{A}$	x	x
BEF	SMCJ13C	VISH	VS	$V_{BR}(I_T=1.0\text{mA})=14.40\dots 18.20\text{B}; V_{WM}=13.0\text{B}; I_{pp}=63.0\text{A}$	x	x
BEG	SMCJ13CA	VISH	VS	$V_{BR}(I_T=1.0\text{mA})=14.40\dots 16.50\text{B}; V_{WM}=13.0\text{B}; I_{pp}=69.7\text{A}$	x	x
BEH	SMCJ14C	VISH	VS	$V_{BR}(I_T=1.0\text{mA})=15.60\dots 19.80\text{B}; V_{WM}=14.0\text{B}; I_{pp}=58.1\text{A}$	x	x
BEK	SMCJ14CA	VISH	VS	$V_{BR}(I_T=1.0\text{mA})=15.60\dots 17.90\text{B}; V_{WM}=14.0\text{B}; I_{pp}=64.7\text{A}$	x	x
BEL	SMCJ15C	VISH	VS	$V_{BR}(I_T=1.0\text{mA})=16.70\dots 21.10\text{B}; V_{WM}=15.0\text{B}; I_{pp}=55.8\text{A}$	x	x
BEM	SMCJ15CA	VISH	VS	$V_{BR}(I_T=1.0\text{mA})=16.70\dots 19.20\text{B}; V_{WM}=15.0\text{B}; I_{pp}=61.5\text{A}$	x	x
BEN	SMCJ16C	VISH	VS	$V_{BR}(I_T=1.0\text{mA})=17.80\dots 22.60\text{B}; V_{WM}=16.0\text{B}; I_{pp}=52.1\text{A}$	x	x
BEP	SMCJ16CA	VISH	VS	$V_{BR}(I_T=1.0\text{mA})=17.80\dots 20.50\text{B}; V_{WM}=16.0\text{B}; I_{pp}=57.7\text{A}$	x	x
BEQ	SMCJ17C	VISH	VS	$V_{BR}(I_T=1.0\text{mA})=18.90\dots 23.90\text{B}; V_{WM}=17.0\text{B}; I_{pp}=49.2\text{A}$	x	x
BER	SMCJ17CA	VISH	VS	$V_{BR}(I_T=1.0\text{mA})=18.90\dots 21.70\text{B}; V_{WM}=17.0\text{B}; I_{pp}=53.3\text{A}$	x	x
BES	SMCJ18C	VISH	VS	$V_{BR}(I_T=1.0\text{mA})=20.00\dots 25.30\text{B}; V_{WM}=18.0\text{B}; I_{pp}=46.6\text{A}$	x	x
BET	SMCJ18CA	VISH	VS	$V_{BR}(I_T=1.0\text{mA})=20.00\dots 23.30\text{B}; V_{WM}=18.0\text{B}; I_{pp}=51.4\text{A}$	x	x
BEU	SMCJ20C	VISH	VS	$V_{BR}(I_T=1.0\text{mA})=22.20\dots 28.10\text{B}; V_{WM}=20.0\text{B}; I_{pp}=41.9\text{A}$	x	x
BEV	SMCJ20CA	VISH	VS	$V_{BR}(I_T=1.0\text{mA})=22.20\dots 25.50\text{B}; V_{WM}=20.0\text{B}; I_{pp}=46.3\text{A}$	x	x
BEW	SMCJ22C	VISH	VS	$V_{BR}(I_T=1.0\text{mA})=24.40\dots 30.90\text{B}; V_{WM}=22.0\text{B}; I_{pp}=38.1\text{A}$	x	x
BEX	SMCJ22CA	VISH	VS	$V_{BR}(I_T=1.0\text{mA})=24.40\dots 28.00\text{B}; V_{WM}=22.0\text{B}; I_{pp}=42.2\text{A}$	x	x
BEY	SMCJ24C	VISH	VS	$V_{BR}(I_T=1.0\text{mA})=26.70\dots 38.80\text{B}; V_{WM}=24.0\text{B}; I_{pp}=34.9\text{A}$	x	x
BEZ	SMCJ24CA	VISH	VS	$V_{BR}(I_T=1.0\text{mA})=26.70\dots 30.70\text{B}; V_{WM}=24.0\text{B}; I_{pp}=38.6\text{A}$	x	x
BFD	SMCJ26C	VISH	VS	$V_{BR}(I_T=1.0\text{mA})=28.90\dots 36.80\text{B}; V_{WM}=26.0\text{B}; I_{pp}=32.2\text{A}$	x	x
BFE	SMCJ26CA	VISH	VS	$V_{BR}(I_T=1.0\text{mA})=28.90\dots 33.20\text{B}; V_{WM}=26.0\text{B}; I_{pp}=35.6\text{A}$	x	x
BFF	SMCJ28C	VISH	VS	$V_{BR}(I_T=1.0\text{mA})=31.10\dots 39.40\text{B}; V_{WM}=28.0\text{B}; I_{pp}=30.0\text{A}$	x	x
BFG	SMCJ28CA	VISH	VS	$V_{BR}(I_T=1.0\text{mA})=31.10\dots 35.80\text{B}; V_{WM}=28.0\text{B}; I_{pp}=33.0\text{A}$	x	x
BFH	SMCJ30C	VISH	VS	$V_{BR}(I_T=1.0\text{mA})=33.30\dots 42.40\text{B}; V_{WM}=30.0\text{B}; I_{pp}=28.0\text{A}$	x	x
BFK	SMCJ30CA	VISH	VS	$V_{BR}(I_T=1.0\text{mA})=33.30\dots 38.30\text{B}; V_{WM}=30.0\text{B}; I_{pp}=31.0\text{A}$	x	x
BFL	SMCJ33C	VISH	VS	$V_{BR}(I_T=1.0\text{mA})=36.70\dots 46.90\text{B}; V_{WM}=33.0\text{B}; I_{pp}=25.2\text{A}$	x	x

DO – 214AB (продолжение)

Код	Типономинал	Фирма	Функция	Особенности	Цоколевка	
					1	2
BFM	SMCJ33CA	VISH	VS	$V_{BR}(I_T=1.0\text{OмА})=36.70\dots 42.20\text{В}; V_{WM}=33.0\text{В}; I_{pp}=28.1\text{А}$	x	x
BFN	SMCJ36C	VISH	VS	$V_{BR}(I_T=1.0\text{OмА})=40.00\dots 50.70\text{В}; V_{WM}=36.0\text{В}; I_{pp}=23.3\text{А}$	x	x
BFP	SMCJ36CA	VISH	VS	$V_{BR}(I_T=1.0\text{OмА})=36.70\dots 46.00\text{В}; V_{WM}=33.0\text{В}; I_{pp}=25.8\text{А}$	x	x
BFQ	SMCJ40C	VISH	VS	$V_{BR}(I_T=1.0\text{OмА})=44.40\dots 56.30\text{В}; V_{WM}=40.0\text{В}; I_{pp}=21.0\text{А}$	x	x
BFR	SMCJ40CA	VISH	VS	$V_{BR}(I_T=1.0\text{OмА})=44.40\dots 51.10\text{В}; V_{WM}=40.0\text{В}; I_{pp}=23.2\text{А}$	x	x
BFS	SMCJ43C	VISH	VS	$V_{BR}(I_T=1.0\text{OмА})=47.80\dots 60.50\text{В}; V_{WM}=43.0\text{В}; I_{pp}=19.6\text{А}$	x	x
BFT	SMCJ43CA	VISH	VS	$V_{BR}(I_T=1.0\text{OмА})=47.80\dots 54.90\text{В}; V_{WM}=43.0\text{В}; I_{pp}=21.6\text{А}$	x	x
BFU	SMCJ45C	VISH	VS	$V_{BR}(I_T=1.0\text{OмА})=50.00\dots 63.30\text{В}; V_{WM}=45.0\text{В}; I_{pp}=18.7\text{А}$	x	x
BFV	SMCJ45CA	VISH	VS	$V_{BR}(I_T=1.0\text{OмА})=50.00\dots 57.50\text{В}; V_{WM}=45.0\text{В}; I_{pp}=20.6\text{А}$	x	x
BFW	SMCJ48C	VISH	VS	$V_{BR}(I_T=1.0\text{OмА})=53.30\dots 67.50\text{В}; V_{WM}=48.0\text{В}; I_{pp}=17.5\text{А}$	x	x
BFX	SMCJ48CA	VISH	VS	$V_{BR}(I_T=1.0\text{OмА})=53.30\dots 61.30\text{В}; V_{WM}=48.0\text{В}; I_{pp}=19.4\text{А}$	x	x
BFY	SMCJ51C	VISH	VS	$V_{BR}(I_T=1.0\text{OмА})=56.70\dots 71.80\text{В}; V_{WM}=51.0\text{В}; I_{pp}=16.5\text{А}$	x	x
BFZ	SMCJ51CA	VISH	VS	$V_{BR}(I_T=1.0\text{OмА})=56.70\dots 65.20\text{В}; V_{WM}=51.0\text{В}; I_{pp}=18.2\text{А}$	x	x
BGD	SMCJ54C	VISH	VS	$V_{BR}(I_T=1.0\text{OмА})=60.00\dots 76.00\text{В}; V_{WM}=54.0\text{В}; I_{pp}=15.6\text{А}$	x	x
BGE	SMCJ54CA	VISH	VS	$V_{BR}(I_T=1.0\text{OмА})=60.00\dots 69.00\text{В}; V_{WM}=54.0\text{В}; I_{pp}=17.2\text{А}$	x	x
BGF	SMCJ58C	VISH	VS	$V_{BR}(I_T=1.0\text{OмА})=64.40\dots 81.60\text{В}; V_{WM}=58.0\text{В}; I_{pp}=14.6\text{А}$	x	x
BGG	SMCJ58CA	VISH	VS	$V_{BR}(I_T=1.0\text{OмА})=64.40\dots 74.60\text{В}; V_{WM}=58.0\text{В}; I_{pp}=16.0\text{А}$	x	x
BGH	SMCJ60C	VISH	VS	$V_{BR}(I_T=1.0\text{OмА})=66.70\dots 84.50\text{В}; V_{WM}=60.0\text{В}; I_{pp}=14.0\text{А}$	x	x
BGK	SMCJ60CA	VISH	VS	$V_{BR}(I_T=1.0\text{OмА})=66.70\dots 76.70\text{В}; V_{WM}=60.0\text{В}; I_{pp}=15.5\text{А}$	x	x
BGL	SMCJ64C	VISH	VS	$V_{BR}(I_T=1.0\text{OмА})=71.10\dots 90.10\text{В}; V_{WM}=64.0\text{В}; I_{pp}=13.2\text{А}$	x	x
BGM	SMCJ64CA	VISH	VS	$V_{BR}(I_T=1.0\text{OмА})=71.10\dots 81.80\text{В}; V_{WM}=64.0\text{В}; I_{pp}=14.6\text{А}$	x	x
BGN	SMCJ70C	VISH	VS	$V_{BR}(I_T=1.0\text{OмА})=77.80\dots 98.60\text{В}; V_{WM}=70.0\text{В}; I_{pp}=12.0\text{А}$	x	x
BGP	SMCJ70CA	VISH	VS	$V_{BR}(I_T=1.0\text{OмА})=77.80\dots 89.50\text{В}; V_{WM}=70.0\text{В}; I_{pp}=13.3\text{А}$	x	x
BGQ	SMCJ75C	VISH	VS	$V_{BR}(I_T=1.0\text{OмА})=83.30\dots 106.00\text{В}; V_{WM}=75.0\text{В}; I_{pp}=11.2\text{А}$	x	x
BGR	SMCJ75CA	VISH	VS	$V_{BR}(I_T=1.0\text{OмА})=83.30\dots 95.80\text{В}; V_{WM}=75.0\text{В}; I_{pp}=12.4\text{А}$	x	x
BGS	SMCJ78C	VISH	VS	$V_{BR}(I_T=1.0\text{OмА})=86.70\dots 110.00\text{В}; V_{WM}=78.0\text{В}; I_{pp}=10.8\text{А}$	x	x
BGT	SMCJ78CA	VISH	VS	$V_{BR}(I_T=1.0\text{OмА})=86.70\dots 99.70\text{В}; V_{WM}=78.0\text{В}; I_{pp}=11.4\text{А}$	x	x
BGU	SMCJ85C	VISH	VS	$V_{BR}(I_T=1.0\text{OмА})=94.40\dots 119.20\text{В}; V_{WM}=85.0\text{В}; I_{pp}=9.9\text{А}$	x	x
BGV	SMCJ85CA	VISH	VS	$V_{BR}(I_T=1.0\text{OмА})=94.40\dots 108.20\text{В}; V_{WM}=85.0\text{В}; I_{pp}=10.4\text{А}$	x	x
BGW	SMCJ90C	VISH	VS	$V_{BR}(I_T=1.0\text{OмА})=100.00\dots 126.50\text{В}; V_{WM}=90.0\text{В}; I_{pp}=9.4\text{А}$	x	x
BGX	SMCJ90CA	VISH	VS	$V_{BR}(I_T=1.0\text{OмА})=100.00\dots 115.50\text{В}; V_{WM}=90.0\text{В}; I_{pp}=10.3\text{А}$	x	x
BGY	SMCJ100C	VISH	VS	$V_{BR}(I_T=1.0\text{OмА})=111.00\dots 141.00\text{В}; V_{WM}=100.0\text{В}; I_{pp}=8.4\text{А}$	x	x
BGZ	SMCJ100CA	VISH	VS	$V_{BR}(I_T=1.0\text{OмА})=111.00\dots 128.00\text{В}; V_{WM}=100.0\text{В}; I_{pp}=9.3\text{А}$	x	x
BHD	SMCJ110C	VISH	VS	$V_{BR}(I_T=1.0\text{OмА})=122.00\dots 154.50\text{В}; V_{WM}=110.0\text{В}; I_{pp}=7.7\text{А}$	x	x
BHE	SMCJ110CA	VISH	VS	$V_{BR}(I_T=1.0\text{OмА})=122.00\dots 140.50\text{В}; V_{WM}=110.0\text{В}; I_{pp}=8.4\text{А}$	x	x
BHF	SMCJ120C	VISH	VS	$V_{BR}(I_T=1.0\text{OмА})=133.00\dots 169.00\text{В}; V_{WM}=120.0\text{В}; I_{pp}=7.0\text{А}$	x	x
BHG	SMCJ120CA	VISH	VS	$V_{BR}(I_T=1.0\text{OмА})=133.00\dots 153.00\text{В}; V_{WM}=120.0\text{В}; I_{pp}=7.9\text{А}$	x	x
BHH	SMCJ130C	VISH	VS	$V_{BR}(I_T=1.0\text{OмА})=144.00\dots 182.50\text{В}; V_{WM}=130.0\text{В}; I_{pp}=6.5\text{А}$	x	x
BHK	SMCJ130CA	VISH	VS	$V_{BR}(I_T=1.0\text{OмА})=144.00\dots 165.50\text{В}; V_{WM}=130.0\text{В}; I_{pp}=7.2\text{А}$	x	x
BHL	SMCJ150C	VISH	VS	$V_{BR}(I_T=1.0\text{OмА})=167.00\dots 211.50\text{В}; V_{WM}=150.0\text{В}; I_{pp}=5.6\text{А}$	x	x
BHM	SMCJ150CA	VISH	VS	$V_{BR}(I_T=1.0\text{OмА})=167.00\dots 192.50\text{В}; V_{WM}=150.0\text{В}; I_{pp}=6.2\text{А}$	x	x
BHN	SMCJ160C	VISH	VS	$V_{BR}(I_T=1.0\text{OмА})=178.00\dots 226.00\text{В}; V_{WM}=160.0\text{В}; I_{pp}=5.2\text{А}$	x	x
BHP	SMCJ160CA	VISH	VS	$V_{BR}(I_T=1.0\text{OмА})=178.00\dots 205.00\text{В}; V_{WM}=160.0\text{В}; I_{pp}=5.8\text{А}$	x	x
BHQ	SMCJ170C	VISH	VS	$V_{BR}(I_T=1.0\text{OмА})=189.00\dots 239.50\text{В}; V_{WM}=170.0\text{В}; I_{pp}=4.9\text{А}$	x	x
BHR	SMCJ170CA	VISH	VS	$V_{BR}(I_T=1.0\text{OмА})=189.00\dots 217.50\text{В}; V_{WM}=170.0\text{В}; I_{pp}=5.5\text{А}$	x	x
DDP	TPSMC6.8	GS	VS	$V_{BR}(I_T=10.0\text{мА})=6.12\dots 7.48\text{В}; V_{WM}=5.50\text{В}; I_{pp}=139\text{А}$	K	A
DEP	TPSMC6.8A	GS	VS	$V_{BR}(I_T=10.0\text{мА})=6.45\dots 7.14\text{В}; V_{WM}=5.80\text{В}; I_{pp}=143\text{А}$	K	A
DFP	TPSMC7.5	GS	VS	$V_{BR}(I_T=10.0\text{мА})=6.75\dots 8.25\text{В}; V_{WM}=6.05\text{В}; I_{pp}=128\text{А}$	K	A
DGP	TPSMC7.5A	GS	VS	$V_{BR}(I_T=10.0\text{мА})=7.13\dots 7.88\text{В}; V_{WM}=6.40\text{В}; I_{pp}=133\text{А}$	K	A
DHP	TPSMC8.2	GS	VS	$V_{BR}(I_T=10.0\text{мА})=7.38\dots 9.02\text{В}; V_{WM}=6.63\text{В}; I_{pp}=120\text{А}$	K	A
DKP	TPSMC8.2A	GS	VS	$V_{BR}(I_T=10.0\text{мА})=7.79\dots 8.61\text{В}; V_{WM}=7.02\text{В}; I_{pp}=124\text{А}$	K	A
DLP	TPSMC9.1	GS	VS	$V_{BR}(I_T=1.0\text{мА})=8.19\dots 10.0\text{В}; V_{WM}=7.37\text{В}; I_{pp}=109\text{А}$	K	A
DMP	TPSMC9.1A	GS	VS	$V_{BR}(I_T=1.0\text{мА})=8.65\dots 9.55\text{В}; V_{WM}=7.78\text{В}; I_{pp}=112\text{А}$	K	A
DNP	TPSMC10	GS	VS	$V_{BR}(I_T=1.0\text{мА})=9.00\dots 11.0\text{В}; V_{WM}=8.10\text{В}; I_{pp}=100\text{А}$	K	A
DOP	TPSMC11	GS	VS	$V_{BR}(I_T=1.0\text{мА})=9.90\dots 12.1\text{В}; V_{WM}=8.92\text{В}; I_{pp}=92.6\text{А}$	K	A
DPP	TPSMC10A	GS	VS	$V_{BR}(I_T=1.0\text{мА})=9.50\dots 10.5\text{В}; V_{WM}=8.55\text{В}; I_{pp}=103\text{А}$	K	A

DO – 214AB (продолжение)

Код	Типономинал	Фирма	Функция	Особенности	Цоколевка	
					1	2
DRP	TPSMC11A	GS	VS	$V_{BR}(I_T=1.0mA)=10.5...11.6B; V_{WM}=9.40B; I_{pp}=96.2A$	K	A
DSP	TPSMC12	GS	VS	$V_{BR}(I_T=1.0mA)=10.8...13.2B; V_{WM}=9.72B; I_{pp}=86.7A$	K	A
DTP	TPSMC12A	GS	VS	$V_{BR}(I_T=1.0mA)=11.4...12.6B; V_{WM}=10.2B; I_{pp}=89.8A$	K	A
DUP	TPSMC13	GS	VS	$V_{BR}(I_T=1.0mA)=11.7...14.3B; V_{WM}=10.5B; I_{pp}=78.9A$	K	A
DVP	TPSMC13A	GS	VS	$V_{BR}(I_T=1.0mA)=12.4...13.7B; V_{WM}=11.1B; I_{pp}=82.4A$	K	A
DWP	TPSMC15	GS	VS	$V_{BR}(I_T=1.0mA)=13.5...16.5B; V_{WM}=12.1B; I_{pp}=68.2A$	K	A
DXP	TPSMC15A	GS	VS	$V_{BR}(I_T=1.0mA)=14.3...15.8B; V_{WM}=12.8B; I_{pp}=70.8A$	K	A
DYP	TPSMC16	GS	VS	$V_{BR}(I_T=1.0mA)=14.4...17.6B; V_{WM}=12.9B; I_{pp}=63.8A$	K	A
DZP	TPSMC16A	GS	VS	$V_{BR}(I_T=1.0mA)=15.2...16.8B; V_{WM}=13.6B; I_{pp}=66.7A$	K	A
EA	ES3A	GS	FD	$V_R=50B; I_F=3A; C_D=45\mu\Phi$	K	A
EB	ES3B	GS	FD	$V_R=100B; I_F=3A; C_D=45\mu\Phi$	K	A
EC	ES3C	GS	FD	$V_R=150B; I_F=3A; C_D=45\mu\Phi$	K	A
ED	ES3D	GS	FD	$V_R=200B; I_F=3A; C_D=45\mu\Phi$	K	A
EDP	TPSMC18	GS	VS	$V_{BR}(I_T=1.0mA)=16.2...19.8B; V_{WM}=14.5B; I_{pp}=56.6A$	K	A
EEP	TPSMC18A	GS	VS	$V_{BR}(I_T=1.0mA)=17.1...18.9B; V_{WM}=15.3B; I_{pp}=59.5A$	K	A
EFP	TPSMC20	GS	VS	$V_{BR}(I_T=1.0mA)=18.0...22.8B; V_{WM}=16.2B; I_{pp}=51.5A$	K	A
EGP	TPSMC20A	GS	VS	$V_{BR}(I_T=1.0mA)=19.0...21.0B; V_{WM}=17.1B; I_{pp}=54.2A$	K	A
EHP	TPSMC22	GS	VS	$V_{BR}(I_T=1.0mA)=19.8...24.2B; V_{WM}=17.8B; I_{pp}=47.0A$	K	A
EKP	TPSMC22A	GS	VS	$V_{BR}(I_T=1.0mA)=20.9...23.1B; V_{WM}=18.8B; I_{pp}=49.0A$	K	A
ELP	TPSMC24	GS	VS	$V_{BR}(I_T=1.0mA)=21.6...26.4B; V_{WM}=19.4B; I_{pp}=43.2A$	K	A
EMP	TPSMC24A	GS	VS	$V_{BR}(I_T=1.0mA)=22.8...25.2B; V_{WM}=20.5B; I_{pp}=45.2A$	K	A
ENP	TPSMC27	GS	VS	$V_{BR}(I_T=1.0mA)=24.3...29.7B; V_{WM}=21.8B; I_{pp}=38.4A$	K	A
EPP	TPSMC27A	GS	VS	$V_{BR}(I_T=1.0mA)=25.7...28.4B; V_{WM}=23.1B; I_{pp}=40.0A$	K	A
EQP	TPSMC30	GS	VS	$V_{BR}(I_T=1.0mA)=27.0...33.0B; V_{WM}=24.3B; I_{pp}=34.5A$	K	A
ERP	TPSMC30A	GS	VS	$V_{BR}(I_T=1.0mA)=28.5...31.5B; V_{WM}=25.6B; I_{pp}=36.2A$	K	A
ESP	TPSMC33	GS	VS	$V_{BR}(I_T=1.0mA)=29.7...36.3B; V_{WM}=26.8B; I_{pp}=31.4A$	K	A
ETP	TPSMC33A	GS	VS	$V_{BR}(I_T=1.0mA)=31.4...34.7B; V_{WM}=28.2B; I_{pp}=32.8A$	K	A
EUP	TPSMC36	GS	VS	$V_{BR}(I_T=1.0mA)=32.4...39.6B; V_{WM}=29.1B; I_{pp}=28.8A$	K	A
EVP	TPSMC36A	GS	VS	$V_{BR}(I_T=1.0mA)=34.2...37.8B; V_{WM}=30.8B; I_{pp}=30.1A$	K	A
EWP	TPSMC39	GS	VS	$V_{BR}(I_T=1.0mA)=35.1...42.9B; V_{WM}=31.6B; I_{pp}=26.6A$	K	A
EXP	TPSMC39A	GS	VS	$V_{BR}(I_T=1.0mA)=37.1...41.0B; V_{WM}=33.3B; I_{pp}=27.8A$	K	A
EYP	TPSMC43	GS	VS	$V_{BR}(I_T=1.0mA)=38.7...47.3B; V_{WM}=34.8B; I_{pp}=24.2A$	K	A
EZP	TPSMC43A	GS	VS	$V_{BR}(I_T=1.0mA)=40.9...45.2B; V_{WM}=36.8B; I_{pp}=25.3A$	K	A
GDD	SMCJ5.0	VISH	VS	$V_{BR}(I_T=10.0mA)=6.40...7.55B; V_{WM}=5.0B; I_{pp}=156.2A$	K	A
GDE	SMCJ5.0A	VISH	VS	$V_{BR}(I_T=10.0mA)=6.40...7.25B; V_{WM}=5.0B; I_{pp}=163.0A$	K	A
GDF	SMCJ6.0	VISH	VS	$V_{BR}(I_T=10.0mA)=6.67...8.45B; V_{WM}=6.0B; I_{pp}=131.6A$	K	A
GDG	SMCJ6.0A	VISH	VS	$V_{BR}(I_T=10.0mA)=6.67...7.67B; V_{WM}=6.0B; I_{pp}=145.6A$	K	A
GDH	SMCJ6.5	VISH	VS	$V_{BR}(I_T=10.0mA)=7.22...9.14B; V_{WM}=6.5B; I_{pp}=122.0A$	K	A
GDK	SMCJ6.5A	VISH	VS	$V_{BR}(I_T=10.0mA)=7.22...8.30B; V_{WM}=6.5B; I_{pp}=133.9A$	K	A
GDL	SMCJ7.0	VISH	VS	$V_{BR}(I_T=10.0mA)=7.78...9.86B; V_{WM}=7.0B; I_{pp}=112.8A$	K	A
GDM	SMCJ7.0A	VISH	VS	$V_{BR}(I_T=10.0mA)=7.78...8.95B; V_{WM}=7.0B; I_{pp}=125.0A$	K	A
GDN	SMCJ7.5	VISH	VS	$V_{BR}(I_T=1.0mA)=8.33...10.80B; V_{WM}=7.5B; I_{pp}=104.9A$	K	A
GDP	SMCJ7.5A	VISH	VS	$V_{BR}(I_T=1.0mA)=8.33...9.58B; V_{WM}=7.5B; I_{pp}=116.3A$	K	A
GDQ	SMCJ8.0	VISH	VS	$V_{BR}(I_T=1.0mA)=8.89...11.30B; V_{WM}=8.0B; I_{pp}=100.0A$	K	A
GDR	SMCJ8.0A	VISH	VS	$V_{BR}(I_T=1.0mA)=8.89...10.23B; V_{WM}=8.0B; I_{pp}=110.3A$	K	A
GDS	SMCJ8.5	VISH	VS	$V_{BR}(I_T=1.0mA)=9.44...11.92B; V_{WM}=8.5B; I_{pp}=94.3A$	K	A
GDT	SMCJ8.5A	VISH	VS	$V_{BR}(I_T=1.0mA)=9.44...10.82B; V_{WM}=8.5B; I_{pp}=104.2A$	K	A
GDU	SMCJ9.0	VISH	VS	$V_{BR}(I_T=1.0mA)=10.00...12.80B; V_{WM}=9.0B; I_{pp}=88.7A$	K	A
GDV	SMCJ9.0A	VISH	VS	$V_{BR}(I_T=1.0mA)=10.00...11.50B; V_{WM}=9.0B; I_{pp}=97.4A$	K	A
GDW	SMCJ10	VISH	VS	$V_{BR}(I_T=1.0mA)=11.10...14.10B; V_{WM}=10.0B; I_{pp}=79.8A$	K	A
GDX	SMCJ10A	VISH	VS	$V_{BR}(I_T=1.0mA)=11.10...12.80B; V_{WM}=10.0B; I_{pp}=88.2A$	K	A
GDY	SMCJ11	VISH	VS	$V_{BR}(I_T=1.0mA)=12.20...15.40B; V_{WM}=11.0B; I_{pp}=74.6A$	K	A
GDZ	SMCJ11A	VISH	VS	$V_{BR}(I_T=1.0mA)=12.20...14.40B; V_{WM}=11.0B; I_{pp}=82.4A$	K	A
GED	SMCJ12	VISH	VS	$V_{BR}(I_T=1.0mA)=13.30...16.90B; V_{WM}=12.0B; I_{pp}=68.2A$	K	A
GEE	SMCJ12A	VISH	VS	$V_{BR}(I_T=1.0mA)=13.30...15.30B; V_{WM}=12.0B; I_{pp}=75.3A$	K	A
GEF	SMCJ13	VISH	VS	$V_{BR}(I_T=1.0mA)=14.40...18.20B; V_{WM}=13.0B; I_{pp}=63.0A$	K	A
GEG	SMCJ13A	VISH	VS	$V_{BR}(I_T=1.0mA)=14.40...16.50B; V_{WM}=13.0B; I_{pp}=69.7A$	K	A

DO – 214AB (продолжение)

Код	Типономинал	Фирма	Функция	Особенности	Цоколевка	
					1	2
GEH	SMCJ14	VISH	VS	$V_{BR}(I_T=1.0mA)=15.60...19.80B; VWM=14.0B; I_{pp}=58.1A$	K	A
GEK	SMCJ14A	VISH	VS	$V_{BR}(I_T=1.0mA)=15.60...17.90B; VWM=14.0B; I_{pp}=64.7A$	K	A
GEL	SMCJ15	VISH	VS	$V_{BR}(I_T=1.0mA)=16.70...19.80B; VWM=15.0B; I_{pp}=58.1A$	K	A
GEM	SMCJ15A	VISH	VS	$V_{BR}(I_T=1.0mA)=16.70...19.20B; VWM=15.0B; I_{pp}=61.5A$	K	A
GEN	SMCJ16	VISH	VS	$V_{BR}(I_T=1.0mA)=17.80...22.60B; VWM=16.0B; I_{pp}=52.1A$	K	A
GEP	SMCJ16A	VISH	VS	$V_{BR}(I_T=1.0mA)=17.80...20.50B; VWM=16.0B; I_{pp}=57.7A$	K	A
GEQ	SMCJ17	VISH	VS	$V_{BR}(I_T=1.0mA)=18.90...23.90B; VWM=17.0B; I_{pp}=49.2A$	K	A
GER	SMCJ17A	VISH	VS	$V_{BR}(I_T=1.0mA)=18.90...21.70B; VWM=17.0B; I_{pp}=53.3A$	K	A
GES	SMCJ18	VISH	VS	$V_{BR}(I_T=1.0mA)=20.00...25.30B; VWM=18.0B; I_{pp}=46.6A$	K	A
GET	SMCJ18A	VISH	VS	$V_{BR}(I_T=1.0mA)=20.00...23.30B; VWM=18.0B; I_{pp}=51.4A$	K	A
GEU	SMCJ20	VISH	VS	$V_{BR}(I_T=1.0mA)=22.20...28.10B; VWM=20.0B; I_{pp}=41.9A$	K	A
GEV	SMCJ20A	VISH	VS	$V_{BR}(I_T=1.0mA)=22.20...25.50B; VWM=20.0B; I_{pp}=46.3A$	K	A
GEW	SMCJ22	VISH	VS	$V_{BR}(I_T=1.0mA)=24.40...30.90B; VWM=22.0B; I_{pp}=38.1A$	K	A
GEX	SMCJ22A	VISH	VS	$V_{BR}(I_T=1.0mA)=24.40...28.00B; VWM=22.0B; I_{pp}=42.2A$	K	A
GEY	SMCJ24	VISH	VS	$V_{BR}(I_T=1.0mA)=26.70...33.80B; VWM=24.0B; I_{pp}=34.9A$	K	A
GEZ	SMCJ24A	VISH	VS	$V_{BR}(I_T=1.0mA)=26.70...30.70B; VWM=24.0B; I_{pp}=38.6A$	K	A
GFD	SMCJ26	VISH	VS	$V_{BR}(I_T=1.0mA)=28.90...36.80B; VWM=26.0B; I_{pp}=32.2A$	K	A
GFE	SMCJ26A	VISH	VS	$V_{BR}(I_T=1.0mA)=28.90...33.20B; VWM=26.0B; I_{pp}=35.6A$	K	A
GFF	SMCJ28	VISH	VS	$V_{BR}(I_T=1.0mA)=31.10...39.40B; VWM=28.0B; I_{pp}=30.0A$	K	A
GFG	SMCJ28A	VISH	VS	$V_{BR}(I_T=1.0mA)=31.10...35.80B; VWM=28.0B; I_{pp}=33.0A$	K	A
GFH	SMCJ30	VISH	VS	$V_{BR}(I_T=1.0mA)=33.30...42.40B; VWM=30.0B; I_{pp}=28.0A$	K	A
GFK	SMCJ30A	VISH	VS	$V_{BR}(I_T=1.0mA)=33.30...38.30B; VWM=30.0B; I_{pp}=31.0A$	K	A
GFL	SMCJ33	VISH	VS	$V_{BR}(I_T=1.0mA)=36.70...46.90B; VWM=33.0B; I_{pp}=25.2A$	K	A
GFM	SMCJ33A	VISH	VS	$V_{BR}(I_T=1.0mA)=36.70...42.20B; VWM=33.0B; I_{pp}=28.1A$	K	A
GFN	SMCJ36	VISH	VS	$V_{BR}(I_T=1.0mA)=40.00...50.70B; VWM=36.0B; I_{pp}=23.3A$	K	A
GFP	SMCJ36A	VISH	VS	$V_{BR}(I_T=1.0mA)=40.00...46.00B; VWM=36.0B; I_{pp}=25.8A$	K	A
GFQ	SMCJ40	VISH	VS	$V_{BR}(I_T=1.0mA)=44.40...56.30B; VWM=40.0B; I_{pp}=21.0A$	K	A
GFR	SMCJ40A	VISH	VS	$V_{BR}(I_T=1.0mA)=44.40...51.10B; VWM=40.0B; I_{pp}=23.2A$	K	A
GFS	SMCJ43	VISH	VS	$V_{BR}(I_T=1.0mA)=47.80...60.50B; VWM=43.0B; I_{pp}=19.6A$	K	A
GFT	SMCJ43A	VISH	VS	$V_{BR}(I_T=1.0mA)=47.80...54.90B; VWM=43.0B; I_{pp}=21.6A$	K	A
GFU	SMCJ45	VISH	VS	$V_{BR}(I_T=1.0mA)=50.00...63.30B; VWM=45.0B; I_{pp}=18.7A$	K	A
GFV	SMCJ45A	VISH	VS	$V_{BR}(I_T=1.0mA)=50.00...57.50B; VWM=45.0B; I_{pp}=20.6A$	K	A
GFW	SMCJ48	VISH	VS	$V_{BR}(I_T=1.0mA)=53.30...67.50B; VWM=48.0B; I_{pp}=17.5A$	K	A
GFX	SMCJ48A	VISH	VS	$V_{BR}(I_T=1.0mA)=53.30...61.30B; VWM=48.0B; I_{pp}=19.4A$	K	A
GFY	SMCJ51	VISH	VS	$V_{BR}(I_T=1.0mA)=56.70...71.80B; VWM=51.0B; I_{pp}=16.5A$	K	A
GFZ	SMCJ51A	VISH	VS	$V_{BR}(I_T=1.0mA)=56.70...65.20B; VWM=51.0B; I_{pp}=18.2A$	K	A
GGD	SMCJ54	VISH	VS	$V_{BR}(I_T=1.0mA)=60.00...76.00B; VWM=54.0B; I_{pp}=15.6A$	K	A
GGE	SMCJ54A	VISH	VS	$V_{BR}(I_T=1.0mA)=60.00...69.00B; VWM=54.0B; I_{pp}=17.2A$	K	A
GGF	SMCJ58	VISH	VS	$V_{BR}(I_T=1.0mA)=64.40...81.60B; VWM=58.0B; I_{pp}=14.6A$	K	A
GGG	SMCJ58A	VISH	VS	$V_{BR}(I_T=1.0mA)=64.40...74.60B; VWM=58.0B; I_{pp}=16.0A$	K	A
GGH	SMCJ60	VISH	VS	$V_{BR}(I_T=1.0mA)=66.70...84.50B; VWM=60.0B; I_{pp}=14.0A$	K	A
GGK	SMCJ60A	VISH	VS	$V_{BR}(I_T=1.0mA)=66.70...76.70B; VWM=60.0B; I_{pp}=15.A$	K	A
GGL	SMCJ64	VISH	VS	$V_{BR}(I_T=1.0mA)=71.10...90.10B; VWM=64.0B; I_{pp}=13.2A$	K	A
GGM	SMCJ64A	VISH	VS	$V_{BR}(I_T=1.0mA)=71.10...81.80B; VWM=64.0B; I_{pp}=14.6A$	K	A
GGN	SMCJ70	VISH	VS	$V_{BR}(I_T=1.0mA)=77.80...98.60B; VWM=70.0B; I_{pp}=12.0A$	K	A
GGP	SMCJ70A	VISH	VS	$V_{BR}(I_T=1.0mA)=77.80...89.50B; VWM=70.0B; I_{pp}=13.3A$	K	A
GGQ	SMCJ75	VISH	VS	$V_{BR}(I_T=1.0mA)=83.30...106.00B; VWM=75.0B; I_{pp}=11.2A$	K	A
GGR	SMCJ75A	VISH	VS	$V_{BR}(I_T=1.0mA)=83.30...95.80B; VWM=75.0B; I_{pp}=12.4A$	K	A
GGS	SMCJ78	VISH	VS	$V_{BR}(I_T=1.0mA)=86.70...110.00B; VWM=78.0B; I_{pp}=10.8A$	K	A
GGT	SMCJ78A	VISH	VS	$V_{BR}(I_T=1.0mA)=86.70...99.70B; VWM=78.0B; I_{pp}=11.4A$	K	A
GGU	SMCJ85	VISH	VS	$V_{BR}(I_T=1.0mA)=94.40...119.20B; VWM=85.0B; I_{pp}=9.9A$	K	A
GGV	SMCJ85A	VISH	VS	$V_{BR}(I_T=1.0mA)=94.40...108.20B; VWM=85.0B; I_{pp}=10.4A$	K	A
GGW	SMCJ90	VISH	VS	$V_{BR}(I_T=1.0mA)=100.00...126.50; VWM=90.0B; I_{pp}=9.4A$	K	A
GGX	SMCJ90A	VISH	VS	$V_{BR}(I_T=1.0mA)=100.00...115.50; VWM=90.0B; I_{pp}=10.3A$	K	A

DO – 214AB (продолжение)

Код	Типоминал	Фирма	Функция	Особенности	Цоколевка	
					1	2
GGY	SMCJ100	VISH	VS	$V_{BR} (I_T=1.0mA)=111.00...141.00$; $V_{WM}=100.0B$; $I_{pp}=8.4A$	K	A
GGZ	SMCJ100A	VISH	VS	$V_{BR} (I_T=1.0mA)=111.00...128.00$; $V_{WM}=100.0B$; $I_{pp}=9.3A$	K	A
GHD	SMCJ110	VISH	VS	$V_{BR} (I_T=1.0mA)=122.00...154.50$; $V_{WM}=110.0B$; $I_{pp}=7.7A$	K	A
GHE	SMCJ110A	VISH	VS	$V_{BR} (I_T=1.0mA)=122.00...140.50$; $V_{WM}=110.0B$; $I_{pp}=8.4A$	K	A
GHF	SMCJ120	VISH	VS	$V_{BR} (I_T=1.0mA)=133.00...169.00$; $V_{WM}=120.0B$; $I_{pp}=7.0A$	K	A
GHG	SMCJ120A	VISH	VS	$V_{BR} (I_T=1.0mA)=133.00...153.00$; $V_{WM}=120.0B$; $I_{pp}=7.9A$	K	A
GHH	SMCJ130	VISH	VS	$V_{BR} (I_T=1.0mA)=144.00...182.50$; $V_{WM}=130.0B$; $I_{pp}=6.5A$	K	A
GHK	SMCJ130A	VISH	VS	$V_{BR} (I_T=1.0mA)=144.00...165.00$; $V_{WM}=130.0B$; $I_{pp}=7.2A$	K	A
GHL	SMCJ150	VISH	VS	$V_{BR} (I_T=1.0mA)=167.00...211.50$; $V_{WM}=150.0B$; $I_{pp}=5.6A$	K	A
GHM	SMCJ150A	VISH	VS	$V_{BR} (I_T=1.0mA)=167.00...192.50$; $V_{WM}=150.0B$; $I_{pp}=6.2A$	K	A
GHN	SMCJ160	VISH	VS	$V_{BR} (I_T=1.0mA)=178.00...226.00$; $V_{WM}=160.0B$; $I_{pp}=5.2A$	K	A
GHP	SMCJ160A	VISH	VS	$V_{BR} (I_T=1.0mA)=178.00...205.00$; $V_{WM}=160.0B$; $I_{pp}=5.8A$	K	A
GHQ	SMCJ170	VISH	VS	$V_{BR} (I_T=1.0mA)=189.00...239.50$; $V_{WM}=170.0B$; $I_{pp}=4.9A$	K	A
GHR	SMCJ170A	VISH	VS	$V_{BR} (I_T=1.0mA)=189.00...217.50$; $V_{WM}=170.0B$; $I_{pp}=5.5A$	K	A

DO-214AC SMA

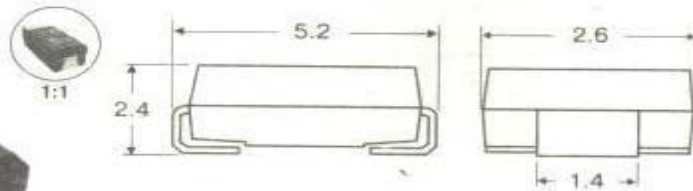
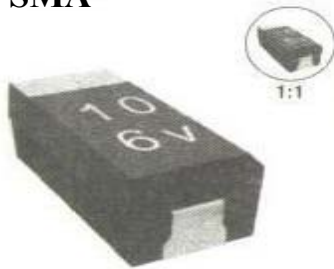

Первый вывод полярных приборов маркируется точкой, выемкой или полосой у катода

Код	Типономинал	Фирма	Функция	Особенности	Цоколевка	
					1	2
10	SML 4740	GS	DZ	$V_z(I_z=25.0\text{mA})=10\text{B}; Z_{\text{ZT}}=7.0\text{Om}$	K	A
11	SML 4741	GS	DZ	$V_z(I_z=23.0\text{mA})=11\text{B}; Z_{\text{ZT}}=8.0\text{Om}$	K	A
12	SML 4742	GS	DZ	$V_z(I_z=21.0\text{mA})=12\text{B}; Z_{\text{ZT}}=9.0\text{Om}$	K	A
13	SML 4743	GS	DZ	$V_z(I_z=19.0\text{mA})=13\text{B}; Z_{\text{ZT}}=10.0\text{Om}$	K	A
15	SML 4744	GS	DZ	$V_z(I_z=17.0\text{mA})=15\text{B}; Z_{\text{ZT}}=14.0\text{Om}$	K	A
16	SML 4745	GS	DZ	$V_z(I_z=15.5\text{mA})=16\text{B}; Z_{\text{ZT}}=16.0\text{Om}$	K	A
18	SML 4746	GS	DZ	$V_z(I_z=14.0\text{mA})=18\text{B}; Z_{\text{ZT}}=20.0\text{Om}$	K	A
20	SML 4747	GS	DZ	$V_z(I_z=12.5\text{mA})=20\text{B}; Z_{\text{ZT}}=22.0\text{Om}$	K	A
22	SML 4748	GS	DZ	$V_z(I_z=11.5\text{mA})=22\text{B}; Z_{\text{ZT}}=23.0\text{Om}$	K	A
24	SML 4749	GS	DZ	$V_z(I_z=10.5\text{mA})=24\text{B}; Z_{\text{ZT}}=25.0\text{Om}$	K	A
27	SML 4750	GS	DZ	$V_z(I_z=9.5\text{mA})=27\text{B}; Z_{\text{ZT}}=35.0\text{Om}$	K	A
30	SML 4751	GS	DZ	$V_z(I_z=8.5\text{mA})=30\text{B}; Z_{\text{ZT}}=40.0\text{Om}$	K	A
33	SML 4752	GS	DZ	$V_z(I_z=7.5\text{mA})=33\text{B}; Z_{\text{ZT}}=45.0\text{Om}$	K	A
36	SML 4753	GS	DZ	$V_z(I_z=7.0\text{mA})=36\text{B}; Z_{\text{ZT}}=50.0\text{Om}$	K	A
39	SML 4754	GS	DZ	$V_z(I_z=6.5\text{mA})=39\text{B}; Z_{\text{ZT}}=60.0\text{Om}$	K	A
43	SML 4755	GS	DZ	$V_z(I_z=6.0\text{mA})=43\text{B}; Z_{\text{ZT}}=70.0\text{Om}$	K	A
47	SML 4756	GS	DZ	$V_z(I_z=5.5\text{mA})=47\text{B}; Z_{\text{ZT}}=80.0\text{Om}$	K	A
51	SML 4757	GS	DZ	$V_z(I_z=5.0\text{mA})=51\text{B}; Z_{\text{ZT}}=95.0\text{Om}$	K	A
56	SML 4758	GS	DZ	$V_z(I_z=4.5\text{mA})=56\text{B}; Z_{\text{ZT}}=110.0\text{Om}$	K	A
62	SML 4759	GS	DZ	$V_z(I_z=4.0\text{mA})=62\text{B}; Z_{\text{ZT}}=125.0\text{Om}$	K	A
68	SML 4735	GS	DZ	$V_z(I_z=3.7\text{mA})=68\text{B}; Z_{\text{ZT}}=150.0\text{Om}$	K	A
6P2	SML 4736	GS	DZ	$V_z(I_z=41.0\text{mA})=6.2\text{B}; Z_{\text{ZT}}=2.0\text{Om}$	K	A
6P8	SML 4736	GS	DZ	$V_z(I_z=37.0\text{mA})=6.8\text{B}; Z_{\text{ZT}}=3.5\text{Om}$	K	A
75	SML 4761	GS	DZ	$V_z(I_z=3.3\text{mA})=75\text{B}; Z_{\text{ZT}}=175.0\text{Om}$	K	A
7P5	SML 4737	GS	DZ	$V_z(I_z=34.0\text{mA})=7.5\text{B}; Z_{\text{ZT}}=4.0\text{Om}$	K	A
82	SML 4762	GS	DZ	$V_z(I_z=3.0\text{mA})=82\text{B}; Z_{\text{ZT}}=200.0\text{Om}$	K	A
8P2	SML 4738	GS	DZ	$V_z(I_z=31.0\text{mA})=8.2\text{B}; Z_{\text{ZT}}=4.5\text{Om}$	K	A
91	SML 4763	GS	DZ	$V_z(I_z=2.0\text{mA})=91\text{B}; Z_{\text{ZT}}=250.0\text{Om}$	K	A
9P1	SML 4739	GS	DZ	$V_z(I_z=28.0\text{mA})=9.1\text{B}; Z_{\text{ZT}}=5.0\text{Om}$	K	A
ADP	TPSMA6.8	GS	VS	$V_{\text{BR}}(I_T=10.0\text{mA})=6.12...7.48\text{B}; V_{\text{WM}}=5.50\text{B}; I_{\text{pp}}=37.0\text{A}$	K	A
AEP	TPSMA6.8A	GS	VS	$V_{\text{BR}}(I_T=10.0\text{mA})=6.45...7.14\text{B}; V_{\text{WM}}=5.80\text{B}; I_{\text{pp}}=38.1\text{A}$	K	A
AFP	TPSMA7.5	GS	VS	$V_{\text{BR}}(I_T=10.0\text{mA})=6.75...8.25\text{B}; V_{\text{WM}}=6.05\text{B}; I_{\text{pp}}=34.2\text{A}$	K	A
AGP	TPSMA7.5A	GS	VS	$V_{\text{BR}}(I_T=10.0\text{mA})=7.13...7.88\text{B}; V_{\text{WM}}=6.40\text{B}; I_{\text{pp}}=35.4\text{A}$	K	A
AHP	TPSMA8.2	GS	VS	$V_{\text{BR}}(I_T=10.0\text{mA})=7.38...9.02\text{B}; V_{\text{WM}}=6.63\text{B}; I_{\text{pp}}=32.0\text{A}$	K	A
AKP	TPSMA8.2A	GS	VS	$V_{\text{BR}}(I_T=10.0\text{mA})=7.79...8.61\text{B}; V_{\text{WM}}=7.02\text{B}; I_{\text{pp}}=33.1\text{A}$	K	A
ALP	TPSMA9.1	GS	VS	$V_{\text{BR}}(I_T=1.0\text{mA})=8.19...10.00\text{B}; V_{\text{WM}}=7.370\text{B}; I_{\text{pp}}=29.0\text{A}$	K	A
AMP	TPSMA9.1A	GS	VS	$V_{\text{BR}}(I_T=1.0\text{mA})=8.65...9.55\text{B}; V_{\text{WM}}=7.78\text{B}; I_{\text{pp}}=29.9\text{A}$	K	A
ANP	TPSMA10	GS	VS	$V_{\text{BR}}(I_T=1.0\text{mA})=9.00...11.00\text{B}; V_{\text{WM}}=8.10\text{B}; I_{\text{pp}}=26.7\text{A}$	K	A
APP	TPSMA10A	GS	VS	$V_{\text{BR}}(I_T=1.0\text{mA})=9.50...10.50\text{B}; V_{\text{WM}}=8.65\text{B}; I_{\text{pp}}=27.6\text{A}$	K	A
AQP	TPSMA11	GS	VS	$V_{\text{BR}}(I_T=1.0\text{mA})=9.90...12.10\text{B}; V_{\text{WM}}=8.92\text{B}; I_{\text{pp}}=24.7\text{A}$	K	A
ARP	TPSMA11A	GS	VS	$V_{\text{BR}}(I_T=1.0\text{mA})=10.50...11.60\text{B}; V_{\text{WM}}=9.40\text{B}; I_{\text{pp}}=25.6\text{A}$	K	A
AWP	TPSMA15	GS	VS	$V_{\text{BR}}(I_T=1.0\text{mA})=13.50...16.30\text{B}; V_{\text{WM}}=12.10\text{B}; I_{\text{pp}}=18.2\text{A}$	K	A

DO-214AC (продолжение)

Код	Типономинал	Фирма	Функция	Особенности	Цоколевка	
					1	2
AXP	TPSMA15A	GS	VS	$V_{BR}(I_T=1.0mA)=14.30...15.80B$; $V_{WM}=12.80B; I_{pp}=18.9A$	K	A
AYP	TPSMA16	GS	VS	$V_{BR}(I_T=1.0mA)=14.40...17.60B$; $V_{WM}=12.90B; I_{pp}=17.0A$	K	A
AZP	TPSMA16A	GS	VS	$V_{BR}(I_T=1.0mA)=15.20...16.80B$; $V_{WM}=13.60B; I_{pp}=37.8A$	K	A
BDP	TPSMA18	GS	VS	$V_{BR}(I_T=1.0mA)=16.20...19.80B$; $V_{WM}=14.50B; I_{pp}=151A$	K	A
BEP	TPSMA18A	GS	VS	$V_{BR}(I_T=1.0mA)=17.10...18.90B$; $V_{WM}=15.30B; I_{pp}=15.9A$	K	A
BFP	TPSMA20	GS	VS	$V_{BR}(I_T=1.0mA)=18.00...22.00B$; $V_{WM}=16.20B; I_{pp}=13.7A$	K	A
BGP	TPSMA20A	GS	VS	$V_{BR}(I_T=1.0mA)=19.00...21.00B$; $V_{WM}=17.10B; I_{pp}=14.4A$	K	A
BHP	TPSMA22	GS	VS	$V_{BR}(I_T=1.0mA)=19.80...24.20B$; $V_{WM}=17.80B; I_{pp}=12.5A$	K	A
BKP	TPSMA22A	GS	VS	$V_{BR}(I_T=1.0mA)=20.90...23.10B; V_{WM}=18.80B; I_{pp}=13.1A$	K	A
BLP	TPSMA24	GS	VS	$V_{BR}(I_T=1.0mA)=21.60...26.40B; V_{WM}=19.40B; I_{pp}=11.5A$	K	A
BMP	TPSMA24A	GS	VS	$V_{BR}(I_T=1.0mA)=22.80...25.20B; V_{WM}=20.50B; I_{pp}=12.0A$	K	A
BNP	TPSMA27	GS	VS	$V_{BR}(I_T=1.0mA)=24.30...29.70B; V_{WM}=21.80B; I_{pp}=10.2A$	K	A
BOP	TPSMA30	GS	VS	$V_{BR}(I_T=1.0mA)=27.00...33.00B; V_{WM}=24.30B; I_{pp}=9.2A$	K	A
BPP	TPSMA27A	GS	VS	$V_{BR}(I_T=1.0mA)=25.70...28.40B; V_{WM}=23.10B; I_{pp}=10.7A$	K	A
BRP	TPSMA30A	GS	VS	$V_{BR}(I_T=1.0mA)=28.50...31.50B; V_{WM}=25.60B; I_{pp}=9.7A$	K	A
BSP	TPSMA33	GS	VS	$V_{BR}(I_T=1.0mA)=29.70...36.30B; V_{WM}=26.80B; I_{pp}=8.4A$	K	A
BTP	TPSMA33A	GS	VS	$V_{BR}(I_T=1.0mA)=31.40...34.70B; V_{WM}=28.20B; I_{pp}=8.8A$	K	A
BUP	TPSMA36	GS	VS	$V_{BR}(I_T=1.0mA)=32.40...39.60B; V_{WM}=29.10B; I_{pp}=7.7A$	K	A
BVP	TPSMA36A	GS	VS	$V_{BR}(I_T=1.0mA)=34.20...37.80B; V_{WM}=30.80B; I_{pp}=8.0A$	K	A
BWP	TPSMA39	GS	VS	$V_{BR}(I_T=1.0mA)=35.10...42.90B; V_{WM}=31.60B; I_{pp}=7.1A$	K	A
BXP	TPSMA39A	GS	VS	$V_{BR}(I_T=1.0mA)=37.10...41.00B; V_{WM}=33.30B; I_{pp}=7.4A$	K	A
BYP	TPSMA43	GS	VS	$V_{BR}(I_T=1.0mA)=38.70...47.30B; V_{WM}=34.80B; I_{pp}=6.5A$	K	A
BZP	TPSMA43A	GS	VS	$V_{BR}(I_T=1.0mA)=40.90...45.20B; V_{WM}=36.80B; I_{pp}=6.7A$	K	A
EA	ES1A	GS	VS	$V_R=50B; I_F=1A; C_D=7пФ$	K	A
EB	ES1B	GS	VS	$V_R=100B; I_F=1A; C_D=7пФ$	K	A
EC	ES1C	GS	VS	$V_R=150B; I_F=1A; C_D=7пФ$	K	A
ED	ES1D	GS	VS	$V_R=200B; I_F=1A; C_D=7пФ$	K	A
HD	SMAJ5.0	VISH	VS	$V_{BR}(I_T=10.0mA)=6.40...7.30B; V_{WM}=9.6B; I_{pp}=41.6A$	K	A
HE	SMAJ5.0A	VISH	VS	$V_{BR}(I_T=10.0mA)=6.4...7.0B; V_{WM}=9.2B; I_{pp}=43.5A$	K	A
HF	SMAJ6.0	VISH	VS	$V_{BR}(I_T=10.0mA)=6.67...8.15B; V_{WM}=11.4B; I_{pp}=35.1A$	K	A
HG	SMAJ6.0A	VISH	VS	$V_{BR}(I_T=10.0mA)=6.67...7.37B; V_{WM}=10.3B; I_{pp}=38.8A$	K	A
HH	SMAJ6.5	VISH	VS	$V_{BR}(I_T=10.0mA)=7.22...8.82B; V_{WM}=12.3B; I_{pp}=32.5A$	K	A
HK	SMAJ6.5A	VISH	VS	$V_{BR}(I_T=10.0mA)=7.22...7.98B; V_{WM}=11.2B; I_{pp}=35.7A$	K	A
HL	SMAJ7.0	VISH	VS	$V_{BR}(I_T=10.0mA)=7.78...9.51B; V_{WM}=13.3B; I_{pp}=30.1A$	K	A
HM	SMAJ7.0A	VISH	VS	$V_{BR}(I_T=10.0mA)=7.78...8.60B; V_{WM}=12.0B; I_{pp}=33.3A$	K	A
HN	SMAJ7.5	VISH	VS	$V_{BR}(I_T=1.0mA)=8.33...10.3B; V_{WM}=14.3B; I_{pp}=28.0A$	K	A
HP	SMAJ7.5A	VISH	VS	$V_{BR}(I_T=1.0mA)=8.33...9.21B; V_{WM}=12.9B; I_{pp}=31.0A$	K	A
HQ	SMAJ8.0	VISH	VS	$V_{BR}(I_T=1.0mA)=8.89...10.9B; V_{WM}=15.0B; I_{pp}=26.5A$	K	A
HR	SMAJ8.0A	VISH	VS	$V_{BR}(I_T=1.0mA)=8.89...9.83B; V_{WM}=13.6B; I_{pp}=29.4A$	K	A
HS	SMAJ8.5	VISH	VS	$V_{BR}(I_T=1.0mA)=9.44...11.5B; V_{WM}=15.9B; I_{pp}=25.1A$	K	A
HT	SMAJ8.5A	VISH	VS	$V_{BR}(I_T=1.0mA)=9.44...10.4B; V_{WM}=14.4B; I_{pp}=27.7A$	K	A
HU	SMAJ9.0	VISH	VS	$V_{BR}(I_T=1.0mA)=10.0...12.2B; V_{WM}=16.9B; I_{pp}=23.6A$	K	A
HV	SMAJ9.0A	VISH	VS	$V_{BR}(I_T=1.0mA)=10.0...11.1B; V_{WM}=15.4B; I_{pp}=26.0A$	K	A
HW	SMAJ10	VISH	VS	$V_{BR}(I_T=1.0mA)=11.0...13.6B; V_{WM}=18.8B; I_{pp}=21.2A$	K	A
HX	SMAJ10A	VISH	VS	$V_{BR}(I_T=1.0mA)=11.0...12.3B; V_{WM}=17.0B; I_{pp}=23.5A$	K	A

DO-214AC (продолжение)

Код	Типономинал	Фирма	Функция	Особенности	Цоколевка	
					1	2
IP	SMAJ16A	VISH	VS	$V_{BR}(I_T=1.0mA)=17.8...19.7B; V_{WM}=26.0B; I_{pp}=15.3A$	K	A
IQ	SMAJ17	VISH	VS	$V_{BR}(I_T=1.0mA)=18.9...23.1B; V_{WM}=30.5B; I_{pp}=13.1A$	K	A
IR	SMAJ17A	VISH	VS	$V_{BR}(I_T=1.0mA)=18.9...20.9B; V_{WM}=27.6B; I_{pp}=14.5A$	K	A
IS	SMAJ18	VISH	VS	$V_{BR}(I_T=1.0mA)=20.0...24.4B; V_{WM}=32.2B; I_{pp}=12.4A$	K	A
IT	SMAJ18A	VISH	VS	$V_{BR}(I_T=1.0mA)=20.0...22.1B; V_{WM}=29.2B; I_{pp}=13.7A$	K	A
IU	SMAJ20	VISH	VS	$V_{BR}(I_T=1.0mA)=22.2...27.1B; V_{WM}=35.8B; I_{pp}=11.1A$	K	A
IV	SMAJ20A	VISH	VS	$V_{BR}(I_T=1.0mA)=22.2...24.5B; V_{WM}=32.4B; I_{pp}=12.3A$	K	A
IW	SMAJ22	VISH	VS	$V_{BR}(I_T=1.0mA)=24.4...29.8B; V_{WM}=39.4B; I_{pp}=10.1A$	K	A
IX	SMAJ22A	VISH	VS	$V_{BR}(I_T=1.0mA)=24.4...26.9B; V_{WM}=35.5B; I_{pp}=11.2A$	K	A
IY	SMAJ24	VISH	VS	$V_{BR}(I_T=1.0mA)=26.7...32.6B; V_{WM}=43.0B; I_{pp}=9.3A$	K	A
IZ	SMAJ24A	VISH	VS	$V_{BR}(I_T=1.0mA)=26.7...29.5B; V_{WM}=38.9B; I_{pp}=10.3A$	K	A
JD	SMAJ26	VISH	VS	$V_{BR}(I_T=1.0mA)=28.9...31.9B; V_{WM}=46.6B; I_{pp}=8.6A$	K	A
JE	SMAJ26A	VISH	VS	$V_{BR}(I_T=1.0mA)=28.9...25.3B; V_{WM}=42.1B; I_{pp}=9.5A$	K	A
JF	SMAJ28	VISH	VS	$V_{BR}(I_T=1.0mA)=31.1...38.0B; V_{WM}=50.0B; I_{pp}=8.0A$	K	A
JG	SMAJ28A	VISH	VS	$V_{BR}(I_T=1.0mA)=31.1...34.4B; V_{WM}=45.4B; I_{pp}=8.8A$	K	A
JH	SMAJ30	VISH	VS	$V_{BR}(I_T=1.0mA)=33.3...40.7B; V_{WM}=53.5B; I_{pp}=7.5A$	K	A
JK	SMAJ30A	VISH	VS	$V_{BR}(I_T=1.0mA)=33.3...36.8B; V_{WM}=48.4B; I_{pp}=8.3A$	K	A
JL	SMAJ33	VISH	VS	$V_{BR}(I_T=1.0mA)=36.7...44.9B; V_{WM}=59.0B; I_{pp}=6.8A$	K	A
JM	SMAJ33A	VISH	VS	$V_{BR}(I_T=1.0mA)=36.7...40.6B; V_{WM}=53.3B; I_{pp}=7.5A$	K	A
JN	SMAJ36	VISH	VS	$V_{BR}(I_T=1.0mA)=40.0...48.9B; V_{WM}=64.3B; I_{pp}=6.2A$	K	A
JP	SMAJ36A	VISH	VS	$V_{BR}(I_T=1.0mA)=40.0...44.2B; V_{WM}=58.1B; I_{pp}=6.9A$	K	A
JQ	SMAJ40	VISH	VS	$V_{BR}(I_T=1.0mA)=44.4...54.3B; V_{WM}=71.4B; I_{pp}=5.6A$	K	A
JR	SMAJ40A	VISH	VS	$V_{BR}(I_T=1.0mA)=44.4...49.1B; V_{WM}=64.5B; I_{pp}=6.2A$	K	A
JS	SMAJ43	VISH	VS	$V_{BR}(I_T=1.0mA)=47.8...58.4B; V_{WM}=76.7B; I_{pp}=5.2A$	K	A
JT	SMAJ43A	VISH	VS	$V_{BR}(I_T=1.0mA)=47.8...52.8B; V_{WM}=69.4B; I_{pp}=5.7A$	K	A
JU	SMAJ45	VISH	VS	$V_{BR}(I_T=1.0mA)=50.0...61.1B; V_{WM}=80.3B; I_{pp}=5.0A$	K	A
JV	SMAJ45A	VISH	VS	$V_{BR}(I_T=1.0mA)=50.0...55.3B; V_{WM}=72.7B; I_{pp}=5.5A$	K	A
JW	SMAJ48	VISH	VS	$V_{BR}(I_T=1.0mA)=53.3...65.1B; V_{WM}=85.5B; I_{pp}=4.7A$	K	A
JX	SMAJ48A	VISH	VS	$V_{BR}(I_T=1.0mA)=53.3...58.9B; V_{WM}=77.4B; I_{pp}=5.2A$	K	A
JY	SMAJ51	VISH	VS	$V_{BR}(I_T=1.0mA)=56.7...69.3B; V_{WM}=91.1B; I_{pp}=4.4A$	K	A
JZ	SMAJ51A	VISH	VS	$V_{BR}(I_T=1.0mA)=56.7...62.7B; V_{WM}=82.4B; I_{pp}=4.9A$	K	A
RD	SMAJ54	VISH	VS	$V_{BR}(I_T=1.0mA)=60.0...73.3B; V_{WM}=96.3B; I_{pp}=4.2A$	K	A
RE	SMAJ54A	VISH	VS	$V_{BR}(I_T=1.0mA)=60.0...66.3B; V_{WM}=87.1B; I_{pp}=4.6A$	K	A
RF	SMAJ58	VISH	VS	$V_{BR}(I_T=1.0mA)=64.4...78.7B; V_{WM}=103B; I_{pp}=3.9A$	K	A
RG	SMAJ58A	VISH	VS	$V_{BR}(I_T=1.0mA)=64.4...71.2B; V_{WM}=93.6B; I_{pp}=4.3A$	K	A
RH	SMAJ60	VISH	VS	$V_{BR}(I_T=1.0mA)=66.7...81.5B; V_{WM}=107B; I_{pp}=3.7A$	K	A
RK	SMAJ60A	VISH	VS	$V_{BR}(I_T=1.0mA)=66...73.7B; V_{WM}=96.8B; I_{pp}=4.1A$	K	A
RL	SMAJ64	VISH	VS	$V_{BR}(I_T=1.0mA)=71.1...86.4B; V_{WM}=114B; I_{pp}=3.5A$	K	A
RM	SMAJ64A	VISH	VS	$V_{BR}(I_T=1.0mA)=71.1...78.6B; V_{WM}=103B; I_{pp}=3.9A$	K	A
RN	SMAJ70	VISH	VS	$V_{BR}(I_T=1.0mA)=77.8...95.1B; V_{WM}=125B; I_{pp}=3.2A$	K	A
RP	SMAJ70A	VISH	VS	$V_{BR}(I_T=1.0mA)=77.8...86.0B; V_{WM}=113B; I_{pp}=3.5A$	K	A
RQ	SMAJ75	VISH	VS	$V_{BR}(I_T=1.0mA)=83.3...102B; V_{WM}=134B; I_{pp}=3.0A$	K	A
RR	SMAJ75A	VISH	VS	$V_{BR}(I_T=1.0mA)=83.3...92.1B; V_{WM}=121B; I_{pp}=3.3A$	K	A
RS	SMAJ78	VISH	VS	$V_{BR}(I_T=1.0mA)=86.7...106B; V_{WM}=139B; I_{pp}=2.9A$	K	A
RT	SMAJ78A	VISH	VS	$V_{BR}(I_T=1.0mA)=86.7...95.8B; V_{WM}=126B; I_{pp}=2.2A$	K	A
RU	SMAJ85	VISH	VS	$V_{BR}(I_T=1.0mA)=94.4...115B; V_{WM}=151B; I_{pp}=2.6A$	K	A
RV	SMAJ85A	VISH	VS	$V_{BR}(I_T=1.0mA)=94.4...104B; V_{WM}=137B; I_{pp}=2.9A$	K	A
RW	SMAJ90	VISH	VS	$V_{BR}(I_T=1.0mA)=100...122B; V_{WM}=160B; I_{pp}=2.5A$	K	A
RX	SMAJ90A	VISH	VS	$V_{BR}(I_T=1.0mA)=100...111B; V_{WM}=146B; I_{pp}=2.7A$	K	A
RY	SMAJ100	VISH	VS	$V_{BR}(I_T=1.0mA)=111...136B; V_{WM}=179B; I_{pp}=2.2A$	K	A
RZ	SMAJ100A	VISH	VS	$V_{BR}(I_T=1.0mA)=111...123B; V_{WM}=162B; I_{pp}=2.5A$	K	A
SD	SMAJ110	VISH	VS	$V_{BR}(I_T=1.0mA)=122...149B; V_{WM}=196B; I_{pp}=2.0A$	K	A
SE	SMAJ110A	VISH	VS	$V_{BR}(I_T=1.0mA)=122...135B; V_{WM}=177B; I_{pp}=2.3A$	K	A

DO-214AC (продолжение)

Код	Типономинал	Фирма	Функция	Особенности	Цоколевка	
					1	2
SF	SMAJ120	VISH	VS	$V_{BR}(I_T=1.0mA)=133...163B; V_{WM}=214B; I_{pp}=1.9A$	K	A
SG	SMAJ120A	VISH	VS	$V_{BR}(I_T=1.0mA)=133...147B; V_{WM}=193B; I_{pp}=2.0A$	K	A
SH	SMAJ130	VISH	VS	$V_{BR}(I_T=1.0mA)=144...176B; V_{WM}=231B; I_{pp}=1.7A$	K	A
SK	SMAJ130A	VISH	VS	$V_{BR}(I_T=1.0mA)=144...159B; V_{WM}=209B; I_{pp}=1.9A$	K	A
SL	SMAJ150	VISH	VS	$V_{BR}(I_T=1.0mA)=167...204B; V_{WM}=268B; I_{pp}=1.5A$	K	A
SM	SMAJ150A	VISH	VS	$V_{BR}(I_T=1.0mA)=167...185B; V_{WM}=243B; I_{pp}=1.6A$	K	A
SN	SMAJ160	VISH	VS	$V_{BR}(I_T=1.0mA)=178...218B; V_{WM}=287B; I_{pp}=1.4A$	K	A
SP	SMAJ160A	VISH	VS	$V_{BR}(I_T=1.0mA)=178...197B; V_{WM}=259B; I_{pp}=1.5A$	K	A
SQ	SMAJ170	VISH	VS	$V_{BR}(I_T=1.0mA)=189...231B; V_{WM}=304B; I_{pp}=1.3A$	K	A
SR	SMAJ170	VISH	VS	$V_{BR}(I_T=1.0mA)=189...209B; V_{WM}=275B; I_{pp}=1.4A$	K	A
TD	SMAJ5.0C	VISH	VS	$V_{BR}(I_T=10.0mA)=6.40...7.30B; V_{WM}=9.6B; I_{pp}=41.6A$	x	x
TE	SMAJ5.0AC	VISH	VS	$V_{BR}(I_T=10.0mA)=6.4...7.0B; V_{WM}=9.2B; I_{pp}=43.5A$	x	x
TF	SMAJ6.0C	VISH	VS	$V_{BR}(I_T=10.0mA)=6.67...8.15B; V_{WM}=11.4B; I_{pp}=35.1A$	x	x
TG	SMAJ6.0AC	VISH	VS	$V_{BR}(I_T=10.0mA)=6.67...7.37B; V_{WM}=10.3B; I_{pp}=38.8A$	x	x
TH	SMAJ6.5C	VISH	VS	$V_{BR}(I_T=10.0mA)=7.22...8.82B; V_{WM}=12.3B; I_{pp}=32.5A$	x	x
TK	SMAJ6.5AC	VISH	VS	$V_{BR}(I_T=10.0mA)=7.22...7.98B; V_{WM}=11.2B; I_{pp}=35.7A$	x	x
TL	SMAJ7.0C	VISH	VS	$V_{BR}(I_T=10.0mA)=7.78...9.51B; V_{WM}=13.3B; I_{pp}=30.1A$	x	x
TM	SMAJ7.0AC	VISH	VS	$V_{BR}(I_T=10.0mA)=7.78...8.60B; V_{WM}=12.0B; I_{pp}=33.3A$	x	x
TN	SMAJ7.5C	VISH	VS	$V_{BR}(I_T=1.0mA)=8.33...10.3B; V_{WM}=14.3B; I_{pp}=28.0A$	x	x
TP	SMAJ7.5AC	VISH	VS	$V_{BR}(I_T=1.0mA)=8.33...9.21B; V_{WM}=12.9B; I_{pp}=31.0A$	x	x
TQ	SMAJ8.0C	VISH	VS	$V_{BR}(I_T=1.0mA)=8.89...10.9B; V_{WM}=15.0B; I_{pp}=26.5A$	x	x
TR	SMAJ8.0AC	VISH	VS	$V_{BR}(I_T=1.0mA)=8.89...9.83B; V_{WM}=13.6B; I_{pp}=29.4A$	x	x
TS	SMAJ8.5C	VISH	VS	$V_{BR}(I_T=1.0mA)=9.44...11.5B; V_{WM}=15.9B; I_{pp}=25.1A$	x	x
TT	SMAJ8.5AC	VISH	VS	$V_{BR}(I_T=1.0mA)=9.44...10.4B; V_{WM}=14.4B; I_{pp}=27.7A$	x	x
TU	SMAJ9.0C	VISH	VS	$V_{BR}(I_T=1.0mA)=10.0...12.2B; V_{WM}=16.9B; I_{pp}=23.6A$	x	x
TV	SMAJ9.0AC	VISH	VS	$V_{BR}(I_T=1.0mA)=10.0...11.1B; V_{WM}=15.4B; I_{pp}=26.0A$	x	x
TW	SMAJ10C	VISH	VS	$V_{BR}(I_T=1.0mA)=11.1...13.6B; V_{WM}=18.8B; I_{pp}=21.2A$	x	x
TX	SMAJ10AC	VISH	VS	$V_{BR}(I_T=1.0mA)=11.1...12.3B; V_{WM}=17.0B; I_{pp}=23.5A$	x	x
TY	SMAJ11C	VISH	VS	$V_{BR}(I_T=1.0mA)=12.2...14.9B; V_{WM}=20.1B; I_{pp}=20.0A$	x	x
TZ	SMAJ11AC	VISH	VS	$V_{BR}(I_T=1.0mA)=12.2...13.5B; V_{WM}=18.2B; I_{pp}=22.0A$	x	x
UA	US1A	GS	FD	$V_R=50B; I_F=1A; C_D=17пФ$	K	A
UB	US1B	GS	FD	$V_R=100B; I_F=1A; C_D=17пФ$	K	A
UD	SMAJ12C	VISH	VS	$V_{BR}(I_T=1.0mA)=13.3...16.3B; V_{WM}=22.0B; I_{pp}=18.1A$	x	x
UD	US1D	GS	FD	$V_R=200B; I_F=1A; C_D=17пФ$	K	A
UE	SMAJ12AC	VISH	VS	$V_{BR}(I_T=1.0mA)=13.3...14.7B; V_{WM}=19.9B; I_{pp}=20.1A$	x	x
UF	SMAJ13C	VISH	VS	$V_{BR}(I_T=1.0mA)=14.4...17.6B; V_{WM}=23.8B; I_{pp}=16.8A$	x	x
UG	SMAJ13AC	VISH	VS	$V_{BR}(I_T=1.0mA)=14.4...15.9B; V_{WM}=21.5B; I_{pp}=18.6A$	x	x
UG	US1G	GS	FD	$V_R=400B; I_F=1A; C_D=17пФ$	K	A
UH	SMAJ14C	VISH	VS	$V_{BR}(I_T=1.0mA)=15.6...19.1B; V_{WM}=25.8B; I_{pp}=15.5A$	x	x
UJ	US1J	GS	FD	$V_R=600B; I_F=1A; C_D=15пФ$	K	A
UK	SMAJ14AC	VISH	VS	$V_{BR}(I_T=1.0mA)=15.6...17.2B; V_{WM}=23.2B; I_{pp}=17.2A$	x	x
UL	SMAJ15C	VISH	VS	$V_{BR}(I_T=1.0mA)=16.7...20.4B; V_{WM}=26.9B; I_{pp}=14.8A$	x	x
UM	SMAJ15AC	VISH	VS	$V_{BR}(I_T=1.0mA)=16.7...18.5B; V_{WM}=24.4B; I_{pp}=16.4A$	x	x
UN	SMAJ16C	VISH	VS	$V_{BR}(I_T=1.0mA)=17.8...21.8B; V_{WM}=28.8B; I_{pp}=13.8A$	x	x
UP	SMAJ16AC	VISH	VS	$V_{BR}(I_T=1.0mA)=16.7...19.7B; V_{WM}=26.0B; I_{pp}=15.3A$	x	x
UQ	SMAJ17C	VISH	VS	$V_{BR}(I_T=1.0mA)=18.9...23.1B; V_{WM}=30.5B; I_{pp}=13.1A$	x	x
UR	SMAJ17AC	VISH	VS	$V_{BR}(I_T=1.0mA)=18.9...20.9B; V_{WM}=27.6B; I_{pp}=14.5A$	x	x
US	SMAJ18C	VISH	VS	$V_{BR}(I_T=1.0mA)=20.0...24.4B; V_{WM}=32.2B; I_{pp}=12.4A$	x	x
UT	SMAJ18AC	VISH	VS	$V_{BR}(I_T=1.0mA)=20.0...22.1B; V_{WM}=29.2B; I_{pp}=13.7A$	x	x
UU	SMAJ20C	VISH	VS	$V_{BR}(I_T=1.0mA)=22.2...27.1B; V_{WM}=35.8B; I_{pp}=11.1A$	x	x
UV	SMAJ20AC	VISH	VS	$V_{BR}(I_T=1.0mA)=22.2...24.5B; V_{WM}=32.4B; I_{pp}=12.3A$	x	x
UW	SMAJ22C	VISH	VS	$V_{BR}(I_T=1.0mA)=24.4...29.8B; V_{WM}=39.4B; I_{pp}=10.1A$	x	x
UX	SMAJ22AC	VISH	VS	$V_{BR}(I_T=1.0mA)=24.4...26.9B; V_{WM}=35.5B; I_{pp}=11.2A$	x	x

DO-214AC (продолжение)

Код	Типономинал	Фирма	Функция	Особенности	Цоколевка	
					1	2
UY	SMAJ24C	VISH	VS	$V_{BR}(I_T=1.0mA)=26.7...32.6B; V_{WM}=43.0B; I_{pp}=9.3A$	x	x
UZ	SMAJ24AC	VISH	VS	$V_{BR}(I_T=1.0mA)=26.7...29.5B; V_{WM}=38.9B; I_{pp}=10.3A$	x	x
VD	SMAJ26C	VISH	VS	$V_{BR}(I_T=1.0mA)=28.9...31.9B; V_{WM}=46.6B; I_{pp}=8.6A$	x	x
VE	SMAJ26AC	VISH	VS	$V_{BR}(I_T=1.0mA)=28.9...25.3B; V_{WM}=42.1B; I_{pp}=9.5A$	x	x
VF	SMAJ28C	VISH	VS	$V_{BR}(I_T=1.0mA)=31.1...38.0B; V_{WM}=50.0B; I_{pp}=8.0A$	x	x
VG	SMAJ28AC	VISH	VS	$V_{BR}(I_T=1.0mA)=31.1...34.4B; V_{WM}=45.4B; I_{pp}=8.8A$	x	x
VH	SMAJ30C	VISH	VS	$V_{BR}(I_T=1.0mA)=33.3...40.7B; V_{WM}=53.5B; I_{pp}=7.5A$	x	x
VK	SMAJ30AC	VISH	VS	$V_{BR}(I_T=1.0mA)=33.3...36.8B; V_{WM}=48.4B; I_{pp}=8.3A$	x	x
VL	SMAJ33C	VISH	VS	$V_{BR}(I_T=1.0mA)=36.7...44.9B; V_{WM}=59.0B; I_{pp}=6.8A$	x	x
VM	SMAJ33AC	VISH	VS	$V_{BR}(I_T=1.0mA)=36.7...40.6B; V_{WM}=53.3B; I_{pp}=7.5A$	x	x
VN	SMAJ36C	VISH	VS	$V_{BR}(I_T=1.0mA)=40.0...48.9B; V_{WM}=64.3B; I_{pp}=6.2A$	x	x
VP	SMAJ36AC	VISH	VS	$V_{BR}(I_T=1.0mA)=40.0...44.2B; V_{WM}=58.1B; I_{pp}=6.9A$	x	x
VQ	SMAJ40C	VISH	VS	$V_{BR}(I_T=1.0mA)=44.4...54.3B; V_{WM}=71.4B; I_{pp}=5.6A$	x	x
VR	SMAJ40AC	VISH	VS	$V_{BR}(I_T=1.0mA)=44.4...49.1B; V_{WM}=64.5B; I_{pp}=6.2A$	x	x
VS	SMAJ43C	VISH	VS	$V_{BR}(I_T=1.0mA)=47.8...58.4B; V_{WM}=76.7B; I_{pp}=5.2A$	x	x
VT	SMAJ43AC	VISH	VS	$V_{BR}(I_T=1.0mA)=47.8...52.8B; V_{WM}=69.4B; I_{pp}=5.7A$	x	x
VU	SMAJ45C	VISH	VS	$V_{BR}(I_T=1.0mA)=50.0...61.1B; V_{WM}=80.3B; I_{pp}=5.0A$	x	x
VV	SMAJ45AC	VISH	VS	$V_{BR}(I_T=1.0mA)=50.0...55.3B; V_{WM}=72.7B; I_{pp}=5.5A$	x	x
VW	SMAJ48C	VISH	VS	$V_{BR}(I_T=1.0mA)=53.3...65.1B; V_{WM}=85.5B; I_{pp}=4.7A$	x	x
VX	SMAJ48AC	VISH	VS	$V_{BR}(I_T=1.0mA)=53.3...58.9B; V_{WM}=77.4B; I_{pp}=5.2A$	x	x
VY	SMAJ51C	VISH	VS	$V_{BR}(I_T=1.0mA)=56.7...69.3B; V_{WM}=91.1B; I_{pp}=4.4A$	x	x
VZ	SMAJ51AC	VISH	VS	$V_{BR}(I_T=1.0mA)=56.7...62.7B; V_{WM}=82.4B; I_{pp}=4.9A$	x	x
WD	SMAJ54C	VISH	VS	$V_{BR}(I_T=1.0mA)=60.00...73.3B; V_{WM}=96.3B; I_{pp}=4.2A$	x	x
WE	SMAJ54AC	VISH	VS	$V_{BR}(I_T=1.0mA)=60.00...66.3B; V_{WM}=87.1B; I_{pp}=4.6A$	x	x
WF	SMAJ58C	VISH	VS	$V_{BR}(I_T=1.0mA)=64.4...78.7B; V_{WM}=103B; I_{pp}=3.9A$	x	x
WG	SMAJ58AC	VISH	VS	$V_{BR}(I_T=1.0mA)=64.4...71.2B; V_{WM}=93.6B; I_{pp}=4.3A$	x	x
WH	SMAJ60C	VISH	VS	$V_{BR}(I_T=1.0mA)=66.7...81.5B; V_{WM}=107B; I_{pp}=3.7A$	x	x
WK	SMAJ60AC	VISH	VS	$V_{BR}(I_T=1.0mA)=66...73.7B; V_{WM}=96.8B; I_{pp}=4.1A$	x	x
WL	SMAJ64C	VISH	VS	$V_{BR}(I_T=1.0mA)=71.1...86.4B; V_{WM}=114B; I_{pp}=3.5A$	x	x
WM	SMAJ64AC	VISH	VS	$V_{BR}(I_T=1.0mA)=71.1...78.6B; V_{WM}=103B; I_{pp}=3.9A$	x	x
WN	SMAJ70C	VISH	VS	$V_{BR}(I_T=1.0mA)=77.8...95.1B; V_{WM}=125B; I_{pp}=3.2A$	x	x
WP	SMAJ70AC	VISH	VS	$V_{BR}(I_T=1.0mA)=77.8...86.0B; V_{WM}=113B; I_{pp}=3.5A$	x	x
WQ	SMAJ75C	VISH	VS	$V_{BR}(I_T=1.0mA)=83.3...102B; V_{WM}=134B; I_{pp}=3.0A$	x	x
WR	SMAJ75AC	VISH	VS	$V_{BR}(I_T=1.0mA)=83.3...92.1B; V_{WM}=121B; I_{pp}=3.3A$	x	x
WS	SMAJ78C	VISH	VS	$V_{BR}(I_T=1.0mA)=86.7...106B; V_{WM}=139B; I_{pp}=2.9A$	x	x
WT	SMAJ78AC	VISH	VS	$V_{BR}(I_T=1.0mA)=86.7...95.8B; V_{WM}=126B; I_{pp}=2.2A$	x	x
WU	SMAJ85C	VISH	VS	$V_{BR}(I_T=1.0mA)=94.4...115B; V_{WM}=151B; I_{pp}=2.6A$	x	x
WV	SMAJ85AC	VISH	VS	$V_{BR}(I_T=1.0mA)=94.4...104B; V_{WM}=137B; I_{pp}=2.9A$	x	x
WW	SMAJ90C	VISH	VS	$V_{BR}(I_T=1.0mA)=100...122B; V_{WM}=160B; I_{pp}=2.5A$	x	x
WX	SMAJ90AC	VISH	VS	$V_{BR}(I_T=1.0mA)=100...111B; V_{WM}=146B; I_{pp}=2.7A$	x	x
WY	SMAJ100C	VISH	VS	$V_{BR}(I_T=1.0mA)=111...136B; V_{WM}=179B; I_{pp}=2.2A$	x	x
WZ	SMAJ100AC	VISH	VS	$V_{BR}(I_T=1.0mA)=111...123B; V_{WM}=162B; I_{pp}=2.5A$	x	x
XD	SMAJ110C	VISH	VS	$V_{BR}(I_T=1.0mA)=122...149B; V_{WM}=196B; I_{pp}=2.0A$	x	x
XE	SMAJ110AC	VISH	VS	$V_{BR}(I_T=1.0mA)=122...135B; V_{WM}=177B; I_{pp}=2.3A$	x	x
XF	SMAJ120C	VISH	VS	$V_{BR}(I_T=1.0mA)=133...163B; V_{WM}=214B; I_{pp}=1.9A$	x	x
XG	SMAJ120AC	VISH	VS	$V_{BR}(I_T=1.0mA)=133...147B; V_{WM}=193B; I_{pp}=2.0A$	x	x
XH	SMAJ130C	VISH	VS	$V_{BR}(I_T=1.0mA)=144...176B; V_{WM}=231B; I_{pp}=1.7A$	x	x
XK	SMAJ130AC	VISH	VS	$V_{BR}(I_T=1.0mA)=144...159B; V_{WM}=209B; I_{pp}=1.9A$	x	x
XL	SMAJ150C	VISH	VS	$V_{BR}(I_T=1.0mA)=167...204B; V_{WM}=268B; I_{pp}=1.5A$	x	x
XM	SMAJ150AC	VISH	VS	$V_{BR}(I_T=1.0mA)=167...185B; V_{WM}=243B; I_{pp}=1.6A$	x	x
XN	SMAJ160C	VISH	VS	$V_{BR}(I_T=1.0mA)=178...218B; V_{WM}=287B; I_{pp}=1.4A$	x	x
XP	SMAJ160AC	VISH	VS	$V_{BR}(I_T=1.0mA)=178...197B; V_{WM}=259B; I_{pp}=1.5A$	x	x
XQ	SMAJ170C	VISH	VS	$V_{BR}(I_T=1.0mA)=189...231B; V_{WM}=304B; I_{pp}=1.3A$	x	x

DO-214AC (продолжение)

Код	Типономинал	Фирма	Функция	Особенности	Цоколевка	
					1	2
XR	SMAJ170C	VISH	VS	$V_{BR}(I_T=1.0mA)=189...209B; V_{WM}=275B; I_{pp}=1.4A$	x	x
ZHK	SMAZ5V1	VISH	DZ	$V_z(I_z=100mA)=4.8...5.4B; Z_{Z1}=5.0OM$	K	A
ZHL	SMAZ5V6	VISH	DZ	$V_z(I_z=100mA)=5.2...6.0B; Z_{Z1}=2.0OM$	K	A
ZHN	SMAZ6V2	VISH	DZ	$V_z(I_z=100mA)=5.8...6.6B; Z_{Z1}=2.0OM$	K	A
ZHO	SMAZ6V8	VISH	DZ	$V_z(I_z=100mA)=6.4...7.21B; Z_{Z1}=2.0OM$	K	A
ZHQ	SMAZ7V5	VISH	DZ	$V_z(I_z=100mA)=7.0...7.9B; Z_{Z1}=2.0OM$	K	A
ZHR	SMAZ8V2	VISH	DZ	$V_z(I_z=100mA)=7.7...8.7B; Z_{Z1}=2.0OM$	K	A
ZHT	SMAZ9V1	VISH	DZ	$V_z(I_z=50mA)=8.5...9.6B; Z_{Z1}=4.0OM$	K	A
ZHU	SMAZ10	VISH	DZ	$V_z(I_z=50mA)=9.4...10.6B; Z_{Z1}=4.0OM$	K	A
ZHW	SMAZ12	VISH	DZ	$V_z(I_z=50mA)=11.4...12.7B; Z_{Z1}=7.0OM$	K	A
ZHZ	SMAZ15	VISH	DZ	$V_z(I_z=50mA)=13.8...15.6B; Z_{Z1}=10OM$	K	A
ZJA	SMAZ16	VISH	DZ	$V_z(I_z=25mA)=15.3...17.1B; Z_{Z1}=15OM$	K	A
ZJF	SMAZ18	VISH	DZ	$V_z(I_z=25mA)=16.8...19.1B; Z_{Z1}=15OM$	K	A
ZJG	SMAZ20	VISH	DZ	$V_z(I_z=25mA)=18.8...21.2B; Z_{Z1}=15OM$	K	A
ZJK	SMAZ22	VISH	DZ	$V_z(I_z=25mA)=20.8...23.3B; Z_{Z1}=15OM$	K	A
ZJL	SMAZ24	VISH	DZ	$V_z(I_z=25mA)=22.8...25.6B; Z_{Z1}=15OM$	K	A
ZJN	SMAZ27	VISH	DZ	$V_z(I_z=25mA)=25.1...28.9B; Z_{Z1}=15OM$	K	A
ZJQ	SMAZ30	VISH	DZ	$V_z(I_z=25mA)=28...32B; Z_{Z1}=15OM$	K	A
ZJR	SMAZ33	VISH	DZ	$V_z(I_z=25mA)=31...35B; Z_{Z1}=15OM$	K	A
ZJS	SMAZ36	VISH	DZ	$V_z(I_z=10mA)=34...38B; Z_{Z1}=40OM$	K	A
ZJT	SMAZ39	VISH	DZ	$V_z(I_z=10mA)=37...41B; Z_{Z1}=40OM$	K	A
ZJV	SMAZ47	VISH	DZ	$V_z(I_z=10mA)=44...50B; Z_{Z1}=45OM$	K	A
ZKM	SMAZ68	VISH	DZ	$V_z(I_z=10mA)=64...72B; Z_{Z1}=80OM$	K	A
ZKQ	SMAZ100	VISH	DZ	$V_z(I_z=5.0mA)=94...106B; Z_{Z1}=200OM$	K	A
ZKR	SMAZ150	VISH	DZ	$V_z(I_z=5.0mA)=138...156B; Z_{Z1}=300OM$	K	A
ZKW	SMAZ200	VISH	DZ	$V_z(I_z=5.0mA)=188...212B; Z_{Z1}=350OM$	K	A

DO-215AA

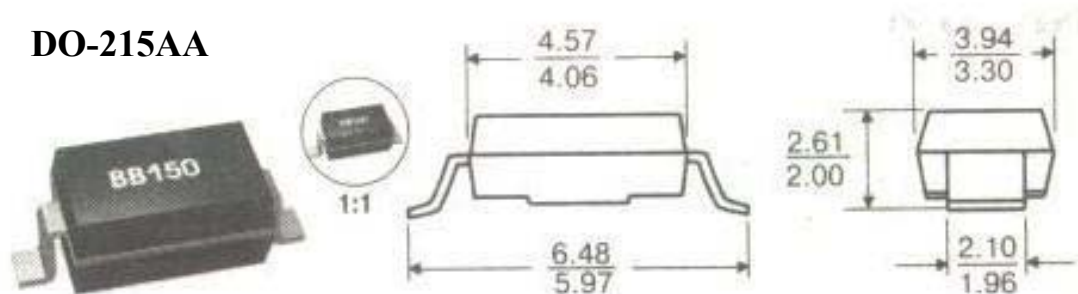

Код	Типономинал	Фирма	Функция	Особенности	Цоколевка	
					1	2
WA	SMZG3789A	GS	DZ	$V_z(I_z=37.5_{mA})=10B\pm 10\%$; $Z_{ZT}=5.00M$	K	A
WB	SMZG3789B	GS	DZ	$V_z(I_z=37.5_{mA})=10B\pm 5\%$; $Z_{ZT}=5.00M$	K	A
WC	SMZG3790A	GS	DZ	$V_z(I_z=34.1_{mA})=11B\pm 10\%$; $Z_{ZT}=6.00M$	K	A
WD	SMZG3790B	GS	DZ	$V_z(I_z=34.1_{mA})=11B\pm 5\%$; $Z_{ZT}=6.00M$	K	A
WE	SMZG3791A	GS	DZ	$V_z(I_z=31.2_{mA})=12B\pm 10\%$; $Z_{ZT}=7.00M$	K	A
WF	SMZG3791B	GS	DZ	$V_z(I_z=31.2_{mA})=12B\pm 5\%$; $Z_{ZT}=7.00M$	K	A
WG	SMZG3792A	GS	DZ	$V_z(I_z=28.8_{mA})=13B\pm 10\%$; $Z_{ZT}=7.50M$	K	A
WH	SMZG3792B	GS	DZ	$V_z(I_z=28.8_{mA})=13B\pm 5\%$; $Z_{ZT}=7.50M$	K	A
WI	SMZG3793A	GS	DZ	$V_z(I_z=25.0_{mA})=15B\pm 10\%$; $Z_{ZT}=9.00M$	K	A
WJ	SMZG3793B	GS	DZ	$V_z(I_z=25.0_{mA})=15B\pm 5\%$; $Z_{ZT}=9.00M$	K	A
WK	SMZG3794A	GS	DZ	$V_z(I_z=23.4_{mA})=16B\pm 10\%$; $Z_{ZT}=10.00M$	K	A
WL	SMZG3794B	GS	DZ	$V_z(I_z=23.4_{mA})=16B\pm 5\%$; $Z_{ZT}=10.00M$	K	A
XA	SMZG3795A	GS	DZ	$V_z(I_z=20.8_{mA})=18B\pm 10\%$; $Z_{ZT}=12.00M$	K	A
XB	SMZG3795B	GS	DZ	$V_z(I_z=20.8_{mA})=18B\pm 5\%$; $Z_{ZT}=12.00M$	K	A
XC	SMZG3796A	GS	DZ	$V_z(I_z=18.7_{mA})=20B\pm 10\%$; $Z_{ZT}=14.00M$	K	A
XD	SMZG3796B	GS	DZ	$V_z(I_z=18.7_{mA})=20B\pm 5\%$; $Z_{ZT}=14.00M$	K	A
XE	SMZG3797A	GS	DZ	$V_z(I_z=17.0_{mA})=22B\pm 10\%$; $Z_{ZT}=17.50M$	K	A
XF	SMZG3797B	GS	DZ	$V_z(I_z=17.0_{mA})=22B\pm 5\%$; $Z_{ZT}=17.50M$	K	A
XG	SMZG3798A	GS	DZ	$V_z(I_z=15.6_{mA})=24B\pm 10\%$; $Z_{ZT}=19.00M$	K	A
XH	SMZG3798B	GS	DZ	$V_z(I_z=15.6_{mA})=24B\pm 5\%$; $Z_{ZT}=19.00M$	K	A
XI	SMZG3799A	GS	DZ	$V_z(I_z=13.9_{mA})=27B\pm 10\%$; $Z_{ZT}=23.00M$	K	A
XJ	SMZG3799B	GS	DZ	$V_z(I_z=13.9_{mA})=27B\pm 5\%$; $Z_{ZT}=23.00M$	K	A
XK	SMZG3800A	GS	DZ	$V_z(I_z=12.5_{mA})=30B\pm 10\%$; $Z_{ZT}=26.00M$	K	A
XL	SMZG3800B	GS	DZ	$V_z(I_z=12.5_{mA})=30B\pm 5\%$; $Z_{ZT}=26.00M$	K	A
YA	SMZG3801A	GS	DZ	$V_z(I_z=11.4_{mA})=33B\pm 10\%$; $Z_{ZT}=33.00M$	K	A
YB	SMZG3801B	GS	DZ	$V_z(I_z=11.4_{mA})=33B\pm 5\%$; $Z_{ZT}=33.00M$	K	A
YC	SMZG3802A	GS	DZ	$V_z(I_z=10.4_{mA})=36B\pm 10\%$; $Z_{ZT}=38.00M$	K	A
YD	SMZG3802B	GS	DZ	$V_z(I_z=10.4_{mA})=36B\pm 5\%$; $Z_{ZT}=38.00M$	K	A
YE	SMZG3803A	GS	DZ	$V_z(I_z=9.6_{mA})=39B\pm 10\%$; $Z_{ZT}=45.00M$	K	A
YF	SMZG3803B	GS	DZ	$V_z(I_z=9.6_{mA})=39B\pm 5\%$; $Z_{ZT}=45.00M$	K	A
YG	SMZG3804A	GS	DZ	$V_z(I_z=8.7_{mA})=43B\pm 10\%$; $Z_{ZT}=53.00M$	K	A
YN	SMZG3804B	GS	DZ	$V_z(I_z=8.7_{mA})=43B\pm 5\%$; $Z_{ZT}=53.00M$	K	A
YI	SMZG3805A	GS	DZ	$V_z(I_z=8.0_{mA})=47B\pm 10\%$; $Z_{ZT}=67.00M$	K	A
YJ	SMZG3805B	GS	DZ	$V_z(I_z=8.0_{mA})=47B\pm 5\%$; $Z_{ZT}=67.00M$	K	A
YK	SMZG3806A	GS	DZ	$V_z(I_z=7.3_{mA})=51B\pm 10\%$; $Z_{ZT}=70.00M$	K	A
YL	SMZG3806B	GS	DZ	$V_z(I_z=7.3_{mA})=51B\pm 5\%$; $Z_{ZT}=70.00M$	K	A
ZA	SMZG3807A	GS	DZ	$V_z(I_z=6.7_{mA})=56B\pm 10\%$; $Z_{ZT}=86.00M$	K	A
ZB	SMZG3807B	GS	DZ	$V_z(I_z=6.7_{mA})=56B\pm 5\%$; $Z_{ZT}=86.00M$	K	A
ZC	SMZG3808A	GS	DZ	$V_z(I_z=6.0_{mA})=62B\pm 10\%$; $Z_{ZT}=100.00M$	K	A
ZD	SMZG3808B	GS	DZ	$V_z(I_z=6.0_{mA})=62B\pm 5\%$; $Z_{ZT}=100.00M$	K	A
ZE	SMZG3809A	GS	DZ	$V_z(I_z=5.5_{mA})=68B\pm 10\%$; $Z_{ZT}=120.00M$	K	A
ZF	SMZG3809B	GS	DZ	$V_z(I_z=5.5_{mA})=68B\pm 5\%$; $Z_{ZT}=120.00M$	K	A

SOD-123



Цвет полосы	Тип	Типономинал	Фирма	Функция	Особенности	Цоколевка	
						1	2
Белая	2	BB419	SIEM	BD	$V_R < 28B; I_F < 20_{MA}; I_R < 0.02_{MKA}; C_{3V} = 26 \dots 32 \text{ пФ}; C_{3V}/C_{25V} = 5 \dots 6.5$	К	А
Белая	A	BAT14-098	SIEM	SHD	$V_R < 4B; I_F < 90_{MA}; V_F(I_F = 10_{MA}) < 0.55B; C_D < 0.35 \text{ пФ};$	К	А
Белая	B	BAT15-098	SIEM	SHD	$V_R < 4B; I_F < 110_{MA}; V_F(I_F = 10_{MA}) < 0.32B; C_D < 0.35 \text{ пФ};$	К	А
Белая	C	BAT65	SIEM	SHD	$V_R < 30B; I_F < 500_{MA}; V_F(I_F = 250_{MA}) < 0.7B; I_R < 10_{MKA}; C_D < 12 \text{ пФ};$	К	А
Белая	M	BB512	SIEM	BD	$V_R < 12B; I_F < 50_{MA}; I_R < 0.02_{MKA}; C_{1V} = 440 \dots 520 \text{ пФ}; C_{1V}/C_{8V} > 15$	К	А
Белая	P	BA586	SIEM	PIN	$V_R < 50B; I_F < 50_{MA}; V_F(I_F = 50_{MA}) < 1.15B; I_R < 0.05_{MKA}; C_D < 0.2 \text{ пФ};$	К	А
Белая	R	BA585	SIEM	PIN	$V_R < 50B; I_F < 50_{MA}; V_F(I_F = 50_{MA}) < 1.1B; I_R < 0.05_{MKA}; C_D < 0.4 \text{ пФ};$	К	А
Белая	S	BB515	SIEM	BD	$V_R < 30B; I_F < 20_{MA}; I_R < 0.01_{MKA}; C_{1V} = 17.5 \dots 20 \text{ пФ}; C_{1V}/C_{28V} = 8.2 \dots 9.8$	К	А
Белая	T	BB811	SIEM	BD	$V_R < 30B; I_F < 20_{MA}; I_R < 0.02_{MKA}; C_{1V} = 7.8 \dots 9.8 \text{ пФ}; C_{1V}/C_{28V} = 7.8 \dots 9.5$	К	А
голубая	S	BA582	SIEM	DTV	$V_R < 35B; I_F < 100_{MA}; V_F(I_F = 100_{MA}) < 1.0B; I_R < 0.02_{MKA}; C_D < 1.1 \text{ пФ};$	К	А
Желтая	S	BB619	SIEM	BD	$V_R < 30B; I_F < 20_{MA}; I_R < 0.01_{MKA}; C_{1V} = 36 \dots 42 \text{ пФ}; C_{1V}/C_{28V} > 13.5$	К	А
Желтая	S	BB619C	SIEM	BD	$V_R < 30B; I_F < 20_{MA}; I_R < 0.01_{MKA}; C_{1V} = 36 \dots 42 \text{ пФ}; C_{1V}/C_{28V} > 13.5$	К	А
красная	S	BB620	SIEM	BD	$V_R < 30B; I_F < 20_{MA}; I_R < 0.01_{MKA}; C_{1V} = 62 \dots 76 \text{ пФ}; C_{1V}/C_{28V} = 19.5 \dots 25$	К	А

SOD-91

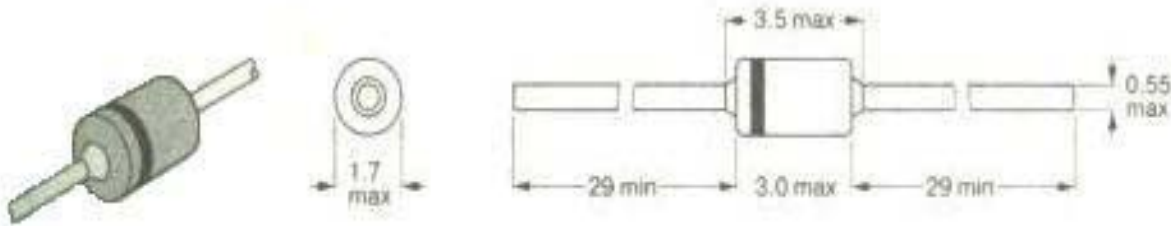

Тип	Типономинал	Фирма	Функция	Особенности	Цокол	
					1	2
11D	BYD11D	PHIL	BYG	$V_R < 200B; I_F < 0.5A; V_F(0.5A) < 0.91B; V_R > 225B; I_R < 1_{MKA}; C_D = 14 \text{ пФ}; t_{RR} = 3_{MCK}$	К	А
11G	BYD11G	PHIL	BYG	$V_R < 400B; I_F < 0.5A; V_F(0.5A) < 0.91B; V_R > 450B; I_R < 1_{MKA}; C_D = 14 \text{ пФ}; t_{RR} = 3_{MCK}$	К	А
11J	BYD11J	PHIL	BYG	$V_R < 600B; I_F < 0.5A; V_F(0.5A) < 0.91B; V_R > 650B; I_R < 1_{MKA}; C_D = 14 \text{ пФ}; t_{RR} = 3_{MCK}$	К	А
11K	BYD11K	PHIL	BYG	$V_R < 800B; I_F < 0.5A; V_F(0.5A) < 0.91B; V_R > 900B; I_R < 1_{MKA}; C_D = 14 \text{ пФ}; t_{RR} = 3_{MCK}$	К	А
11M	BYD11M	PHIL	BYG	$V_R < 1000B; I_F < 0.5A; V_F(0.5A) < 0.91B; V_R > 450B; I_R < 1_{MKA}; C_D = 14 \text{ пФ}; t_{RR} = 3_{MCK}$	К	А
31D	BYD31D	PHIL	BYD	$V_R < 200B; I_F < 0.44A; V_F(0.5A) < 1.35B; V_R > 300B; C_D = 9 \text{ пФ}; t_{RR} = 250 \text{ нс}$	К	А
31G	BYD31G	PHIL	BYD	$V_R < 400B; I_F < 0.44A; V_F(0.5A) < 1.35B; V_R > 500B; C_D = 9 \text{ пФ}; t_{RR} = 250 \text{ нс}$	К	А
31J	BYD31G	PHIL	BYD	$V_R < 600B; I_F < 0.44A; V_F(0.5A) < 1.35B; V_R > 700B; C_D = 9 \text{ пФ}; t_{RR} = 250 \text{ нс}$	К	А
31K	BYD31K	PHIL	BYD	$V_R < 800B; I_F < 0.44A; V_F(0.5A) < 1.35B; V_R > 900B; C_D = 8 \text{ пФ}; t_{RR} = 300 \text{ нс}$	К	А
31M	BYD31M	PHIL	FID	$V_R < 1000B; I_F < 0.44A; V_F(0.5A) < 1.35B; V_R > 1100B; C_D = 8 \text{ пФ}; t_{RR} = 300 \text{ нс}$	К	А
S11	BAS11	PHIL	DL	$V_R < 300B; I_F < 300_{MA}; V_F(I_F = 300_{MA}) < 1.0B; C_D = 20 \text{ пФ}; t_{RR} < 1_{MCK}$	К	А
S12	BAS12	PHIL	DL	$V_R < 400B; I_F < 300_{MA}; V_F(I_F = 300_{MA}) < 1.0B; C_D = 20 \text{ пФ}; t_{RR} < 1_{MCK}$	К	А

SOT143, TO-253

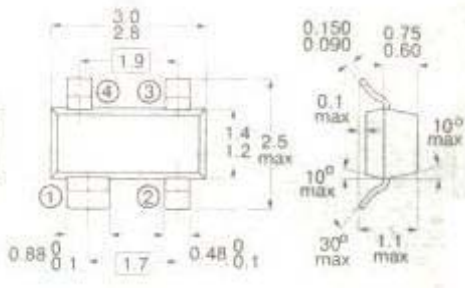
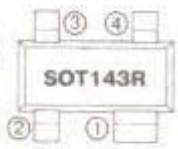
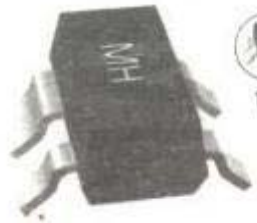

Код	Типономинал	Фирма	Функция	Особенности	Цоколевка			
					1	2	3	4
01	MRF9011LT1	MOT	NPN	$V_{CB0}=25B; I_C=30_{MA}; P_D=300_{MBT}; h_{21}=30..200;$ $f_T=3800_{MГц}$	C	E	B	E
02	MRF5711LT1	MOT	NPN	$V_{CB0}=20B; I_C=80_{MA}; P_D=580_{MBT}; h_{21}=50..300;$ $f_T=8000_{MГц}$	C	E	B	E
04	MRF4427	MOT	NPN	$V_{CB0}=40B; I_C=400_{MA}; P_D=220_{MBT}; h_{21}=10..200;$ $f_T=1600_{MГц}$	C	E	B	E
04	MRF5211LT1	MOT	NPN	$V_{CB0}=20B; I_C=70_{MA}; P_D=333_{MBT}; h_{21}=25..125;$ $f_T=4200_{MГц}$	C	E	B	E
05	MRF9331LT1	MOT	NPN	$V_{CB0}=15B; I_C=2_{MA}; P_D=50_{MBT}; h_{21}=30..200;$ $f_T=5000_{MГц}$	C	E	B	E
11	MRF9511ALT1	MOT	NPN	$V_{CB0}=20B; I_C=100_{MA}; P_D=322_{MBT}; h_{21}=75..150;$ $f_T=8000_{MГц}$	C	E	B	E
17	BAS125-07	SIEM	2xSHD	$V_R<25B; I_F<100_{MA}; V_F(I_F=35_{MA})<0.9B; I_R<1.0_{MKA};$ $C_D<1.1_{пФ}$	K1	K2	A2	A1
18	MRF9331LT1	MOT	NPN	$V_{CB0}=15B; I_C=2_{MA}; P_D=50_{MBT}; h_{21}=30..200;$ $f_T=3500_{MГц}$	C	E	B	E
18	MRF9411BLT1	MOT	NPN	$V_{CB0}=20B; I_C=50_{MA}; P_D=322_{MBT}; h_{21}=100..200;$ $f_T=8000_{MГц}$	C	E	B	E
18	MRF9411BLT3	MOT	NPN	$V_{CB0}=20B; I_C=50_{MA}; P_D=322_{MBT}; h_{21}=100..200;$ $f_T=8000_{MГц}$	C	E	B	E
1Jp	BCV61A	PHIL	NPN	$V_{CB0}=30B; I_C=100_{MA}; P_D=250_{MBT}; h_{21}=110..220;$ $f_T>100_{MГц}$	B1 B2 C2	C1	E1	E2
1Js	BCV61A	SIEM	NPN	$V_{CB0}=30B; I_C=100_{MA}; P_D=300_{MBT}; h_{21}=110..220;$ $f_T=250_{MГц}$	C1 B1 B2	C2	E2	E1
1Kp	BCV61B	PHIL	NPN	$V_{CB0}=30B; I_C=100_{MA}; P_D=250_{MBT}; h_{21}=200..450;$ $f_T>100_{MГц}$	B1 B2 C2	C1	E1	E2
1Ks	BCV61B	SIEM	NPN	$V_{CB0}=30B; I_C=100_{MA}; P_D=300_{MBT}; h_{21}=200..450; f_T=250$ $MГц$	C1 B1 B2	C2	E2	E1
1Lp	BCV61C	PHIL	NPN	$V_{CB0}=30B; I_C=100_{MA}; P_D=250_{MBT}; h_{21}=420..800;$ $f_T>100_{MГц}$	B1 B2 C2	C1	E1	E2
1Ls	BCV61C	SIEM	NPN	$V_{CB0}=30B; I_C=100_{MA}; P_D=300_{MBT}; h_{21}=420..800;$ $f_T>250_{MГц}$	C1 B1 B2	C2	E2	E1
1Mp	BCV61	PHIL	NPN	$V_{CB0}=30B; I_C=100_{MA}; P_D=250_{MBT}; h_{21}=110..800; f_T>100$ $MГц$	B1 B2 C2	C1	E1	E2
305	AT-30511	HP	NPN	$V_{CB0}=11B; I_C=8_{MA}; P_D=100_{MBT}; h_{21}=70..300; f_T=10_{ГГц}$	B	E	C	E
310	AT-31011	HP	NPN	$V_{CB0}=11B; I_C=16_{MA}; P_D=150_{MBT}; h_{21}=70..300;$ $f_T=10_{ГГц}$	B	E	C	E
320	AT-32011	HP	PNP	$V_{CB0}=11B; I_C=32_{MA}; P_D=200_{MBT}; h_{21}=70..300;$ $f_T=10_{ГГц}$	B	E	C	E
3Jp	BCV62A	PHIL	PNP	$V_{CB0}=30; I_C=100_{MA}; P_D=250_{MBT}; h_{21}=125..250;$ $f_T>100_{MГц}$	B1 B2 C2	C1	E1	E2
3Js	BCV62A	SIEM	PNP	$V_{CB0}=30B; I_C=100_{MA}; P_D=300_{MBT}; h_{21}=125..220;$ $f_T=250_{MГц}$	C1 B1 B2	C2	E2	E1
3Kp	BCV62B	PHIL	PNP	$V_{CB0}=30; I_C=100_{MA}; P_D=250_{MBT}; h_{21}=220..475;$ $f_T>100_{MГц}$	B1 B2 C2	C1	E1	E2

SOT143, TO-253 (продолжение)

Код	Типоминал	Фирма	Функция	Особенности	Цоколевка			
					1	2	3	4
3Ks	BCV62B	SIEM	PNP	$V_{CB0}=30B; I_C=100_{MA}; P_D=300_{MBT}; h_{21}=220..475;$ $f_T=250_{MГц}$	C1 B1 B2	C2	E2	E1
3Lp	BCV62C	PHIL	PNP	$V_{CB0}=30; I_C=100_{MA}; P_D=250_{MBT}; h_{21}=220..475;$ $f_T>100_{MГц}$	B1 B2 C2	C1	E1	E2
3Ls	BCV62C	SIEM	PNP	$V_{CB0}=30B; I_C=100_{MA}; P_D=300_{MBT}; h_{21}=420..800;$ $f_T=c250_{MГц}$	C1 B1 B2	C2	E2	E1
3Mp	BCV62	PHIL	PNP	$V_{CB0}=30; I_C=100_{MA}; P_D=250_{MBT}; h_{21}=100..800;$ $f_T>100_{MГц}$	B1 B2 C2	C1	E1	E2
414	AT-41411	HP	NPN	$V_{CB0}=30B; I_C=50_{MA}; P_D=225_{MBT}; h_{21}=30..270;$ $f_T=700_{MГц}$	C	E	B	E
47s	BAS40-07	SIEM	2xSHD	$V_R<40B; I_F<120_{MA}; V_F(I_F=40_{MA})<1,0B; I_R<1,0_{MKА};$ $C_D<5,0_{пФ};$	K1	K2	A2	A1
57	BAT17-07	SIEM	2xSHD	$V_R<4B; I_F<130_{MA}; V_F(I_F=10_{MA})<0,6B; I_R<0,25_{MKА}$ $C_D<0,75_{пФ};$	K1	K2	A2	A1
60	BAR60	SIEM	3xPIN	$V_R<100B; I_F<140_{MA}; V_F(I_F=100_{MA})<1,25B; I_R<0,1_{MKА}$ $C_D<0,2_{пФ};$	K1 K2 A3	K3	A1	A2
61	BAR61	SIEM	3xPIN	$V_R<100B; I_F<140_{MA}; V_F(I_F=100_{MA})<1,25B; I_R<0,1_{MKА}$ $C_D<0,2_{пФ};$	K2 A3	A1	K1 A2	A3
62	BAT62	SIEM	2xSHD	$V_R<40B; I_F<20_{MA}; V_F(I_F=2_{MA})<1,0B; I_R<10_{MKА};$ $C_D<0,6_{пФ};$	A1	K2	A2	K1
63	BAT63	SIEM	2xSHD	$V_R<3B; I_F<100_{MA}; V_F(I_F=1_{MA})<0,3B; I_R<0,01_{MKА};$ $C_D<0,85_{пФ};$	A1	K2	A2	K1
67s	BAT64-07	SIEM	2xSHD	$V_R<40B; I_F<250_{MA}; V_F(I_F=100_{MA})<0,75B; I_R<2,0_{MKА};$ $C_D<6_{пФ};$	K1	K2	A2	A1
77p	BAS70-07	PHIL	2xSHD	$V_R<70B; I_F<70_{MA}; V_F(I_F=1_{MA})<410_{MB}; C_D<2_{пФ};$	K1	K2	A2	A1
77s	BAS70-07	SIEM	2xSHD	$V_R<70B; I_F<70_{MA}; V_F(I_F=15_{MA})<1,0B; I_R<0,1_{MKА};$ $C_D<2,0_{пФ};$	K1	K2	A2	A1
8372	MRF8372	MOT	NPN	$V_{CB0}=36B; I_C=200_{MA}; P_D=1880_{MBT}; h_{21}=30..200$	C	E	B	E
97p	BCV65	PHIL	PNP(1)+ NPN(2)	$V_{CB0}=30B; I_C=100_{MA}; P_D=250_{MBT}; h_{21}=75..800$	C2	B1 B2	C1	E1 E2
98p	BCV65B	PHIL	PNP(1)+ NPN(2)	$V_{CB0}=30B; I_C=100_{MA}; P_D=250_{MBT}; h_{21}=200..475$	C2	B1 B2	C1	E1 E2
A	MRF94713	MOT	NPN	$V_{CB0}=20B; I_C=50_{MA}; P_D=188_{MBT}; h_{21}>50; f_T=8000_{MГц}$	C	E	B	E
A2	CFY30	SIEM	FET	$G_{AS}; V_{DS}=5B; I_D=80_{MA}; P_D=250_{MBT}; I_{DSS}=15..60_{MA};$ $g_F=30_{MOм}$	S	D	S	G
A5	HSMS-2805	HP	2xSHD	$V_{BR}>70B; V_F(I_F=15_{MA})<1,0B; I_R(V_R=50B)<200_{HA};$ $C_D<2,0_{пФ}; R_D=35_{OM}$	K1	K2	A2	A1
A61	BAS28	CENTS	2xFID	$I_F<250_{MA}; V_{BR}>75B; V_F(I_F=10_{MA})<0,855B; I_R<1000_{HA};$ $t_{RR}<6,0_{HC}; C_D<2,0_{пФ}$	A1	A2	K2	K1
A7	HSMS-2807	HP	4xSHD	$V_{BR}>70B; V_F(I_F=15_{MA})<1,0B; I_R(V_R=50B)<200_{HA};$ $C_D<2,0_{пФ}; R_D=35_{OM}$	K1 A4	K4 A3	K3 A2	K2 A1
A8	HSMS-2808	HP	4xSHD	$V_{BR}>70B; V_F(I_F=15_{MA})<1,0B; I_R(V_R=50B)<200_{HA};$ $C_D<2,0_{пФ}; R_D=35_{OM}$	K1 K4	A4 K3	A3 A2	K2 A1
B5	HSMS-2815	HP	2xSHD	$V_{BR}>20B; V_F(I_F=35_{MA})<1,0B; I_R(V_R=15B)<200_{HA};$ $C_T<1,2_{пФ}; R_D=15_{OM}$	K1	K2	A2	A1
B7	HSMS-2817	HP	4xSHD	$V_{BR}>20B; V_F(I_F=35_{MA})<1,0B; I_R(V_R=15B)<200_{HA};$ $C_D<1,2_{пФ}; R_D=15_{OM}$	K1 A4	K4 A3	K3 A2	K2 A1
B8	HSMS-2818	HP	4xSHD	$V_{BR}>20B; V_F(I_F=35_{MA})<1,0B; I_R(V_R=15B)<200_{HA};$ $C_D<1,2_{пФ}; R_D=15_{OM}$	K1 K4	A4 K3	A3 A2	K2 A1
C5	HSMS-2825	HP	2xSHD	$V_{BR}>15B; V_F(I_F=30_{MA})<0,7B; I_R(V_R=1B)<100_{HA};$ $C_D<1,0_{пФ}; R_D=12_{OM}$	K1	K2	A2	A1
C7	HSMS-2827	HP	4xSHD	$V_{BR}>15B; V_F(I_F=30_{MA})<0,7B; I_R(V_R=1B)<100_{HA};$ $C_T<1,0_{пФ}; R_D=12_{OM}$	K1 K4	A4 K3	A3 A2	K2 A1
C8	HSMS-2828	HP	4xSHD	$V_{BR}>15B; V_F(I_F=30_{MA})<0,7B; I_R(V_R=1B)<100_{HA};$ $C_T<1,0_{пФ}; R_D=12_{OM}$	K1 K4	A4 K3	A3 A2	K2 A1
C9	HSMS-2829	HP	4xSHD	$V_{BR}>15B; V_F(I_F=30_{MA})<0,7B; I_R(V_R=1B)<100_{HA};$ $C_T<1,0_{пФ}; R_D=12_{OM}$	K1 A2	A3 K4	A4 K2	K3 A1
C95	BCV64	PHIL	PNP	$V_{CB0}=30B; I_C=100_{MA}; P_D=250_{MBT}; h_{21}=110..800;$ $f_T>1000_{MГц}$	B1 C2	C1	E1 E2	B2
C96	BCV64B	PHIL	PNP	$V_{CB0}=30B; I_C=100_{MA}; P_D=250_{MBT}; h_{21}=220..475;$ $f_T>1000_{MГц}$	B1 C2	C1	E1 E2	B2
D95	BCV63	PHIL	NPN	$V_{CB0}=30B; I_C=100_{MA}; P_D=250_{MBT}; h_{21}=110..800;$ $f_T>1000_{MГц}$	B1 C2	C1	E1 E2	B2
D96	BCV63B	PHIL	NPN	$V_{CB0}=30B; I_C=100_{MA}; P_D=250_{MBT}; h_{21}=200..450;$ $f_T>1000_{MГц}$	B1 C2	C1	E1 E2	B2
FAs	BFP81	SIEM	NPN	$V_{CB0}=25B; I_C=30_{MA}; P_D=280_{MBT}; h_{21}=50..200;$ $f_T>5800_{MГц}$	C	E	B	E

SOT143, TO-253(продолжение)

Код	Типоминал	Фирма	Функция	Особенности	Цоколевка			
					1	2	3	4
FEs	BFP93A	SIEM	NPN	$V_{CB0}=20B; I_C=50mA; P_D=300mBT; h_{21}=50...200;$ $F_T>6000MГц$	C	E	B	E
G5	HSMP-3895	HP	2xPIN	$I_F<1A; P_D=250mBT; V_{BR}>100B; R_S>2.5OM; C_T<0.30пФ$	A1	A2	K2	K1
HNs	BBY51-07	SIEM	2xBD	$V_R<7B; I_F<20mA; I_R<0.01mA; C_{IV}=4.8...6.0пФ;$ $C_{2V}/C_{4V}=1.55...2.15$	K1	K2	A2	A1
JPs	BAW101	SIEM	2xDI	$V_R<300B; I_F<250mA; V_F(I_F=100mA)<1.3B; I_R<0.15mA;$ $C_D<6.0пФ; t_{RR}<1000нс$	K1	K2	A2	A1
JSs	BAW100	SIEM	2xDI	$V_R<75B; I_F<200mA; V_F(I_F=150mA)<1.25B; I_R<1.0mA;$ $C_D<2.0пФ; t_{RR}<6нс$	A1	A2	K2	K1
JTp	BAS28	SIEM	2xFD	$V_R<75B; I_F<215mA; V_F(I_F=50mA)<1.0B;$ $C_D<1.5пФ; t_{RR}<4нс$	K1	K2	A2	A1
JTs	BAS28	PHIL	2xDI	$V_R<75B; I_F<200mA; V_F(I_F=50mA)<1.0B; I_R<0.1mA;$ $C_D<2.0пФ; t_{RR}<6нс$	K1	K2	A2	A1
L30	BAV23	PHIL	2xD	$V_R<200B; I_F<225mA; V_F(I_F=100mA)<1.0B;$ $C_D<5пФ; t_{RR}<50нс$	K1	K2	A2	A1
L41	BAT74	PHIL	2xSHD	$V_R<30B; I_F<200mA; V_F(I_F=1mA)<320B;$ $C_D<10пФ; t_{RR}<5нс$	K1	K2	A2	A1
L51	BAS56	CENTS	2xFID	$I_F<200mA; V_{BR}>60B; V_F(I_F=10mA)<0.75B; I_R<100HA;$ $t_{RR}<6.0нс; C_D<2.5пФ$	A1	A2	K2	K1
L51	BAS56	PHIL	2xFID	$V_R<60B; I_F<200mA; V_F(I_F=200mA)<1.0B;$ $C_D<2.5пФ; t_{RR}<6нс$	K1	K2	A2	A1
M	BAR65-07	SIEM	2xPIN	$V_R<30B; I_F<100mA; V_F(I_F=50mA)<1.0B;$ $C_D<0.9пФ$	K1	K2	A2	A1
MB	BF995	SIEM	nMOS	$V_{DS}=20B; I_D=30mA; P_D=200mBT; N_F=1.1Дб;$ $I_{DSS}=4...20mA; g_F>12mCm$	S	D	G2	G1
MB	BF995	TELEF	nMOS	$V_{DS}=20B; I_D=30mA; P_D=200mBT; I_{DS}=4...18mA;$ $g_F>12mCm$	S	D	G2	G1
MG	BF994S	SIEM	nMOS	$V_{DS}=20B; I_D=30mA; P_D=200mBT; N_F=1Дб;$ $I_{DSS}=2...20mA; g_F>15mCm$	S	D	G2	G1
MG	BF994S	TELEF	nMOS	$V_{DS}=20B; I_D=30mA; P_D=200mBT; I_{DS}=4...18mA;$ $g_F>15mCm$	S	D	G2	G1
MH	BF996S	SIEM	nMOS	$V_{DS}=20B; I_D=30mA; P_D=200mBT; N_F=1.8Дб;$ $I_{DSS}=2...20mA; g_F>15mCm$	S	D	G2	G1
MH	BF996S	TELEF	nMOS	$V_{DS}=20B; I_D=30mA; P_D=200mBT; I_{DS}=4...18mA;$ $g_F>15mCm$	S	D	G2	G1
MK	BF997	SIEM	nMOS	$V_{DS}=20B; I_D=30mA; P_D=200mBT; N_F=1.0Дб;$ $I_{DSS}=2...20mA; g_F>15mCm$	S	D	G2	G1
MO	BF998	SIEM	nMOS	$V_{DS}=12B; I_D=30mA; P_D=200mBT; N_F=1.0Дб;$ $I_{DSS}=2...20mA; g_F>24mCm$	S	D	G2	G1
MO	BF998	TELEF	nMOS	$V_{DS}=12B; I_D=30mA; P_D=200mBT; I_{DS}=4...18mA;$ $g_F>21mCm$	S	D	G2	G1
MS	CF739	SIEM	nFET	GaAs; $V_{DS}=10B; I_D=80mA; P_D=240mBT; I_{DS}=6...60mA;$ $g_F=25mCm$	S	D	G2	G1
MX	CF750	SIEM	FET	GaAs; $V_{DS}=8B; I_D=80mA; P_D=300mBT; I_{DSS}=50mA;$ $g_F=25mCm$	GN D	D	G	S
MYs	BF1012	SIEM	nMOS	$V_{DS}=16B; I_D=25mA; P_D=200mBT; N_F=1.4Дб;$ $g_F=26mCm$	S	D	G2	G1
MZs	BF1005	SIEM	nMOS	$V_{DS}=8B; I_D=25mA; P_D=200mBT; N_F=1.4Дб;$ $g_F=24mCm$	S	D	G2	G1
NYs	BF1012S	SIEM	nMOS	$V_{DS}=16B; I_D=25mA; P_D=200mBT; N_F=1.4Дб;$ $g_F=26mCm$	S	D	G2	G1
NZs	BF1005S	SIEM	nMOS	$V_{DS}=8B; I_D=25mA; P_D=200mBT; N_F=1.6Дб;$ $g_F=24mCm$	S	D	G2	G1
PTs	BAR64-07	SIEM	2xPIN	$V_R<200B; I_F<100mA; V_F(I_F=50mA)<1.1B;$ $C_D<0.35пФ$	K1	K2	A2	A1
RAAs	BF772	SIEM	NPN	$V_{CB0}=20B; I_C=80mA; P_D=580mBT; h_{21}=50...200;$ $F_T=8000MГц$	C	E	B	E
RCs	BFP193	SIEM	NPN	$V_{CB0}=20B; I_C=80mA; P_D=580mBT; h_{21}=50...200;$ $f_T=8000MГц$	C	E	B	E
RDs	BFP180	SIEM	NPN	$V_{CB0}=10B; I_C=4mA; P_D=30mBT; h_{21}=30...200;$ $f_T=6200MГц$	C	E	B	E
REs	BFP280	SIEM	NPN	$V_{CB0}=10B; I_C=10mA; P_D=80mBT; h_{21}=30...200;$ $f_T=7000MГц$	C	E	B	E
RFs	BFP181	SIEM	NPN	$V_{CB0}=20B; I_C=20mA; P_D=175mBT; h_{21}=50...200;$ $f_T=8000MГц$	C	E	B	E
RFs	BFP181R	SIEM	NPN	$V_{CB0}=20B; I_C=20mA; P_D=175mBT; h_{21}=50...200;$ $f_T>8000MГц$	C	E	B	E
RGs	BFP182	SIEM	NPN	$V_{CB0}=20B; I_C=35mA; P_D=250mBT; h_{21}=50...200;$ $f_T>8000MГц$	C	E	B	E
RGs	BFP182R	SIEM	NPN	$V_{CB0}=20B; I_C=35mA; P_D=250mBT; h_{21}=50...200;$ $f_T>8000MГц$	C	E	B	E

SOT143, TO-253(продолжение)

Код	Типономинал	Фирма	Функция	Особенности	Цоколевка			
					1	2	3	4
RHs	BFP183	SIEM	NPN	$V_{CB0}=20В; I_C=65mA; P_D=450mВт; h_{21}=50...200;$ $f_T=8000MГц$	C	E	B	E
RHs	BFP183R	SIEM	NPN	$V_{CB0}=20В; I_C=65mA; P_D=250mВт; h_{21}=50...200;$ $f_T>8000MГц$	C	E	B	E
RKs	BFP194	SIEM	PNP	$V_{CB0}=20В; I_C=100mA; P_D=700mВт; h_{21}=20...150;$ $f_T=5000MГц$	C	E	B	E
RLs	BFP196	SIEM	NPN	$V_{CB0}=20В; I_C=100mA; P_D=700mВт; h_{21}=50...200;$ $f_T=7500MГц$	C	E	B	E
S4	BBY62	PHIL	2xBD	$V_R<30В; I_F<20mA; C_{1V}=16 пФ; C_{28V}=1.6...2 пФ;$ $C_{1V}/C_{28V}=8.3$	K1	K2	A2	A1
S5	BAT15-099	SIEM	2xSHD	$V_R<4В; I_F<110mA; V_F(I_F=10mA)<0.32В;$ $C_D<0.35пФ$	K1	A2	K2	A1
S6	BAT15-099R	SIEM	4xSHD	$V_R<4В; I_F<110mA; V_F(I_F=10mA)<0.32В;$ $C_D<0.38пФ$	K1 A4	A3 K2	K4 A2	A1 K3
S8	BAT14-099R	SIEM	4xSHD	$V_R<4В; I_F<90mA; V_F(I_F=10mA)<0.48В;$ $C_D<0.38пФ$	K1 A4	A3 K2	K4 A2	A1 K3
S9	BAT14-099	SIEM	2xSHD	$V_R<4В; I_F<90mA; V_F(I_F=10mA)<0.55В;$ $C_D<0.35пФ$	K1	A2	K2	A1
SN	BAT63-099R	SIEM	4xSHD	$I_F<50A; V_F(I_F=1mA)<0.3В; C_D<1.1пФ$	A3 K1	A4 K2	K3 A2	A1 C4
T5	HSMS-2865	HP	2xSHD	$V_{BR}>5В; V_F(I_F=30mA)<0.6В; C_D<0.30 пФ; R_D=100M$	K1	K2	A2	A1

SOT23
SOD23

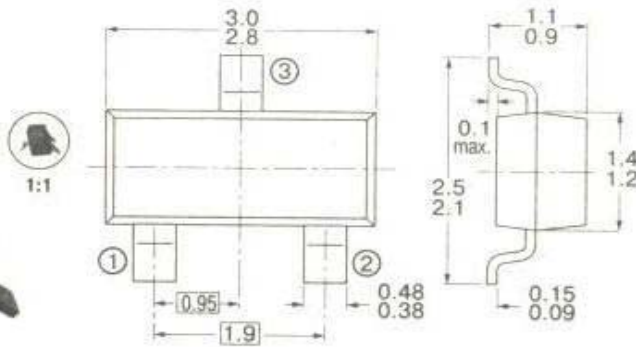

Код	Типономинал	Фирма	Функция	Особенности	Цоколевка		
					1	2	3
1A	TMPT3904	ALLG	NPN	$V_{CB0}=60B; I_{CB0}<50H_A; h_{21}=100...300; V_{CE(sat)}<0.2B; f_T>300MГц$	B	E	C
1A	BC846A	CDIL	NPN	$V_{CB0}=80B; I_C=100M_A; P_D=250mB_T; h_{21}=110...220; f_T>100MГц$	B	E	C
1A	BC846CLT1	MOT	NPN	$V_{CB0}=80B; I_C=100M_A; P_D=300mB_T; h_{21}=110...220; f_T>100MГц$	B	E	C
1A	KST3904	SAMS	PNP	$V_{CB0}=60B; I_C=200M_A; P_D=350mB_T; h_{21}=100...300; f_T>300MГц$	B	E	C
1A	BC846A	TOSH	NPN	$V_{CB0}=80B; I_C=100M_A; P_D=150mB_T; h_{21}=110...220; f_T=300MГц$	B	E	C
1A	MMBT3904	VISH	NPN	$V_{CB0}=60B; I_C=100M_A; P_D=200mB_T; h_{21}=100...300; f_T>300MГц$	B	E	C
1A	BC846A	VISH	NPN	$V_{CB0}=80B; I_C=100M_A; P_D=310mB_T; h_{21}=110...220; f_T>300MГц$	B	E	C
1A	FMMT3904	ZETEX	NPN	$V_{CB0}=60B; I_C=200M_A; P_D=330mB_T; h_{21}=100...300; f_T>300MГц$	B	E	C
1AM	MMBT3904LT1	MOT	NPN	$V_{CB0}=60B; I_C=200M_A; P_D=300mB_T; h_{21}=100...300; f_T>200MГц$	B	E	C
1Ap	BC846A	PHIL	NPN	$V_{CB0}=80B; I_C=100M_A; P_D=250mB_T; h_{21}=110...220; f_T>100MГц$	B	E	C
1AR	BC846AR	PHIL	NPN	$V_{CB0}=65B; I_C=200M_A; P_D=310mB_T; h_{21}=220; f_T>300MГц$	E	B	C
1As	BC846A	SIEM	NPN	$V_{CB0}=80B; I_C=100M_A; P_D=330mB_T; h_{21}=110...220; f_T=250MГц$	B	E	C
1B	TMPT2222	ALLG	NPN	$V_{CB0}=60B; I_{CB0}<10H_A; h_{21}=100...300; V_{CE(sat)}<0.4B; f_T>250MГц$	B	E	C
1B	BC846B	CDIL	NPN	$V_{CB0}=80B; I_C=100M_A; P_D=250mB_T; h_{21}=200...450; f_T>100MГц$	B	E	C
1B	BC846BLT1	MOT	NPN	$V_{CB0}=80B; I_C=100M_A; P_D=300mB_T; h_{21}=200...450; f_T>100MГц$	B	E	C
1B	KST2222	SAMS	NPN	$V_{CB0}=60B; I_C=600M_A; P_D=350mB_T; h_{21}>75; f_T>250MГц$	B	E	C
1B	BC846B	TOSH	NPN	$V_{CB0}=80B; I_C=100M_A; P_D=150mB_T; h_{21}=200...450; f_T=300MГц$	B	E	C
1B	BC846B	VISH	NPN	$V_{CB0}=80B; I_C=100M_A; P_D=310mB_T; h_{21}=200...450; f_T>300MГц$	B	E	C
1B	BC846B	ZETEX	NPN	$V_{CB0}=80B; I_C=100M_A; P_D=330mB_T; h_{21}=200...450; f_T>300MГц$	B	E	C
1Bp	BC846B	PHIL	NPN	$V_{CB0}=80B; I_C=100M_A; P_D=250mB_T; h_{21}=200...450; f_T>100MГц$	B	E	C
1BR	BC846AR	PHIL	NPN	$V_{CB0}=65B; I_C=100M_A; P_D=310mB_T; h_{21}=330; f_T>300MГц$	E	B	C
1Bs	BC846A	SIEM	NPN	$V_{CB0}=80B; I_C=100M_A; P_D=330mB_T; h_{21}=200...450; f_T=250MГц$	B	E	C
1BZ	FMMT2222	ZETEX	NPN	$V_{CB0}=60B; I_C=600M_A; P_D=330mB_T; h_{21}=100...300; f_T>250MГц$	B	E	C
1C	KST20	SAMS	NPN	$V_{CB0}=40B; I_C=100M_A; P_D=350mB_T; h_{21}=40...400; f_T>125MГц$	B	E	C
1C	FMMTA20	ZETEX	NPN	$V_{CB0}=40B; I_C=100M_A; P_D=350mB_T; h_{21}=40...400; f_T>125MГц$	B	E	C
1D	TMPTA42	ALLEG	NPN	$V_{CB0}=300B; I_{CB0}<100H_A; h_{21}>40; V_{CE(sat)}<0.5B; f_T>50MГц$	B	E	C
1D	BC846	CDIL	NPN	$V_{CB0}=80B; I_C=100M_A; P_D=250mB_T; h_{21}=110...450; f_T>100MГц$	B	E	C
1D	KST42	SAMS	NPN	$V_{CB0}=300B; I_C=500M_A; P_D=350mB_T; h_{21}>40; f_T>50MГц$	B	E	C
1D	MBTA42	TOSH	NPN	$V_{CB0}=300B; I_C=500M_A; P_D=250mB_T; h_{21}>40; f_T>50MГц$	B	E	C
1D	SMBTA20	VISH	NPN	$V_{CB0}=40B; I_C=100M_A; P_D=330mB_T; h_{21}=40...400; f_T>125MГц$	B	E	C
1D	MMBTA42	VISH	NPN	$V_{CB0}=300B; I_C=200M_A; P_D=350mB_T; h_{21}>25; f_T>50MГц$	B	E	C
1Dp	BC846	PHIL	NPN	$V_{CB0}=80B; I_C=100M_A; P_D=250mB_T; h_{21}=110...450; f_T>100MГц$	B	E	C
1E	TMPTA43	ALLEG	NPN	$V_{CB0}=200B; I_{CB0}<100H_A; h_{21}>40; V_{CE(sat)}<0.5B; f_T>50MГц$	B	E	C
1E	BC847A	CDIL	NPN	$V_{CB0}=50B; I_C=100M_A; P_D=150mB_T; h_{21}=110...220; f_T>300MГц$	B	E	C
1E	BC847ALT1	MOT	NPN	$V_{CB0}=50B; I_C=100M_A; P_D=300mB_T; h_{21}=110...220; f_T>100MГц$	B	E	C
1E	KST43	SAMS	NPN	$V_{CB0}=200B; I_C=500M_A; P_D=350mB_T; h_{21}>40; f_T>50MГц$	B	E	C
1E	BC847A	TOSH	NPN	$V_{CB0}=50B; I_C=100M_A; P_D=150mB_T; h_{21}=110...220; f_T=300MГц$	B	E	C
1E	BC847A	VISH	NPN	$V_{CB0}=50B; I_C=100M_A; P_D=310mB_T; h_{21}=110...220; f_T>300MГц$	B	E	C
1E	FMMTA43	ZETEX	NPN	$V_{CB0}=200B; I_C=200M_A; P_D=330mB_T; h_{21}=50...200; f_T>50MГц$	B	E	C
1Ep	BC847A	PHIL	NPN	$V_{CB0}=50B; I_C=100M_A; P_D=250mB_T; h_{21}=110...220; f_T>100MГц$	B	E	C
1ER	BC847AR	PHIL	NPN	$V_{CB0}=45B; I_C=100M_A; P_D=310mB_T; h_{21}=220; f_T>300MГц$	E	B	C
1Es	BC847A	SIEM	NPN	$V_{CB0}=50B; I_C=100M_A; P_D=330mB_T; h_{21}=110...220; f_T=250MГц$	B	E	C
1F	BC847B	CDIL	NPN	$V_{CB0}=50B; I_C=100M_A; P_D=150mB_T; h_{21}=200...450; f_T>300MГц$	B	E	C
1F	BC847BLT1	MOT	NPN	$V_{CB0}=50B; I_C=100M_A; P_D=300mB_T; h_{21}=200...450; f_T>100MГц$	B	E	C
1F	KST5550	SAMS	NPN	$V_{CB0}=160B; I_C=600M_A; P_D=350mB_T; h_{21}=60...250; f_T>150MГц$	B	E	C
1F	BC847B	TOSH	NPN	$V_{CB0}=50B; I_C=100M_A; P_D=150mB_T; h_{21}=200...450; f_T=300MГц$	B	E	C
1F	BC847B	VISH	NPN	$V_{CB0}=50B; I_C=100M_A; P_D=310mB_T; h_{21}=200...450; f_T>300MГц$	B	E	C
1F	BC847B	ZETEX	NPN	$V_{CB0}=50B; I_C=100M_A; P_D=330mB_T; h_{21}=200...450; f_T>300MГц$	B	E	C
1FF	CMPT5551	CENTS	NPN	$V_{CB0}=180B; I_C=600M_A; P_D=350mB_T; h_{21}=80...250; f_T=100...300MГц$	B	E	C
1Fp	BC847B	PHIL	NPN	$V_{CB0}=50B; I_C=100M_A; P_D=250mB_T; h_{21}=200...450; f_T>100MГц$	B	E	C
1FR	BC847BR	PHIL	NPN	$V_{CB0}=45B; I_C=100M_A; P_D=310mB_T; h_{21}=330; f_T>300MГц$	E	B	C
1Fs	BC847B	SIEM	NPN	$V_{CB0}=50B; I_C=100M_A; P_D=330mB_T; h_{21}=200...450; f_T=250MГц$	B	E	C
1G	TMPTA06	ALLEG	NPN	$V_{CB0}=80B; I_{CB0}<100H_A; h_{21}>50; V_{CE(sat)}<0.25B; f_T>100MГц$	B	E	C

SOT23, SOD23 (продолжение)

Код	Типономинал	Фирма	Функция	Особенности	Цоколевка		
					1	2	3
1G	BC847C	CDIL	NPN	$V_{CB0}=50B; I_C=100mA; P_D=310mB; h_{21}=420...800; f_T>300MГц$	B	E	C
1G	BC847CLT1	MOT	NPN	$V_{CB0}=50B; I_C=100mA; P_D=300mB; h_{21}=420...800; f_T>100MГц$	B	E	C
1G	KST06	SAMS	NPN	$V_{CB0}=80B; I_C=500mA; P_D=350mB; h_{21}>50; f_T>100MГц$	B	E	C
1G	BC847C	VISH	NPN	$V_{CB0}=50B; I_C=100mA; P_D=310mB; h_{21}=420...800; f_T>300MГц$	B	E	C
1G	MMBTA06	VISH	NPN	$V_{CB0}=80B; I_C=300mA; P_D=350mB; h_{21}>50; f_T>100MГц$	B	E	C
1G	BC847C	ZETEX	NPN	$V_{CB0}=50B; I_C=100mA; P_D=330mB; h_{21}=420...800; f_T>300MГц$	B	E	C
1G	FMMTA06	ZETEX	NPN	$V_{CB0}=80B; I_C=500mA; P_D=330mB; h_{21}>50; f_T>100MГц$	B	E	C
1Gp	BC847C	PHIL	NPN	$V_{CB0}=50B; I_C=100mA; P_D=250mB; h_{21}=420...800; f_T>100MГц$	B	E	C
1GR	BC847CR	PHIL	NPN	$V_{CB0}=45B; I_C=100mA; P_D=310mB; h_{21}=600; f_T>300MГц$	E	B	C
1Gs	BC847C	SIEM	NPN	$V_{CB0}=50B; I_C=100mA; P_D=330mB; h_{21}=420...800; f_T=250MГц$	B	E	C
1GZ	BC847C	ZETEX	NPN	$V_{CB0}=50B; I_C=100mA; P_D=330mB; h_{21}=420...800; f_T>300MГц$	B	E	C
1H	TMPTA05	ALLEG	NPN	$V_{CB0}=60B; I_{CB0}<100μA; h_{21}>50; V_{CE(sat)}<0.25B; f_T>100MГц$	B	E	C
1H	BC847	CDIL	NPN	$V_{CB0}=50B; I_C=100mA; P_D=250mB; h_{21}=110...800; f_T>100MГц$	B	E	C
1H	KST05	SAMS	NPN	$V_{CB0}=60B; I_C=500mA; P_D=350mB; h_{21}>50; f_T>100MГц$	B	E	C
1H	MMBTA05	VISH	NPN	$V_{CB0}=60B; I_C=300mA; P_D=350mB; h_{21}>50; f_T>100MГц$	B	E	C
1H	FMMTA05	ZETEX	NPN	$V_{CB0}=60B; I_C=500mA; P_D=330mB; h_{21}>50; f_T>100MГц$	B	E	C
1Hp	BC847	PHIL	NPN	$V_{CB0}=50B; I_C=100mA; P_D=250mB; h_{21}=110...800; f_T>100MГц$	B	E	C
1J	BC848A	CDIL	NPN	$V_{CB0}=30B; I_C=100mA; P_D=150mB; h_{21}=110...220; f_T>300MГц$	B	E	C
1J	BC848ALT1	MOT	NPN	$V_{CB0}=30B; I_C=100mA; P_D=300mB; h_{21}=110...220; f_T>100MГц$	B	E	C
1J	BC848A	TOSH	NPN	$V_{CB0}=30B; I_C=100mA; P_D=150mB; h_{21}=110...220; f_T=300MГц$	B	E	C
1J	BC848A	VISH	NPN	$V_{CB0}=30B; I_C=100mA; P_D=310mB; h_{21}=110...220; f_T>300MГц$	B	E	C
1J	FMMT2369	ZETEX	NPN	$V_{CB0}=40B; I_C=200mA; P_D=330mB; h_{21}=40...120;$	B	E	C
1JA	MMBT2369ALT1	MOT	NPN	$V_{CB0}=40B; I_C=200mA; P_D=300mB; h_{21}>40;$	B	E	C
1Jp	BC848A	PHIL	NPN	$V_{CB0}=30B; I_C=100mA; P_D=250mB; h_{21}=110...220; f_T>100MГц$	B	E	C
1Js	BC848A	SIEM	NPN	$V_{CB0}=30B; I_C=100mA; P_D=330mB; h_{21}=110...220; f_T=250MГц$	B	E	C
1JZ	BC848A	ZETEX	NPN	$V_{CB0}=30B; I_C=100mA; P_D=330mB; h_{21}=110...220; f_T>300MГц$	B	E	C
1K	BC848B	CDIL	NPN	$V_{CB0}=30B; I_C=100mA; P_D=310mB; h_{21}=200...450; f_T>300MГц$	B	E	C
1K	BC848BLT1	MOT	NPN	$V_{CB0}=30B; I_C=100mA; P_D=300mB; h_{21}=200...450; f_T>100MГц$	E	B	C
1K	KST6428	SAMS	NPN	$V_{CB0}=60B; I_C=200mA; P_D=350mB; h_{21}=250...650; f_T=100...700MГц$	B	E	C
1K	BC848B	TOSH	NPN	$V_{CB0}=30B; I_C=100mA; P_D=150mB; h_{21}=200...450; f_T=300MГц$	B	E	C
1K	BC848B	VISH	NPN	$V_{CB0}=30B; I_C=100mA; P_D=310mB; h_{21}=200...450; f_T>300MГц$	B	E	C
1K	BC848B	ZETEX	NPN	$V_{CB0}=30B; I_C=100mA; P_D=330mB; h_{21}=200...450; f_T>300MГц$	B	E	C
1Kp	BC848B	PHIL	NPN	$V_{CB0}=30B; I_C=100mA; P_D=250mB; h_{21}=200...450; f_T>100MГц$	B	E	C
1KR	BC848BR	PHIL	NPN	$V_{CB0}=30B; I_C=100mA; P_D=310mB; h_{21}=330; f_T>300MГц$	E	B	C
1Ks	BC848B	SIEM	NPN	$V_{CB0}=30B; I_C=100mA; P_D=330mB; h_{21}=200...450; f_T=250MГц$	B	E	C
1KZ	FMMT4400	ZETEX	NPN	$V_{CB0}=60B; I_C=600mA; P_D=330mB; h_{21}=50...150; f_T>200MГц$	B	E	C
1L	BC848C	CDIL	NPN	$V_{CB0}=30B; I_C=100mA; P_D=310mB; h_{21}=420...800; f_T>300MГц$	B	E	C
1L	BC848CLT1	MOT	NPN	$V_{CB0}=30B; I_C=100mA; P_D=300mB; h_{21}=420...800; f_T>100MГц$	B	E	C
1L	BC848C	TOSH	NPN	$V_{CB0}=30B; I_C=100mA; P_D=150mB; h_{21}=420...800; f_T=300MГц$	B	E	C
1L	BC848C	VISH	NPN	$V_{CB0}=30B; I_C=100mA; P_D=310mB; h_{21}=420...800; f_T>300MГц$	B	E	C
1L	FMMT4401	ZETEX	NPN	$V_{CB0}=60B; I_C=600mA; P_D=330mB; h_{21}=100...300; f_T>250MГц$	B	E	C
1Lp	BC848C	PHIL	NPN	$V_{CB0}=30B; I_C=100mA; P_D=250mB; h_{21}=420...800; f_T>100MГц$	B	E	C
1LR	BC848CR	PHIL	NPN	$V_{CB0}=30B; I_C=100mA; P_D=310mB; h_{21}=600; f_T>300MГц$	E	B	C
1Ls	BC848C	SIEM	NPN	$V_{CB0}=30B; I_C=100mA; P_D=330mB; h_{21}=420...800; f_T=250MГц$	B	E	C
1M	BC848	CDIL	NPN	$V_{CB0}=30B; I_C=100mA; P_D=250mB; h_{21}=110...800; f_T>100MГц$	B	E	C
1M	MMBTA13LT1	MOT	NPN	$V_{CB0}=30B; I_C=300mA; P_D=300mB; h_{21}>5000; f_T>125MГц$	B	E	C
1M	KST13	SAMS	NPN	$V_{CB0}=30B; I_C=300mA; P_D=350mB; h_{21}>5000; f_T>125MГц$	B	E	C
1M	MMBTA13	VISH	NPN	$V_{CB0}=30B; I_C=300mA; P_D=300mB; h_{21}>10000; f_T<125MГц$	E	B	C
1M	FMMT13	ZETEX	NPN	$V_{CB0}=40B; I_C=300mA; P_D=300mB; h_{21}>10000$	B	E	C
1Mp	BC848	PHIL	NPN	$V_{CB0}=30B; I_C=100mA; P_D=250mB; h_{21}=110...800; f_T>100MГц$	B	E	C
1N	TMPTA14	ALLEG	NPN	$V_{CB0}=30B; I_{CB0}<100μA; h_{21}>20k; V_{CE(sat)}<1.5B; f_T>125MГц$	B	E	C
1N	MMBTA14LT1	MOT	NPN	$V_{CB0}=30B; I_C=300mA; P_D=300mB; h_{21}>10000; f_T>125MГц$	B	E	C
1N	KST14	SAMS	NPN	$V_{CB0}=30B; I_C=300mA; P_D=350mB; h_{21}>10000; f_T>125MГц$	B	E	C
1N	MMBTA14	VISH	NPN	$V_{CB0}=30B; I_C=300mA; P_D=350mB; h_{21}<20000; f_T<125MГц$	B	E	C
1N	MMBT3904	VISH	NPN	$V_{CB0}=60B; I_C=100mA; P_D=200mB; h_{21}=100...300; f_T>300MГц$	B	E	C
1N	FMMT14	ZETEX	NPN	$V_{CB0}=40B; I_C=300mA; P_D=330mB; h_{21}>20000$	B	E	C
1P	TMPT2222A	ALLEG	NPN	$V_{CB0}=75B; I_{CB0}<10μA; h_{21}=100...300; V_{CE(sat)}<0.3B; f_T>250MГц$	B	E	C
1P	MMBT2222ALT1	MOT	NPN	$V_{CB0}=75B; I_C=600mA; P_D=300mB; h_{21}>35; f_T>300MГц$	B	E	C
1P	KST2222A	SAMS	NPN	$V_{CB0}=75B; I_C=600mA; P_D=350mB; h_{21}>75; f_T>300MГц$	B	E	C
1P	MBT2222A	TOSH	NPN	$V_{CB0}=75B; I_C=600mA; P_D=250mB; h_{21}>40; f_T=300MГц$	B	E	C
1P	MMBT2222A	VISH	NPN	$V_{CB0}=50B; I_C=800mA; P_D=200mB; h_{21}=100...300; f_T>200MГц$	B	E	C
1P	FMMT2222A	ZETEX	NPN	$V_{CB0}=75B; I_C=600mA; P_D=330mB; h_{21}=120...360; f_T>300MГц$	B	E	C
1Q	TMPT5088	ALLEG	NPN	$V_{CB0}=35B; I_{CB0}<50μA; h_{21}=300...900; V_{CE(sat)}<0.5B$	B	E	C

SOT23, SOD23 (продолжение)

Код	Типономинал	Фирма	Функция	Особенности	Цоколевка		
					1	2	3
1Q	KST5088	SAMS	NPN	$V_{CB0}=35B; I_C=50_{MA}; P_D=350_{MBT}; h_{21}=300...900; f_T>50_{MGU}$	B	E	C
1Q	MMBT5088	VISH	NPN	$V_{CB0}=35B; I_C=100_{MA}; P_D=350_{MBT}; h_{21}=300...900; f_T>50_{MGU}$	B	E	C
1Q	FMMT5088	ZETEX	NPN	$V_{CB0}=35B; I_C=50_{MA}; P_D=330_{MBT}; h_{21}=300...900; f_T>50_{MGU}$	B	E	C
1R	TMPT5089	ALLEG	NPN	$V_{CB0}=30B; I_{CB0}<50_{HA}; h_{21}=400...1200; V_{CE(sat)}<0.5B$	B	E	C
1R	KST5089	SAMS	NPN	$V_{CB0}=35B; I_C=50_{MA}; P_D=350_{MBT}; h_{21}=400...1200; f_T>50_{MGU}$	B	E	C
1R	MMBT5089	VISH	NPN	$V_{CB0}=30B; I_C=100_{MA}; P_D=350_{MBT}; h_{21}=400...1200; f_T>50_{MGU}$	B	E	C
1R	FMMT5089	ZETEX	NPN	$V_{CB0}=30B; I_C=50_{MA}; P_D=330_{MBT}; h_{21}=400...1200; f_T>50_{MGU}$	B	E	C
1T1	MMST5101	ROHM	PNP	$V_{CB0}=-60B; I_C=-200_{MA}; h_{21}=200...400; f_T>125_{MGU}$	B	E	C
1U	KST2484	SAMS	NPN	$V_{CB0}=-60B; I_C=50_{MA}; P_D=350_{MBT}; h_{21}>250$	B	E	C
1V	TMPT6427	ALLEG	NPN	$V_{CB0}=40B; I_{CB0}<50_{HA}; h_{21}=10000...100000; V_{CE(sat)}<1.2B$ $f_T>130_{MGU}$	B	E	C
1V	BF820	CDIL	NPN	$V_{CB0}=300B; I_C=50_{MA}; P_D=250_{MBT}; h_{21}>50; f_T>60_{MGU}$	B	E	C
1Vp	BF820	PHIL	NPN	$V_{CB0}=300B; I_C=50_{MA}; P_D=250_{MBT}; h_{21}>50; f_T>60_{MGU}$	B	E	C
1W	BF821	CDIL	PNP	$V_{CB0}=-300B; I_C=-50_{MA}; P_D=250_{MBT}; h_{21}>50; f_T>60_{MGU}$	B	E	C
1W	FMMT3903	ZETEX	NPN	$V_{CB0}=600B; I_C=200_{MA}; P_D=330_{MBT}; h_{21}=50...150; f_T>250_{MGU}$	B	E	C
1Wp	BF821	PHIL	PNP	$V_{CB0}=-300B; I_C=-50_{MA}; P_D=250_{MBT}; h_{21}>50; f_T>60_{MGU}$	B	E	C
1X	BF822	CDIL	NPN	$V_{CB0}=250B; I_C=50_{MA}; P_D=250_{MBT}; h_{21}>50; f_T>60_{MGU}$	B	E	C
1Xp	BF822	PHIL	NPN	$V_{CB0}=250B; I_C=50_{MA}; P_D=250_{MBT}; h_{21}>50; f_T>60_{MGU}$	B	E	C
1Y	BF823	CDIL	PNP	$V_{CB0}=-250B; I_C=-50_{MA}; P_D=250_{MBT}; h_{21}>50; f_T>60_{MGU}$	B	E	C
1Y	KST3903	SAMS	PNP	$V_{CB0}=-60B; I_C=-200_{MA}; P_D=350_{MBT}; h_{21}=50...150; f_T>250_{MGU}$	B	E	C
1Yp	BF823	PHIL	PNP	$V_{CB0}=-250B; I_C=-50_{MA}; P_D=250_{MBT}; h_{21}>50; f_T>60_{MGU}$	B	E	C
1Z	BAS70-06	ZETEX	2xSH D	$V_R<70B; V_F(I_F=1_{MA})<0.41 B; I_R<0.2_{mKA}; C_D<2.0_{пФ};$	K1	K2	A1 A2
12E	ZC2812E	ZETEX	2xSH D	$V_R<15B; V_F(I_F=1_{MA})<0.41 B; I_R<0.1_{mKA}; C_D<1.2_{пФ};$	A1	K2	K1 A2
13	BAS125	SIEM	SHD	$V_R<25B; I_F<100_{MA}; V_F(I_F=35_{MA})<0.9B; I_R<1.0_{mKA}; C_D<1.1_{пФ};$	A	nc	K
13E	ZC2813E	ZETEX	2xSH D	$V_R<15B; V_F(I_F=1_{MA})<0.41 B; I_R<0.1_{mKA}; C_D<1.2_{пФ};$	A1	K2	K1 A2
14	BAS125-04	SIEM	2xSH D	$V_R<25B; I_F<100_{MA}; V_F(I_F=35_{MA})<0.9B; I_R<1.0_{mKA}; C_D<1.1_{пФ};$	A1	K2	K1 A2
15	BAS125-05	SIEM	2xSH D	$V_R<25B; I_F<100_{MA}; V_F(I_F=35_{MA})<0.9B; I_R<1.0_{mKA}; C_D<1.1_{пФ};$	A1	K2	K1 A2
16	BAS125-06	SIEM	2xSH D	$V_R<25B; I_F<100_{MA}; V_F(I_F=35_{MA})<0.9B; I_R<1.0_{mKA}; C_D<1.1_{пФ};$	K1	K2	A1 A2
179	FMMT5179	ZETEX	NPN	$V_{CB0}=20B; I_C=50_{MA}; P_D=330_{MBT}; h_{21}=25...250; f_T>1100_{MGU}$	B	E	C
18A	CMPZ5221B	CENTS	DZ	$V_Z(I_{ZT}=20_{MA})=2.28...2.52B; I_L(V_R=1.0B)<100_{mKA}; Z_{ZT}(I_{ZT}=20_{MA})<30_{OM}$	A	nc	K
18B	CMPZ5222B	CENTS	DZ	$V_Z(I_{ZT}=20_{MA})=2.375...2.625B; I_L(V_R=1.0B)<100_{mKA}; Z_{ZT}(I_{ZT}=20_{MA})<30_{OM}$	A	nc	K
18C	CMPZ5223B	CENTS	DZ	$V_Z(I_{ZT}=20_{MA})=2.565...2.835B; I_L(V_R=1.0B)<75_{mKA}; Z_{ZT}(I_{ZT}=20_{MA})<30_{OM}$	A	nc	K
18D	CMPZ5224B	CENTS	DZ	$V_Z(I_{ZT}=20_{MA})=2.66...2.94B; I_L(V_R=1.0B)<75_{mKA}; Z_{ZT}(I_{ZT}=20_{MA})<30_{OM}$	A	nc	K
18E	CMPZ5225B	CENTS	DZ	$V_Z(I_{ZT}=20_{MA})=2.85...3.15B; I_L(V_R=1.0B)<50_{mKA}; Z_{ZT}(I_{ZT}=20_{MA})<29_{OM}$	A	nc	K
2A	TMPT3906	ALLEG	PNP	$V_{CB0}=-40B; h_{21}=100...300; V_{CE(sat)}<0.25B f_T>250_{MGU}$	B	E	C
2A	MMBT3906LT1	MOT	PNP	$V_{CB0}=-40B; I_C=-200_{MA}; P_D=300_{MBT}; h_{21}=100...300; f_T>250_{MGU}$	B	E	C
2A	KST3906	SAMS	PNP	$V_{CB0}=-40B; I_C=-200_{MA}; P_D=350_{MBT}; h_{21}=100...300; f_T>250_{MGU}$	B	E	C
2A	MMBT3906	VISH	PNP	$V_{CB0}=-40B; I_C=-100_{MA}; P_D=200_{MBT}; h_{21}=100...300; f_T>250_{MGU}$	B	E	C
2A	FMMT3906	ZETEX	PNP	$V_{CB0}=-40B; I_C=-200_{MA}; P_D=330_{MBT}; h_{21}=100...300; f_T>250_{MGU}$	B	E	C
2B	TMPT2907	ALLEG	PNP	$V_{CB0}=-60B; I_{CB0}<20_{HA}; h_{21}=100...300; V_{CE(sat)}<0.4B$ $f_T>200_{MGU}$	B	E	C
2B	BC849B	CDIL	NPN	$V_{CB0}=30B; I_C=100_{MA}; P_D=330_{MBT}; h_{21}=200...450; f_T>300_{MGU}$	B	E	C
2B	KST2907	SAMS	PNP	$V_{CB0}=-60B; I_C=-600_{MA}; P_D=350_{MBT}; h_{21}>75; f_T>200_{MGU}$	B	E	C
2B	BC849C	TOSH	NPN	$V_{CB0}=30B; I_C=100_{MA}; P_D=150_{MBT}; h_{21}=200...450; f_T>300_{MGU}$	B	E	C
2B	MMBT2907	VISH	PNP	$V_{CB0}=-40B; I_C=-500_{MA}; P_D=310_{MBT}; h_{21}=100...300; f_T>200_{MGU}$	B	E	C
2B	BC849B	ZETEX	NPN	$V_{CB0}=30B; I_C=100_{MA}; P_D=330_{MBT}; h_{21}=200...450; f_T>300_{MGU}$	B	E	C
2Bp	BC849B	PHIL	NPN	$V_{CB0}=30B; I_C=100_{MA}; P_D=250_{MBT}; h_{21}=200...450; f_T>100_{MGU}$	B	E	C
2BR	BC849BR	PHIL	NPN	$V_{CB0}=30B; I_C=100_{MA}; P_D=310_{MBT}; h_{21}=330; f_T>300_{MGU}$	E	B	C
2Bs	BC849B	SIEM	NPN	$V_{CB0}=30B; I_C=100_{MA}; P_D=330_{MBT}; h_{21}=200...450; f_T>250_{MGU}$	B	E	C
2BZ	FMMT2907	ZETEX	PNP	$V_{CB0}=-60B; I_C=-600_{MA}; P_D=330_{MBT}; h_{21}=100...300; f_T>200_{MGU}$	B	E	C
2C	TMPTA70	ALLEG	PNP	$I_{CB0}<100_{HA}; h_{21}=40...100; V_{CE(sat)}<0.25B f_T>125_{MGU}$	B	E	C

SOT23, SOD23 (продолжение)

Код	Типономинал	Фирма	Функция	Особенности	Цоколевка		
					1	2	3
2C	BC849C	CDIL	NPN	$V_{CB0}=30B; I_C=100mA; P_D=330mBт; h_{21}=420...800; f_T>300MГц$	B	E	C
2C	BC849C	TOSH	NPN	$V_{CB0}=30B; I_C=100mA; P_D=150mBт; h_{21}=420...800; f_T=300MГц$	B	E	C
2C	BC849C	ZETEX	NPN	$V_{CB0}=30B; I_C=100mA; P_D=150mBт; h_{21}=420...800; f_T>300MГц$	B	E	C
2Cp	BC849C	PHIL	NPN	$V_{CB0}=30B; I_C=100mA; P_D=250mBт; h_{21}=420...800; f_T>100MГц$	B	E	C
2CR	BC849CR	PHIL	NPN	$V_{CB0}=30B; I_C=100mA; P_D=310mBт; h_{21}=600; f_T>300MГц$	E	B	C
2Cs	BC849C	SIEM	NPN	$V_{CB0}=30B; I_C=100mA; P_D=330mBт; h_{21}=420...800; f_T=250MГц$	B	E	C
CZ	FMMT70	ZETEX	PNP	$V_{CB0}=-40B; I_C=-100mA; P_D=330mBт; h_{21}=40...400; f_T>125MГц$	B	E	C
2D	BC849	CDIL	NPN	$V_{CB0}=30B; I_C=100mA; P_D=250mBт; h_{21}=200...800; f_T>100MГц$	B	E	C
2D	KST92	SAMS	PNP	$V_{CB0}=-300B; I_C=-500mA; P_D=350mBт; h_{21}>40; f_T>50MГц$	B	E	C
2D	MBTA92	TOSH	PNP	$V_{CB0}=-300B; I_C=-500mA; P_D=250mBт; h_{21}>40; f_T=50MГц$	B	E	C
2D	MMBT92	VISH	PNP	$V_{CB0}=-300B; I_C=-500mA; P_D=300mBт; h_{21}>40; f_T>50MГц$	B	E	C
2Dp	BC849	PHIL	NPN	$V_{CB0}=30B; I_C=100mA; P_D=250mBт; h_{21}=200...800; f_T>100MГц$	B	E	C
2E	KST92	SAMS	PNP	$V_{CB0}=-200B; I_C=-500mA; P_D=350mBт; h_{21}>40; f_T>50MГц$	B	E	C
2E	FMMT93	ZETEX	PNP	$V_{CB0}=-200B; I_C=-200mA; P_D=330mBт; h_{21}=30...150; f_T>50MГц$	B	E	C
2F	TMPT2907A	ALLEG	PNP	$V_{CB0}=-60B; I_{CB0}<10HA; h_{21}=100...300; V_{CE(sat)}<0.4B; f_T>200MГц$	B	E	C
2F	BC850B	CDIL	NPN	$V_{CB0}=-50B; I_C=100mA; P_D=250mBт; h_{21}=200...450; f_T>100MГц$	B	E	C
2F	MMBT2907AL T1	MOT	PNP	$V_{CB0}=-60B; I_C=-600mA; P_D=300mBт; h_{21}=100...300; f_T>200MГц$	B	E	C
2F	KST2907A	SAMS	PNP	$V_{CB0}=-60B; I_C=-600mA; P_D=350mBт; h_{21}=100...300; f_T>200MГц$	B	E	C
2F	MBTA2907A	TOSH	PNP	$V_{CB0}=-60B; I_C=-600mA; P_D=250mBт; h_{21}>50; f_T>200MГц$	B	E	C
2F	MMBT2907A	VISH	PNP	$V_{CB0}=-60B; I_C=-500mA; P_D=310mBт; h_{21}=75...300; f_T<200MГц$	B	E	C
2F	FMMT2907A	ZETEX	PNP	$V_{CB0}=-60B; I_C=-600mA; P_D=330mBт; h_{21}=100...300; f_T>200MГц$	B	E	C
2Fp	BC850B	PHIL	NPN	$V_{CB0}=50B; I_C=100mA; P_D=250mBт; h_{21}=200...450; f_T>100MГц$	B	E	C
2FR	BC850BR	PHIL	NPN	$V_{CB0}=45B; I_C=100mA; P_D=310mBт; h_{21}=330; f_T>300MГц$	E	B	C
2Fs	BC850B	SIEM	NPN	$V_{CB0}=50B; I_C=100mA; P_D=330mBт; h_{21}=200...450; f_T=250MГц$	B	E	C
2FZ	BC850B	ZETEX	NPN	$V_{CB0}=50B; I_C=100mA; P_D=330mBт; h_{21}=200...450; f_T>300MГц$	B	E	C
2G	TMPTA56	ALLEG	PNP	$V_{CB0}=-80B; I_{CB0}<100HA; h_{21}>50; V_{CE(sat)}<0.25B; f_T>50MГц$	B	E	C
2G	BC850C	CDIL	NPN	$V_{CB0}=50B; I_C=100mA; P_D=250mBт; h_{21}=420...800; f_T>100MГц$	B	E	C
2G	KST56	SAMS	PNP	$V_{CB0}=-80B; I_C=-500mA; P_D=350mBт; h_{21}>50; f_T>50MГц$	B	E	C
2G	MMBTA56	VISH	PNP	$V_{CB0}=-80B; I_C=-500mA; P_D=350mBт; h_{21}>50; f_T>50MГц$	B	E	C
2G	FMMTA56	ZETEX	PNP	$V_{CB0}=-80B; I_C=-500mA; P_D=330mBт; h_{21}>50; f_T>100MГц$	B	E	C
2Gp	BC850C	PHIL	NPN	$V_{CB0}=50B; I_C=100mA; P_D=250mBт; h_{21}=420...800; f_T>100MГц$	B	E	C
2GR	BC850CR	PHIL	NPN	$V_{CB0}=45B; I_C=100mA; P_D=310mBт; h_{21}=600; f_T>300MГц$	B	E	C
2Gs	BC850C	SIEM	NPN	$V_{CB0}=50B; I_C=100mA; P_D=330mBт; h_{21}=420...800; f_T=250MГц$	B	E	C
2H	TMPTA55	ALLEG	PNP	$V_{CB0}=-60B; I_{CB0}<100HA; h_{21}>50; V_{CE(sat)}<0.25B; f_T>50MГц$	B	E	C
2H	BC850	CDIL	NPN	$V_{CB0}=50B; I_C=100mA; P_D=250mBт; h_{21}=200...800; f_T>100MГц$	B	E	C
2H	KST55	SAMS	PNP	$V_{CB0}=-60B; I_C=-500mA; P_D=350mBт; h_{21}>50; f_T>50MГц$	B	E	C
2H	MMBTA55	VISH	PNP	$V_{CB0}=-60B; I_C=-500mA; P_D=225mBт; h_{21}=50; f_T>50MГц$	B	E	C
2H	FMMTA55	ZETEX	PNP	$V_{CB0}=-60B; I_C=-500mA; P_D=330mBт; h_{21}>50; f_T>100MГц$	B	E	C
2Hp	BC850	PHIL	NPN	$V_{CB0}=50B; I_C=100mA; P_D=250mBт; h_{21}=200...800; f_T>100MГц$	B	E	C
2J	MMBT3640L T1	MOT	PNP	$V_{CB0}=-12B; I_C=-80mA; P_D=300mBт; h_{21}=30...120; f_T>500MГц$	B	E	C
2K	FMMT4402	ZETEX	PNP	$V_{CB0}=-40B; I_C=-600mA; P_D=330mBт; h_{21}=50...150; f_T>150MГц$	B	E	C
2L	TMPT5401	ALLEG	PNP	$V_{CB0}=-160B; I_{CB0}<50HA; h_{21}=60...240; V_{CE(sat)}<0.2B; f_T>100MГц$	B	E	C
2L	KST5401	SAMS	PNP	$V_{CB0}=-160B; I_C=-500mA; P_D=350mBт; h_{21}=60...240; f_T>150MГц$	B	E	C
2L	MMBT5401	VISH	PNP	$V_{CB0}=-160B; I_C=-200mA; P_D=350mBт; h_{21}=60...240; f_T>100MГц$	B	E	C
2L	FMMT4403	ZETEX	PNP	$V_{CB0}=-40B; I_C=-600mA; P_D=330mBт; h_{21}=100...300; f_T>200MГц$	B	E	C
2m	FMMT5087	ZETEX	PNP	$V_{CB0}=-50B; I_C=-100mA; P_D=330mBт; h_{21}=250...800; f_T>40MГц$	B	E	C
2N	MMBT404AL T1	MOT	PNP	$V_{CB0}=-40B; I_C=-150mA; P_D=300mBт; h_{21}=100...400$	B	E	C
2P	TMPT5086	ALLEG	PNP	$V_{CB0}=-50B; I_{CB0}<50HA; h_{21}=150...500; V_{CE(sat)}<0.3B; f_T>40MГц$	B	E	C
2P	KST5086	SAMS	PNP	$V_{CB0}=-50B; I_C=-50mA; P_D=350mBт; h_{21}=150...500; f_T>40MГц$	B	E	C
2P	FMMT2222R	ZETEX	NPN	$V_{CB0}=60B; I_C=600mA; P_D=330mBт; h_{21}=120...360; f_T>250MГц$	B	E	C
2Q	TMPT5087	ALLEG	PNP	$V_{CB0}=-50B; I_{CB0}<50HA; h_{21}=250...800; V_{CE(sat)}<0.3B; f_T>40MГц$	B	E	C
2Q	KST5087	SAMS	PNP	$V_{CB0}=-50B; I_C=-50mA; P_D=350mBт; h_{21}=250...800; f_T>40MГц$	B	E	C
2Q	FMMT5209	ZETEX	NPN	$V_{CB0}=50B; I_C=50mA; P_D=330mBт; h_{21}=100...300; f_T>30MГц$	B	E	C
2R	FMMT5210	ZETEX	NPN	$V_{CB0}=50B; I_C=50mA; P_D=330mBт; h_{21}=200...600; f_T>30MГц$	B	E	C
2T	TMPT4403	ALLEG	PNP	$V_{CB0}=-40B; h_{21}=100...300; V_{CE(sat)}<0.4B; f_T>200MГц$	B	E	C
2T	MMBT4403L T1	MOT	PNP	$V_{CB0}=-40B; I_C=-600mA; P_D=300mBт; h_{21}=100...300; f_T>200MГц$	B	E	C
2T	KST4403	SAMS	PNP	$V_{CB0}=-60B; I_C=-600mA; P_D=350mBт; h_{21}=100...300; f_T>200MГц$	B	E	C
2T	MMBT4403	VISH	PNP	$V_{CB0}=-40B; I_C=-800mA; P_D=200mBт; h_{21}=100...300; f_T>200MГц$	B	E	C
2U	KST63	SAMS	PNP	$V_{CB0}=-30B; I_C=-500mA; P_D=350mBт; h_{21}>5000; f_T>125MГц$	B	E	C
2V	MMBTA64LT1	MOT	PNP	$V_{CB0}=-30B; I_C=-500mA; P_D=300mBт; h_{21}>10000; f_T>125MГц$	B	E	C
2V	KST64	SAMS	PNP	$V_{CB0}=-30B; I_C=-500mA; P_D=350mBт; h_{21}>10000; f_T>125MГц$	B	E	C

SOT23, SOD23 (продолжение)

Код	Типономинал	Фирма	Функция	Особенности	Цоколевка		
					1	2	3
2W	TMPT4402	ALLEG	PNP	$V_{CB0}=-40B; h_{21}=50 \dots 150; V_{CE(sat)}<0.4B; f_T>150MГц$	B	E	C
2W	MMBT8599LT1	MOT	PNP	$V_{CB0}=-80B; I_C=-500mA; P_D=300mBт; h_{21}=100 \dots 300; f_T>150MГц$	B	E	C
2W	FMMT3905	ZETEX	PNP	$V_{CB0}=-40B; I_C=-200mA; P_D=330mBт; h_{21}=50 \dots 150; f_T>200MГц$	B	E	C
2X	TMPT4401	ALLEG	NPN	$V_{CB0}=-60B; I_{CB0}<100HA; h_{21}=100 \dots 300; V_{CE(sat)}<0.4B; f_T>250MГц$	B	E	C
2X	MMBT4401LT1	MOT	NPN	$V_{CB0}=60B; I_C=600mA; P_D=300mBт; h_{21}=100 \dots 300; f_T>250MГц$	B	E	C
2X	KST4401	SAMS	NPN	$V_{CB0}=60B; I_C=600mA; P_D=350mBт; h_{21}=100 \dots 300; f_T>250MГц$	B	E	C
2X	MMBT4401	VISH	NPN	$V_{CB0}=50B; I_C=800mA; P_D=200mBт; h_{21}=100 \dots 300; f_T>200MГц$	B	E	C
2Z	BAS70-04	ZETEX	2xSHD	$V_R<70B; V_F(I_F=1mA)<0.41B; I_R<0.2mA; C_D<2.0пФ;$	A1	K2	K1 A2
2Z5	BAS70-05	ZETEX	2xSHD	$V_R<70B; V_F(I_F=1mA)<0.41B; I_R<0.2mA; C_D<2.0пФ;$	A1	A2	K1 K2
305	AT-30533	HP	NPN	$V_{CB0}=11B; I_C=8mA; P_D=100mBт; h_{21}=70 \dots 300; f_T=10ГГц$	B	E	C
310	AT-31033	HP	NPN	$V_{CB0}=11B; I_C=16mA; P_D=150mBт; h_{21}=70 \dots 300; f_T=10ГГц$	B	E	C
320	AT-32033	HP	NPN	$V_{CB0}=11B; I_C=32mA; P_D=200mBт; h_{21}=70 \dots 300; f_T=10ГГц$	B	E	C
3A	BC856C	CDIL	PNP	$V_{CB0}=-80B; I_C=-100mA; P_D=310mBт; h_{21}=110 \dots 220; f_T>150MГц$	B	E	C
3A	BC856ALT1	MOT	PNP	$V_{CB0}=-80B; I_C=-100mA; P_D=300mBт; h_{21}=125 \dots 250; f_T>100MГц$	B	E	C
3A	KST24	SAMS	NPN	$V_{CB0}=40B; I_C=100mA; P_D=350mBт; h_{21}>30; f_T>620MГц$	B	E	C
3A	BC856A	TOSH	PNP	$V_{CB0}=-80B; I_C=-100mA; P_D=150mBт; h_{21}=125 \dots 250; f_T=300MГц$	B	E	C
3A	BC856A	VISH	PNP	$V_{CB0}=-80B; I_C=-100mA; P_D=310mBт; h_{21}=110 \dots 220; f_T>150MГц$	B	E	C
3A	BC856A	ZETEX	PNP	$V_{CB0}=-80B; I_C=-100mA; P_D=330mBт; h_{21}=125 \dots 250; f_T>150MГц$	B	E	C
3Ap	BC856A	PHIL	PNP	$V_{CB0}=-80B; I_C=-100mA; P_D=250mBт; h_{21}=125 \dots 250; f_T>100MГц$	B	E	C
3AR	BC856AR	PHIL	PNP	$V_{CB0}=-65B; I_C=-100mA; P_D=200mBт; h_{21}=125; f_T>150MГц$	E	B	C
3As	BC856A	SIEM	PNP	$V_{CB0}=-80B; I_C=-100mA; P_D=330mBт; h_{21}=125 \dots 250; f_T=250MГц$	B	E	C
3B	TMPT918	ALLEG	NPN	$V_{CB0}=30B; I_{CB0}<10HA; h_{21}>20; V_{CE(sat)}<0.4B; f_T>600MГц$	B	E	C
3B	BC856B	CDIL	PNP	$V_{CB0}=-80B; I_C=-100mA; P_D=310mBт; h_{21}=200 \dots 450; f_T>150MГц$	B	E	C
3B	BC856BLT1	MOT	PNP	$V_{CB0}=-80B; I_C=-100mA; P_D=300mBт; h_{21}=220 \dots 475; f_T>100MГц$	B	E	C
3B	BC856B	TOSH	PNP	$V_{CB0}=-80B; I_C=-100mA; P_D=150mBт; h_{21}=220 \dots 475; f_T=300MГц$	B	E	C
3B	BC856B	VISH	PNP	$V_{CB0}=-80B; I_C=-100mA; P_D=310mBт; h_{21}=200 \dots 450; f_T>150MГц$	B	E	C
3B	FMMT918	ZETEX	NPN	$V_{CB0}=30B; I_C=100mA; P_D=330mBт; h_{21}>20; f_T>600MГц$	B	E	C
3Bp	BC856B	PHIL	PNP	$V_{CB0}=-80B; I_C=-100mA; P_D=250mBт; h_{21}=220 \dots 475; f_T>100MГц$	B	E	C
3BR	BC856BR	PHIL	PNP	$V_{CB0}=-65B; I_C=-100mA; P_D=200mBт; h_{21}=475; f_T>100MГц$	E	B	C
3Bs	BC856B	SIEM	PNP	$V_{CB0}=-80B; I_C=-100mA; P_D=330mBт; h_{21}=220 \dots 475; f_T=250MГц$	B	E	C
3D	BC856	CDIL	PNP	$V_{CB0}=-80B; I_C=-100mA; P_D=250mBт; h_{21}=125 \dots 800; f_T>100MГц$	B	E	C
3D	MMBTH81LT1	MOT	PNP	$V_{CB0}=-20B; P_D=300mBт; h_{21}>60; f_T>600MГц$	B	E	C
3Dp	BC856	PHIL	PNP	$V_{CB0}=-80B; I_C=-100mA; P_D=250mBт; h_{21}=125 \dots 800; f_T>100MГц$	B	E	C
3E	BC857A	CDIL	PNP	$V_{CB0}=-50B; I_C=-100mA; P_D=310mBт; h_{21}=110 \dots 220; f_T>150MГц$	B	E	C
3E	BC857ALT1	MOT	PNP	$V_{CB0}=-50B; I_C=-100mA; P_D=300mBт; h_{21}=125 \dots 250; f_T>100MГц$	B	E	C
3E	KST10	SAMS	NPN	$V_{CB0}=30B; P_D=350mBт; h_{21}>60; f_T>650MГц$	B	E	C
3E	BC857A	TOSH	PNP	$V_{CB0}=-50B; I_C=-100mA; P_D=150mBт; h_{21}=125 \dots 250; f_T=300MГц$	B	E	C
3E	BC857A	VISH	PNP	$V_{CB0}=-50B; I_C=-100mA; P_D=310mBт; h_{21}=110 \dots 220; f_T>150MГц$	B	E	C
3E	FMMTA42	ZETEX	NPN	$V_{CB0}=300B; I_C=200mA; P_D=330mBт; h_{21}>40; f_T>50MГц$	B	E	C
3EM	MMBTH10LT1	MOT	NPN	$V_{CB0}=30B; P_D=300mBт; h_{21}>60; f_T>650MГц$	B	E	C
3Ep	BC857A	PHIL	PNP	$V_{CB0}=-50B; I_C=-100mA; P_D=250mBт; h_{21}=125 \dots 250; f_T>100MГц$	B	E	C

SOT23, SOD23 (продолжение)

Код	Типономинал	Фирма	Функция	Особенности	Цоколевка		
					1	2	3
3ER	BC857AR	PHIL	PNP	$V_{CB0}=-45B; I_C=-100mA; P_D=250mBт; h_{21}=220; f_T>150MГц$	E	B	C
3Es	BC857A	SIEM	PNP	$V_{CB0}=-50B; I_C=-100mA; P_D=330mBт; h_{21}=125...250; f_T=250MГц$	B	E	C
3EZ	FMMTA10	ZETEX	NPN	$V_{CB0}=30B; I_C=25mA; P_D=330mBт; h_{21}>60; f_T>650MГц$	B	E	C
3F	BC857B	CDIL	PNP	$V_{CB0}=-50B; I_C=-100mA; P_D=310mBт; h_{21}=200...450; f_T>150MГц$	B	E	C
3F	BC857BLT1	MOT	PNP	$V_{CB0}=-50B; I_C=-100mA; P_D=300mBт; h_{21}=220...475; f_T>100MГц$	B	E	C
3F	BC857B	TOSH	PNP	$V_{CB0}=-50B; I_C=-100mA; P_D=150mBт; h_{21}=220...475; f_T=300MГц$	B	E	C
3F	BC857B	VISH	PNP	$V_{CB0}=-50B; I_C=-100mA; P_D=310mBт; h_{21}=200...450; f_T>150MГц$	B	E	C
3F	BC857B	ZETEX	PNP	$V_{CB0}=-50B; I_C=-100mA; P_D=330mBт; h_{21}=220...475; f_T>150MГц$	B	E	C
3Fp	BC857B	PHIL	PNP	$V_{CB0}=-50B; I_C=-100mA; P_D=250mBт; h_{21}=220...475; f_T>100MГц$	B	E	C
3FR	BC857BR	PHIL	PNP	$V_{CB0}=-45B; I_C=-100mA; P_D=200mBт; h_{21}=475; f_T>150MГц$	E	B	C
3Fs	BC857B	SIEM	PNP	$V_{CB0}=-50B; I_C=-100mA; P_D=330mBт; h_{21}=220...475; f_T=250MГц$	B	E	C
3G	BC857C	CDIL	PNP	$V_{CB0}=-50B; I_C=-100mA; P_D=310mBт; h_{21}=420...800; f_T>150MГц$	B	E	C
3G	BC857C	TOSH	PNP	$V_{CB0}=-50B; I_C=-100mA; P_D=150mBт; h_{21}=420...800; f_T>300MГц$	B	E	C
3G	BC857C	VISH	PNP	$V_{CB0}=-50B; I_C=-100mA; P_D=310mBт; h_{21}=420...800; f_T>150MГц$	B	E	C
3G	BC857C	ZETEX	PNP	$V_{CB0}=-50B; I_C=-100mA; P_D=330mBт; h_{21}=420...800; f_T>150MГц$	B	E	C
3Gp	BC857C	PHIL	PNP	$V_{CB0}=-50B; I_C=-100mA; P_D=250mBт; h_{21}=420...800; f_T>100MГц$	B	E	C
3GR	BC857CR	PHIL	PNP	$V_{CB0}=-45B; I_C=-100mA; P_D=200mBт; h_{21}=800; f_T>150MГц$	E	B	C
3Gs	BC857C	SIEM	PNP	$V_{CB0}=-50B; I_C=-100mA; P_D=330mBт; h_{21}=420...800; f_T=250MГц$	B	E	C
3H	BC857	CDIL	PNP	$V_{CB0}=-50B; I_C=-100mA; P_D=250mBт; h_{21}=125...800; f_T>100MГц$	B	E	C
3Hp	BC857	PHIL	PNP	$V_{CB0}=-50B; I_C=-100mA; P_D=250mBт; h_{21}=125...800; f_T>100MГц$	B	E	C
3J	BC858A	CDIL	PNP	$V_{CB0}=-30B; I_C=-100mA; P_D=310mBт; h_{21}=110...220; f_T>150MГц$	B	E	C
3J	BC858ALT1	MOT	PNP	$V_{CB0}=-30B; I_C=-100mA; P_D=300mBт; h_{21}=125...250; f_T>100MГц$	B	E	C
3J	BC858A	VISH	PNP	$V_{CB0}=-30B; I_C=-100mA; P_D=310mBт; h_{21}=110...220; f_T>150MГц$	B	E	C
3J	BC858A	ZETEX	PNP	$V_{CB0}=-30B; I_C=-100mA; P_D=330mBт; h_{21}=125...250; f_T>150MГц$	B	E	C
3Jp	BC858A	PHIL	PNP	$V_{CB0}=-30B; I_C=-100mA; P_D=250mBт; h_{21}=125...250; f_T>100MГц$	B	E	C
3JR	BC858AR	PHIL	PNP	$V_{CB0}=-30B; I_C=-100mA; P_D=250mBт; h_{21}=220; f_T>150MГц$	E	B	C
3Js	BC858A	SIEM	PNP	$V_{CB0}=-30B; I_C=-100mA; P_D=330mBт; h_{21}=125...250; f_T=250MГц$	B	E	C
3K	BC858B	CDIL	PNP	$V_{CB0}=-30B; I_C=-100mA; P_D=310mBт; h_{21}=200...450; f_T>150MГц$	B	E	C
3K	BC858BLT1	MOT	PNP	$V_{CB0}=-30B; I_C=-100mA; P_D=300mBт; h_{21}=220...475; f_T>100MГц$	B	E	C
3K	BC858B	TOSH	PNP	$V_{CB0}=-30B; I_C=-100mA; P_D=150mBт; h_{21}=220...475; f_T=300MГц$	B	E	C
3K	BC858B	VISH	PNP	$V_{CB0}=-30B; I_C=-100mA; P_D=310mBт; h_{21}=200...450; f_T>150MГц$	B	E	C
3K	BC858B	ZETEX	PNP	$V_{CB0}=-30B; I_C=-100mA; P_D=330mBт; h_{21}=220...475; f_T>150MГц$	B	E	C
3Kp	BC858B	PHIL	PNP	$V_{CB0}=-30B; I_C=-100mA; P_D=250mBт; h_{21}=220...475; f_T>100MГц$	B	E	C
3KR	BC858BR	PHIL	PNP	$V_{CB0}=-30B; I_C=-100mA; P_D=200mBт; h_{21}=475; f_T>150MГц$	E	B	C
3Ks	BC858B	SIEM	PNP	$V_{CB0}=-30B; I_C=-100mA; P_D=330mBт; h_{21}=220...475; f_T=250MГц$	B	E	C
3L	BC858C	CDIL	PNP	$V_{CB0}=-30B; I_C=-100mA; P_D=310mBт; h_{21}=420...800; f_T>150MГц$	B	E	C
3L	BC858CLT1	MOT	PNP	$V_{CB0}=-30B; I_C=-100mA; P_D=300mBт; h_{21}=420...800; f_T>100MГц$	B	E	C
3L	BC858C	TOSH	PNP	$V_{CB0}=-30B; I_C=-100mA; P_D=150mBт; h_{21}=420...800; f_T=300MГц$	B	E	C
3L	BC858C	VISH	PNP	$V_{CB0}=-30B; I_C=-100mA; P_D=310mBт; h_{21}=420...800; f_T>150MГц$	B	E	C

SOT23, SOD23 (продолжение)

Код	Типономинал	Фирма	Функция	Особенности	Цоколевка		
					1	2	3
3L	BC858C	ZETEX	PNP	$V_{CB0}=-30B; I_C=-100_{MA}; P_D=330_{MBT}; h_{21}=420...800;$ $f_T>150_{MГц}$	B	E	C
3Lp	BC858C	PHIL	PNP	$V_{CB0}=-30B; I_C=-100_{MA}; P_D=250_{MBT}; h_{21}=420...800;$ $f_T>100_{MГц}$	B	E	C
3LR	BC858CR	PHIL	PNP	$V_{CB0}=-30B; I_C=-100_{MA}; P_D=250_{MBT}; h_{21}=800; f_T>150_{MГц}$	E	B	C
3Ls	BC858C	SIEM	PNP	$V_{CB0}=-30B; I_C=-100_{MA}; P_D=330_{MBT}; h_{21}=420...800;$ $f_T=250_{MГц}$	B	E	C
3M	BC858	CDIL	PNP	$V_{CB0}=-30B; I_C=-100_{MA}; P_D=250_{MBT}; h_{21}=125...800;$ $f_T>100_{MГц}$	B	E	C
3m	FMMT5087R	ZETEX	PNP	$V_{CB0}=-50B; I_C=-100_{MA}; P_D=330_{MBT}; h_{21}=200...600;$ $f_T>40_{MГц}$	B	E	C
3Mp	BC858	PHIL	PNP	$V_{CB0}=-30B; I_C=-100_{MA}; P_D=250_{MBT}; h_{21}=125...800;$ $f_T>100_{MГц}$	B	E	C
3C	FMMTA20R	ZETEX	NPN	$V_{CB0}=40B; I_C=100_{MA}; P_D=330_{MBT}; h_{21}=40...400;$ $f_T>125_{MГц}$	B	E	C
3N	MMBT3906	VISH	PNP	$V_{CB0}=-40B; I_C=-100_{MA}; P_D=200_{MBT}; h_{21}=100...300;$ $f_T>250_{MГц}$	B	E	C
3P	FMMT2222AR	ZETEX	NPN	$V_{CB0}=75B; I_C=600_{MA}; P_D=330_{MBT}; h_{21}=120...360;$ $f_T>300_{MГц}$	B	E	C
3S	MMBT5551	VISH	NPN	$V_{CB0}=180B; I_C=200_{MA}; P_D=350_{MBT}; h_{21}=80...250;$ $f_T>300_{MГц}$	B	E	C
3W	FMMTA12	ZETEX	NPN	$V_{CB0}=20B; I_C=300_{MA}; P_D=330_{MBT}; h_{21}>20000$	B	E	C
413	FMMT413	ZETEX	NPN	$V_{CB0}=150B; I_C=100_{MA}; P_D=330_{MBT}; h_{21}>50; f_T>150_{MГц}$	B	E	C
415	FMMT415	ZETEX	NPN	$V_{CB0}=260B; I_C=500_{MA}; P_D=330_{MBT}; h_{21}>25; f_T>40_{MГц}$	B	E	C
417	FMMT417	ZETEX	NPN	$V_{CB0}=320B; I_C=500_{MA}; P_D=330_{MBT}; h_{21}>25; f_T>40_{MГц}$	B	E	C
43	BAS40	VISH	SHD	$V_R<40B; I_F<200_{MA}; V_F(I_F=40_{MA})<1.0B; I_R<0.2_{мкА};$ $C_D<5.0_{пФ};$ $t_{RR}<5_{нс}$	A	nc	K
43p	BAS40	PHIL	SHD	$V_R<40B; I_F<120_{MA}; V_F(I_F=1_{MA})<380_{MB}; C_D<5_{пФ}$	A	nc	K
43s	BAS40	SIEM	SHD	$V_R<40B; I_F<120_{MA}; V_F(I_F=40_{MA})<1.0B; I_R<1.0_{мкА};$ $C_D<5.0_{пФ}$	A	nc	K
44	BAS40-04	VISH	2xSHD	$V_R<40B; I_F<200_{MA}; V_F(I_F=40_{MA})<1.0B; I_R<0.2_{мкА};$ $C_D<5.0_{пФ};$ $t_{RR}<5_{нс}$	A1	K2	K1 A2
449	FMMT449	ZETEX	NPN	$V_{CB0}=50B; I_C=1000_{MA}; P_D=500_{MBT}; h_{21}=100...300;$ $f_T>150_{MГц}$	B	E	C
44p	BAS40-04	PHIL	2xSHD	$V_R<40B; I_F<120_{MA}; V_F(I_F=1_{MA})<380_{MB}; C_D<5_{пФ}$	A1	K2	K1 A2
44s	BAS40-04	SIEM	2xSHD	$V_R<40B; I_F<120_{MA}; V_F(I_F=40_{MA})<1.0B; I_R<1.0_{мкА};$ $C_D<5.0_{пФ};$	A1	K2	K1 A2
45	BAS40-05	VISH	2xSHD	$V_R=40B; I_F=200_{MA}; P_D=200_{MBT}; t_{RR}<5_{нс}$	A1	A2	K1 K2
451	FMMT451	ZETEX	NPN	$V_{CB0}=80B; I_C=1000_{MA}; P_D=500_{MBT}; h_{21}=50...150;$ $f_T>150_{MГц}$	B	E	C
455	FMMT455	ZETEX	NPN	$V_{CB0}=160B; I_C=1000_{MA}; P_D=500_{MBT}; h_{21}=100...300;$ $f_T>100_{MГц}$	B	E	C
458	FMMT458	ZETEX	NPN	$V_{CB0}=400B; I_C=225_{MA}; P_D=500_{MBT}; h_{21}=100...300;$ $f_T>50_{MГц}$	B	E	C
459	FMMT459	ALLEG	DL	$I_F<500_{MA}; VBR>200B; V_F(I_F=3_{MA})1.0B; I_R<25_{HA};$ $C_0<6.0_{пФ};$	A	nc	K
45p	BAS40-05	PHIL	2xSHD	$V_R<40B; I_F<120_{MA}; V_F(I_F=1_{MA})<380_{MB}; C_D<5_{пФ};$	A1	A2	K1 K2
45s	BAS40-05	SIEM	2xSHD	$V_R<40B; I_F<120_{MA}; V_F(I_F=40_{MA})<1.0B; I_R<1.0_{мкА};$ $C_D<5.0_{пФ};$	A1	K2	K1 A2
46	BAS40-06	VISH	2xSHD	$V_R<40B; I_F<200_{MA}; V_F(I_F=40_{MA})<1.0B; I_R<0.2_{мкА};$ $C_D<5.0_{пФ};$ $t_{RR}<5_{нс}$	K1	K2	A1 A2
46p	BAS40-06	PHIL	2xSHD	$V_R<40B; I_F<120_{MA}; V_F(I_F=1_{MA})<380_{MB}; C_D<5_{пФ};$	K1	K2	A1 A2
46s	BAS40-06	SIEM	2xSHD	$V_R<40B; I_F<120_{MA}; V_F(I_F=40_{MA})<1.0B; I_R<1.0_{мкА};$ $C_D<5.0_{пФ};$	K1	K2	A1 A2
489	FMMT489	ZETEX	NPN	$V_{CB0}=50B; I_C=1000_{MA}; P_D=500_{MBT}; h_{21}=100...300;$ $f_T>150_{MГц}$	B	E	C
491	FMMT491	ZETEX	NPN	$V_{CB0}=80B; I_C=1000_{MA}; P_D=500_{MBT}; h_{21}=100...300;$ $f_T>150_{MГц}$	B	E	C
493	FMMT493	ZETEX	NPN	$V_{CB0}=120B; I_C=1000_{MA}; P_D=500_{MBT}; h_{21}=100...300;$ $f_T>150_{MГц}$	B	E	C

SOT23, SOD23 (продолжение)

Код	Типономинал	Фирма	Функция	Особенности	Цоколевка		
					1	2	3
494	FMMT494	ZETEX	NPN	$V_{CB0}=140B; I_C=1000_{MA}; P_D=500_{MBT}; h_{21}=100...300; f_T>100_{MGU}$	B	E	C
495	FMMT495	ZETEX	NPN	$V_{CB0}=170B; I_C=1000_{MA}; P_D=500_{MBT}; h_{21}=100...300; f_T>100_{MGU}$	B	E	C
497	FMMT497	ZETEX	NPN	$V_{CB0}=300B; I_C=500_{MA}; P_D=500_{MBT}; h_{21}=80...300; f_T>75_{MGU}$	B	E	C
4A	BC859A	CDIL	PNP	$V_{CB0}=-30B; I_C=-100_{MA}; P_D=310_{MBT}; h_{21}=110...220; f_T>150_{MGU}$	B	E	C
4A	FMMT458	ZETEX	BD	$V_R<30B; C_{3V}=26...32 \text{ пФ}; C_{3V}/C_{25V}=5...6.5; Q>250$	A	nc	K
4Ap	BC859A	PHIL	PNP	$V_{CB0}=-30B; I_C=-100_{MA}; P_D=250_{MBT}; h_{21}=125...250; f_T>100_{MGU}$	B	E	C
4AR	BC859AR	PHIL	PNP	$V_{CB0}=-30B; I_C=-100_{MA}; P_D=200_{MBT}; h_{21}=250; f_T>150_{MGU}$	E	B	C
4As	BC859C	SIEM	PNP	$V_{CB0}=-30B; I_C=-100_{MA}; P_D=330_{MBT}; h_{21}=125...250; f_T=250_{MGU}$	B	E	C
4B	BC859B	CDIL	PNP	$V_{CB0}=-30B; I_C=-100_{MA}; P_D=330_{MBT}; h_{21}=220...475; f_T>300_{MGU}$	B	E	C
4B	BC859B	TOSH	PNP	$V_{CB0}=-30B; I_C=-100_{MA}; P_D=150_{MBT}; h_{21}=220...475; f_T=300_{MGU}$	B	E	C
4B	BC859B	ZETEX	PNP	$V_{CB0}=-30B; I_C=-100_{MA}; P_D=330_{MBT}; h_{21}=220...475; f_T>300_{MGU}$	B	E	C
4Bp	BC859B	PHIL	PNP	$V_{CB0}=-30B; I_C=-100_{MA}; P_D=250_{MBT}; h_{21}=220...475; f_T>100_{MGU}$	E	B	C
4BR	BC859BR	PHIL	PNP	$V_{CB0}=-30B; I_C=-100_{MA}; P_D=200_{MBT}; h_{21}=475; f_T>150_{MGU}$	B	E	C
4Bs	BC859B	SIEM	PNP	$V_{CB0}=-30B; I_C=-100_{MA}; P_D=330_{MBT}; h_{21}=220...475; f_T=250_{MGU}$	B	E	C
4C	BC859C	CDIL	PNP	$V_{CB0}=-30B; I_C=-100_{MA}; P_D=330_{MBT}; h_{21}=420...800; f_T>250_{MGU}$	B	E	C
4C	BC859C	TOSH	PNP	$V_{CB0}=-30B; I_C=-100_{MA}; P_D=150_{MBT}; h_{21}=420...800; f_T=300_{MGU}$	B	E	C
4C	BC859C	ZETEX	PNP	$V_R<30B; C_{3V}=20...25 \text{ пФ}; C_{3V}/C_{25V}>4.5; Q>300$	A	nc	K
4Cp	BC859C	PHIL	PNP	$V_{CB0}=-30B; I_C=-100_{MA}; P_D=250_{MBT}; h_{21}=420...800; f_T>100_{MGU}$	B	E	C
4CR	BC859CR	PHIL	PNP	$V_{CB0}=-30B; I_C=-100_{MA}; P_D=200_{MBT}; h_{21}=800; f_T>150_{MGU}$	E	B	C
4Cs	BC859C	SIEM	PNP	$V_{CB0}=-30B; I_C=-100_{MA}; P_D=330_{MBT}; h_{21}=420...800; f_T=250_{MGU}$	B	E	C
4D	BC859	CDIL	PNP	$V_{CB0}=-30B; I_C=-100_{MA}; P_D=250_{MBT}; h_{21}=125...800; f_T>100_{MGU}$	B	E	C
4D	HD3A	ZETEX	FID	$V_R<75B; I_F<100_{MA}; V_F(I_F=10_{MA})<1.0B; I_R<1.0_{mkA}; C_D<4.0 \text{ пФ}; t_{RR}<6_{HC}$	A	nc	K
4Dp	BC859	PHIL	PNP	$V_{CB0}=-30B; I_C=-100_{MA}; P_D=250_{MBT}; h_{21}=125...800; f_T>100_{MGU}$	B	E	C
4E	BC860A	CDIL	PNP	$V_{CB0}=-50B; I_C=-100_{MA}; P_D=250_{MBT}; h_{21}=125...800; f_T>100_{MGU}$	B	E	C
4E	FMMTA92	ZETEX	PNP	$V_{CB0}=-300B; I_C=-200_{MA}; P_D=330_{MBT}; h_{21}>25; f_T>50_{MGU}$	B	E	C
4Ep	BC860A	PHIL	PNP	$V_{CB0}=-50B; I_C=-100_{MA}; P_D=250_{MBT}; h_{21}=125...250; f_T>100_{MGU}$	B	E	C
4ER	BC860AR	PHIL	PNP	$V_{CB0}=-45B; I_C=-100_{MA}; P_D=200_{MBT}; h_{21}=250; f_T>150_{MGU}$	E	B	C
4EZ	FMMTV105G	ZETEX	BD	$V_R<30B; C_{3V}=1.8...2.8 \text{ пФ}; C_{3V}/C_{25V}=4...6; Q>350$	A	nc	K
4F	BC860B	CDIL	PNP	$V_{CB0}=-50B; I_C=-100_{MA}; P_D=330_{MBT}; h_{21}=220...475; f_T>300_{MGU}$	B	E	C
4F	BC860B	ZETEX	PNP	$V_{CB0}=-50B; I_C=-100_{MA}; P_D=330_{MBT}; h_{21}=220...475; f_T>300_{MGU}$	B	E	C
4Fp	BC860B	PHIL	PNP	$V_{CB0}=-50B; I_C=-100_{MA}; P_D=250_{MBT}; h_{21}=220...475; f_T>100_{MGU}$	B	E	C
4FR	BC860BR	PHIL	PNP	$V_{CB0}=-45B; I_C=-100_{MA}; P_D=200_{MBT}; h_{21}=475; f_T>150_{MGU}$	E	B	C
4Fs	BC860B	SIEM	PNP	$V_{CB0}=-50B; I_C=-100_{MA}; P_D=330_{MBT}; h_{21}=220...475; f_T=250_{MGU}$	B	E	C
4G	BC860C	CDIL	PNP	$V_{CB0}=-50B; I_C=-100_{MA}; P_D=250_{MBT}; h_{21}=420...800; f_T>100_{MGU}$	B	E	C
4G	FMMT2484	ZETEX	NPN	$V_{CB0}=60B; I_C=50_{MA}; P_D=330_{MBT}; h_{21}=100...500$	B	E	C
4Gp	BC860C	PHIL	PNP	$V_{CB0}=-50B; I_C=-100_{MA}; P_D=250_{MBT}; h_{21}=420...800; f_T>100_{MGU}$	B	E	C
4GR	BC860CR	PHIL	PNP	$V_{CB0}=-45B; I_C=-100_{MA}; P_D=200_{MBT}; h_{21}=800; f_T>150_{MGU}$	E	B	C
4Gs	BC860C	SIEM	PNP	$V_{CB0}=-50B; I_C=-100_{MA}; P_D=330_{MBT}; h_{21}=420...800; f_T=250_{MGU}$	B	E	C
4GZ	BC860C	ZETEX	PNP	$V_{CB0}=-50B; I_C=-100_{MA}; P_D=330_{MBT}; h_{21}=420...800; f_T>300_{MGU}$	B	E	C
4H	BC860	CDIL	PNP	$V_{CB0}=-50B; I_C=-100_{MA}; P_D=250_{MBT}; h_{21}=125...800; f_T>100_{MGU}$	B	E	C
4Hp	BC860	PHIL	PNP	$V_{CB0}=-50B; I_C=-100_{MA}; P_D=250_{MBT}; h_{21}=125...800; f_T>100_{MGU}$	B	E	C

SOT23, SOD23 (продолжение)

Код	Типономинал	Фирма	Функция	Особенности	Цоколевка		
					1	2	3
4J	FMMT38A	ZETEX	NPN	$V_{CB0}=-80B; I_C=300_{MA}; P_D=330_{mBT}; h_{21}>500$	B	E	C
4P	FMMT2907R	ZETEX	PNP	$V_{CB0}=-60B; I_C=-600_{MA}; P_D=330_{mBT}; h_{21}=100...300; f_T>200_{MГц}$	B	E	C
4V	BCW65AR	ZETEX	NPN	$V_{CB0}=60B; I_C=800_{MA}; P_D=330_{mBT}; h_{21}=100...250; f_T>100_{MГц}$	B	E	C
4W	BCW67AR	ZETEX	PNP	$V_{CB0}=-45B; I_C=-800_{MA}; P_D=330_{mBT}; h_{21}=100...250; f_T>100_{MГц}$	B	E	C
517	FMMT6517	ZETEX	NPN	$V_{CB0}=350B; I_C=500_{MA}; P_D=330_{mBT}; h_{21}=30...200; f_T>50_{MГц}$	B	E	C
520	FMMT6520	ZETEX	PNP	$V_{CB0}=-350B; I_C=-500_{MA}; P_D=330_{mBT}; h_{21}=30...200; f_T>50_{MГц}$	B	E	C
53	BAT17	SIEM	SHD	$V_R<4B; I_F<130_{MA}; V_F(I_F=10_{MA})<0.6B; I_R<0.25_{мкA}; C_D<1_{пФ};$	A	nc	K
54	BAT17-04	SIEM	2xSHD	$V_R<4B; I_F<130_{MA}; V_F(I_F=10_{MA})<0.6B; I_R<0.25_{мкA}; C_D<1_{пФ};$	A1	K2	K1 A2
549	FMMT549	ZETEX	PNP	$V_{CB0}=-35B; I_C=-100_{MA}; P_D=500_{mBT}; h_{21}=100...300; f_T>100_{MГц}$	B	E	C
55	BAT17-05	SIEM	2xSHD	$V_R<4B; I_F<130_{MA}; V_F(I_F=10_{MA})<0.6B; I_R<0.25_{мкA}; C_D<1_{пФ};$	A1	K2	K1 A2
551	FMMT551	ZETEX	PNP	$V_{CB0}=-80B; I_C=-1000_{MA}; P_D=500_{mBT}; h_{21}=50...150; f_T>150_{MГц}$	B	E	C
555	FMMT555	ZETEX	PNP	$V_{CB0}=-160B; I_C=-1000_{MA}; P_D=500_{mBT}; h_{21}=50...300; f_T>100_{MГц}$	B	E	C
558	FMMT558	ZETEX	PNP	$V_{CB0}=-400; I_C=-150_{MA}; P_D=500_{mBT}; h_{21}=100...300; f_T>50_{MГц}$	B	E	C
56	BAT17-06	SIEM	2xSHD	$V_R<4B; I_F<130_{MA}; V_F(I_F=10_{MA})<0.6B; I_R<0.25_{мкA}; C_D<1_{пФ};$	K1	K2	A1 A2
576	FMMT576	ZETEX	PNP	$V_{CB0}=-200B; I_C=-1000_{MA}; P_D=500_{mBT}; h_{21}=50...300; f_T>100_{MГц}$	B	E	C
589	FMMT589	ZETEX	PNP	$V_{CB0}=-50B; I_C=-1000_{MA}; P_D=500_{mBT}; h_{21}=100...300; f_T>10_{MГц}$	B	E	C
591	FMMT591	ZETEX	PNP	$V_{CB0}=-80B; I_C=-1000_{MA}; P_D=500_{mBT}; h_{21}=100...300; f_T>150_{MГц}$	B	E	C
593	FMMT593	ZETEX	PNP	$V_{CB0}=-120B; I_C=-1000_{MA}; P_D=500_{mBT}; h_{21}=100...300; f_T>50_{MГц}$	B	E	C
596	FMMT596	ZETEX	PNP	$V_{CB0}=-220B; I_C=-300_{MA}; P_D=500_{mBT}; h_{21}=85...300; f_T>150_{MГц}$	B	E	C
597	FMMT597	ZETEX	PNP	$V_{CB0}=-300B; I_C=-200_{MA}; P_D=500_{mBT}; h_{21}=100...300; f_T>75_{MГц}$	B	E	C
59A	FMMT549A	ZETEX	PNP	$V_{CB0}=-35B; I_C=-100_{MA}; P_D=500_{mBT}; h_{21}=150...500; f_T>100_{MГц}$	B	E	C
5A	BC807-16	CDIL	PNP	$V_{CB0}=-45B; I_C=-500_{MA}; P_D=250_{mBT}; h_{21}=100...250; f_T>80_{MГц}$	B	E	C
5A	BC807-16LT1	MOT	PNP	$V_{CB0}=-50B; I_C=-500_{MA}; P_D=300_{mBT}; h_{21}=100...250; f_T>200_{MГц}$	B	E	C
5A	FMMD5060	ZETEX	FID	$V_R<70B; I_F<200_{MA}; V_F(I_F=100_{MA})<1.1B; I_R<0.1_{мкA}; C_D<2.5_{пФ}; T_{RR}<5_{нс}$	A	nc	K
5Ap	BC807-16	PHIL	PNP	$V_{CB0}=-45B; I_C=-500_{MA}; P_D=250_{mBT}; h_{21}=100...250; f_T>80_{MГц}$	B	E	C
5AR	BC807-16R	PHIL	PNP	$V_{CB0}=-50B; I_C=-500_{MA}; P_D=250_{mBT}; h_{21}>250; f_T>100_{MГц}$	E	B	C
5As	BC807-16	SIEM	PNP	$V_{CB0}=-50B; I_C=-500_{MA}; P_D=330_{mBT}; h_{21}=100...250; f_T>200_{MГц}$	B	E	C
5AZ	BC807-16	ZETEX	PNP	$V_{CB0}=-50B; I_C=-500_{MA}; P_D=330_{mBT}; h_{21}=100...250; f_T>100_{MГц}$	B	E	C
5B	BC807-25	CDIL	PNP	$V_{CB0}=-45B; I_C=-500_{MA}; P_D=250_{mBT}; h_{21}=160...400; f_T>80_{MГц}$	B	E	C
5B	BC807-25LT1	MOT	PNP	$V_{CB0}=-50B; I_C=-500_{MA}; P_D=300_{mBT}; h_{21}=160...400; f_T>200_{MГц}$	B	E	C
5B	KST4123	SAMS	NPN	$V_{CB0}=40B; I_C=200_{MA}; P_D=350_{mBT}; h_{21}=50...150; f_T>250_{MГц}$	B	E	C
5B	FMMD6100	ZETEX	2xFID	$V_R<70B; I_F<200_{MA}; V_F(I_F=100_{MA})<1.1B; I_R<0.1_{мкA}; C_D<2.5_{пФ}; t_{RR}<5_{нс}$	A1	A2	K1 K2
5Bp	BC807-25	PHIL	PNP	$V_{CB0}=-45B; I_C=-500_{MA}; P_D=250_{mBT}; h_{21}=160...400; f_T>80_{MГц}$	B	E	C
5Bs	BC807-25	SIEM	PNP	$V_{CB0}=-50B; I_C=-500_{MA}; P_D=330_{mBT}; h_{21}=160...400; f_T=200_{MГц}$	B	E	C
5BZ	BC807-25	ZETEX	PNP	$V_{CB0}=-50B; I_C=-500_{MA}; P_D=330_{mBT}; h_{21}=160...400; f_T>100_{MГц}$	B	E	C
5C	BC807-40	CDIL	PNP	$V_{CB0}=-50B; I_C=-500_{MA}; P_D=330_{mBT}; h_{21}=250...630; f_T>200_{MГц}$	B	E	C
5C	BC807-40LT1	MOT	PNP	$V_{CB0}=-50B; I_C=-500_{MA}; P_D=300_{mBT}; h_{21}=250...600; f_T>200_{MГц}$	B	E	C

SOT23, SOD23 (продолжение)

Код	Типономинал	Фирма	Функция	Особенности	Цоколевка		
					1	2	3
5C	FMMD7000	ZETEX	2xFID	$V_R < 70B$; $I_F < 200_{MA}$; $V_F(I_F = 100_{MA}) < 1.1B$; $I_R < 0.3_{мкA}$; $C_D < 2.5_{пФ}$; $t_{RR} < 15_{нс}$	A1	K2	K1 A2
5Cp	BC807-40	PHIL	PNP	$V_{CB0} = -45B$; $I_C = -500_{MA}$; $P_D = 250_{мВт}$; $h_{21} = 250 \dots 600$; $f_T > 80_{МГц}$	B	E	C
5CR	BC807-40R	PHIL	PNP	$V_{CB0} = -50B$; $I_C = -500_{MA}$; $P_D = 310_{мВт}$; $h_{21} > 600$; $f_T > 100_{МГц}$	E	B	C
5Cs	BC807-40	SIEM	PNP	$V_{CB0} = -50B$; $I_C = -500_{MA}$; $P_D = 330_{мВт}$; $h_{21} = 250 \dots 630$; $f_T = 200_{МГц}$	B	E	C
5CZ	BC807-40	ZETEX	PNP	$V_{CB0} = -50B$; $I_C = -500_{MA}$; $P_D = 330_{мВт}$; $h_{21} = 250 \dots 600$; $f_T > 100_{МГц}$	B	E	C
5D	TMPD4148	ALLEG	D	$I_F < 600_{MA}$; $V_{BR} > 100B$; $V_F(I_F = 10_{MA}) < 1.0B$; $I_R < 25_{нA}$; $t_{RR} < 4.0_{нс}$; $C_D < 4.0_{пФ}$	A	nc	K
5D	TMPD914	ALLEG	D	$I_F < 600_{MA}$; $V_{BR} > 100B$; $V_F(I_F = 10_{MA}) < 1.0B$; $I_R < 25_{нA}$; $t_{RR} < 4.0_{нс}$; $C_D < 6.0_{пФ}$	A	nc	K
5D	BC807	CDIL	PNP	$V_{CB0} = -45B$; $I_C = -500_{MA}$; $P_D = 250_{мВт}$; $h_{21} = 100 \dots 600$; $f_T > 80_{МГц}$	B	E	C
5D	HD2A	ZETEX	2xFID	$V_R < 35B$; $I_F < 100_{MA}$; $V_F(I_F = 10_{MA}) < 1.0B$; $I_R < 1.0_{мкA}$; $C_D < 4.0_{пФ}$; $t_{RR} < 6_{нс}$	A1	A2	K1 K2
5D	FMMD914	ZETEX	FID	$V_R < 75B$; $I_F < 225_{MA}$; $V_F(I_F = 10_{MA}) < 1.0B$; $I_R < 0.025_{мкA}$; $C_D < 4.0_{пФ}$; $t_{RR} < 8_{нс}$	A	nc	K
5Dp	BC807	PHIL	PNP	$V_{CB0} = -45B$; $I_C = -500_{MA}$; $P_D = 250_{мВт}$; $h_{21} = 100 \dots 600$; $f_T > 80_{МГц}$	B	E	C
5DZ	BC807	ZETEX	PNP	$V_{CB0} = -50B$; $I_C = -500_{MA}$; $P_D = 330_{мВт}$; $h_{21} = 100 \dots 600$; $f_T = 100_{МГц}$	B	E	C
5E	BC808-16	CDIL	PNP	$V_{CB0} = -30B$; $I_C = -500_{MA}$; $P_D = 330_{мВт}$; $h_{21} = 100 \dots 250$; $f_T > 100_{МГц}$	B	E	C
5E	FMMTA43R	ZETEX	NPN	$V_{CB0} = 200B$; $I_C = 200_{MA}$; $P_D = 330_{мВт}$; $h_{21} = 50 \dots 200$; $f_T > 50_{МГц}$	B	E	C
5Ep	BC808-16	PHIL	PNP	$V_{CB0} = -25B$; $I_C = -500_{MA}$; $P_D = 250_{мВт}$; $h_{21} = 100 \dots 250$; $f_T > 80_{МГц}$	B	E	C
5ER	BC808-16R	PHIL	PNP	$V_{CB0} = -30B$; $I_C = -500_{MA}$; $P_D = 310_{мВт}$; $h_{21} > 250$; $f_T > 100_{МГц}$	E	B	C
5Es	BC808-16	SIEM	PNP	$V_{CB0} = -30B$; $I_C = -500_{MA}$; $P_D = 330_{мВт}$; $h_{21} = 100 \dots 250$; $f_T = 200_{МГц}$	B	E	C
5EZ	BC808-16	ZETEX	PNP	$V_{CB0} = -30B$; $I_C = -500_{MA}$; $P_D = 330_{мВт}$; $h_{21} = 100 \dots 250$; $f_T > 100_{МГц}$	B	E	C
5F	BC808-25	CDIL	PNP	$V_{CB0} = -30B$; $I_C = -500_{MA}$; $P_D = 330_{мВт}$; $h_{21} = 160 \dots 400$; $f_T > 200_{МГц}$	B	E	C
5Fp	BC808-25	PHIL	PNP	$V_{CB0} = -25B$; $I_C = -500_{MA}$; $P_D = 250_{мВт}$; $h_{21} = 160 \dots 400$; $f_T > 80_{МГц}$	B	E	C
5FR	BC808-25R	PHIL	PNP	$V_{CB0} = -30B$; $I_C = -500_{MA}$; $P_D = 310_{мВт}$; $h_{21} > 400$; $f_T > 100_{МГц}$	E	B	C
5Fs	BC808-25	SIEM	PNP	$V_{CB0} = -30B$; $I_C = -500_{MA}$; $P_D = 330_{мВт}$; $h_{21} = 160 \dots 400$; $f_T = 200_{МГц}$	B	E	C
5FZ	BC808-25	ZETEX	PNP	$V_{CB0} = -30B$; $I_C = -500_{MA}$; $P_D = 330_{мВт}$; $h_{21} = 160 \dots 400$; $f_T > 100_{МГц}$	B	E	C
5G	BC808-40	CDIL	PNP	$V_{CB0} = -30B$; $I_C = -500_{MA}$; $P_D = 330_{мВт}$; $h_{21} = 250 \dots 630$; $f_T > 200_{МГц}$	B	E	C
5Gp	BC808-40	PHIL	PNP	$V_{CB0} = -25B$; $I_C = -500_{MA}$; $P_D = 250_{мВт}$; $h_{21} = 250 \dots 600$; $f_T > 80_{МГц}$	B	E	C
5GR	BC808-40R	PHIL	PNP	$V_{CB0} = -30B$; $I_C = -500_{MA}$; $P_D = 310_{мВт}$; $h_{21} > 100$; $f_T > 100_{МГц}$	E	B	C
5Gs	BC808-40	SIEM	PNP	$V_{CB0} = -30B$; $I_C = -500_{MA}$; $P_D = 330_{мВт}$; $h_{21} = 250 \dots 630$; $f_T = 200_{МГц}$	B	E	C
5GZ	BC808-40	ZETEX	PNP	$V_{CB0} = -30B$; $I_C = -500_{MA}$; $P_D = 330_{мВт}$; $h_{21} = 250 \dots 600$; $f_T > 100_{МГц}$	B	E	C
5H	BC808	CDIL	PNP	$V_{CB0} = -25B$; $I_C = -500_{MA}$; $P_D = 250_{мВт}$; $h_{21} = 100 \dots 600$; $f_T > 80_{МГц}$	B	E	C
5H	MMBD4148	VISH	DI	$V_R < 75B$; $I_F < 300_{MA}$; $V_F(I_F = 10_{MA}) < 1.0B$; $I_R < 5.0_{мкA}$; $C_D < 4_{пФ}$; $t_{RR} < 6_{нс}$	A	nc	K
5Hp	BC808	PHIL	PNP	$V_{CB0} = -25B$; $I_C = -500_{MA}$; $P_D = 250_{мВт}$; $h_{21} = 100 \dots 600$; $f_T > 80_{МГц}$	B	E	C
5HZ	BC808	ZETEX	PNP	$V_{CB0} = -30B$; $I_C = -500_{MA}$; $P_D = 330_{мВт}$; $h_{21} = 100 \dots 600$; $f_T > 100_{МГц}$	B	E	C
5J	FMMT38B	ZETEX	NPN	$V_{CB0} = 80B$; $I_C = 300_{MA}$; $P_D = 330_{мВт}$; $h_{21} > 2000$	B	E	C
5P	FMMT2907AR	ZETEX	PNP	$V_{CB0} = -60B$; $I_C = -600_{MA}$; $P_D = 330_{мВт}$; $h_{21} = 100 \dots 300$; $f_T > 200_{МГц}$	B	E	C
5T	BCW66GR	ZETEX	NPN	$V_{CB0} = -75B$; $I_C = -800_{MA}$; $P_D = 330_{мВт}$; $h_{21} = 160 \dots 400$; $f_T > 100_{МГц}$	B	E	C
5T	BCW68GR	ZETEX	PNP	$V_{CB0} = -60B$; $I_C = -800_{MA}$; $P_D = 330_{мВт}$; $h_{21} = 160 \dots 400$; $f_T > 100_{МГц}$	B	E	C
5V	BCW65BR	ZETEX	NPN	$V_{CB0} = -60B$; $I_C = -800_{MA}$; $P_D = 330_{мВт}$; $h_{21} = 160 \dots 400$; $f_T > 100_{МГц}$	B	E	C
5W	BCW67BR	ZETEX	PNP	$V_{CB0} = -45B$; $I_C = -800_{MA}$; $P_D = 330_{мВт}$; $h_{21} = 160 \dots 400$; $f_T > 100_{МГц}$	B	E	C
614	FMMT614	ZETEX	NPN	$V_{CB0} = 120B$; $I_C = 500_{MA}$; $P_D = 500_{мВт}$; $h_{21} > 15000$	B	E	C

SOT23, SOD23 (продолжение)

Код	Типономинал	Фирма	Функция	Особенности	Цоколевка		
					1	2	3
617	FMMT617	ZETEX	NPN	$V_{CB0}=15B; I_C=3000_{MA}; P_D=625_{MBT}$	B	E	C
618	FMMT618	ZETEX	NPN	$V_{CB0}=-20B; I_C=-2500_{MA}; P_D=625_{MBT}; h_{21}=300...450; f_T>140_{MГц}$	B	E	C
619	FMMT619	ZETEX	NPN	$V_{CB0}=-50B; I_C=-2000_{MA}; P_D=625_{MBT}; h_{21}=300...450; f_T>160_{MГц}$	B	E	C
624	FMMT624	ZETEX	NPN	$V_{CB0}=-125B; I_C=-1000_{MA}; P_D=625_{MBT}; h_{21}=300...450; f_T>155_{MГц}$	B	E	C
625	FMMT625	ZETEX	NPN	$V_{CB0}=-150B; I_C=-1000_{MA}; P_D=625_{MBT}; h_{21}=300...450; f_T>135_{MГц}$	B	E	C
63s	BAT64	SIEM	SHD	$V_R<30B; I_F<250_{MA}; V_F(I_F=100_{MA})<0.75B; I_R<2_{мкА}; C_D<6_{пФ}$	A	nc	K
64s	BAT64-04	SIEM	2xSHD	$V_R<30B; I_F<250_{MA}; V_F(I_F=100_{MA})<0.75B; I_R<2.0_{мкА}; C_D<6_{пФ}$	A1	K2	K1 A2
65s	BAT64-05	SIEM	2xSHD	$V_R<30B; I_F<250_{MA}; V_F(I_F=100_{MA})<0.75B; I_R<2.0_{мкА}; C_D<6_{пФ}$	A1	A2	K1 K2
66s	BAT64-06	SIEM	2xSHD	$V_R<30B; I_F<250_{MA}; V_F(I_F=100_{MA})<0.75B; I_R<2.0_{мкА}; C_D<6_{пФ}$	K1	K2	A1 A2
6A	BC817-16	CDIL	NPN	$V_{CB0}=50B; I_C=500_{MA}; P_D=330_{MBT}; h_{21}=100...250; f_T>170_{MГц}$	B	E	C
6A	BC817-16LT1	MOT	NPN	$V_{CB0}=50B; I_C=500_{MA}; P_D=300_{MBT}; h_{21}=100...250; f_T>200_{MГц}$	B	E	C
6A	BC817-16	VISH	NPN	$V_{CB0}=50B; I_C=800_{MA}; P_D=310_{MBT}; h_{21}=100...250; f_T>100_{MГц}$	B	E	C
6Ap	BC817-16	PHIL	NPN	$V_{CB0}=45B; I_C=500_{MA}; P_D=250_{MBT}; h_{21}=100...250; f_T>80_{MГц}$	B	E	C
6AR	BC817-16R	PHIL	NPN	$V_{CB0}=45B; I_C=500_{MA}; P_D=310_{MBT}; h_{21}>250; f_T>200_{MГц}$	E	B	C
6As	BC817-16	SIEM	NPN	$V_{CB0}=50B; I_C=500_{MA}; P_D=330_{MBT}; h_{21}=100...250; f_T=170_{MГц}$	B	E	C
6AZ	BC817-16	ZETEX	NPN	$V_{CB0}=50B; I_C=500_{MA}; P_D=300_{MBT}; h_{21}=100...250; f_T=200_{MГц}$	B	E	C
6B	BC817-25	CDIL	NPN	$V_{CB0}=45B; I_C=500_{MA}; P_D=250_{MBT}; h_{21}=160...400; f_T>80_{MГц}$	B	E	C
6B	BC817-25LT1	MOT	NPN	$V_{CB0}=50B; I_C=500_{MA}; P_D=300_{MBT}; h_{21}=160...400; f_T>200_{MГц}$	B	E	C
6B	BC817-25	VISH	NPN	$V_{CB0}=50B; I_C=800_{MA}; P_D=310_{MBT}; h_{21}=160...400; f_T>100_{MГц}$	B	E	C
6BG	CMPF4416A	CENTS	nFET	$V_{GS}>35B; I_{DSS}=5...15_{MA}; V_{GS(off)}=2.5...6B; N_F=2/16;$	D	G	S
6Bp	BC817-25	PHIL	NPN	$V_{CB0}=45B; I_C=500_{MA}; P_D=250_{MBT}; h_{21}=160...400; f_T>80_{MГц}$	B	E	C
6BR	BC817-25R	PHIL	NPN	$V_{CB0}=45B; I_C=500_{MA}; P_D=310_{MBT}; h_{21}>400; f_T>200_{MГц}$	E	B	C
6Bs	BC817-25	SIEM	NPN	$V_{CB0}=50B; I_C=500_{MA}; P_D=330_{MBT}; h_{21}=160...400; f_T=170_{MГц}$	B	E	C
6BZ	BC817-25	ZETEX	NPN	$V_{CB0}=50B; I_C=500_{MA}; P_D=330_{MBT}; h_{21}=160...400; f_T=200_{MГц}$	B	E	C
6C	BC817-40	CDIL	NPN	$V_{CB0}=50B; I_C=500_{MA}; P_D=330_{MBT}; h_{21}=250...630; f_T>170_{MГц}$	B	E	C
6C	BC817-40LT1	MOT	NPN	$V_{CB0}=50B; I_C=500_{MA}; P_D=300_{MBT}; h_{21}=250...600; f_T>200_{MГц}$	B	E	C
6C	BC817-40	VISH	NPN	$V_{CB0}=50B; I_C=800_{MA}; P_D=310_{MBT}; h_{21}=250...630; f_T>100_{MГц}$	B	E	C
6Cp	BC817-40	PHIL	NPN	$V_{CB0}=45B; I_C=500_{MA}; P_D=250_{MBT}; h_{21}=250...600; f_T>80_{MГц}$	B	E	C
6CR	BC817-40R	PHIL	NPN	$V_{CB0}=45B; I_C=500_{MA}; P_D=310_{MBT}; h_{21}>600; f_T>200_{MГц}$	E	B	C
6Cs	BC817-40	SIEM	NPN	$V_{CB0}=50B; I_C=500_{MA}; P_D=330_{MBT}; h_{21}=250...630; f_T=170_{MГц}$	B	E	C
6CZ	BC817-40	ZETEX	NPN	$V_{CB0}=50B; I_C=500_{MA}; P_D=330_{MBT}; h_{21}=250...600; f_T=200_{MГц}$	B	E	C
6D	BC817	CDIL	NPN	$V_{CB0}=50B; I_C=500_{MA}; P_D=330_{MBT}; h_{21}=100...600; f_T>200_{MГц}$	B	E	C
6Dp	BC817	PHIL	NPN	$V_{CB0}=45B; I_C=500_{MA}; P_D=250_{MBT}; h_{21}=100...600; f_T>80_{MГц}$	B	E	C
6DZ	BC817	ZETEX	NPN	$V_{CB0}=50B; I_C=500_{MA}; P_D=330_{MBT}; h_{21}=100...600; f_T=200_{MГц}$	B	E	C
6E	BC818-16	CDIL	NPN	$V_{CB0}=50B; I_C=500_{MA}; P_D=330_{MBT}; h_{21}=100...250; f_T>170_{MГц}$	B	E	C
6E	FMMTA93R	ZETEX	NPN	$V_{CB0}=-200B; I_C=-200_{MA}; P_D=330_{MBT}; h_{21}=30...150; f_T>50_{MГц}$	B	E	C
6Ep	BC818-16	PHIL	NPN	$V_{CB0}=25B; I_C=500_{MA}; P_D=250_{MBT}; h_{21}=100...250; f_T>80_{MГц}$	B	E	C
6ER	BC818-16R	PHIL	NPN	$V_{CB0}=25B; I_C=500_{MA}; P_D=310_{MBT}; h_{21}=250; f_T>200_{MГц}$	E	B	C
6Es	BC818-16	SIEM	NPN	$V_{CB0}=30B; I_C=500_{MA}; P_D=330_{MBT}; h_{21}=100...250; f_T=170_{MГц}$	B	E	C

SOT23, SOD23 (продолжение)

Код	Типономинал	Фирма	Функция	Особенности	Цоколевка		
					1	2	3
6EZ	BC818-16	ZETEX	NPN	$V_{CB0}=30B; I_C=500_{MA}; P_D=330_{MBT}; h_{21}=100...250;$ $f_T>200_{MГц}$	B	E	C
6F	BC818-25	CDIL	NPN	$V_{CB0}=30B; I_C=500_{MA}; P_D=330_{MBT}; h_{21}=160...400;$ $f_T>170_{MГц}$	B	E	C
6Fp	BC818-25	PHIL	NPN	$V_{CB0}=25B; I_C=500_{MA}; P_D=250_{MBT}; h_{21}=160...400;$ $f_T>80_{MГц}$	B	E	C
6FR	BC818-25R	PHIL	NPN	$V_{CB0}=25B; I_C=500_{MA}; P_D=310_{MBT}; h_{21}=400; f_T>200_{MГц}$	E	B	C
6Fs	BC818-25W	SIEM	NPN	$V_{CB0}=30B; I_C=500_{MA}; P_D=250_{MBT}; h_{21}=160...400;$ $f_T>170_{MГц}$	B	E	C
6Fs	BC818-25	SIEM	NPN	$V_{CB0}=30B; I_C=500_{MA}; P_D=330_{MBT}; h_{21}=160...400;$ $f_T=170_{MГц}$	B	E	C
6FZ	BC818-25	ZETEX	NPN	$V_{CB0}=30B; I_C=500_{MA}; P_D=330_{MBT}; h_{21}=160...400;$ $f_T>200_{MГц}$	B	E	C
6G	BC818-40	CDIL	NPN	$V_{CB0}=25B; I_C=500_{MA}; P_D=250_{MBT}; h_{21}=250...600;$ $f_T>80_{MГц}$	B	E	C
6G	CMPF4393	CENTS	nFET	$V_{GSS}>40B; I_{DSS}=5...30_{MA}; V_{GS(off)}=0.5...3B;$ $R_{DS(on)}<100_{OM}; t_{OFF}<50_{HC};$	D	S	G
6G	FMMV2103	ZETEX	BD	$V_R<30B; C_{3V}=9...11_{пФ}; C_{2V}/C_{30V}=2.6...3.3; Q>400$	A	nc	K
6Gp	BC818-40	PHIL	NPN	$V_{CB0}=25B; I_C=500_{MA}; P_D=250_{MBT}; h_{21}=250...600;$ $f_T>80_{MГц}$	B	E	C
6GR	BC818-40R	PHIL	NPN	$V_{CB0}=25B; I_C=500_{MA}; P_D=310_{MBT}; h_{21}=600; f_T>200_{MГц}$	E	B	C
6Gs	BC818-40	SIEM	NPN	$V_{CB0}=30B; I_C=500_{MA}; P_D=330_{MBT}; h_{21}=250...630;$ $f_T>170_{MГц}$	B	E	C
6GZ	BC818-40	ZETEX	NPN	$V_{CB0}=30B; I_C=500_{MA}; P_D=330_{MBT}; h_{21}=250...630;$ $f_T>200_{MГц}$	B	E	C
6H	BC818	CDIL	NPN	$V_{CB0}=25B; I_C=500_{MA}; P_D=250_{MBT}; h_{21}=50...600;$ $f_T>80_{MГц}$	B	E	C
6H	FMMV2104	ZETEX	BD	$V_R<30B; C_{4V}=10.8...13.2_{пФ}; C_{3V}/C_{25V}=2.6...3.3; Q>400$	A	nc	K
6Hp	BC818	PHIL	NPN	$V_{CB0}=25B; I_C=500_{MA}; P_D=250_{MBT}; h_{21}=100...600;$ $f_T>80_{MГц}$	B	E	C
6HZ	BC818	ZETEX	NPN	$V_{CB0}=30B; I_C=500_{MA}; P_D=330_{MBT}; h_{21}=100...600;$ $f_T>200_{MГц}$	B	E	C
6J	CMPF4391	CENTS	nFET	$V_{GSS}>40B; I_{DSS}=50...150_{MA}; V_{GS(off)}=4...10B;$ $R_{DS(on)}<300_{OM}; t_{OFF}<20_{HC};$	D	G	S
6J	FMMV2105	ZETEX	BD	$V_R<30B; C_{4V}=13.5...16.5_{пФ}; C_{2V}/C_{30V}=2.6...3.3; Q>400$	A	nc	K
6K	CMPF4392	CENTS	nFET	$V_{GSS}>40B; I_{DSS}=25...75_{MA}; V_{GS(off)}=2...5B;$ $R_{DS(on)}<60_{OM}; t_{OFF}<35_{HC};$	D	G	S
6L	FMMV2107	ZETEX	BD	$V_R<30B; C_{4V}=19.8...24.2_{пФ}; C_{2V}/C_{30V}=2.7...3.3; Q>350$	A	nc	K
6M	FMMV2108	ZETEX	BD	$V_R<30B; C_{4V}=24.3...29.7_{пФ}; C_{2V}/C_{30V}=2.7...3.3; Q>350$	A	nc	K
6N	FMMV2109	ZETEX	BD	$V_R<30B; C_{4V}=29.3...36.3_{пФ}; C_{2V}/C_{30V}=2.7...3.3; Q>280$	A	nc	K
6P	BCX71HR	ZETEX	PNP	$V_{CB0}=-45B; I_C=-200_{MA}; P_D=330_{MBT}; h_{21}=180...310;$ $f_T>180_{MГц}$	B	E	C
6R	FMMV2104	ZETEX	BD	$V_R<30B; C_{4V}=6.1...7.5_{пФ}; C_{2V}/C_{30V}=2.5...3.3; Q>450$	A	nc	K
6V	BCW65CR	ZETEX	NPN	$V_{CB0}=60B; I_C=800_{MA}; P_D=330_{MBT}; h_{21}=250...630;$ $f_T>100_{MГц}$	B	E	C
6W	BCW67CR	ZETEX	PNP	$V_{CB0}=-45B; I_C=-800_{MA}; P_D=330_{MBT}; h_{21}=250...630;$ $f_T>100_{MГц}$	B	E	C
702	2N7002	VISH	nFET	$V_{DSS}=60B; I_P=115_{MA}; P_D=200_{MBT}; V_{GS}<2.5B; C_{CC}=60_{пФ}$	G	S	D
717	FMMT717	ZETEX	PNP	$V_{CB0}=-12B; I_C=-250_{MA}; P_D=625_{MBT}$	B	E	C
718	FMMT718	ZETEX	PNP	$V_{CB0}=-20B; I_C=-1500_{MA}; P_D=625_{MBT}; h_{21}=300...450;$ $f_T>180_{MГц}$	B	E	C
720	FMMT720	ZETEX	PNP	$V_{CB0}=-40B; I_C=-1500_{MA}; P_D=625_{MBT}; h_{21}=300...450;$ $f_T>190_{MГц}$	B	E	C
722	FMMT722	ZETEX	PNP	$V_{CB0}=-70B; I_C=-1500_{MA}; P_D=625_{MBT}; h_{21}=300...450;$ $f_T>200_{MГц}$	B	E	C
723	FMMT723	ZETEX	PNP	$V_{CB0}=-100B; I_C=-1000_{MA}; P_D=625_{MBT}; h_{21}=300...450;$ $f_T>200_{MГц}$	B	E	C
73	BAS70	VISH	SHD	$V_R<75B; I_F<300_{MA}; V_F(I_F=10_{MA})<1.0B; I_R<5.0_{мкА};$ $C_D<4_{пФ}; t_{RR}<6_{HC}$	A	nc	K
73p	BAS70	PHIL	SHD	$V_R<70B; I_F<70_{MA}; V_F(I_F=1_{MA})<410B; C_D<2_{пФ};$	A	nc	K
73s	BAS70	SIEM	SHD	$V_R<70B; I_F<70_{MA}; V_F(I_F=15_{MA})<1.0B; I_R<0.1_{мкА};$ $C_D<2.0_{пФ};$	A	nc	K
74	BAS70-04	VISH	2xSHD	$V_R<70B; I_F<200_{MA}; V_F(I_F=15_{MA})<1.0B; I_R<0.1_{мкА};$ $C_D<2_{пФ}; t_{RR}<5_{HC}$	A1	K2	K1 A2
74p	BAS70-04	PHIL	2xSHD	$V_R<70B; I_F<70_{MA}; V_F(I_F=1_{MA})<410B; C_D<2_{пФ};$	A1	K2	K1 A2
74s	BAS70-04	SIEM	2xSHD	$V_R<70B; I_F<70_{MA}; V_F(I_F=15_{MA})<1.0B; I_R<0.1_{мкА};$ $C_D<2.0_{пФ};$	A1	K2	K1 A2
75	BAS70-05	VISH	2xSHD	$V_R<70B; I_F<200_{MA}; V_F(I_F=15_{MA})<1.0B; I_R<0.1_{мкА};$ $C_D<2.0_{пФ}; t_{RR}<5_{HC}$	A1	A2	K1 K2

SOT23, SOD23 (продолжение)

Код	Типономинал	Фирма	Функция	Особенности	Цоколевка		
					1	2	3
75p	BAS70-05	PHIL	2xSHD	$V_R < 70B; I_F < 70_{mA}; V_F(I_F = 1_{mA}) < 410B; C_D < 2_{пФ};$	A1	A2	K1 K2
75s	BAS70-05	SIEM	2xSHD	$V_R < 70B; I_F < 70_{mA}; V_F(I_F = 15_{mA}) < 1.0B; I_R < 0.1_{мкА}; C_D < 2.0_{пФ};$	A1	A2	K1 K2
76	BAS70-06	VISH	2xSHD	$V_R < 70B; I_F < 200_{mA}; V_F(I_F = 15_{mA}) < 1.0B; I_R < 0.1_{мкА}; C_D < 2.0_{пФ}; t_{RR} < 5_{нс}$	K1	K2	A1 A2
76p	BAS70-06	PHIL	2xSHD	$V_R < 70B; I_F < 70_{mA}; V_F(I_F = 1_{mA}) < 410B; C_D < 2_{пФ};$	K1	K2	A1 A2
76s	BAS70-06	SIEM	2xSHD	$V_R < 70B; I_F < 70_{mA}; V_F(I_F = 15_{mA}) < 1.0B; I_R < 0.1_{мкА}; C_D < 2.0_{пФ};$	K1	K2	A1 A2
7A	MMBR901LT1	MOT	NPN	$V_{CB0} = 25B; I_C = 30_{mA}; P_D = 300_{мВт}; h_{21} = 30 \dots 200;$	B	E	C
7A	MMBR901LT3	MOT	NPN	$V_{CB0} = 25B; I_C = 30_{mA}; P_D = 300_{мВт}; h_{21} = 30 \dots 200;$	B	E	C
7B	MMBR920LT2	MOT	NPN	$V_{CB0} = 20B; I_C = 35_{mA}; P_D = 268_{мВт}; h_{21} = 25 \dots 250; f_T = 4500_{МГц}$	B	E	C
7D	MMBR931LT1	MOT	NPN	$V_{CB0} = 10B; I_C = 5_{mA}; P_D = 150_{мВт}; h_{21} = 50 \dots 150;$	B	E	C
7D	HD4A	ZETEX	2xSHD	$V_R < 35B; I_F < 100_{mA}; V_F(I_F = 10_{mA}) < 1.0B; I_R < 1.0_{мкА}; C_D < 4.0_{пФ}; t_{RR} < 6_{нс}$	K1	K2	A1 A2
7E	FMMTA42R	ZETEX	NPN	$V_{CB0} = 300B; I_C = 200_{mA}; P_D = 330_{мВт}; h_{21} > 40; f_T > 50_{МГц}$	B	E	C
7G	MMBR5031LT1	MOT	NPN	$V_{CB0} = 15B; I_C = 20_{mA}; P_D = 300_{мВт}; h_{21} = 25 \dots 300; f_T = 1000_{МГц}$	B	E	C
7H	MMBR5179LT1	MOT	NPN	$V_{CB0} = 20B; I_C = 50_{mA}; P_D = 375_{мВт}; h_{21} > 25; f_T = 1400_{МГц}$	B	E	C
7H	KST5179	SAMS	NPN	$V_{CB0} = 20B; I_C = 50_{mA}; P_D = 350_{мВт}; h_{21} > 25; f_T > 900_{МГц}$	B	E	C
7J	FMMT38C	ZETEX	NPN	$V_{CB0} = 800B; I_C = 300_{mA}; P_D = 330_{мВт}; h_{21} > 5000$	B	E	C
7M	MMBR521LT1	MOT	NPN	$V_{CB0} = -20B; I_C = -70_{mA}; P_D = 333_{мВт}; h_{21} = 25 \dots 125; f_T = 3400_{МГц}$	B	E	C
7M	BCW66HR	ZETEX	NPN	$V_{CB0} = 75B; I_C = 800_{mA}; P_D = 330_{мВт}; h_{21} = 250 \dots 630; f_T > 100_{МГц}$	B	E	C
7N	MMBR941BLT1	MOT	NPN	$V_{CB0} = 20B; I_C = 50_{mA}; P_D = 250_{мВт}; h_{21} = 100 \dots 200; f_T = 8000_{МГц}$	B	E	C
7N	MMBR941BLT1	MOT	NPN	$V_{CB0} = 20B; I_C = 50_{mA}; P_D = 250_{мВт}; h_{21} = 100 \dots 200; f_T = 8000_{МГц}$	B	E	C
7N	BCW68HR	ZETEX	PNP	$V_{CB0} = -60B; I_C = -800_{mA}; P_D = 330_{мВт}; h_{21} = 250 \dots 630; f_T > 100_{МГц}$	B	E	C
7P	MMBR911BLT1	MOT	NPN	$V_{CB0} = 20B; I_C = 60_{mA}; P_D = 300_{мВт}; h_{21} = 30 \dots 200; f_T = 6000_{МГц}$	B	E	C
7P	BCW66HR	ZETEX	NPN	$V_{CB0} = 75B; I_C = 800_{mA}; P_D = 330_{мВт}; h_{21} = 100 \dots 250; f_T > 100_{МГц}$	B	E	C
7T	BCW68FR	ZETEX	PNP	$V_{CB0} = -60B; I_C = -800_{mA}; P_D = 330_{мВт}; h_{21} = 100 \dots 250; f_T > 100_{МГц}$	B	E	C
7X	MMBR571LT1	MOT	NPN	$V_{CB0} = 20B; I_C = 80_{mA}; P_D = 330_{мВт}; h_{21} = 50 \dots 300; f_T = 8000_{МГц}$	B	E	C
7Y	MMBR941LT1	MOT	NPN	$V_{CB0} = 20B; I_C = 50_{mA}; P_D = 250_{мВт}; h_{21} = 50 \dots 200; f_T = 8000_{МГц}$	B	E	C
7Y	MMBR941LT3	MOT	NPN	$V_{CB0} = 20B; I_C = 50_{mA}; P_D = 250_{мВт}; h_{21} = 50 \dots 250; f_T = 8000_{МГц}$	B	E	C
7Z	MMBR951LT1	MOT	NPN	$V_{CB0} = 20B; I_C = 100_{mA}; P_D = 322_{мВт}; h_{21} = 50 \dots 200; f_T = 8000_{МГц}$	B	E	C
81A	TMPZ5250	ALLEG	DZ	$V_Z(I_{ZT} = 6.2_{mA}) = 19.0 \dots 21.0B; I_L(V_R = 15.0B) < 0.1_{мкА}; Z_{ZT}(I_{ZT} = 6.2_{mA}) < 25_{Ом}$	A	nc	K
81A	PMBZ5250B	PHIL	DZ	$V_Z(I_{ZT} = 6.2_{mA}) = 20B; I_L(V_R = 15B) < 0.1_{мкА}; Z_{ZT}(I_{ZT} = 6.2_{mA}) < 600_{Ом}; I_{ZM} = 200_{mA}$	A	nc	K
81B	TMPZ5251	ALLEG	DZ	$V_Z(I_{ZT} = 5.5_{mA}) = 20.9 \dots 23.1B; I_L(V_R = 17.0B) < 0.1_{мкА}; Z_{ZT}(I_{ZT} = 5.5_{mA}) < 29_{Ом}$	A	nc	K
81B	PMBZ5251B	PHIL	DZ	$V_Z(I_{ZT} = 5.6_{mA}) = 22B; I_L(V_R = 17B) < 0.1_{мкА}; Z_{ZT}(I_{ZT} = 5.6_{mA}) < 600_{Ом}; I_{ZM} = 200_{mA}$	A	nc	K
81C	TMPZ5252	ALLEG	DZ	$V_Z(I_{ZT} = 5.2_{mA}) = 22.8 \dots 25.2B; I_L(V_R = 18.0B) < 0.1_{мкА}; Z_{ZT}(I_{ZT} = 5.2_{mA}) < 33_{Ом}$	A	nc	K
81C	PMBZ5252B	PHIL	DZ	$V_Z(I_{ZT} = 5.2_{mA}) = 24B; I_L(V_R = 18B) < 0.1_{мкА}; Z_{ZT}(I_{ZT} = 5.2_{mA}) < 600_{Ом}; I_{ZM} = 200_{mA}$	A	nc	K
81D	TMPZ5253	ALLEG	DZ	$V_Z(I_{ZT} = 5.0_{mA}) = 23.8 \dots 26.3B; I_L(V_R = 19.0B) < 0.1_{мкА}; Z_{ZT}(I_{ZT} = 5.0_{mA}) < 35_{Ом}$	A	nc	K
81D	PMBZ5253B	PHIL	DZ	$V_Z(I_{ZT} = 5.0_{mA}) = 25B; I_L(V_R = 19B) < 0.1_{мкА}; Z_{ZT}(I_{ZT} = 5.0_{mA}) < 600_{Ом}; I_{ZM} = 200_{mA}$	A	nc	K
81E	TMPZ5254	ALLEG	DZ	$V_Z(I_{ZT} = 4.6_{mA}) = 25.7 \dots 28.4B; I_L(V_R = 21.0B) < 0.1_{мкА}; Z_{ZT}(I_{ZT} = 4.6_{mA}) < 41_{Ом}$	A	nc	K
81E	PMBZ5254B	PHIL	DZ	$V_Z(I_{ZT} = 4.6_{mA}) = 27B; I_L(V_R = 21B) < 0.1_{мкА}; Z_{ZT}(I_{ZT} = 4.6_{mA}) < 600_{Ом}; I_{ZM} = 200_{mA}$	A	nc	K
81F	TMPZ5255	ALLEG	DZ	$V_Z(I_{ZT} = 4.5_{mA}) = 26.6 \dots 29.4B; I_L(V_R = 21.0B) < 0.1_{мкА}; Z_{ZT}(I_{ZT} = 4.5_{mA}) < 44_{Ом}$	A	nc	K
81F	PMBZ5255B	PHIL	DZ	$V_Z(I_{ZT} = 4.5_{mA}) = 28B; I_L(V_R = 21B) < 0.1_{мкА}; Z_{ZT}(I_{ZT} = 4.5_{mA}) < 600_{Ом}; I_{ZM} = 200_{mA}$	A	nc	K

SOT23, SOD23 (продолжение)

Код	Типономинал	Фирма	Функция	Особенности	Цоколевка		
					1	2	3
81G	TMPZ5256	ALLEG	DZ	$V_Z(I_{ZT}=4.2\text{mA})=28.5\dots31.5\text{B}$; $I_L(V_R=23.0\text{B})<0.1\text{мкА}$; $Z_{ZT}(I_{ZT}=4.2\text{mA})<490\text{Ом}$	A	nc	K
81G	PMBZ5256B	PHIL	DZ	$V_Z(I_{ZT}=4.2\text{mA})=30\text{B}$; $I_L(V_R=23\text{B})<0.1\text{мкА}$; $Z_{ZT}(I_{ZT}=4.2\text{mA})<600\text{Ом}$; $I_{ZM}=200\text{mA}$	A	nc	K
81H	TMPZ5257	ALLEG	DZ	$V_Z(I_{ZT}=4.5\text{mA})=31.4\dots34.7\text{B}$; $I_L(V_R=25.0\text{B})<0.1\text{мкА}$; $Z_{ZT}(I_{ZT}=3.8\text{mA})<580\text{Ом}$	A	nc	K
81H	PMBZ5257B	PHIL	DZ	$V_Z(I_{ZT}=3.8\text{mA})=33\text{B}$; $I_L(V_R=25\text{B})<0.1\text{мкА}$; $Z_{ZT}(I_{ZT}=3.8\text{mA})<600\text{Ом}$; $I_{ZM}=200\text{mA}$	A	nc	K
83	BAT68	SIEM	SHD	$V_R<8\text{B}$; $I_F<130\text{mA}$; $V_F(I_F=10\text{mA})<0.5\text{B}$; $I_R<0.1\text{мкА}$; $C_D<1.0\text{пФ}$;	A	nc	K
84	BAT68-04	SIEM	2xSHD	$V_R<8\text{B}$; $I_F<130\text{mA}$; $V_F(I_F=10\text{mA})<0.5\text{B}$; $I_R<0.1\text{мкА}$; $C_D<1.0\text{пФ}$;	A1	K2	K1 A2
85	BAT68-05	SIEM	2xSHD	$V_R<8\text{B}$; $I_F<130\text{mA}$; $V_F(I_F=10\text{mA})<0.5\text{B}$; $I_R<0.1\text{мкА}$; $C_D<1.0\text{пФ}$;	A1	A2	K1 K2
86	BAT68-06	SIEM	2xSHD	$V_R<8\text{B}$; $I_F<130\text{mA}$; $V_F(I_F=10\text{mA})<0.5\text{B}$; $I_R<0.1\text{мкА}$; $C_D<1.0\text{пФ}$;	K1	K2	A1 A2
8A	MUN5211T1	MOT	NPN	$V_{CB0}=50\text{B}$; $I_C=50\text{mA}$; $P_D=150\text{мВт}$; $h_{21}>35$	E	B	C
8AA	BC846A	SAMS	NPN	$V_{CB0}=80\text{B}$; $I_C=100\text{mA}$; $P_D=310\text{мВт}$; $h_{21}=110\dots220$; $f_T>300\text{МГц}$	B	E	C
8AB	BC846B	SAMS	NPN	$V_{CB0}=80\text{B}$; $I_C=100\text{mA}$; $P_D=310\text{мВт}$; $h_{21}=200\dots450$; $f_T>300\text{МГц}$	B	E	C
8AC	BC846C	SAMS	NPN	$V_{CB0}=80\text{B}$; $I_C=100\text{mA}$; $P_D=310\text{мВт}$; $h_{21}=420\dots800$; $f_T>300\text{МГц}$	B	E	C
8B	MUN5212T1	MOT	NPN	$V_{CB0}=50\text{B}$; $I_C=50\text{mA}$; $P_D=150\text{мВт}$; $h_{21}>60$	E	B	C
8BB	BC847B	SAMS	NPN	$V_{CB0}=50\text{B}$; $I_C=100\text{mA}$; $P_D=310\text{мВт}$; $h_{21}=200\dots450$; $f_T>300\text{МГц}$	B	E	C
8BC	BC847C	SAMS	NPN	$V_{CB0}=50\text{B}$; $I_C=100\text{mA}$; $P_D=310\text{мВт}$; $h_{21}=420\dots800$; $f_T>300\text{МГц}$	B	E	C
8C	MUN5213T1	MOT	NPN	$V_{CB0}=50\text{B}$; $I_C=50\text{mA}$; $P_D=150\text{мВт}$; $h_{21}>80$	E	B	C
8CA	BC848A	SAMS	NPN	$V_{CB0}=30\text{B}$; $I_C=100\text{mA}$; $P_D=310\text{мВт}$; $h_{21}=110\dots220$; $f_T>300\text{МГц}$	B	E	C
8CB	BC848B	SAMS	NPN	$V_{CB0}=30\text{B}$; $I_C=100\text{mA}$; $P_D=310\text{мВт}$; $h_{21}=200\dots450$; $f_T>300\text{МГц}$	B	E	C
8CC	BC848C	SAMS	NPN	$V_{CB0}=30\text{B}$; $I_C=100\text{mA}$; $P_D=310\text{мВт}$; $h_{21}=420\dots800$; $f_T>300\text{МГц}$	B	E	C
8D	TMPZ5229	ALLEG	DZ	$V_Z(I_{ZT}=20\text{mA})=4.08\dots4.52\text{B}$; $I_L(V_R=1.0\text{B})<5.0\text{мкА}$; $Z_{ZT}(I_{ZT}=20\text{mA})<220\text{Ом}$	A	nc	K
8D	MUN5214T1	MOT	NPN	$V_{CB0}=50\text{B}$; $I_C=50\text{mA}$; $P_D=150\text{мВт}$; $h_{21}>80$	E	B	C
8DA	BC849A	SAMS	NPN	$V_{CB0}=30\text{B}$; $I_C=100\text{mA}$; $P_D=310\text{мВт}$; $h_{21}=110\dots220$; $f_T>300\text{МГц}$	B	E	C
8DB	BC849B	SAMS	NPN	$V_{CB0}=30\text{B}$; $I_C=100\text{mA}$; $P_D=310\text{мВт}$; $h_{21}=200\dots450$; $f_T>300\text{МГц}$	B	E	C
8DC	BC849C	SAMS	NPN	$V_{CB0}=30\text{B}$; $I_C=100\text{mA}$; $P_D=310\text{мВт}$; $h_{21}=420\dots800$; $f_T>300\text{МГц}$	B	E	C
8E	TMPZ5230	ALLEG	DZ	$V_Z(I_{ZT}=20\text{mA})=4.47\dots4.94\text{B}$; $I_L(V_R=2.0\text{B})<5.0\text{мкА}$; $Z_{ZT}(I_{ZT}=20\text{mA})<190\text{Ом}$	A	nc	K
8E	MUN5215T1	MOT	NPN	$V_{CB0}=50\text{B}$; $I_C=50\text{mA}$; $P_D=150\text{мВт}$; $h_{21}>160$	E	B	C
8E	FMMTA92R	ZETEX	PNP	$V_{CB0}=-300\text{B}$; $I_C=-200\text{mA}$; $P_D=330\text{мВт}$; $h_{21}>25$; $f_T>50\text{МГц}$	B	E	C
8EA	BC850A	SAMS	NPN	$V_{CB0}=50\text{B}$; $I_C=100\text{mA}$; $P_D=310\text{мВт}$; $h_{21}=110\dots220$; $f_T>300\text{МГц}$	B	E	C
8EB	BC850B	SAMS	NPN	$V_{CB0}=50\text{B}$; $I_C=100\text{mA}$; $P_D=310\text{мВт}$; $h_{21}=200\dots450$; $f_T>300\text{МГц}$	B	E	C
8EC	BC850C	SAMS	NPN	$V_{CB0}=50\text{B}$; $I_C=100\text{mA}$; $P_D=310\text{мВт}$; $h_{21}=420\dots800$; $f_T>300\text{МГц}$	B	E	C
8F	TMPZ5231	ALLEG	DZ	$V_Z(I_{ZT}=20\text{mA})=4.85\dots5.36\text{B}$; $I_L(V_R=2.0\text{B})<5.0\text{мкА}$; $Z_{ZT}(I_{ZT}=20\text{mA})<170\text{Ом}$	A	nc	K
8F	MUN5216T1	MOT	NPN	$V_{CB0}=50\text{B}$; $I_C=50\text{mA}$; $P_D=150\text{мВт}$; $h_{21}>160$	E	B	C
8FA	BC817-16	SAMS	NPN	$V_{CB0}=50\text{B}$; $I_C=800\text{mA}$; $P_D=310\text{мВт}$; $h_{21}=100\dots250$; $f_T=100\text{МГц}$	B	E	C
8FB	BC817-25	SAMS	NPN	$V_{CB0}=50\text{B}$; $I_C=800\text{mA}$; $P_D=310\text{мВт}$; $h_{21}=160\dots400$; $f_T=100\text{МГц}$	B	E	C
8FC	BC817-40	SAMS	NPN	$V_{CB0}=50\text{B}$; $I_C=800\text{mA}$; $P_D=310\text{мВт}$; $h_{21}=250\dots630$; $f_T=100\text{МГц}$	B	E	C
8G	TMPZ5232	ALLEG	DZ	$V_Z(I_{ZT}=20\text{mA})=5.32\dots5.88\text{B}$; $I_L(V_R=3.0\text{B})<5.0\text{мкА}$; $Z_{ZT}(I_{ZT}=20\text{mA})<110\text{Ом}$	A	nc	K
8G	MUN5230T1	MOT	NPN	$V_{CB0}=50\text{B}$; $I_C=50\text{mA}$; $P_D=150\text{мВт}$; $h_{21}>3$	E	B	C
8GA	BC817-16	SAMS	NPN	$V_{CB0}=30\text{B}$; $I_C=800\text{mA}$; $P_D=310\text{мВт}$; $h_{21}=100\dots250$; $f_T=100\text{МГц}$	B	E	C
8GB	BC817-25	SAMS	NPN	$V_{CB0}=30\text{B}$; $I_C=800\text{mA}$; $P_D=310\text{мВт}$; $h_{21}=160\dots400$; $f_T=100\text{МГц}$	B	E	C

SOT23, SOD23 (продолжение)

Код	Типономинал	Фирма	Функция	Особенности	Цоколевка		
					1	2	3
8GC	BC817-40	SAMS	NPN	$V_{CB0}=50B; I_C=800mA; P_D=310mBT; h_{21}=250...630; f_T=100MГц$	B	E	C
8H	TMPZ5233	ALLEG	DZ	$V_Z(I_{ZT}=20mA)=5.70...6.30B; I_L(V_R=3.5B)<5.0mA; Z_{ZT}(I_{ZT}=20mA)<7.0Oм$	A	nc	K
8H	MUN5231T1	MOT	NPN	$V_{CB0}=50B; I_C=50mA; P_D=150mBT; h_{21}>8$	E	B	C
8J	TMPZ5234	ALLEG	DZ	$V_Z(I_{ZT}=20mA)=5.98...6.51B; I_L(V_R=4.0B)<3.0mA; Z_{ZT}(I_{ZT}=20mA)<7.0Oм$	A	nc	K
8J	MUN5232T1	MOT	NPN	$V_{CB0}=50B; I_C=50mA; P_D=150mBT; h_{21}>15$	E	B	C
8K	TMPZ5235	ALLEG	DZ	$V_Z(I_{ZT}=20mA)=6.46...7.14B; I_L(V_R=5.0B)<3.0mA; Z_{ZT}(I_{ZT}=20mA)<5.0Oм$	A	nc	K
8K	MUN5233T1	MOT	NPN	$V_{CB0}=50B; I_C=50mA; P_D=150mBT; h_{21}>80$	E	B	C
8L	TMPZ5236	ALLEG	DZ	$V_Z(I_{ZT}=20mA)=7.13...7.88B; I_L(V_R=6.0B)<3.0mA; Z_{ZT}(I_{ZT}=20mA)<6.0Oм$	A	nc	K
8L	MUN5234T1	MOT	NPN	$V_{CB0}=50B; I_C=50mA; P_D=150mBT; h_{21}>80$	E	B	C
8M	TMPZ5237	ALLEG	DZ	$V_Z(I_{ZT}=20mA)=7.79...8.61B; I_L(V_R=6.5B)<3.0mA; Z_{ZT}(I_{ZT}=20mA)<8.0Oм$	A	nc	K
8N	TMPZ5238	ALLEG	DZ	$V_Z(I_{ZT}=20mA)=8.26...9.14B; I_L(V_R=6.5B)<3.0mA; Z_{ZT}(I_{ZT}=20mA)<8.0Oм$	A	nc	K
8P	TMPZ5239	ALLEG	DZ	$V_Z(I_{ZT}=20mA)=8.65...9.56B; I_L(V_R=7.0B)<3.0mA; Z_{ZT}(I_{ZT}=20mA)<10Oм$	A	nc	K
8Q	TMPZ5240	ALLEG	DZ	$V_Z(I_{ZT}=20mA)=9.50...10.5B; I_L(V_R=8.0B)<3.0mA; Z_{ZT}(I_{ZT}=20mA)<17Oм$	A	nc	K
8R	TMPZ5241	ALLEG	DZ	$V_Z(I_{ZT}=20mA)=10.5...11.6B; I_L(V_R=8.4B)<2.0mA; Z_{ZT}(I_{ZT}=20mA)<22Oм$	A	nc	K
8S	TMPZ5242	ALLEG	DZ	$V_Z(I_{ZT}=20mA)=11.4...12.6B; I_L(V_R=9.1B)<1.0mA; Z_{ZT}(I_{ZT}=20mA)<30Oм$	A	nc	K
8T	TMPZ5243	ALLEG	DZ	$V_Z(I_{ZT}=9.5mA)=12.4...13.7B; I_L(V_R=9.9B)<0.5mA; Z_{ZT}(I_{ZT}=9.5mA)<13Oм$	A	nc	K
8U	TMPZ5244	ALLEG	DZ	$V_Z(I_{ZT}=9.0mA)=13.3...14.7B; I_L(V_R=10.0B)<0.1mA; Z_{ZT}(I_{ZT}=9.0mA)<15Oм$	A	nc	K
8V	TMPZ5245	ALLEG	DZ	$V_Z(I_{ZT}=8.5mA)=14.3...15.8B; I_L(V_R=11.0B)<0.1mA; Z_{ZT}(I_{ZT}=8.5mA)<16Oм$	A	nc	K
8W	TMPZ5246	ALLEG	DZ	$V_Z(I_{ZT}=7.8mA)=15.2...16.8B; I_L(V_R=12.0B)<0.1mA; Z_{ZT}(I_{ZT}=7.8mA)<17Oм$	A	nc	K
8X	TMPZ5247	ALLEG	DZ	$V_Z(I_{ZT}=7.4mA)=16.2...17.9B; I_L(V_R=13.0B)<0.1mA; Z_{ZT}(I_{ZT}=7.4mA)<19Oм$	A	nc	K
8Y	TMPZ5248	ALLEG	DZ	$V_Z(I_{ZT}=7.0mA)=17.1...18.9B; I_L(V_R=14.0B)<0.1mA; Z_{ZT}(I_{ZT}=7.0mA)<21Oм$	A	nc	K
8Z	TMPZ5249	ALLEG	DZ	$V_Z(I_{ZT}=6.6mA)=18.1...20.0B; I_L(V_R=14.0B)<0.1mA; Z_{ZT}(I_{ZT}=6.6mA)<23Oм$	A	nc	K
9A	FMMTA92R	ZETEX	NPN	$V_{CB0}=40B; I_C=200mA; P_D=330mBT; h_{21}=40...120$	B	E	C
9AA	BC856A	SAMS	PNP	$V_{CB0}=-80B; I_C=-100mA; P_D=310mBT; h_{21}=110...220; f_T>150MГц$	B	E	C
9AB	BC856B	SAMS	PNP	$V_{CB0}=-80B; I_C=-100mA; P_D=310mBT; h_{21}=200...450; f_T>150MГц$	B	E	C
9AC	BC856C	SAMS	PNP	$V_{CB0}=-80B; I_C=-100mA; P_D=310mBT; h_{21}=420...800; f_T>150MГц$	B	E	C
9BA	BC857A	SAMS	PNP	$V_{CB0}=-50B; I_C=-100mA; P_D=310mBT; h_{21}=110...220; f_T>150MГц$	B	E	C
9BB	BC857B	SAMS	PNP	$V_{CB0}=-50B; I_C=-100mA; P_D=310mBT; h_{21}=200...450; f_T>150MГц$	B	E	C
9BC	BC857C	SAMS	PNP	$V_{CB0}=-50B; I_C=-100mA; P_D=310mBT; h_{21}=420...800; f_T>150MГц$	B	E	C
9CA	BC858A	SAMS	PNP	$V_{CB0}=-30B; I_C=-100mA; P_D=310mBT; h_{21}=110...220; f_T>150MГц$	B	E	C
9CB	BC858B	SAMS	PNP	$V_{CB0}=-30B; I_C=-100mA; P_D=310mBT; h_{21}=200...450; f_T>150MГц$	B	E	C
9CC	BC858C	SAMS	PNP	$V_{CB0}=-30B; I_C=-100mA; P_D=310mBT; h_{21}=420...800; f_T>150MГц$	B	E	C
9DA	BC859A	SAMS	PNP	$V_{CB0}=-30B; I_C=-100mA; P_D=310mBT; h_{21}=110...220; f_T>150MГц$	B	E	C
9DB	BC859B	SAMS	PNP	$V_{CB0}=-30B; I_C=-100mA; P_D=310mBT; h_{21}=200...450; f_T>150MГц$	B	E	C
9DC	BC859C	SAMS	PNP	$V_{CB0}=-30B; I_C=-100mA; P_D=310mBT; h_{21}=420...800; f_T>150MГц$	B	E	C
9EA	BC860A	SAMS	PNP	$V_{CB0}=-50B; I_C=-100mA; P_D=310mBT; h_{21}=110...220; f_T>150MГц$	B	E	C
9EB	BC860B	SAMS	PNP	$V_{CB0}=-50B; I_C=-100mA; P_D=310mBT; h_{21}=200...450; f_T>150MГц$	B	E	C
9EC	BC860C	SAMS	PNP	$V_{CB0}=-50B; I_C=-100mA; P_D=310mBT; h_{21}=420...800; f_T>150MГц$	B	E	C
9FA	BC807-16	SAMS	NPN	$V_{CB0}=-50B; I_C=-800mA; P_D=310mBT; h_{21}=100...250; f_T>100MГц$	B	E	C

SOT23, SOD23 (продолжение)

Код	Типономинал	Фирма	Функция	Особенности	Цоколевка		
					1	2	3
9FB	BC807-25	SAMS	NPN	$V_{CB0}=-50B; I_C=-100_{MA}; P_D=310_{MBT}; h_{21}=160...400; f_T>100_{MГц}$	B	E	C
9FC	BC807-40	SAMS	NPN	$V_{CB0}=-50B; I_C=-100_{MA}; P_D=310_{MBT}; h_{21}=250...630; f_T>100_{MГц}$	B	E	C
9GA	BC808-16	SAMS	NPN	$V_{CB0}=-30B; I_C=-800_{MA}; P_D=310_{MBT}; h_{21}=100...250; f_T>100_{MГц}$	B	E	C
9GB	BC808-25	SAMS	NPN	$V_{CB0}=-30B; I_C=-800_{MA}; P_D=310_{MBT}; h_{21}=160...400; f_T>100_{MГц}$	B	E	C
9GC	BC808-40	SAMS	NPN	$V_{CB0}=-30B; I_C=-800_{MA}; P_D=310_{MBT}; h_{21}=250...630; f_T>100_{MГц}$	B	E	C
9P	BCX70HR	ZETEX	NPN	$V_{CB0}=45B; I_C=200_{MA}; P_D=330_{MBT}; h_{21}=180...310; f_T>250_{MГц}$	B	E	C
9R	FMMT2369R	ZETEX	NPN	$V_{CB0}=40B; I_C=200_{MA}; P_D=330_{MBT}; h_{21}=40...120$	B	E	C
A0	HSMS-2800	HP	SHD	$V_{BR}>70; V_F(I_F=15_{MA})<1.0B; I_R(V_R=50B)<200_{HA}; C_D<2.0_{пФ}$	A	nc	K
A1	BAW56	ALLEG	2xD	$I_F<70_{MA}; V_{BR}>70; V_F(I_F=50_{MA})<1.1B; I_R<2500_{HA}; t_{RR}<6.0_{HC}; C_D<2.0_{пФ}$	K1	K2	A1 A2
A1	BAW56	VISH	2xDI	$V_R<70B; I_F<300_{MA}; V_F(I_F=150_{MA})<1.25B; I_R<5.0_{мкA}; C_D<4.0_{пФ}; t_{RR}<6_{HC}$	K1	K2	A1 A2
A1	BAW56	ZETEX	2xDI	$V_R<70B; I_F<100_{MA}; V_F(I_F=50_{MA})<1.1B; I_R<2.5_{мкA}; C_D<2.0_{пФ}; t_{RR}<6_{HC}$	K1	K2	A1 A2
A16	ZC934A	ZETEX	BD	$V_R<12B; C_D(V_R=2.5B)=47.25...57.75_{пФ}; C_{IV}/C_{4V}<3.8; Q>80$	A	nc	K
A17	ZC933A	ZETEX	BD	$V_R<12B; C_D(V_R=2.5B)=20.25...24.75_{пФ}; C_{IV}/C_D(4B)<3.5; Q>150$	A	nc	K
A1p	BAW56	PHIL	2xFD	$V_R<75B; I_F<215_{MA}; V_F(I_F=50_{MA})<1.0B; C_D<2_{пФ}; t_{RR}<4_{HC}$	K1	K2	A1 A2
A1s	BAW56	SIEM	2xDI	$V_R<70B; I_F<200_{MA}; V_F(I_F=150_{MA})<1.25B; I_R<2.5_{мкA}; C_D<2.0_{пФ}; t_{RR}<6_{HC}$	K1	K2	A1 A2
A2	HSMS-2802	HP	2xSHD	$V_{BR}>70; V_F(I_F=15_{MA})<1.0B; I_R(V_R=50B)<200_{HA}; C_D<2.0_{пФ}$	A1	K2	K1 A2
A2	BAT18	PHIL	DTV	$V_R<35B; I_F<100_{MA}; R_D<0.70_{OM}; C_D<1.0_{пФ}$	A	nc	K
A2	BAT18	SIEM	CPIN	$V_R<35B; I_F<100_{MA}; V_F(I_F=100_{MA})<1.2B; I_R<0.02_{мкA}; C_D<1.0_{пФ};$	A	nc	K
A2	MMBD4148	VISH	DI	$V_R<75B; I_F<300_{MA}; V_F(I_F=10_{MA})<1.0B; I_R<5.0_{мкA}; C_D<4_{пФ}; t_{RR}<6_{HC}$	A	nc	K
A2	FMMD2836	ZETEX	2xFID	$V_R<75B; I_F<100_{MA}; V_F(I_F=50_{MA})<1.0B; I_R<0.1_{мкA}; C_D<4.0_{пФ}; t_{RR}<6_{HC}$	K1	K2	A1 A2
A3	HSMS-2803	HP	2xSHD	$V_R<70B; V_F(I_F=15_{MA})<1.0B; I_R(V_R=50B)<200_{HA}; C_D<2.0_{пФ};$	K1	K2	A1 A2
A3	MMBD4448	VISH	FID	$V_R<75B; I_F<500_{MA}; V_F(I_F=100_{MA})<1.0B; I_R<5.0_{мкA}; C_D<4_{пФ}; t_{RR}<4_{HC}$	A	nc	K
A3p	BAT17	PHIL	SHD	$V_R<4B; I_F<30_{MA}; V_F(I_F=1_{MA})<450_{MB}; C_D<1_{пФ};$	A	nc	K
A4	BAV70	ALLEG	2xD	$I_F<100_{MA}; V_{BR}>70; V_F(I_F=10_{MA})<0.86B; I_R<5000_{HA}; t_{RR}<6.0_{HC}; C_O<1_{пФ};$	A1	A2	K1 K2
A4	HSMS-2804	HP	2xSHD	$V_{BR}>70; V_F(I_F=15_{MA})<1.0B; I_R(V_R=50B)<200_{HA}; C_D<2.0_{пФ}$	A1	A2	K1 K2
A4	BAV70	VISH	2xDI	$V_R<70B; I_F<300_{MA}; V_F(I_F=150_{MA})<1.25B; I_R<5.0_{мкA}; C_D<4_{пФ}; t_{RR}<6_{HC}$	A1	A2	K1 K2
A4	BAV70	ZETEX	2xDI	$V_R<70B; I_F<100_{MA}; V_F(I_F=50_{MA})<1.1B; I_R<5.0_{мкA}; C_D<1.5_{пФ}; t_{RR}<6_{HC}$	A1	A2	K1 K2
A4p	BAV70	PHIL	2xFD	$V_R<70B; I_F<215_{MA}; V_F(I_F=50_{MA})<1.0B; C_D<1.5_{пФ}; t_{RR}<4_{HC}$	A1	A2	K1 K2
A4s	BAV70	SIEM	2xDI	$V_R<70B; I_F<200_{MA}; V_F(I_F=150_{MA})<1.25B; I_R<2.5_{мкA}; C_D<1.5_{пФ}; t_{RR}<6_{HC}$	A1	A2	K1 K2
A5	FMMD2837	ZETEX	2xFID	$V_R<35B; I_F<100_{MA}; V_F(I_F=50_{MA})<1.0B; I_R<0.1_{мкA}; C_D<4.0_{пФ}; t_{RR}<6_{HC}$	A1	A2	K1 K2
A6	BAS16	ALLEG	D	$I_F<600_{MA}; V_{BR}>75; V_F(I_F=1_{MA})<0.72B; I_R<1000_{HA}; t_{RR}<6.0_{HC}; C_O<2.0_{пФ};$	A	nc	K
A6	BAS16	VISH	FID	$V_R<75B; I_F<500_{MA}; V_F(I_F=150_{MA})<1.25B; I_R<1.0_{мкA}; C_D<4.0_{пФ}; t_{RR}<4_{HC}$	A	nc	K
A6	BAS16	ZETEX	DI	$V_R<75B; I_F<250_{MA}; V_F(I_F=50_{MA})<1.0B; I_R<1.0_{мкA}; C_D<2.0_{пФ}; t_{RR}<6_{HC}$	A	nc	K
A6p	BAS16	PHIL	FD	$V_R<75B; I_F<215_{MA}; V_F(I_F=50_{MA})<1.0B; C_D<1.5_{пФ}; t_{RR}<4_{HC}$	A	nc	K
A6s	BAS16	SIEM	DI	$V_R<75B; I_F<250_{MA}; V_F(I_F=50_{MA})<1.0B; I_R<1.0_{мкA}; C_D<2.0_{пФ}; t_{RR}<6_{HC}$	A	nc	K
A7	BAV99	ALLEG	2xD	$I_F<70_{MA}; V_{BR}>70; V_F(I_F=50_{MA})<1.1B; I_R<2500_{HA}; t_{RR}<6.0_{HC}; C_O<2.0_{пФ};$	A1	K2	K1 A2
A7	BAV99	VISH	2xDI	$V_R<70B; I_F<300_{MA}; V_F(I_F=150_{MA})<1.25B; I_R<5.0_{мкA}; C_D<4.0_{пФ}; t_{RR}<6_{HC}$	A1	K2	K1 A2
A7	BAV99	ZETEX	2xDI	$V_R<70B; I_F<100_{MA}; V_F(I_F=50_{MA})<1.1B; I_R<2.5_{мкA}; C_D<1.5_{пФ}; t_{RR}<6_{HC}$	A1	K2	K1 A2
A7p	BAV99	PHIL	2xFD	$V_R<75B; I_F<215_{MA}; V_F(I_F=50_{MA})<1.0B; C_D<1.5_{пФ}; t_{RR}<4_{HC}$	A1	K2	K1 A2

SOT23, SOD23 (продолжение)

Код	Типономинал	Фирма	Функция	Особенности	Цолевка		
					1	2	3
A7s	BAV99	SIEM	2xDI	$V_R < 70B$; $I_F < 200_{mA}$; $V_F(I_F = 150_{mA}) < 1.25B$; $I_R < 2.5_{мкA}$; $C_D < 1.5_{пФ}$; $t_{RR} < 6_{HC}$	A1	K2	K1 A2
A8	BAS19	ALLEG	D	$I_F < 200_{mA}$; $V_{BR} > 100$; $V_F(I_F = 200_{mA}) < 1.25B$; $I_R < 100_{HА}$; $t_{RR} < 50_{HC}$; $C_O < 5.0_{пФ}$;	A	nc	K
A8	BAS19	VISH	DI	$V_R < 100B$; $I_F < 400_{mA}$; $V_F(I_F = 200_{mA}) < 1.25B$; $I_R < 0.1_{мкA}$; $C_D < 5.0_{пФ}$; $t_{RR} < 50_{HC}$	A	nc	K
A8	BAS19	ZETEX	DI	$V_R < 100B$; $I_F < 200_{mA}$; $V_F(I_F = 100_{mA}) < 1.0B$; $I_R < 0.1_{мкA}$; $C_D < 5.0_{пФ}$; $t_{RR} < 50_{HC}$	A	nc	K
A81	BAS20	VISH	DI	$V_R < 150B$; $I_F < 400_{mA}$; $V_F(I_F = 200_{mA}) < 1.25B$; $I_R < 0.1_{мкA}$; $C_D < 5.0_{пФ}$; $t_{RR} < 50_{HC}$	A	nc	K
A81	BAS20	ZETEX	DI	$V_R < 150B$; $I_F < 200_{mA}$; $V_F(I_F = 100_{mA}) < 1.0B$; $I_R < 0.1_{мкA}$; $C_D < 5.0_{пФ}$; $t_{RR} < 50_{HC}$	A	nc	K
A82	BAS21	ALLEG	DI	$I_F < 200_{mA}$; $V_{BR} > 200$; $V_F(I_F = 100_{mA}) < 1.0B$; $I_R < 100_{HА}$; $t_{RR} < 50_{HC}$; $C_O < 5.0_{пФ}$;	A	nc	K
A82	CMPD2003	CENTS	DI	$I_F < 250_{mA}$; $V_{BR} > 200$; $V_F(I_F = 100_{mA}) < 1.0B$; $I_R < 100_{HА}$; $t_{RR} < 50_{HC}$; $C_T < 5.0_{пФ}$;	A	nc	K
A82	BAS21	VISH	DI	$V_R < 200B$; $I_F < 400_{mA}$; $V_F(I_F = 200_{mA}) < 1.25B$; $I_R < 0.1_{мкA}$; $C_D < 5.0_{пФ}$; $t_{RR} < 50_{HC}$	A	nc	K
A82	BAS21	ZETEX	DI	$V_R < 200B$; $I_F < 200_{mA}$; $V_F(I_F = 100_{mA}) < 1.0B$; $I_R < 0.1_{мкA}$; $C_D < 5.0_{пФ}$; $t_{RR} < 50_{HC}$	A	nc	K
A9	FMMD2835	ZETEX	2xFID	$V_R < 35B$; $I_F < 100_{mA}$; $V_F(I_F = 50_{mA}) < 1.0B$; $I_R < 0.1_{мкA}$; $C_D < 4.0_{пФ}$; $t_{RR} < 6_{HC}$	K1	K2	A1 A2
AA	BCW60A	ALLEG	NPN	$V_{CB0} = 32B$; $I_C < 20_{HА}$; $h_{21} = 120 \dots 220$; $V_{CE(sat)} < 0.35B$; $f_T > 125_{MГц}$	B	E	C
AA	BCW60A	CDIL	NPN	$V_{CB0} = 32B$; $I_C = 200_{HА}$; $P_D = 250_{мВт}$; $h_{21} = 120 \dots 220$; $f_T > 100_{MГц}$	B	E	C
AA	BCW60A	SAMS	NPN	$V_{CB0} = 32B$; $I_C = 100_{HА}$; $P_D = 350_{мВт}$; $h_{21} = 120 \dots 220$; $f_T > 125_{MГц}$	B	E	C
AA	BCW60A	ZETEX	NPN	$V_{CB0} = 32B$; $I_C = 200_{HА}$; $P_D = 330_{мВт}$; $h_{21} = 120 \dots 220$; $f_T > 250_{MГц}$	B	E	C
AAD	TMPD4448	ALLEG	D	$I_F < 600_{mA}$; $V_{BR} > 100$; $V_F(I_F = 100_{mA}) < 1.0B$; $I_R < 25_{HА}$; $t_{RR} < 4.0_{HC}$; $C_O < 4.0_{пФ}$;	A	nc	K
AAD	CMPD4448	CENTS	DIH	$I_F = 250_{mA}$; $V_R = 75B$; $V_F(I_F = 100_{mA}) < 1.0B$; $I_R < 25_{HА}$; $t_{RR} < 4.0_{HC}$; $C_T < 4.0_{пФ}$;	A	nc	K
AAG	MMBR951AL T1	MOT	NPN	$V_{CB0} = 20B$; $I_C = 100_{mA}$; $P_D = 322_{мВт}$; $h_{21} = 75 \dots 150$; $f_T = 8000_{MГц}$	B	E	C
AAp	BCW60A	PHIL	NPN	$V_{CB0} = 32B$; $I_C = 200_{mA}$; $P_D = 250_{мВт}$; $h_{21} = 120 \dots 220$; $f_T > 100_{MГц}$	B	E	C
AAR	TMPD4153	ALLEG	D	$I_F < 600_{mA}$; $V_{BR} > 75B$; $V_F(I_F = 1_{mA}) < 0.67B$; $I_R < 50_{HА}$; $t_{RR} < 4.0_{HC}$; $C_O < 4.0_{пФ}$;	A	nc	K
AAs	BCW60A	SIEM	NPN	$V_{CB0} = 32B$; $I_C = 100_{mA}$; $P_D = 330_{мВт}$; $h_{21} = 120 \dots 220$; $f_T = 250_{MГц}$	B	E	C
AB	BCW60B	ALLEG	NPN	$V_{CB0} = 32B$; $I_C < 20_{HА}$; $h_{21} = 180 \dots 310$; $V_{CE(sat)} < 0.35B$; $f_T > 125_{MГц}$	B	E	C
AB	BCW60B	CDIL	NPN	$V_{CB0} = 32B$; $I_C = 200_{mA}$; $P_D = 250_{мВт}$; $h_{21} = 180 \dots 320$; $f_T > 100_{MГц}$	B	E	C
AB	BCW60B	SAMS	NPN	$V_{CB0} = 32B$; $I_C = 100_{mA}$; $P_D = 350_{мВт}$; $h_{21} = 180 \dots 310$; $f_T > 125_{MГц}$	B	E	C
AB	BCW60B	ZETEX	NPN	$V_{CB0} = 32B$; $I_C = 200_{mA}$; $P_D = 330_{мВт}$; $h_{21} = 180 \dots 310$; $f_T > 250_{MГц}$	B	E	C
ABA	TMPD4150	ALLEG	D	$I_F < 600_{mA}$; $V_{BR} > 75B$; $V_F(I_F = 1_{mA}) < 0.62B$; $I_R < 100_{HА}$; $t_{RR} < 4.0_{HC}$; $C_O < 2.5_{пФ}$;	A	nc	K
ABA	CMPD4150	CENTS	DIH	$I_F = 250_{mA}$; $V_{BR} = 50B$; $V_F(I_F = 100_{mA}) < 0.82 \dots 0.92B$; $I_R < 100_{HА}$; $t_{RR} < 4.0_{HC}$; $C_T < 4.0_{пФ}$;	A	nc	K
ABC	TMPD4154	ALLEG	D	$I_F < 600_{mA}$; $V_{BR} > 35B$; $V_F(I_F = 30_{mA}) < 1.0B$; $I_R < 100_{HА}$; $t_{RR} < 4.0_{HC}$; $C_O < 4.0_{пФ}$;	A	nc	K
ABp	BCW60B	PHIL	NPN	$V_{CB0} = 32B$; $I_C = 200_{mA}$; $P_D = 250_{мВт}$; $h_{21} = 180 \dots 320$; $f_T > 100_{MГц}$	B	E	C
ABs	BCW60B	SIEM	NPN	$V_{CB0} = 32B$; $I_C = 100_{mA}$; $P_D = 330_{мВт}$; $h_{21} = 180 \dots 310$; $f_T = 250_{MГц}$	B	E	C
AC	BCW60C	ALLEG	NPN	$V_{CB0} = 32B$; $I_C < 20_{HА}$; $h_{21} = 250 \dots 460$; $V_{CE(sat)} < 0.35B$; $f_T > 125_{MГц}$	B	E	C
AC	BCW60C	CDIL	NPN	$V_{CB0} = 32B$; $I_C = 200_{mA}$; $P_D = 330_{мВт}$; $h_{21} = 250 \dots 460$; $f_T > 250_{MГц}$	B	E	C
AC	BCW60C	SAMS	NPN	$V_{CB0} = 32B$; $I_C = 100_{mA}$; $P_D = 350_{мВт}$; $h_{21} = 250 \dots 460$; $f_T > 125_{MГц}$	B	E	C
AC	BCW60C	ZETEX	NPN	$V_{CB0} = 32B$; $I_C = 200_{mA}$; $P_D = 330_{мВт}$; $h_{21} = 250 \dots 460$; $f_T > 250_{MГц}$	B	E	C
ACp	BCW60C	PHIL	NPN	$V_{CB0} = 32B$; $I_C = 200_{mA}$; $P_D = 250_{мВт}$; $h_{21} = 250 \dots 460$; $f_T > 100_{MГц}$	B	E	C

SOT23, SOD23 (продолжение)

Код	Типономинал	Фирма	Функция	Особенности	Цоколевка		
					1	2	3
ACs	BCW60C	SIEM	NPN	$V_{CB0}=32B; I_C=100mA; P_D=330mB; h_{21}=250...460; f_T=250MГц$	B	E	C
AD	BCW60D	ALLEG	NPN	$V_{CB0}=32B; I_{CB0}<20mA; h_{21}=380...630; V_{CE(sat)}<0.35B; f_T>125MГц$	B	E	C
AD	BCW60D	CDIL	NPN	$V_{CB0}=32B; I_C=100mA; P_D=350mB; h_{21}=380...630; f_T>125MГц$	B	E	C
AD	BCW60D	SAMS	NPN	$V_{CB0}=32B; I_C=100mA; P_D=350mB; h_{21}=380...630; f_T>125MГц$	B	E	C
AD	BCW60D	ZETEX	NPN	$V_{CB0}=32B; I_C=200mA; P_D=330mB; h_{21}=380...630; f_T>250MГц$	B	E	C
ADp	BCW60D	PHIL	NPN	$V_{CB0}=32B; I_C=200mA; P_D=250mB; h_{21}=380...630; f_T>100MГц$	B	E	C
ADs	BCW60D	SIEM	NPN	$V_{CB0}=32B; I_C=100mA; P_D=330mB; h_{21}=380...630; f_T=250MГц$	B	E	C
AFs	BCW60FF	SIEM	NPN	$V_{CB0}=32B; I_C=100mA; P_D=330mB; h_{21}=250...460; f_T=250MГц$	B	E	C
AG	BCX70G	ALLEG	NPN	$V_{CB0}=45B; I_{CB0}<20mA; h_{21}=120...220; V_{CE(sat)}<0.35B; f_T>125MГц$	B	E	C
AG	BCX70G	CDIL	NPN	$V_{CB0}=45B; I_C=200mA; P_D=250mB; h_{21}=120...220; f_T>100MГц$	B	E	C
AG	BCX70G	SAMS	NPN	$V_{CB0}=45B; I_C=200mA; P_D=350mB; h_{21}=120...220; f_T>125MГц$	B	E	C
AG	BCX70G	ZETEX	NPN	$V_{CB0}=45B; I_C=200mA; P_D=330mB; h_{21}=120...220; f_T>250MГц$	B	E	C
AGp	BCX70G	PHIL	NPN	$V_{CB0}=45B; I_C=200mA; P_D=250mB; h_{21}=120...220; f_T>100MГц$	B	E	C
AGs	BCX70G	SIEM	NPN	$V_{CB0}=45B; I_C=100mA; P_D=330mB; h_{21}=120...220; f_T=250MГц$	B	E	C
AH	BCX70H	ALLEG	NPN	$V_{CB0}=45B; I_{CB0}<20mA; h_{21}=180...310; V_{CE(sat)}<0.35B; f_T>125MГц$	B	E	C
AH	BCX70H	CDIL	NPN	$V_{CB0}=45B; I_C=200mA; P_D=250mB; h_{21}=250...460; f_T>100MГц$	B	E	C
AH	BCX70H	SAMS	NPN	$V_{CB0}=45B; I_C=200mA; P_D=350mB; h_{21}=180...310; f_T>125MГц$	B	E	C
AH	BCX70H	ZETEX	NPN	$V_{CB0}=45B; I_C=200mA; P_D=330mB; h_{21}=180...310; f_T>250MГц$	B	E	C
AHp	BCX70H	PHIL	NPN	$V_{CB0}=45B; I_C=200mA; P_D=250mB; h_{21}=250...460; f_T>100MГц$	B	E	C
AHs	BCX70H	SIEM	NPN	$V_{CB0}=45B; I_C=100mA; P_D=330mB; h_{21}=180...310; f_T=250MГц$	B	E	C
AJ	BCX70J	ALLEG	NPN	$V_{CB0}=45B; I_{CB0}<20mA; h_{21}=250...460; V_{CE(sat)}<0.35B; f_T>125MГц$	B	E	C
AJ	BCX70J	CDIL	NPN	$V_{CB0}=45B; I_C=100mA; P_D=330mB; h_{21}=250...460; f_T>250MГц$	B	E	C
AJ	BCX70J	SAMS	NPN	$V_{CB0}=45B; I_C=200mA; P_D=350mB; h_{21}=250...460; f_T>125MГц$	B	E	C
AJ	BCX70J	ZETEX	NPN	$V_{CB0}=45B; I_C=200mA; P_D=330mB; h_{21}=250...460; f_T>250MГц$	B	E	C
AJp	BCX70J	PHIL	NPN	$V_{CB0}=45B; I_C=200mA; P_D=250mB; h_{21}=180...310; f_T>100MГц$	B	E	C
AJs	BCX70J	SIEM	NPN	$V_{CB0}=45B; I_C=100mA; P_D=330mB; h_{21}=250...460; f_T=250MГц$	B	E	C
AK	BCX70K	ALLEG	NPN	$V_{CB0}=45B; I_{CB0}<20mA; h_{21}=380...630; V_{CE(sat)}<0.35B; f_T>125MГц$	B	E	C
AK	BCX70K	CDIL	NPN	$V_{CB0}=45B; I_C=200mA; P_D=250mB; h_{21}=380...630; f_T>100MГц$	B	E	C
AK	BCX70K	SAMS	NPN	$V_{CB0}=45B; I_C=200mA; P_D=350mB; h_{21}=380...630; f_T>125MГц$	B	E	C
AK	BCX70K	ZETEX	NPN	$V_{CB0}=45B; I_C=200mA; P_D=330mB; h_{21}=380...630; f_T>250MГц$	B	E	C
Akp	BCX70K	PHIL	NPN	$V_{CB0}=45B; I_C=200mA; P_D=250mB; h_{21}=380...630; f_T>100MГц$	B	E	C
AKs	BCX70K	SIEM	NPN	$V_{CB0}=45B; I_C=100mA; P_D=330mB; h_{21}=380...630; f_T=250MГц$	B	E	C
AMp	BSS64	PHIL	NPN	$V_{CB0}=120B; I_C=100mA; P_D=250mB; h_{21}>20; f_T>60$	B	E	C
AMs	BSS64	SIEM	NPN	$V_{CB0}=120B; I_C=800mA; P_D=330mB; h_{21}=20...80; f_T=100MГц$	B	E	C
ANs	BCW60FN	SIEM	NPN	$V_{CB0}=32B; I_C=100mA; P_D=330mB; h_{21}=380...630; f_T=250MГц$	B	E	C
AR	BCW60CR	ZETEX	NPN	$V_{CB0}=32B; I_C=200mA; P_D=330mB; h_{21}=250...460; f_T>250MГц$	B	E	C

SOT23, SOD23 (продолжение)

Код	Типономинал	Фирма	Функция	Особенности	Цоколевка		
					1	2	3
AS	BAT18-05	SIEM	2хСРIN	$V_{R<35B}$; $I_{F<100mA}$; $V_{F(I_F=100mA)}<1.2B$; $I_{R<0.02мкА}$; $C_D<1.0пФ$;	A1	A2	K1 K2
ASG	KTA1504	KEC	PNP	$V_{CB0}=-50B$; $I_C=-150mA$; $P_D=150мВт$; $h_{21}=200...400$; $f_T>80MГц$	B	E	C
ASO	KTA1504	KEC	PNP	$V_{CB0}=-50B$; $I_C=-150mA$; $P_D=150мВт$; $h_{21}=70...140$; $f_T>80MГц$	B	E	C
ASY	KTA1504	KEC	PNP	$V_{CB0}=-50B$; $I_C=-150mA$; $P_D=150мВт$; $h_{21}=120...240$; $f_T>80MГц$	B	E	C
AT	BAT18-06	SIEM	2хСРIN	$V_{R<35B}$; $I_{F<100mA}$; $V_{F(I_F=100mA)}<1.2B$; $I_{R<0.02мкА}$; $C_D<1.0пФ$;	K1	K2	A1 A2
AU	BAT18-04	SIEM	2хСРIN	$V_{R<35B}$; $I_{F<100mA}$; $V_{F(I_F=100mA)}<1.2B$; $I_{R<0.02мкА}$; $C_D<1.0пФ$;	A1	K2	K1 A2
AW	BCX70GR	ZETEX	NPN	$V_{CB0}=45B$; $I_C=200mA$; $P_D=330мВт$; $h_{21}=120...220$; $f_T>250MГц$	B	E	C
AX	BCX70JR	ZETEX	NPN	$V_{CB0}=45B$; $I_C=200mA$; $P_D=330мВт$; $h_{21}=250...460$; $f_T>250MГц$	B	E	C
AZO	KTA1505	KEC	PNP	$V_{CB0}=-35B$; $I_C=-500mA$; $P_D=150мВт$; $h_{21}=70...140$; $f_T>200MГц$	B	E	C
AZY	KTA1505	KEC	PNP	$V_{CB0}=-35B$; $I_C=-500mA$; $P_D=150мВт$; $h_{21}=120...240$; $f_T>200MГц$	B	E	C
B0	HSMS-2810	HP	SHD	$V_{BR}<20B$; $V_{F(I_F=35mA)}<1.0B$; $I_{R(V_R=15B)}<200μА$; $C_D<1.2пФ$;	A	nc	K
B0	SST5460	SIL	pFET	$V_{DS}=-40B$; $P_D=350мВт$; $I_{DSS}=1...5mA$; $g_F=1мСм$	D	S	G
B1	SST5461	SIL	pFET	$V_{DS}=-40B$; $P_D=350мВт$; $I_{DSS}=2...9mA$; $g_F=1.5мСм$	D	S	G
B10	KSC2715	SAMS	NPN	$V_{CB0}=35B$; $I_C=50mA$; $P_D=150мВт$; $h_{21}=70...140$; $f_T>150MГц$	B	E	C
B1R	KSC2715	SAMS	NPN	$V_{CB0}=35B$; $I_C=50mA$; $P_D=150мВт$; $h_{21}=40...80$; $f_T>150MГц$	B	E	C
B1Y	KSC2715	SAMS	NPN	$V_{CB0}=35B$; $I_C=50mA$; $P_D=150мВт$; $h_{21}=120...240$; $f_T>150MГц$	B	E	C
B2	HSMS-2812	HP	2хSHD	$V_{BR}>20B$; $V_{F(I_F=35mA)}<1.0B$; $I_{R(V_R=15B)}<200μА$; $C_D<1.2пФ$;	A1	K2	K1 A2
B2	BSV52LT1	MOT	NPN	$V_{CB0}=20B$; $I_C=100mA$; $P_D=300мВт$; $h_{21}=40...120$; $f_T>400MГц$	B	E	C
B2	SST5462	SIL	pFET	$V_{DS}=-40B$; $P_D=350мВт$; $I_{DSS}=4...16mA$; $g_F=2мСм$	D	S	G
B2	BSV52	ZETEX	NPN	$V_{CB0}=20B$; $I_C=100mA$; $P_D=300мВт$; $h_{21}=40...120$; $f_T>500MГц$	B	E	C
B26	BF570	PHIL	NPN	$V_{CB0}=40B$; $I_C=100mA$; $P_D=250мВт$; $h_{21}>40$; $f_T>490MГц$	B	E	C
B2p	BSV52	PHIL	NPN	$V_{CB0}=20B$; $I_C=100mA$; $P_D=250мВт$; $h_{21}=40...120$; $f_T>400MГц$	B	E	C
B3	HSMS-2813	HP	2хSHD	$V_{BR}>20B$; $V_{F(I_F=35mA)}<1.0B$; $I_{R(V_R=15B)}<200μА$; $C_D<1.2пФ$;	K1	K2	A1 A2
B31	IDB31	GS	BTD	$V_{B0}=20...34B$; $I_{TRM}=2A$; $P_D=150мВт$	x	x	n.c
B4	HSMS-2814	HP	2хSHD	$V_{BR}>20B$; $V_{F(I_F=35mA)}<1.0B$; $I_{R(V_R=15B)}<200μА$; $C_D<1.2пФ$;	A1	A2	K1 K2
B4	BSV52R	PHIL	NPN	$V_{CB0}=12B$; $I_C=200mA$; $P_D=250мВт$; $h_{21}=40$; $f_T>400MГц$	K1	K2	A1 A2
B4	BSV52R	ZETEX	NPN	$V_{CB0}=20B$; $I_C=100mA$; $P_D=330мВт$; $h_{21}=40...120$; $f_T>500MГц$	B	E	C
BA	BCW61A	ALLEG	PNP	$V_{CB0}=-32B$; $I_{CB0}<20μА$; $h_{21}=120...220$; $V_{CE(sat)}<0.25B$	B	E	C
BA	BCW61A	CDIL	PNP	$V_{CB0}=-32B$; $I_C=-200mA$; $P_D=330мВт$; $h_{21}=120...220$; $f_T>180MГц$	B	E	C
BA	BCW61A	SAMS	PNP	$V_{CB0}=-32B$; $I_C=-200mA$; $P_D=350мВт$; $h_{21}=120...220$	B	E	C
BA	BCW61A	ZETEX	PNP	$V_{CB0}=-32B$; $I_C=-200mA$; $P_D=330мВт$; $h_{21}=120...220$; $f_T>180MГц$	B	E	C
BAp	BCW61A	PHIL	PNP	$V_{CB0}=-32B$; $I_C=-200mA$; $P_D=250мВт$; $h_{21}=120...220$; $f_T>100MГц$	B	E	C
BAs	BCW61A	SIEM	PNP	$V_{CB0}=-32B$; $I_C=-200mA$; $P_D=330мВт$; $h_{21}=120...220$; $f_T=250MГц$	B	E	C
BB	BCW61B	ALLEG	PNP	$V_{CB0}=-32B$; $I_{CB0}<20μА$; $h_{21}=180...310$; $V_{CE(sat)}<0.25B$	B	E	C
BB	BCW61B	CDIL	PNP	$V_{CB0}=-32B$; $I_C=-200mA$; $P_D=330мВт$; $h_{21}=180...310$; $f_T>180MГц$	B	E	C
BB	BCW61B	SAMS	PNP	$V_{CB0}=-32B$; $I_C=-100mA$; $P_D=350мВт$; $h_{21}=180...310$	B	E	C
BB	BCW61B	ZETEX	PNP	$V_{CB0}=-32B$; $I_C=-200mA$; $P_D=330мВт$; $h_{21}=180...310$; $f_T>180MГц$	B	E	C
BBp	BCW61B	PHIL	PNP	$V_{CB0}=-32B$; $I_C=-200mA$; $P_D=250мВт$; $h_{21}=180...310$; $f_T>100MГц$	B	E	C
BBs	BCW61B	SIEM	PNP	$V_{CB0}=-32B$; $I_C=-100mA$; $P_D=330мВт$; $h_{21}=180...310$; $f_T=250MГц$	B	E	C
BC	BCW61C	ALLEG	PNP	$V_{CB0}=-32B$; $I_{CB0}<20μА$; $h_{21}=250...460$; $V_{CE(sat)}<0.25B$	B	E	C

SOT23, SOD23 (продолжение)

Код	Типономинал	Фирма	Функция	Особенности	Цоколевка		
					1	2	3
BC	BCW61C	CDIL	PNP	$V_{CB0}=-32В; I_{C}=-200_{MA}; P_D=330мВт; h_{21}=250...460; f_T>180МГц$	B	E	C
BC	BCW61C	SAMS	PNP	$V_{CB0}=-32В; I_{C}=-100_{MA}; P_D=350мВт; h_{21}=250...460; f_T>125МГц$	B	E	C
BC	BCW61C	ZETEX	PNP	$V_{CB0}=-32В; I_{C}=-200_{MA}; P_D=330мВт; h_{21}=250...460; f_T>180МГц$	B	E	C
BCp	BCW61C	PHIL	PNP	$V_{CB0}=-32В; I_{C}=-200_{MA}; P_D=250мВт; h_{21}=250...460; f_T>100МГц$	B	E	C
BCs	BCW61C	SIEM	PNP	$V_{CB0}=-32В; I_{C}=-100_{MA}; P_D=330мВт; h_{21}=250...460; f_T=250МГц$	B	E	C
BD	BCW61D	ALLEG	PNP	$V_{CB0}=-32В; I_{CB0}<20_{HA}; h_{21}=380...630; V_{CE(sat)}<0.25В$	B	E	C
BD	BCW61D	CDIL	PNP	$V_{CB0}=-32В; I_{C}=-200_{MA}; P_D=330мВт; h_{21}=380...630; f_T>180МГц$	B	E	C
BD	BCW61D	SAMS	PNP	$V_{CB0}=-32В; I_{C}=-100_{MA}; P_D=350мВт; h_{21}=380...630; f_T>125МГц$	B	E	C
BD	BCW61D	ZETEX	PNP	$V_{CB0}=-32В; I_{C}=-200_{MA}; P_D=330мВт; h_{21}=380...630; f_T>180МГц$	B	E	C
BDp	BCW61D	PHIL	PNP	$V_{CB0}=-32В; I_{C}=-200_{MA}; P_D=250мВт; h_{21}=380...630; f_T>100МГц$	B	E	C
BDs	BCW61D	SIEM	PNP	$V_{CB0}=-32В; I_{C}=-100_{MA}; P_D=330мВт; h_{21}=380...630; f_T=250МГц$	B	E	C
BFs	BCW61FF	SIEM	PNP	$V_{CB0}=-32В; I_{C}=-100_{MA}; P_D=330мВт; h_{21}=250...460; f_T=250МГц$	B	E	C
BG	BCW61G	ALLEG	PNP	$V_{CB0}=-32В; I_{CB0}<20_{HA}; h_{21}=120...220; V_{CE(sat)}<0.25В$	B	E	C
BG	BCW61G	CDIL	PNP	$V_{CB0}=-45В; I_{C}=-200_{MA}; P_D=250мВт; h_{21}=120...220; f_T>100МГц$	B	E	C
BG	BCW61G	SAMS	PNP	$V_{CB0}=-45В; I_{C}=-100_{MA}; P_D=350мВт; h_{21}=120...220$	B	E	C
BG	BCW61G	ZETEX	PNP	$V_{CB0}=-45В; I_{C}=-200_{MA}; P_D=330мВт; h_{21}=120...220; f_T>180МГц$	B	E	C
BGp	BCW61G	PHIL	PNP	$V_{CB0}=-45В; I_{C}=-200_{MA}; P_D=250мВт; h_{21}=120...220; f_T>100МГц$	B	E	C
BGs	BCW61G	SIEM	PNP	$V_{CB0}=-45В; I_{C}=-100_{MA}; P_D=330мВт; h_{21}=120...220; f_T=250МГц$	B	E	C
BH	BCX71H	ALLEG	PNP	$V_{CB0}=-45В; I_{CB0}<20_{HA}; h_{21}=180...310; V_{CE(sat)}<0.25В$	B	E	C
BH	BCX71H	CDIL	PNP	$V_{CB0}=-45В; I_{C}=-200_{MA}; P_D=250мВт; h_{21}=180...310; f_T>100МГц$	B	E	C
BH	BCX71H	SAMS	PNP	$V_{CB0}=-45В; I_{C}=-100_{MA}; P_D=350мВт; h_{21}=140...310$	B	E	C
BH	BCX71H	ZETEX	PNP	$V_{CB0}=-45В; I_{C}=-200_{MA}; P_D=330мВт; h_{21}=180...310; f_T>180МГц$	B	E	C
BHp	BCX71H	PHIL	PNP	$V_{CB0}=-45В; I_{C}=-200_{MA}; P_D=250мВт; h_{21}=180...310; f_T>100МГц$	B	E	C
BHs	BCX71H	SIEM	PNP	$V_{CB0}=-45В; I_{C}=-100_{MA}; P_D=330мВт; h_{21}=180...310; f_T=250МГц$	B	E	C
BJ	BCX71J	ALLEG	PNP	$V_{CB0}=-45В; I_{CB0}<20_{HA}; h_{21}=250...460; V_{CE(sat)}<0.25В$	B	E	C
BJ	BCX71J	CDIL	PNP	$V_{CB0}=-45В; I_{C}=-200_{MA}; P_D=250мВт; h_{21}=250...460; f_T>100МГц$	B	E	C
BJ	BCX71J	SAMS	PNP	$V_{CB0}=-45В; I_{C}=-100_{MA}; P_D=350мВт; h_{21}=250...460$	B	E	C
BJ	BCX71J	ZETEX	PNP	$V_{CB0}=-45В; I_{C}=-200_{MA}; P_D=330мВт; h_{21}=250...460; f_T>180МГц$	B	E	C
BJp	BCX71J	PHIL	PNP	$V_{CB0}=-45В; I_{C}=-200_{MA}; P_D=250мВт; h_{21}=250...460; f_T>100МГц$	B	E	C
BJs	BCX71J	SIEM	PNP	$V_{CB0}=-45В; I_{C}=-100_{MA}; P_D=330мВт; h_{21}=250...460; f_T=250МГц$	B	E	C
BK	BCX71K	ALLEG	PNP	$V_{CB0}=-45В; I_{CB0}<20_{HA}; h_{21}=380...630; V_{CE(sat)}<0.25В$	B	E	C
BK	BCX71K	CDIL	PNP	$V_{CB0}=-45В; I_{C}=-200_{MA}; P_D=250мВт; h_{21}=380...630; f_T>100МГц$	B	E	C
BK	BCX71K	SAMS	PNP	$V_{CB0}=-45В; I_{C}=-100_{MA}; P_D=350мВт; h_{21}=380...630$	B	E	C
BK	BCX71K	ZETEX	PNP	$V_{CB0}=-45В; I_{C}=-200_{MA}; P_D=330мВт; h_{21}=380...630; f_T>180МГц$	B	E	C
BKp	BCX71K	PHIL	PNP	$V_{CB0}=-45В; I_{C}=-200_{MA}; P_D=250мВт; h_{21}=380...630; f_T>100МГц$	B	E	C
BKs	BCX71K	SIEM	PNP	$V_{CB0}=-45В; I_{C}=-100_{MA}; P_D=330мВт; h_{21}=380...630; f_T=250МГц$	B	E	C
BMp	BSS63	PHIL	PNP	$V_{CB0}=-110В; I_{C}=-100_{MA}; P_D=250мВт; h_{21}>30; f_T>50МГц$	B	E	C
BMs	BSS63	SIEM	PNP	$V_{CB0}=-100В; I_{C}=-800_{MA}; P_D=330мВт; h_{21}>30; f_T=150МГц$	B	E	C
BNs	BCW61FN	SIEM	PNP	$V_{CB0}=-32В; I_{C}=-100_{MA}; P_D=330мВт; h_{21}=380...630; f_T=250МГц$	B	E	C
BR	BCW60DR	ZETEX	NPN	$V_{CB0}=32В; I_{C}=200_{MA}; P_D=330мВт; h_{21}=380...630; f_T>250МГц$	B	E	C
C0	HSMS-2820	HP	SHD	$V_{BR}>15В; V_F(I_F=30_{MA})<0.7В; I_R(V_R=1В)<100_{HA}; C_D<1.0пФ;$	A	nc	K
C1	BCW29	ALLEG	PNP	$V_{CB0}=-30В; I_{CB0}<100_{HA}; h_{21}=120...260; V_{CE(sat)}<0.3В$	B	E	C

SOT23, SOD23 (продолжение)

Код	Типономинал	Фирма	Функция	Особенности	Цоколевка		
					1	2	3
C1	BCW29	CDIL	PNP	$V_{CB0}=-30B; I_C=-100mA; P_D=330mBT; h_{21}=120...260; f_T>150MГц$	B	E	C
C1	BCW29	SAMS	PNP	$V_{CB0}=-30B; I_C=-100mA; P_D=350mBT; h_{21}=120...260$	B	E	C
C1	BCW29	ZETEX	PNP	$V_{CB0}=-30B; I_C=-100mA; P_D=330mBT; h_{21}=120...260; f_T>150MГц$	B	E	C
C1A	CMPT3904	CENTS	NPN	$V_{CB0}=60B; I_C=200mA; P_D=350mBT; h_{21}=100...300; f_T>300MГц$	B	E	C
C1D	CMPTA42	CENTS	NPN	$V_{CB0}=300B; I_C=500mA; P_D=350mBT; h_{21}>40; f_T>50MГц$	B	E	C
C1G	CMPTA06	CENTS	NPN	$V_{CB0}=80B; I_C=500mA; P_D=350mBT; h_{21}>50; f_T>100MГц$	B	E	C
C1G	KSA1623	SAMS	NPN	$V_{CB0}=60B; I_C=100mA; P_D=200mBT; h_{21}=200...400; f_T>250MГц$	B	E	C
C1J	CMPT2369	CENTS	NPN	$V_{CB0}=40B; I_C=500mA; P_D=350mBT; h_{21}=40...120; f_T>500MГц$	B	E	C
C1K	CMPT6428	CENTS	NPN	$V_{CB0}=60B; I_C=200mA; P_D=350mBT; h_{21}=250...650; f_T=100...700MГц$	B	E	C
C1L	CMPT6429	CENTS	NPN	$V_{CB0}=55B; I_C=200mA; P_D=350mBT; h_{21}=500...1250; f_T=100...700MГц$	B	E	C
C1L	KSA1623	SAMS	NPN	$V_{CB0}=60B; I_C=100mA; P_D=200mBT; h_{21}=300...600; f_T>250MГц$	B	E	C
C1M	CMPTA13	CENTS	NPN	$V_{CB0}=30B; I_C=500mA; P_D=350mBT; h_{21}>5000; f_T>125MГц$	B	E	C
C1N	CMPTA14	CENTS	NPN	$V_{CB0}=30B; I_C=500mA; P_D=350mBT; h_{21}>10000; f_T>125MГц$	B	E	C
C10	KSA1623	SAMS	NPN	$V_{CB0}=60B; I_C=100mA; P_D=200mBT; h_{21}=90...180; f_T>250MГц$	B	E	C
C1P	CMPT2222A	CENTS	NPN	$V_{CB0}=75B; I_C=600mA; P_D=350mBT; h_{21}>35; f_T>300MГц$	B	E	C
C1p	BCW29	PHIL	PNP	$V_{CB0}=-32B; I_C=-100mA; P_D=250mBT; h_{21}=120...260; f_T>100MГц$	B	E	C
C1Q	CMPT5088	CENTS	NPN	$V_{CB0}=35B; I_C=50mA; P_D=350mBT; h_{21}=300...900; f_T>50MГц$	B	E	C
C1R	CMPT5089	CENTS	NPN	$V_{CB0}=30B; I_C=50mA; P_D=350mBT; h_{21}=400...1200; f_T>50MГц$	B	E	C
C1U	CMPT2484	CENTS	NPN	$V_{CB0}=60B; I_C=50mA; P_D=350mBT; h_{21}=250...800$	B	E	C
C1V	CMPT6427	CENTS	NPN	$V_{CB0}=40B; I_C=500mA; P_D=350mBT; h_{21}=10k...100k; f_T>130MГц$	B	E	C
C1X	CMPT930	CENTS	NPN	$V_{CB0}=45B; I_C=30mA; P_D=350mBT; h_{21}=100...300; f_T>30MГц$	B	E	C
C1Y	KSA1623	SAMS	NPN	$V_{CB0}=60B; I_C=100mA; P_D=200mBT; h_{21}=135...270; f_T>250MГц$	B	E	C
C1Z	CMPT6517	CENTS	NPN	$V_{CB0}=350B; I_C=500mA; P_D=350mBT; h_{21}=20...200; f_T=40...200MГц$	B	E	C
C2	BCW30	ALLEG	PNP	$V_{CB0}=-30B; I_{CB0}<100HA; h_{21}=215...500; V_{CE(sat)}<0.3B$	B	E	C
C2	BCW30	CDIL	PNP	$V_{CB0}=-30B; I_C=-100mA; P_D=330mBT; h_{21}=215...500; f_T>150MГц$	B	E	C
C2	HSMS-2822	HP	2xSHD	$V_{BR}>15B; V_F(I_F=30mA)<0.7B; I_R(V_R=1B)<100HA; C_D<1.0пФ;$	A1	K2	K1 A2
C2	BCW30	ZETEX	PNP	$V_{CB0}=-30B; I_C=-100mA; P_D=330mBT; h_{21}=215...500; f_T>150MГц$	B	E	C
C29	CMPTA29	CENTS	NPN	$V_{CB0}=100B; I_C=500mA; P_D=350mBT; h_{21}>10000; f_T>125MГц$	B	E	C
C2A	CMPT3906	CENTS	PNP	$V_{CB0}=-40B; I_C=-200mA; P_D=350mBT; h_{21}=100...300; f_T>250MГц$	B	E	C
C2A	ZDC833A	ZETEX	2xBD	$V_R<25B; C_{2V}=29.7...33.6пФ; C_{2V}/C_{20V}=5...6.5; Q>200$	A1	A2	K1 K2
C2D	CMPTA92	CENTS	PNP	$V_{CB0}=-300B; I_C=-500mA; P_D=350mBT; h_{21}>25; f_T>50MГц$	B	E	C
C2F	CMPT2907A	CENTS	PNP	$V_{CB0}=-60B; I_C=-600mA; P_D=350mBT; h_{21}=100...300; f_T>200MГц$	B	E	C
C2G	CMPTA56	CENTS	PNP	$V_{CB0}=800B; I_C=-500mA; P_D=350mBT; h_{21}>50; f_T>100MГц$	B	E	C
C2J	CMPT3640	CENTS	PNP	$V_{CB0}=-12B; I_C=-80mA; P_D=350mBT; h_{21}=30...120; f_T>500MГц$	B	E	C
C2L	CMPT5401	CENTS	PNP	$V_{CB0}=-160B; I_C=-500mA; P_D=350mBT; h_{21}=60...240; f_T=100...300MГц$	B	E	C
C2P	CMPT5086	CENTS	PNP	$V_{CB0}=-50B; I_C=-50mA; P_D=350mBT; h_{21}=150...500; f_T>40MГц$	B	E	C
C2p	BCW30	PHIL	PNP	$V_{CB0}=-32B; I_C=-100mA; P_D=250mBT; h_{21}=215...500; f_T>100MГц$	B	E	C
C2Q	CMPT5087	CENTS	PNP	$V_{CB0}=-50B; I_C=-50mA; P_D=350mBT; h_{21}=250...800; f_T>40MГц$	B	E	C
C2R	CMPT3646	CENTS	NPN	$V_{CB0}=40B; I_C=200mA; P_D=350mBT; h_{21}=30...120; f_T>350MГц$	B	E	C
C2T	CMPT4403	CENTS	PNP	$V_{CB0}=-40B; I_C=-600mA; P_D=250mBT; h_{21}=100...300; f_T>200MГц$	B	E	C
C2U	CMPTA63	CENTS	PNP	$V_{CB0}=-30B; I_C=-500mA; P_D=350mBT; h_{21}>10000; f_T>125MГц$	B	E	C

SOT23, SOD23 (продолжение)

Код	Типоминал	Фирма	Функция	Особенности	Цоколевка		
					1	2	3
C2V	CMPTA64	CENTS	PNP	$V_{CB0}=-30B; I_C=-500mA; P_D=350mBт; h_{21}>20000; f_T>125MГц$	B	E	C
C2W	CMPT8599	CENTS	PNP	$V_{CB0}=-80B; I_C=-500mA; P_D=350mBт; h_{21}=100...300; f_T>150MГц$	B	E	C
C2X	CMPT4401	CENTS	NPN	$V_{CB0}=60B; I_C=600mA; P_D=350mBт; h_{21}=100...300; f_T>250MГц$	B	E	C
C2Z	CMPT6520	CENTS	PNP	$V_{CB0}=-350B; I_C=-500mA; P_D=350mBт; h_{21}=20...200; f_T=40...200MГц$	B	E	C
C3	HSMS-2823	HP	2xSHD	$V_{BR}>15B; V_F(I_F=30mA)<0.7B; I_R(V_R=1B)<100HA; C_D<1.0пФ;$	K1	K2	A1 A2
C3	KST4126	SAMS	PNP	$V_{CB0}=-25B; I_C=-200mA; P_D=350mBт; h_{21}=120...360; f_T>250MГц$	B	E	C
C3A	CMPT3019	CENTS	NPN	$V_{CB0}=120B; I_C=500mA; P_D=350mBт; h_{21}=100...300; f_T>100MГц$	B	E	C
C3B	CMPT918	CENTS	NPN	$V_{CB0}=30B; I_C=50mA; P_D=350mBт; h_{21}>20; f_T>600MГц$	B	E	C
C3E	CMPTH10	CENTS	NPN	$V_{CB0}=30B; P_D=350mBт; h_{21}>60; f_T>650MГц$	B	E	C
C3Z	CMPTA44	CENTS	NPN	$V_{CB0}=450B; I_C=300mA; P_D=350mBт; h_{21}=50...200; f_T>20MГц$	B	E	C
C4	HSMS-2824	HP	2xSHD	$V_{BR}>15B; V_F(I_F=30mA)<0.7B; I_R(V_R=1B)<100HA; C_D<1.0пФ;$	A1	A2	K1 K2
C4	BCW29R	PHIL	PNP	$V_{CB0}=-32B; I_C=-100mA; P_D=350mBт; h_{21}=120...260; f_T>100MГц$	B	E	C
C4	BCW29R	ZETEX	PNP	$V_{CB0}=-30B; I_C=-100mA; P_D=350mBт; h_{21}=120...260; f_T>150MГц$	E	B	C
C4A	CMPT4033	CENTS	PNP	$V_{CB0}=-80B; I_C=-500mA; P_D=350mBт; h_{21}=100...300; f_T>100MГц$	B	E	C
C5	BCW30R	PHIL	PNP	$V_{CB0}=-20B; I_C=-100mA; P_D=350mBт; h_{21}=215...500; f_T>100MГц$	B	E	C
C5	BCW30R	ZETEX	PNP	$V_{CB0}=-30B; I_C=-100mA; P_D=330mBт; h_{21}=215...500; f_T>150MГц$	B	E	C
C5C	CMPD7000	CENTS	2xFID	$I_0=200mA; V_{RRM}=100B; V_F(I_F=100mA)=0.75...1.10B; I_R<300HA; t_{RR}<4.0нс; C_T<4.0пФ$	A2	K1	K2 A1
C5D	CMPD914	CENTS	FID	$I_F=250mA; V_R=75B; V_F(I_F=10mA)=1.0B; I_R<25HA; t_{RR}<4.0нс; C_T<4.0пФ$	A	nc	K
C77	BCF29R	PHIL	PNP	$V_{CB0}=-32B; I_C=-100mA; P_D=350mBт; h_{21}=120...260; f_T>100MГц$	E	B	C
C7H	CMPT5179	CENTS	NPN	$V_{CB0}=20B; P_D=500mBт; P_D=350mBт; h_{21}>25; f_T>900MГц$	B	E	C
C7p	BCF29	PHIL	PNP	$V_{CB0}=-32B; I_C=-100mA; P_D=250mBт; h_{21}=120...260; f_T>100MГц$	B	E	C
C8A	CMPZ5226B	CENTS	DZ	$V_Z(I_{ZT}=20mA)=3.135...3.465B; I_L(V_R=1.0B)<25mA; Z_{ZT}(I_{ZT}=20mA)<28OM$	A	nc	K
C8B	CMPZ5227B	CENTS	DZ	$V_Z(I_{ZT}=20mA)=3.42...3.78B; I_L(V_R=1.0B)<15mA; Z_{ZT}(I_{ZT}=20mA)<24OM$	A	nc	K
C8C	CMPZ5228B	CENTS	DZ	$V_Z(I_{ZT}=20mA)=3.705...4.095B; I_L(V_R=1.0B)<10mA; Z_{ZT}(I_{ZT}=20mA)<23OM$	A	nc	K
C8D	CMPZ5229B	CENTS	DZ	$V_Z(I_{ZT}=20mA)=4.085...4.515B; I_L(V_R=1.0B)<5.0mA; Z_{ZT}(I_{ZT}=20mA)<22OM$	A	nc	K
C8E	CMPZ5230B	CENTS	DZ	$V_Z(I_{ZT}=20mA)=4.465...4.935B; I_L(V_R=2.0B)<5.0mA; Z_{ZT}(I_{ZT}=20mA)<19OM$	A	nc	K
C8F	CMPZ5231B	CENTS	DZ	$V_Z(I_{ZT}=20mA)=4.845...5.355B; I_L(V_R=2.0B)<5.0mA; Z_{ZT}(I_{ZT}=20mA)<17OM$	A	nc	K
C8G	CMPZ5232B	CENTS	DZ	$V_Z(I_{ZT}=20mA)=5.320...5.880B; I_L(V_R=3.0B)<5.0mA; Z_{ZT}(I_{ZT}=20mA)<11OM$	A	nc	K
C8H	CMPZ5233B	CENTS	DZ	$V_Z(I_{ZT}=20mA)=5.700...6.300B; I_L(V_R=3.5B)<5.0mA; Z_{ZT}(I_{ZT}=20mA)<7.0OM$	A	nc	K
C8J	CMPZ5234B	CENTS	DZ	$V_Z(I_{ZT}=20mA)=5.890...6.510B; I_L(V_R=4.0B)<5.0mA; Z_{ZT}(I_{ZT}=20mA)<7.0OM$	A	nc	K
C8K	CMPZ5235B	CENTS	DZ	$V_Z(I_{ZT}=20mA)=6.460...7.140B; I_L(V_R=5.0B)<3.0mA; Z_{ZT}(I_{ZT}=20mA)<5.0OM$	A	nc	K
C8L	CMPZ5236B	CENTS	DZ	$V_Z(I_{ZT}=20mA)=7.125...7.875B; I_L(V_R=6.0B)<3.0mA; Z_{ZT}(I_{ZT}=20mA)<6.0OM$	A	nc	K
C8M	CMPZ5237B	CENTS	DZ	$V_Z(I_{ZT}=20mA)=7.790...8.610B; I_L(V_R=6.5B)<3.0mA; Z_{ZT}(I_{ZT}=20mA)<8.0OM$	A	nc	K
C8N	CMPZ5238B	CENTS	DZ	$V_Z(I_{ZT}=20mA)=8.265...9.135B; I_L(V_R=6.5B)<3.0mA; Z_{ZT}(I_{ZT}=20mA)<8.0OM$	A	nc	K
C8P	CMPZ5239B	CENTS	DZ	$V_Z(I_{ZT}=20mA)=8.645...9.555B; I_L(V_R=6.5B)<3.0mA; Z_{ZT}(I_{ZT}=20mA)<10OM$	A	nc	K
C8p	BCF30	PHIL	PNP	$V_{CB0}=-32B; I_C=-100mA; P_D=250mBт; h_{21}=215...500; f_T>100MГц$	B	E	C
C8Q	CMPZ5240B	CENTS	DZ	$V_Z(I_{ZT}=20mA)=9.500...10.50B; I_L(V_R=8.0B)<3.0mA; Z_{ZT}(I_{ZT}=20mA)<17OM$	A	nc	K

SOT23, SOD23 (продолжение)

Код	Типономинал	Фирма	Функция	Особенности	Цоколевка		
					1	2	3
C8R	CMPZ5241B	CENTS	DZ	$V_Z(I_{ZT}=20_{\text{mA}})=10.45...11.55\text{B}$; $I_L(V_R=8.4\text{B})<2.0\text{мкА}$; $Z_{ZT}(I_{ZT}=20_{\text{mA}})<22\text{Ом}$	A	nc	K
C8S	CMPZ5242B	CENTS	DZ	$V_Z(I_{ZT}=20_{\text{mA}})=11.40...12.60\text{B}$; $I_L(V_R=9.1\text{B})<1.0\text{мкА}$; $Z_{ZT}(I_{ZT}=20_{\text{mA}})<30\text{Ом}$	A	nc	K
C8T	CMPZ5243B	CENTS	DZ	$V_Z(I_{ZT}=9.5_{\text{mA}})=12.35...13.65\text{B}$; $I_L(V_R=9.9\text{B})<0.5\text{мкА}$; $Z_{ZT}(I_{ZT}=9.5_{\text{mA}})<13\text{Ом}$	A	nc	K
C8U	CMPZ5244B	CENTS	DZ	$V_Z(I_{ZT}=9.0_{\text{mA}})=13.30...14.70\text{B}$; $I_L(V_R=10\text{B})<0.1\text{мкА}$; $Z_{ZT}(I_{ZT}=9.0_{\text{mA}})<15\text{Ом}$	A	nc	K
C9	BCF30R	PHIL	PNP	$V_{CB0}=-32\text{B}$; $I_C=-100_{\text{mA}}$; $P_D=350\text{мВт}$; $h_{21}=215...500$; $f_T>100\text{МГц}$	E	B	C
CA	SST4391	SIL	nFET	$V_{DS}=40\text{B}$; $P_D=350\text{мВт}$; $I_{DSS}>50\text{mA}$; $g_F=6\text{мСм}$; $R_{DS(on)}=30\text{Ом}$	D	S	G
CA	BCW61AR	ZETEX	PNP	$V_{CB0}=-32\text{B}$; $I_C=-200_{\text{mA}}$; $P_D=330\text{мВт}$; $h_{21}=120...220$; $f_T>180\text{МГц}$	B	E	C
CA2	CMPD2836	CENTS	2xFID	$I_0=200_{\text{mA}}$; $V_{RRM}=75\text{B}$; $V_F(I_F=100_{\text{mA}})<1.2\text{B}$; $I_R<100\text{нА}$; $t_{RR}<4.0\text{нс}$; $C_T<4.0\text{пФ}$	K2	K1	A2 A1
CA6	CMPD2838	CENTS	2xFID	$I_0=200_{\text{mA}}$; $V_{RRM}=75\text{B}$; $V_F(I_F=100_{\text{mA}})<1.2\text{B}$; $I_R<100\text{нА}$; $t_{RR}<4.0\text{нс}$; $C_T<4.0\text{пФ}$	A2	A1	K2 K1
CB	SST4392	SIL	nFET	$V_{DS}=40\text{B}$; $P_D=350\text{мВт}$; $I_{DSS}>25\text{mA}$; $g_F=6\text{мСм}$; $R_{DS(on)}=60\text{Ом}$	D	S	G
CB	BCW61BR	ZETEX	PNP	$V_{CB0}=-32\text{B}$; $I_C=-200_{\text{mA}}$; $P_D=330\text{мВт}$; $h_{21}=180...310$; $f_T>180\text{МГц}$	B	E	C
CC	BF554	SIEM	NPN	$V_{CB0}=20\text{B}$; $I_C=30_{\text{mA}}$; $P_D=280\text{мВт}$; $h_{21}=60...280$; $f_T>250\text{МГц}$	B	E	C
CC	SST4393	SIL	nFET	$V_{DS}=40\text{B}$; $P_D=350\text{мВт}$; $I_{DSS}>5\text{mA}$; $g_F=6\text{мСм}$; $R_{DS(on)}=100\text{Ом}$	D	S	G
CC	BCW61CR	ZETEX	PNP	$V_{CB0}=-32\text{B}$; $I_C=-200_{\text{mA}}$; $P_D=330\text{мВт}$; $h_{21}=250...460$; $f_T>180\text{МГц}$	B	E	C
CD	BCW61DR	ZETEX	PNP	$V_{CB0}=-32\text{B}$; $I_C=-200_{\text{mA}}$; $P_D=330\text{мВт}$; $h_{21}=380...630$; $f_T>180\text{МГц}$	B	E	C
CDs	BSS81B	SIEM	NPN	$V_{CB0}=75\text{B}$; $I_C=800_{\text{mA}}$; $P_D=330\text{мВт}$; $h_{21}=40...120$; $f_T=250\text{МГц}$	B	E	C
CE	BSS79B	ZETEX	NPN	$V_{CB0}=75\text{B}$; $I_C=800_{\text{mA}}$; $P_D=330\text{мВт}$; $h_{21}=40...120$; $f_T>250\text{МГц}$	B	E	C
CEs	BSS79B	SIEM	NPN	$V_{CB0}=75\text{B}$; $I_C=800_{\text{mA}}$; $P_D=330\text{мВт}$; $h_{21}=40...120$; $f_T=250\text{МГц}$	B	E	C
CF	BSS79C	ZETEX	NPN	$V_{CB0}=75\text{B}$; $I_C=800_{\text{mA}}$; $P_D=330\text{мВт}$; $h_{21}=100...300$; $f_T>250\text{МГц}$	B	E	C
CFs	BSS79C	SIEM	NPN	$V_{CB0}=75\text{B}$; $I_C=800_{\text{mA}}$; $P_D=330\text{мВт}$; $h_{21}=100...300$; $f_T=250\text{МГц}$	B	E	C
CG	BCX71GR	ZETEX	PNP	$V_{CB0}=-45\text{B}$; $I_C=-200_{\text{mA}}$; $P_D=330\text{мВт}$; $h_{21}=120...220$; $f_T>180\text{МГц}$	B	E	C
CGs	BSS81C	SIEM	NPN	$V_{CB0}=75\text{B}$; $I_C=800_{\text{mA}}$; $P_D=330\text{мВт}$; $h_{21}=100...300$; $f_T=250\text{МГц}$	B	E	C
CH	BSS80B	ZETEX	PNP	$V_{CB0}=-60\text{B}$; $I_C=-800_{\text{mA}}$; $P_D=330\text{мВт}$; $h_{21}=40...120$; $f_T>200\text{МГц}$	B	E	C
CHs	BSS80B	SIEM	PNP	$V_{CB0}=-60\text{B}$; $I_C=-800_{\text{mA}}$; $P_D=330\text{мВт}$; $h_{21}=40...120$; $f_T=250\text{МГц}$	B	E	C
CJ	BSS80C	ZETEX	PNP	$V_{CB0}=-60\text{B}$; $I_C=-800_{\text{mA}}$; $P_D=330\text{мВт}$; $h_{21}=100...300$; $f_T>200\text{МГц}$	B	E	C
CJs	BSS80C	SIEM	PNP	$V_{CB0}=-60\text{B}$; $I_C=-800_{\text{mA}}$; $P_D=330\text{мВт}$; $h_{21}=100...300$; $f_T=250\text{МГц}$	B	E	C
CK	BCX71KR	ZETEX	PNP	$V_{CB0}=-45\text{B}$; $I_C=-200_{\text{mA}}$; $P_D=330\text{мВт}$; $h_{21}=380...630$; $f_T>180\text{МГц}$	B	E	C
CKB	CMPT8099	CENTS	NPN	$V_{CB0}=80\text{B}$; $I_C=500_{\text{mA}}$; $P_D=350\text{мВт}$; $h_{21}=100...300$; $f_T>150\text{МГц}$	B	E	C
CL	BSS82B	ZETEX	PNP	$V_{CB0}=-60\text{B}$; $I_C=-800_{\text{mA}}$; $P_D=330\text{мВт}$; $h_{21}=40...120$; $f_T>200\text{МГц}$	B	E	C
CLs	BSS82B	SIEM	PNP	$V_{CB0}=-60\text{B}$; $I_C=-800_{\text{mA}}$; $P_D=330\text{мВт}$; $h_{21}=40...120$; $f_T=250\text{МГц}$	B	E	C
CM	BSS82C	ZETEX	PNP	$V_{CB0}=-60\text{B}$; $I_C=-800_{\text{mA}}$; $P_D=330\text{мВт}$; $h_{21}=100...300$; $f_T>200\text{МГц}$	B	E	C
CMs	BSS82C	SIEM	PNP	$V_{CB0}=-60\text{B}$; $I_C=-800_{\text{mA}}$; $P_D=330\text{мВт}$; $h_{21}=100...300$; $f_T=250\text{МГц}$	B	E	C
CR	BCW60A	ZETEX	NPN	$V_{CB0}=32\text{B}$; $I_C=200_{\text{mA}}$; $P_D=330\text{мВт}$; $h_{21}=120...220$; $f_T>250\text{МГц}$	B	E	C
D0	HSMP-3800	HP	PIN	$I_F<1\text{A}$; $V_{BR}>100\text{B}$; $R_S<2.0\text{Ом}$; $C_D<0.37\text{пФ}$; $R_H>1000\text{Ом}$; $R_L<8\text{Ом}$	A	nc	K
D1	BCW31	ALLEG	NPN	$V_{CB0}=30\text{B}$; $I_{C0}<100\text{нА}$; $h_{21}=110...220$; $V_{CE(sat)}<0.25\text{B}$	B	E	C
D1	BCW31	CDIL	NPN	$V_{CB0}=32\text{B}$; $I_C=100_{\text{mA}}$; $P_D=330\text{мВт}$; $h_{21}=110...220$; $f_T>300\text{МГц}$	B	E	C
D1	BCW31	SAMS	NPN	$V_{CB0}=30\text{B}$; $I_C=100_{\text{mA}}$; $P_D=350\text{мВт}$; $h_{21}=110...220$	B	E	C

SOT23, SOD23 (продолжение)

Код	Типономинал	Фирма	Функция	Особенности	Цоколевка		
					1	2	3
D1	AZ23C2V7	VISH	2xDZ	$V_Z=2.5...2.9B$; $R_Z(I_Z=5mA)=830M$	K1	K2	A1 A2
D1	BCW31	ZETEX	NPN	$V_{CB0}=32B$; $I_C=100mA$; $P_D=330mBT$; $h_{21}=110...220$; $f_T>300MГц$	B	E	C
D10	AZ23C6V2	VISH	2xDZ	$V_Z=5.8...6.6B$; $R_Z(I_Z=5mA)=100M$	K1	K2	A1 A2
D11	AZ23C6V8	VISH	2xDZ	$V_Z=6.4...7.2B$; $R_Z(I_Z=5mA)=80M$	K1	K2	A1 A2
D12	AZ23C7V5	VISH	2xDZ	$V_Z=7.0...7.9B$; $R_Z(I_Z=5mA)=70M$	K1	K2	A1 A2
D13	AZ23C8V2	VISH	2xDZ	$V_Z=7.7...8.7B$; $R_Z(I_Z=5mA)=70M$	K1	K2	A1 A2
D14	AZ23C9V1	VISH	2xDZ	$V_Z=8.5...9.6B$; $R_Z(I_Z=5mA)=100M$	K1	K2	A1 A2
D15	AZ23C10	VISH	2xDZ	$V_Z=9.4...10.6B$; $R_Z(I_Z=5mA)=150M$	K1	K2	A1 A2
D16	AZ23C11	VISH	2xDZ	$V_Z=10.4...11.6B$; $R_Z(I_Z=5mA)=200M$	K1	K2	A1 A2
D17	AZ23C12	VISH	2xDZ	$V_Z=11.4...12.7B$; $R_Z(I_Z=5mA)=200M$	K1	K2	A1 A2
D18	AZ23C13	VISH	2xDZ	$V_Z=12.4...14.1B$; $R_Z(I_Z=5mA)=250M$	K1	K2	A1 A2
D19	AZ23C15	VISH	2xDZ	$V_Z=13.8...15.6B$; $R_Z(I_Z=5mA)=300M$	K1	K2	A1 A2
D1G	KSA812	SAMS	PNP	$V_{CB0}=-60B$; $I_C=-100mA$; $P_D=150mBT$; $h_{21}=200...400$; $f_T>180MГц$	B	E	C
D1L	KSA812	SAMS	PNP	$V_{CB0}=-60B$; $I_C=-100mA$; $P_D=150mBT$; $h_{21}=300...600$; $f_T>180MГц$	B	E	C
D1O	KSA812	SAMS	PNP	$V_{CB0}=-60B$; $I_C=-100mA$; $P_D=150mBT$; $h_{21}=90...180$; $f_T>180MГц$	B	E	C
D1p	BCW31	PHIL	NPN	$V_{CB0}=32B$; $I_C=100mA$; $P_D=250mBT$; $h_{21}=110...220$; $f_T>100MГц$	B	E	C
D1Y	KSA812	SAMS	PNP	$V_{CB0}=-60B$; $I_C=-100mA$; $P_D=150mBT$; $h_{21}=135...270$; $f_T>180MГц$	B	E	C
D2	BCW32	ALLEG	NPN	$V_{CB0}=30B$; $I_{CB0}<100HA$; $h_{21}=200...450$; $V_{CE(sat)}<0.25B$	B	E	C
D2	BCW32	CDIL	NPN	$V_{CB0}=32B$; $I_C=100mA$; $P_D=330mBT$; $h_{21}=200...450$; $f_T>300MГц$	B	E	C
D2	HSMP-3802	HP	2xPIN	$I_F<1A$; $V_{BR}>100B$; $R_S<2.00M$; $C_D<0.37пф$; $R_H>10000M$; $R_L<80M$	A1	K2	K1 K2
D2	AZ23C3	VISH	2xDZ	$V_Z=2.8...3.2B$; $R_Z(I_Z=5mA)=950M$	K1	K2	A1 A2
D2	BCW32	ZETEX	NPN	$V_{CB0}=32B$; $I_C=100mA$; $P_D=330mBT$; $h_{21}=200...450$; $f_T>300MГц$	B	E	C
D20	AZ23C16	VISH	2xDZ	$V_Z=15.3...17.1B$; $R_Z(I_Z=5mA)=400M$	K1	K2	A1 A2
D21	AZ23C18	VISH	2xDZ	$V_Z=16.8...19.1B$; $R_Z(I_Z=5mA)=500M$	K1	K2	A1 A2
D22	AZ23C20	VISH	2xDZ	$V_Z=18.8...21.2B$; $R_Z(I_Z=5mA)=500M$	K1	K2	A1 A2
D23	AZ23C22	VISH	2xDZ	$V_Z=20.8...23.3B$; $R_Z(I_Z=5mA)=550M$	K1	K2	A1 A2
D24	AZ23C24	VISH	2xDZ	$V_Z=22.8...25.6B$; $R_Z(I_Z=5mA)=800M$	K1	K2	A1 A2
D25	AZ23C27	VISH	2xDZ	$V_Z=25.1...28.9B$; $R_Z(I_Z=5mA)=800M$	K1	K2	A1 A2
D26	AZ23C30	VISH	2xDZ	$V_Z=28...32B$; $R_Z(I_Z=5mA)=800M$	K1	K2	A1 A2
D27	AZ23C33	VISH	2xDZ	$V_Z=31...35B$; $R_Z(I_Z=5mA)=800M$	K1	K2	A1 A2
D28	AZ23C36	VISH	2xDZ	$V_Z=34...38B$; $R_Z(I_Z=5mA)=900M$	K1	K2	A1 A2
D29	AZ23C39	VISH	2xDZ	$V_Z=37...41B$; $R_Z(I_Z=5mA)=900M$	K1	K2	A1 A2
D2p	BCW32	PHIL	NPN	$V_{CB0}=32B$; $I_C=100mA$; $P_D=250mBT$; $h_{21}=200...450$; $f_T>100MГц$	B	E	C
D3	BCW33	ALLEG	NPN	$V_{CB0}=30B$; $I_{CB0}<100HA$; $h_{21}=420...800$; $V_{CE(sat)}<0.25B$	B	E	C
D3	BCW33	CDIL	NPN	$V_{CB0}=32B$; $I_C=100mA$; $P_D=250mBT$; $h_{21}=420...800$; $f_T>100MГц$	B	E	C
D3	BCW33	ZETEX	NPN	$V_{CB0}=32B$; $I_C=100mA$; $P_D=330mBT$; $h_{21}=420...800$; $f_T>300MГц$	B	E	C

SOT23, SOD23 (продолжение)

Код	Типономинал	Фирма	Функция	Особенности	Цоколевка		
					1	2	3
D3	AZ23C3V3	VISH	2xDZ	$V_Z=3.1...3.5B$; $R_Z(I_Z=5mA)=950\Omega$	K1	K2	A1 A2
D30	AZ23C43	VISH	2xDZ	$V_Z=40...46B$; $R_Z(I_Z=5mA)=1000\Omega$	K1	K2	A1 A2
D31	AZ23C47	VISH	2xDZ	$V_Z=44...50B$; $R_Z(I_Z=5mA)=1000\Omega$	K1	K2	A1 A2
D32	AZ23C51	VISH	2xDZ	$V_Z=48...54B$; $R_Z(I_Z=5mA)=1000\Omega$	K1	K2	A1 A2
D3p	BCW33	PHIL	NPN	$V_{CB0}=32B$; $I_C=100mA$; $P_D=250mBT$; $h_{21}=420...800$; $f_T>100MГц$	B	E	C
D4	HSMP-3804	HP	2xPIN	$I_F<1A$; $V_{BR}>100B$; $R_S<2.0\Omega$; $C_D<0.37пФ$; $R_H>1000\Omega$; $R_L<8\Omega$	A1	A2	K1 K2
D4	BCW31R	PHIL	NPN	$V_{CB0}=32B$; $I_C=100mA$; $P_D=350mBT$; $h_{21}=110...220$; $f_T>100MГц$	E	B	C
D4	AZ23C3V6	VISH	2xDZ	$V_Z=3.4...3.8B$; $R_Z(I_Z=5mA)=950\Omega$	K1	K2	A1 A2
D4	BCW31R	ZETEX	NPN	$V_{CB0}=32B$; $I_C=100mA$; $P_D=330mBT$; $h_{21}=110...220$; $f_T>300MГц$	B	E	C
D49	CMPD5001S	CENTS	2xDIH	$I_F=400mA$; $V_R=120B$; $V_F(I_F=100mA)<0.9B$; $I_R<100\mu A$; $t_{RR}<50нс$; $C_T<35пФ$	A2	K1	K2 A1
D5	BCW32R	PHIL	NPN	$V_{CB0}=32B$; $I_C=100mA$; $P_D=350mBT$; $h_{21}=200...450$; $f_T>100MГц$	E	B	C
D5	AZ23C3V9	VISH	2xDZ	$V_Z=3.7...4.1B$; $R_Z(I_Z=5mA)=950\Omega$	K1	K2	A1 A2
D5	BCW32R	ZETEX	NPN	$V_{CB0}=32B$; $I_C=100mA$; $P_D=330mBT$; $h_{21}=200...450$; $f_T>300MГц$	B	E	C
D53	CMPD2004	CENTS	FID	$I_F<225mA$; $V_R=240B$; $V_F(I_F=100mA)<1.0B$; $I_R<100\mu A$; $t_{RR}<50нс$; $C_T<5.0пФ$	A	nc	K
D6	BCW33R	PHIL	NPN	$V_{CB0}=32B$; $I_C=100mA$; $P_D=350mBT$; $h_{21}=420...800$; $f_T>100MГц$	E	B	C
D6	AZ23C4V3	VISH	2xDZ	$V_Z=4.0...4.6B$; $R_Z(I_Z=5mA)=950\Omega$	K1	K2	A1 A2
D6	BCW33R	ZETEX	NPN	$V_{CB0}=32B$; $I_C=100mA$; $P_D=350mBT$; $h_{21}=420...800$; $f_T>300MГц$	B	E	C
D7	AZ23C4V7	VISH	2xDZ	$V_Z=4.4...5.0B$; $R_Z(I_Z=5mA)=780\Omega$	K1	K2	A1 A2
D76	BAR18	ALLEG	SHD	$V_{BR}>70B$; $V_F(I_F=1mA)<0.41B$; $I_R<200\mu A$; $C_T<1.7пФ$;	A	nc	K
D76	CMPD6263	CENTS	SHD	$I_F=15mA$; $V_{RRM}=70B$; $V_F(I_F=1mA)<0.395...0.410B$; $I_R<200\mu A$; $C_T<2.0пФ$	A	nc	K
D77	BCF32R	PHIL	NPN	$V_{CB0}=20B$; $I_C=200mA$; $P_D=200mBT$; $h_{21}=200$; $f_T>300MГц$	E	B	C
D7p	BCF32	PHIL	NPN	$V_{CB0}=32B$; $I_C=100mA$; $P_D=250mBT$; $h_{21}=200...450$; $f_T>100MГц$	B	E	C
D8	AZ23C5V1	VISH	2xDZ	$V_Z=4.8...5.4B$; $R_Z(I_Z=5mA)=600\Omega$	K1	K2	A1 A2
D81	BCF33R	PHIL	NPN	$V_{CB0}=20B$; $I_C=200mA$; $P_D=200mBT$; $h_{21}=420$; $f_T>300MГц$	E	B	C
D8p	BCF33	PHIL	NPN	$V_{CB0}=32B$; $I_C=100mA$; $P_D=250mBT$; $h_{21}=420...800$; $f_T>100MГц$	B	E	C
D9	AZ23C5V6	VISH	2xDZ	$V_Z=5.2...6.0B$; $R_Z(I_Z=5mA)=400\Omega$	K1	K2	A1 A2
D95	CMPSH-3	CENTS	SHD	$I_F=100mA$; $V_{RRM}=30B$; $V_F(I_F=100mA)<1.0B$; $I_R<500\mu A$; $C_T<7.0пФ$	A	nc	K
D96	CMPD6263S	CENTS	2xSHD	$I_F=15mA$; $V_{RRM}=70B$; $V_F(I_F=1mA)<0.395...0.410B$; $I_R<200\mu A$; $C_T<2.0пФ$	A2	K1	K2 A1
D97	CMPD6263C	CENTS	2xSHD	$I_F=15mA$; $V_{RRM}=70B$; $V_F(I_F=1mA)<0.395...0.410B$; $I_R<200\mu A$; $C_T<2.0пФ$	A2	K1	K2 A1
D98	CMPD6263A	CENTS	2xSHD	$I_F=15mA$; $V_{RRM}=70B$; $V_F(I_F=1mA)<0.395...0.410B$; $I_R<200\mu A$; $C_T<2.0пФ$	K2	K1	A2 A1
DA	BCW67A	ALLEG	PNP	$V_{CB0}=-45B$; $I_{CB0}<20\mu A$; $h_{21}=100...250$; $V_{CE(sat)}<0.7B$; $f_T>100MГц$	B	E	C
DA	BCW67A	CDIL	PNP	$V_{CB0}=-45B$; $I_C=-800mA$; $P_D=330mBT$; $h_{21}=100...250$; $f_T>100MГц$	B	E	C
DA	BCW67A	ZETEX	PNP	$V_{CB0}=-45B$; $I_C=-800mA$; $P_D=330mBT$; $h_{21}=100...250$; $f_T>100MГц$	B	E	C
DA2	CMPD5001	CENTS	DIH	$I_F=400mA$; $V_{RRM}=120B$; $V_F(I_F=100mA)<0.9B$; $I_R<100\mu A$; $t_{RR}<50нс$; $C_T<35пФ$	A	nc	K

SOT23, SOD23 (продолжение)

Код	Типономинал	Фирма	Функция	Особенности	Цоколевка		
					1	2	3
DA5	CMP5H-3S	CENTS	2xSHD	$I_F=100\text{mA}$; $V_{RRM}=30\text{B}$; $V_F(I_F=100\text{mA})<1.00\text{B}$; $I_R<500\text{нA}$; $C_1=2.0\text{пФ}$; $t_{RR}<5.0\text{нс}$;	A2	K1	K2 A1
DAs	BCW67A	SIEM	PNP	$V_{CB0}=-45\text{B}$; $I_C=-800\text{mA}$; $P_D=330\text{мВт}$; $h_{21}=100\dots250$; $f_T>200\text{МГц}$	B	E	C
DB	BCW67B	ALLEG	PNP	$V_{CB0}=-45\text{B}$; $I_{CB0}<20\text{нA}$; $h_{21}=160\dots400$; $V_{CE(sat)}<0.7\text{B}$; $f_T>100\text{МГц}$	B	E	C
DB	BCW67B	CDIL	PNP	$V_{CB0}=-45\text{B}$; $I_C=-800\text{mA}$; $P_D=330\text{мВт}$; $h_{21}=160\dots400$; $f_T>100\text{МГц}$	B	E	C
DB	BCW67B	ZETEX	PNP	$V_{CB0}=-45\text{B}$; $I_C=-800\text{mA}$; $P_D=330\text{мВт}$; $h_{21}=160\dots400$; $f_T>100\text{МГц}$	B	E	C
DB1	CMP5H-3A	CENTS	2xSHD	$I_F=100\text{mA}$; $V_{RRM}=30\text{B}$; $V_F(I_F=100\text{mA})<1.00\text{B}$; $I_R<500\text{нA}$; $C_1=2.0\text{пФ}$; $t_{RR}<5.0\text{нс}$;	K2	K1	A2 A1
DB2	CMP5H-3C	CENTS	2xSHD	$I_F=100\text{mA}$; $V_{RRM}=30\text{B}$; $V_F(I_F=100\text{mA})<1.00\text{B}$; $I_R<500\text{нA}$; $C_1=2.0\text{пФ}$; $t_{RR}<5.0\text{нс}$;	A2	A1	K2 K1
DB6	CMPD2004S	CENTS	2xFIH	$I_F<225\text{mA}$; $V_{RM}=240\text{B}$; $V_F(I_F=100\text{mA})<1.0\text{B}$; $I_R<100\text{нA}$; $t_{RR}<50\text{нс}$; $C_1=5.0\text{пФ}$	A2	K1	K2 A1
DBs	BCW67B	SIEM	PNP	$V_{CB0}=-45\text{B}$; $I_C=-800\text{mA}$; $P_D=330\text{мВт}$; $h_{21}=160\dots400$; $f_T=200\text{МГц}$	B	E	C
DC	BCW67C	CDIL	PNP	$V_{CB0}=-45\text{B}$; $I_C=-800\text{mA}$; $P_D=330\text{мВт}$; $h_{21}=250\dots630$; $f_T>100\text{МГц}$	B	E	C
DC	BCW67C	ZETEX	PNP	$V_{CB0}=-45\text{B}$; $I_C=-800\text{mA}$; $P_D=330\text{мВт}$; $h_{21}=250\dots630$; $f_T>100\text{МГц}$	B	E	C
DCs	BCW67C	SIEM	PNP	$V_{CB0}=-45\text{B}$; $I_C=-800\text{mA}$; $P_D=330\text{мВт}$; $h_{21}=250\dots630$; $f_T=200\text{МГц}$	B	E	C
DF	BCW68F	ALLEG	PNP	$V_{CB0}=-60\text{B}$; $I_{CB0}<20\text{нA}$; $h_{21}=100\dots250$; $V_{CE(sat)}<0.7\text{B}$; $f_T>100\text{МГц}$	B	E	C
DF	BCW68F	CDIL	PNP	$V_{CB0}=-60\text{B}$; $I_C=-800\text{mA}$; $P_D=330\text{мВт}$; $h_{21}=100\dots250$; $f_T>100\text{МГц}$	B	E	C
DF	BCW68F	ZETEX	PNP	$V_{CB0}=-60\text{B}$; $I_C=-800\text{mA}$; $P_D=330\text{мВт}$; $h_{21}=100\dots250$; $f_T>100\text{МГц}$	B	E	C
DFs	BCW68F	SIEM	PNP	$V_{CB0}=-60\text{B}$; $I_C=-800\text{mA}$; $P_D=330\text{мВт}$; $h_{21}=100\dots250$; $f_T=200\text{МГц}$	B	E	C
DG	BCW68G	ALLEG	PNP	$V_{CB0}=-60\text{B}$; $I_{CB0}<20\text{нA}$; $h_{21}=160\dots400$; $V_{CE(sat)}<0.7\text{B}$; $f_T>100\text{МГц}$	B	E	C
DG	BCW68G	CDIL	PNP	$V_{CB0}=-60\text{B}$; $I_C=-800\text{mA}$; $P_D=330\text{мВт}$; $h_{21}=160\dots400$; $f_T>100\text{МГц}$	B	E	C
DG	BCW68G	ZETEX	PNP	$V_{CB0}=-60\text{B}$; $I_C=-800\text{mA}$; $P_D=330\text{мВт}$; $h_{21}=160\dots400$; $f_T>100\text{МГц}$	B	E	C
DGs	BCW68G	SIEM	PNP	$V_{CB0}=-60\text{B}$; $I_C=-800\text{mA}$; $P_D=330\text{мВт}$; $h_{21}=160\dots400$; $f_T=200\text{МГц}$	B	E	C
DH	BCW68H	CDIL	PNP	$V_{CB0}=-60\text{B}$; $I_C=-800\text{mA}$; $P_D=330\text{мВт}$; $h_{21}=250\dots630$; $f_T>100\text{МГц}$	B	E	C
DH	BCW68H	ZETEX	PNP	$V_{CB0}=-60\text{B}$; $I_C=-800\text{mA}$; $P_D=330\text{мВт}$; $h_{21}=250\dots630$; $f_T>100\text{МГц}$	B	E	C
DHs	BCW68H	SIEM	PNP	$V_{CB0}=-60\text{B}$; $I_C=-800\text{mA}$; $P_D=330\text{мВт}$; $h_{21}=250\dots630$; $f_T=200\text{МГц}$	B	E	C
DKs	BCX42	SIEM	PNP	$V_{CB0}=-12\text{B}$; $I_C=-800\text{mA}$; $P_D=330\text{мВт}$; $h_{21}>63$; $f_T=150\text{МГц}$	B	E	C
DR	BCW60BR	ZETEX	NPN	$V_{CB0}=32\text{B}$; $I_C=200\text{mA}$; $P_D=330\text{мВт}$; $h_{21}=180\dots310$; $f_T>250\text{МГц}$	B	E	C
E0	HSMP-3810	HP	PIN	$I_F<1\text{A}$; $V_{BR}>100\text{B}$; $R_S<3.0\text{Ом}$; $C_D<0.37\text{пФ}$; $R_H>1500\text{Ом}$; $R_L<100\text{Ом}$;	A	nc	K
E1	BFS17LT1	MOT	NPN	$V_{CB0}=15\text{B}$; $I_C=50\text{mA}$; $P_D=200\text{мВт}$; $h_{21}=20\dots150$; $f_T>1000\text{МГц}$	B	E	C
E1	BFS17	ZETEX	NPN	$V_{CB0}=25\text{B}$; $I_C=25\text{mA}$; $P_D=330\text{мВт}$; $h_{21}=25\dots150$; $f_T>1000\text{МГц}$	B	E	C
E1H	BFS17H	ZETEX	NPN	$V_{CB0}=25\text{B}$; $I_C=25\text{mA}$; $P_D=330\text{мВт}$; $h_{21}=70\dots200$; $f_T>1000\text{МГц}$	B	E	C
E1L	BFS17L	ZETEX	NPN	$V_{CB0}=25\text{B}$; $I_C=25\text{mA}$; $P_D=330\text{мВт}$; $h_{21}=25\dots100$; $f_T>1000\text{МГц}$	B	E	C
E1O	KSC2859	SAMS	NPN	$V_{CB0}=35\text{B}$; $I_C=500\text{mA}$; $P_D=150\text{мВт}$; $h_{21}=70\dots140$; $f_T>300\text{МГц}$	B	E	C
E1Y	KSC2859	SAMS	NPN	$V_{CB0}=35\text{B}$; $I_C=500\text{mA}$; $P_D=150\text{мВт}$; $h_{21}=120\dots240$; $f_T>300\text{МГц}$	B	E	C
E2	HSMP-3812	HP	2xPIN	$I_F<1\text{A}$; $V_{BR}>100\text{B}$; $R_S<2.0\text{Ом}$; $C_D<0.37\text{пФ}$; $R_H>1000\text{Ом}$; $R_L<80\text{Ом}$;	A1	K2	K1 A2
E2	BAL99	ZETEX	DI	$V_R<70\text{B}$; $I_F<100\text{mA}$; $V_F(I_F=50\text{mA})<1.1\text{B}$; $I_R<2.5\text{мкA}$; $C_D<1.5\text{пФ}$; $t_{RR}<6\text{нс}$	nc	K	A
E3	HSMP-3813	HP	2xPIN	$I_F<1\text{A}$; $V_{BR}>100\text{B}$; $R_S<2.0\text{Ом}$; $C_D<0.37\text{пФ}$; $R_H>1000\text{Ом}$; $R_L<80\text{Ом}$;	K1	K2	A1 A2
E3	BAR99	ZETEX	DI	$V_R<70\text{B}$; $I_F<100\text{mA}$; $V_F(I_F=50\text{mA})<1.1\text{B}$; $I_R<2.5\text{мкA}$; $C_D<1.5\text{пФ}$; $t_{RR}<6\text{нс}$	K	nc	A
E4	HSMP-3814	HP	2xPIN	$I_F<1\text{A}$; $V_{BR}>100\text{B}$; $R_S<2.0\text{Ом}$; $C_D<0.37\text{пФ}$; $R_H>1000\text{Ом}$; $R_L<80\text{Ом}$;	A1	A2	K1 K2

SOT23, SOD23 (продолжение)

Код	Типономинал	Фирма	Функция	Особенности	Цоколевка		
					1	2	3
E6	ZC2800E	ZETEX	SHD	$V_R < 75B; V_F(I_F = 1mA) < 0.41B; I_R < 0.2mA; C_D < 2.0пФ$	A	nc	K
E8	ZC2811E	ZETEX	SHD	$V_R < 15B; V_F(I_F = 1mA) < 0.41B; I_R < 0.1mA; C_D < 1.20пФ$	A	nc	K
E9	ZC5800E	ZETEX	SHD	$V_R < 50B; V_F(I_F = 1mA) < 0.41B; I_R < 0.2mA; C_D < 2.0пФ$	A	nc	K
EA	BCW65A	ALLEG	NPN	$V_{CB0} = 60B; I_{C0} = 20mA; h_{21} = 100...250; f_T > 100MГц$	B	E	C
EA	BCW65A	CDIL	NPN	$V_{CB0} = 60B; I_{C0} = 800mA; P_D = 330mBT; h_{21} = 100...250; f_T > 100MГц$	B	E	C
EA	BCW65A	ZETEX	NPN	$V_{CB0} = 60B; I_{C0} = 800mA; P_D = 330mBT; h_{21} = 100...250; f_T > 100MГц$	B	E	C
EAs	BCW65A	SIEM	NPN	$V_{CB0} = 60B; I_{C0} = 800mA; P_D = 330mBT; h_{21} = 100...250; f_T = 170MГц$	B	E	C
EB	BCW65B	ALLEG	NPN	$V_{CB0} = 60B; I_{C0} < 20mA; h_{21} = 160...400; f_T > 100MГц$	B	E	C
EB	BCW65B	CDIL	NPN	$V_{CB0} = 60B; I_{C0} = 800mA; P_D = 330mBT; h_{21} = 160...400; f_T > 100MГц$	B	E	C
EB	HSMP-4810	HP	PIN	$I_F < 1A; P_D < 250mBT; V_{BR} > 100B; R_S < 3.0Om; C_D < 0.40пФ; L_T = 1.0нГ$	K	K	A
EB	BCW65B	ZETEX	NPN	$V_{CB0} = 60B; I_{C0} = 800mA; P_D = 330mBT; h_{21} = 160...400; f_T > 100MГц$	B	E	C
EBs	BCW65B	SIEM	NPN	$V_{CB0} = 60B; I_{C0} = 800mA; P_D = 330mBT; h_{21} = 100...250; f_T = 170MГц$	B	E	C
EC	BCW65C	CDIL	NPN	$V_{CB0} = 60B; I_{C0} = 800mA; P_D = 330mBT; h_{21} = 250...630; f_T > 100MГц$	B	E	C
EC	BCW65C	ZETEX	NPN	$V_{CB0} = 60B; I_{C0} = 800mA; P_D = 330mBT; h_{21} = 250...630; f_T > 100MГц$	B	E	C
ECs	BCW65C	SIEM	NPN	$V_{CB0} = 60B; I_{C0} = 800mA; P_D = 330mBT; h_{21} = 250...630; f_T = 170MГц$	B	E	C
EF	BCW66F	ALLEG	NPN	$V_{CB0} = 75B; I_{C0} < 20mA; h_{21} = 100...250; f_T > 100MГц$	B	E	C
EF	BCW66F	CDIL	NPN	$V_{CB0} = 75B; I_{C0} = 800mA; P_D = 330mBT; h_{21} = 100...250; f_T > 100MГц$	B	E	C
EF	BCW66F	ZETEX	NPN	$V_{CB0} = 75B; I_{C0} = 800mA; P_D = 330mBT; h_{21} = 100...250; f_T > 100MГц$	B	E	C
EFs	BCW66F	SIEM	NPN	$V_{CB0} = 75B; I_{C0} = 800mA; P_D = 330mBT; h_{21} = 100...250; f_T > 170MГц$	B	E	C
EG	BCW66G	ALLEG	NPN	$V_{CB0} = 75B; I_{C0} < 20mA; h_{21} = 160...400; f_T > 100MГц$	B	E	C
EG	BCW66G	CDIL	NPN	$V_{CB0} = 75B; I_{C0} = 800mA; P_D = 330mBT; h_{21} = 160...400; f_T > 100MГц$	B	E	C
EG	BCW66G	ZETEX	NPN	$V_{CB0} = 75B; I_{C0} = 800mA; P_D = 330mBT; h_{21} = 160...400; f_T > 100MГц$	B	E	C
EGs	BCW66G	SIEM	NPN	$V_{CB0} = 75B; I_{C0} = 800mA; P_D = 330mBT; h_{21} = 160...400; f_T = 170MГц$	B	E	C
EH	BCW66H	CDIL	NPN	$V_{CB0} = 75B; I_{C0} = 800mA; P_D = 330mBT; h_{21} = 250...630; f_T > 100MГц$	B	E	C
EH	BCW66H	ZETEX	NPN	$V_{CB0} = 75B; I_{C0} = 800mA; P_D = 330mBT; h_{21} = 250...630; f_T > 100MГц$	B	E	C
EHs	BCW66H	SIEM	NPN	$V_{CB0} = 75B; I_{C0} = 800mA; P_D = 330mBT; h_{21} = 250...630; f_T > 170MГц$	B	E	C
EK	BCX41	ZETEX	NPN	$V_{CB0} = 125B; I_{C0} = 800mA; P_D = 330mBT; h_{21} > 63; f_T > 100MГц$	B	E	C
EKs	BCX41	SIEM	NPN	$V_{CB0} = 125B; I_{C0} = 800mA; P_D = 330mBT; h_{21} > 63; f_T = 100MГц$	B	E	C
E0	KTC3265	KEC	NPN	$V_{CB0} = 35B; I_{C0} = 800mA; P_D = 200mBT; h_{21} = 100...200; f_T > 120MГц$	B	E	C
EY	KTC3265	KEC	NPN	$V_{CB0} = 35B; I_{C0} = 800mA; P_D = 200mBT; h_{21} = 160...320; f_T > 120MГц$	B	E	C
F0	HSMP-4810	HP	PIN	$I_F < 1A; V_{BR} > 50B; R_S < 0.6Om; C_D < 0.8пФ$	A	nc	K
F1	KTC1009F1	SAMS	NPN	$V_{CB0} = 50B; I_{C0} = 50mA; P_D = 350mBT; h_{21} = 30...60; f_T > 150MГц$	B	E	C
F1O	KSA1182	SAMS	PNP	$V_{CB0} = -35B; I_{C0} = -500mA; P_D = 150mBT; h_{21} = 70...140; f_T > 200MГц$	B	E	C
F1p	BFS18	PHIL	NPN	$V_{CB0} = 30B; I_{C0} = 30mA; P_D = 250mBT; h_{21} = 35...125; f_T = 200MГц$	B	E	C
F1Y	KSA1182	SAMS	PNP	$V_{CB0} = -35B; I_{C0} = -500mA; P_D = 150mBT; h_{21} = 120...240; f_T > 200MГц$	B	E	C
F2	HSMP-3822	HP	2xPIN	$I_F < 1A; V_{BR} > 50B; R_S < 0.6Om; C_D < 0.8пФ$	A1	K2	K1 A2
F2	KST1009F2	SAMS	NPN	$V_{CB0} = 50B; I_{C0} = 50mA; P_D = 350mBT; h_{21} = 40...80; f_T > 150MГц$	B	E	C
F2p	BFS19	PHIL	NPN	$V_{CB0} = 30B; I_{C0} = 30mA; P_D = 250mBT; h_{21} = 65...225; f_T = 260MГц$	B	E	C
F3	HSMP-3823	HP	2xPIN	$I_F < 1A; V_{BR} > 50B; R_S < 0.6Om; C_D < 0.8пФ$	K1	K2	A1 A2
F3	KST1009F3	SAMS	NPN	$V_{CB0} = 50B; I_{C0} = 50mA; P_D = 350mBT; h_{21} = 60...120; f_T > 150MГц$	B	E	C
F4	HSMP-3824	HP	2xPIN	$I_F < 1A; V_{BR} > 50B; R_S < 0.6Om; C_D < 0.8пФ$	A1	A2	K1 K2
F4	BFS18R	PHIL	NPN	$V_{CB0} = 20B; I_{C0} = 30mA; P_D = 110mBT; h_{21} = 35; f_T = 200MГц$	E	B	C
F4	KST1009F4	SAMS	NPN	$V_{CB0} = 50B; I_{C0} = 50mA; P_D = 350mBT; h_{21} = 90...180; f_T > 150MГц$	B	E	C
F5	BFS19R	PHIL	NPN	$V_{CB0} = 20B; I_{C0} = 30mA; P_D = 200mBT; h_{21} = 225; f_T = 260MГц$	E	B	C

SOT23, SOD23 (продолжение)

Код	Типономинал	Фирма	Функция	Особенности	Цоколевка		
					1	2	3
F5	KST1009F5	SAMS	NPN	$V_{CB0}=50B; I_C=50mA; P_D=350mBт; h_{21}=135...270; f_T>150MГц$	B	E	C
F8p	BF828	PHIL	PNP	$V_{CB0}=-30B; I_C=-25mA; P_D=250mBт; f_T=450$	B	E	C
FA	HSMP-4820	HP	PIN	$I_F<1A; P_D<250mBт; V_{BR}>50B; R_S<0.6Om; C_D<1.0пФ; L_T=1.0нГ$	A	A	K
FDp	BCV26	PHIL	PNP	$V_{CB0}=-40B; I_C=-300mA; P_D=250mBт; h_{21}>20000; f_T=220MГц$	B	E	C
FDs	BCV26	SIEM	PNP	$V_{CB0}=-40B; I_C=-500mA; P_D=360mBт; h_{21}>10000; f_T=200MГц$	B	E	C
Fep	BCV46	PHIL	PNP	$V_{CB0}=-80B; I_C=-500mA; P_D=250mBт; h_{21}>4000; f_T=220MГц$	B	E	C
FEs	BCV46	SIEM	PNP	$V_{CB0}=-80B; I_C=-500mA; P_D=360mBт; h_{21}>4000; f_T=200MГц$	B	E	C
FFp	BCV27	PHIL	PNP	$V_{CB0}=40B; I_C=300mA; P_D=250mBт; h_{21}>20000; f_T=220MГц$	B	E	C
FFs	BCV27	SIEM	NPN	$V_{CB0}=40B; I_C=500mA; P_D=360mBт; h_{21}>10000; f_T=170MГц$	B	E	C
FGp	BCV47	PHIL	NPN	$V_{CB0}=80B; I_C=500mA; P_D=250mBт; h_{21}>4000; f_T=220MГц$	B	E	C
FGs	BCV47	SIEM	NPN	$V_{CB0}=80B; I_C=500mA; P_D=360mBт; h_{21}>4000; f_T=170MГц$	B	E	C
FHs	BFN24	SIEM	NPN	$V_{CB0}=250B; I_C=200mA; P_D=360mBт; h_{21}>40; f_T=70MГц$	B	E	C
FJs	BFN26	SIEM	NPN	$V_{CB0}=300B; I_C=200mA; P_D=360mBт; h_{21}>30; f_T=70MГц$	B	E	C
FKs	BFN25	SIEM	PNP	$V_{CB0}=-250B; I_C=-200mA; P_D=360mBт; h_{21}>40; f_T=100MГц$	B	E	C
FLs	BFN27	SIEM	PNP	$V_{CB0}=-300B; I_C=-200mA; P_D=360mBт; h_{21}>30; f_T=100MГц$	B	E	C
G0	HSMP-3890	HP	PIN	$I_F<1A; P_D<250mBт; V_{BR}>100B; R_S<2.5Om; C_D<0.30пФ$	A	nc	K
G1	BFS20	ZETEX	NPN	$V_{CB0}=30B; I_C=25mA; P_D=330mBт; h_{21}=40...85; f_T>450MГц$	B	E	C
G1p	BFS20	PHIL	NPN	$V_{CB0}=30B; I_C=25mA; P_D=250mBт; h_{21}>40; f_T=450MГц$	B	E	C
G2	HSMP-3892	HP	2xPIN	$I_F<1A; P_D<250mBт; V_{BR}>100B; R_S<2.5Om; C_D<0.30пФ$	A1	K2	K1 A2
G3	HSMP-3893	HP	2xPIN	$I_F<1A; P_D<250mBт; V_{BR}>100B; R_S<2.5Om; C_D<0.30пФ$	K1	K2	A1 A2
G3	BAR63	SIEM	PIN	$V_R<50B; I_F<100mA; V_F(I_F=100mA)<1.2B; I_R<0.05mA; C_D<0.3пФ$	A	nc	K
G4	HSMP-3894	HP	2xPIN	$I_F<1A; P_D<250mBт; V_{BR}>100B; R_S<2.5Om; C_D<0.30пФ$	A1	A2	K1 K2
G4	BAR63	SIEM	PIN	$V_R<50B; I_F<100mA; V_F(I_F=100mA)<1.2B; I_R<0.05mA; C_D<0.3пФ$	A1	K2	K1 A2
G6	BAR63-06	SIEM	2xPIN	$V_R<50B; I_F<100mA; V_F(I_F=100mA)<1.2B; I_R<0.05mA; C_D<0.3пФ$	K1	K2	A1 A2
G6A	BC817-16	TOSH	NPN	$V_{CB0}=50B; I_C=800mA; P_D=330mBт; h_{21}=100...250; f_T=150MГц$	B	E	C
G6B	BC817-25	TOSH	NPN	$V_{CB0}=50B; I_C=800mA; P_D=330mBт; h_{21}=160...400; f_T=150MГц$	B	E	C
GA	HSMP-4890	HP	PIN	$I_F<1A; P_D<250mBт; V_{BR}>100B; R_S<2.5Om; C_D<0.375пФ; L_T=1.0нГ$	A	A	K
GEs	BFR35AP	SIEM	NPN	$V_{CB0}=20B; I_C=30mA; P_D=280mBт; h_{21}=40...200; f_T=5000MГц$	B	E	C
GFs	BFR92P	SIEM	NPN	$V_{CB0}=20B; I_C=30mA; P_D=280mBт; h_{21}=40...200; f_T=5000MГц$	B	E	C
GG	BFR93P	SIEM	NPN	$V_{CB0}=20B; I_C=50mA; P_D=280mBт; h_{21}>30; f_T=5000MГц$	B	E	C
H1	BCW69	ALLEG	PNP	$V_{CB0}=-50B; I_{CB0}<100mA; h_{21}=120...260; V_{CE(sat)}<0.3B$	B	E	C
H1	BCW69	CDIL	PNP	$V_{CB0}=-50B; I_C=-100mA; P_D=250mBт; h_{21}=120...260; f_T>100MГц$	B	E	C
H1	SST4416	SIL	nFET	$V_{DS}=30B; P_D=350mBт; I_{DSS}=5...15mA; g_f=4.5Mcm; R_{DS(on)}=150Om$	D	S	G
H1	BCW69	ZETEX	PNP	$V_{CB0}=-50B; I_C=-100mA; P_D=330mBт; h_{21}=120...260; f_T>150MГц$	B	E	C
H1O	KSC2755	SAMS	NPN	$V_{CB0}=30B; I_C=20mA; P_D=150mBт; h_{21}=70...140; f_T>600MГц$	B	E	C
H1p	BCW69	PHIL	PNP	$V_{CB0}=-50B; I_C=-100mA; P_D=250mBт; h_{21}=120...260; f_T>100MГц$	B	E	C
H1R	KSC2755	SAMS	NPN	$V_{CB0}=30B; I_C=20mA; P_D=150mBт; h_{21}=40...80; f_T>600MГц$	B	E	C
H1Y	KSC2755	SAMS	NPN	$V_{CB0}=30B; I_C=20mA; P_D=150mBт; h_{21}=120...240; f_T>600MГц$	B	E	C
H2	BCW70	ALLEG	PNP	$V_{CB0}=-50B; I_{CB0}<100mA; h_{21}=215...500; V_{CE(sat)}<0.3B$	B	E	C
H2	BCW70	CDIL	PNP	$V_{CB0}=-50B; I_C=-100mA; P_D=250mBт; h_{21}=215...500; f_T>100MГц$	B	E	C
H2	BCW70	ZETEX	PNP	$V_{CB0}=-50B; I_C=-100mA; P_D=330mBт; h_{21}=215...500; f_T>150MГц$	B	E	C
H2O	KSC2756	SAMS	NPN	$V_{CB0}=20B; I_C=30mA; P_D=150mBт; h_{21}=90...180; f_T>850MГц$	B	E	C
H2p	BCW70	PHIL	PNP	$V_{CB0}=-50B; I_C=-100mA; P_D=250mBт; h_{21}=215...500; f_T>100MГц$	B	E	C
H2R	KSC2756	SAMS	NPN	$V_{CB0}=20B; I_C=30mA; P_D=150mBт; h_{21}=60...120; f_T>850MГц$	B	E	C
H2Y	KSC2756	SAMS	NPN	$V_{CB0}=20B; I_C=30mA; P_D=150mBт; h_{21}=120...240; f_T>850MГц$	B	E	C

SOT23, SOD23 (продолжение)

Код	Типономинал	Фирма	Функция	Особенности	Цоколевка		
					1	2	3
H3	BCW89	CDIL	PNP	$V_{CB0}=-80B; I_C=-100mA; P_D=250mBT; h_{21}=120...260; f_T>100MГц$	B	E	C
H3	KDV153	KEC	BD	$V_R=20B; I_R=10nA; C_{2V}=15пФ; C_{10V}=5пФ; R_S<0.6Om$	A	nc	K
H3	BCW89	ZETEX	PNP	$V_{CB0}=-80B; I_C=-100mA; P_D=330mBT; h_{21}=120...260; f_T>150MГц$	B	E	C
H31	BCW89R	PHIL	PNP	$V_{CB0}=-60B; I_C=-100mA; P_D=350mBT; h_{21}=120...260; f_T=150MГц$	E	B	C
H3O	KSC2757	SAMS	NPN	$V_{CB0}=30B; I_C=50mA; P_D=150mBT; h_{21}=90...180; f_T>1100MГц$	B	E	C
H3p	BCW89	PHIL	PNP	$V_{CB0}=-80B; I_C=-100mA; P_D=250mBT; h_{21}=120...260; f_T>150MГц$	B	E	C
H3R	KSC2757R	SAMS	NPN	$V_{CB0}=30B; I_C=50mA; P_D=150mBT; h_{21}=60...120; f_T>1100MГц$	B	E	C
H3Y	KSC2757Y	SAMS	NPN	$V_{CB0}=30B; I_C=50mA; P_D=150mBT; h_{21}=120...240; f_T>1100MГц$	B	E	C
H4	BCW69R	PHIL	PNP	$V_{CB0}=-45B; I_C=-100mA; P_D=350mBT; h_{21}=120...260; f_T=100MГц$	E	B	C
H4	SST5484	SIL	nFET	$V_{DS}=25B; P_D=350mBT; I_{DSS}=1...5mA; g_f=2mCm$	D	S	G
H4	BCW69R	ZETEX	PNP	$V_{CB0}=-50B; I_C=-100mA; P_D=330mBT; h_{21}=120...260; f_T>150MГц$	B	E	C
H4Z	KSC2758	SAMS	NPN	$V_{CB0}=30B; I_C=20mA; P_D=150mBT; h_{21}=60...240; f_T>1000MГц$	B	E	C
H5	BCW70R	PHIL	PNP	$V_{CB0}=-45B; I_C=-100mA; P_D=350mBT; h_{21}=215...500; f_T>100MГц$	E	B	C
H5	SST5485	SIL	nFET	$V_{DS}=25B; P_D=350mBT; I_{DSS}=4...10mA; g_f=3.5mCm$	D	S	G
H5	BCW70R	ZETEX	PNP	$V_{CB0}=-50B; I_C=-100mA; P_D=330mBT; h_{21}=215...500; f_T>150MГц$	B	E	C
H5O	KSC2223	SAMS	NPN	$V_{CB0}=30B; I_C=20mA; P_D=150mBT; h_{21}=60...120; f_T>600MГц$	B	E	C
H5R	KSC2223	SAMS	NPN	$V_{CB0}=30B; I_C=20mA; P_D=150mBT; h_{21}=40...80; f_T>600MГц$	B	E	C
H5Y	KSC2223	SAMS	NPN	$V_{CB0}=30B; I_C=20mA; P_D=150mBT; h_{21}=90...180; f_T>600MГц$	B	E	C
H6	SST5486	SIL	nFET	$V_{DS}=25B; P_D=350mBT; I_{DSS}=8...20mA; g_f=4mCm$	D	S	G
H6	BCW89R	ZETEX	PNP	$V_{CB0}=-80B; I_C=-100mA; P_D=330mBT; h_{21}=120...260; f_T>150MГц$	B	E	C
H6O	KSC2759	SAMS	NPN	$V_{CB0}=30B; I_C=50mA; P_D=150mBT; h_{21}=60...120; f_T>2000MГц$	B	E	C
H6R	KSC2759	SAMS	NPN	$V_{CB0}=30B; I_C=50mA; P_D=150mBT; h_{21}=40...80; f_T>2000MГц$	B	E	C
H6Y	KSC2759	SAMS	NPN	$V_{CB0}=30B; I_C=50mA; P_D=150mBT; h_{21}=90...180; f_T>2000MГц$	B	E	C
H71	BCF70R	PHIL	PNP	$V_{CB0}=-45B; I_C=-100mA; P_D=350mBT; h_{21}=215...500; f_T>100MГц$	E	B	C
H7p	BCF70	PHIL	PNP	$V_{CB0}=-50B; I_C=-100mA; P_D=250mBT; h_{21}=215...500; f_T>100MГц$	B	E	C
H8Z	KSC2734	SAMS	NPN	$V_{CB0}=20B; I_C=50mA; P_D=150mBT; h_{21}=20...200; f_T>3500MГц$	B	E	C
H9Z	KSC3120	SAMS	NPN	$V_{CB0}=30B; I_C=50mA; P_D=150mBT; h_{21}=40...200; f_T>2400MГц$	B	E	C
HAO	KSC3123	SAMS	NPN	$V_{CB0}=30B; I_C=50mA; P_D=150mBT; h_{21}=90...180; f_T>1400MГц$	B	E	C
HAR	KSC3123	SAMS	NPN	$V_{CB0}=30B; I_C=50mA; P_D=150mBT; h_{21}=60...120; f_T>1400MГц$	B	E	C
HAY	KSC3123	SAMS	NPN	$V_{CB0}=30B; I_C=50mA; P_D=150mBT; h_{21}=120...240; f_T>1400MГц$	B	E	C
HBs	BFN22	SIEM	NPN	$V_{CB0}=25B; I_C=50mA; P_D=360mBT; h_{21}>50; f_T=100MГц$	B	E	C
HCs	BFN23	SIEM	PNP	$V_{CB0}=-25B; I_C=-50mA; P_D=360mBT; h_{21}>50; f_T=100MГц$	B	E	C
IO	KTA1298	KEC	PNP	$V_{CB0}=-35B; I_C=-800mA; P_D=200mBT; h_{21}=100...200; f_T>120MГц$	B	E	C
IY	KTA1298	KEC	PNP	$V_{CB0}=-35B; I_C=-800mA; P_D=200mBT; h_{21}=160...320; f_T>120MГц$	B	E	C
J0	SST110	SIL	nFET	$V_{DS}=25B; P_D=350mBT; I_{DSS}>10mA; g_f=17mCm; R_{DS(on)}=18Jv$	D	S	G
J1A	ZC830A	ZETEX	BD	$V_R<25B; C_{2V}=10\pm 10\%пФ; C_{2V}/C_{20V}=4.5...6; Q>300$	A	nc	K
J1B	ZC830B	ZETEX	BD	$V_R<25B; C_{2V}=10\pm 5\%пФ; C_{2V}/C_{20V}=4.5...6; Q>300$	A	nc	K
J1O	KSA1298	SAMS	PNP	$V_{CB0}=-30B; I_C=-800mA; P_D=200mBT; h_{21}=100...200; f_T>120MГц$	B	E	C
J1S	ZC830	ZETEX	BD	$V_R<25B; C_{2V}=10\pm 20\%пФ; C_{2V}/C_{20V}=4.5...6; Q>300$	A	nc	K
J1Y	KSA1298	SAMS	PNP	$V_{CB0}=-30B; I_C=-800mA; P_D=200mBT; h_{21}=160...320; f_T>120MГц$	B	E	C
J2A	ZC833A	ZETEX	BD	$V_R<25B; C_{2V}=33\pm 10\%пФ; C_{2V}/C_{20V}=5...6.5; Q>200$	A	nc	K
J2B	ZC833B	ZETEX	BD	$V_R<25B; C_{2V}=33\pm 5\%пФ; C_{2V}/C_{20V}=5...6.5; Q>200$	A	nc	K
J2S	ZC833	ZETEX	BD	$V_R<25B; C_{2V}=33\pm 20\%пФ; C_{2V}/C_{20V}=5...6.5; Q>200$	A	nc	K
J3A	ZC831A	ZETEX	BD	$V_R<25B; C_{2V}=15\pm 10\%пФ; C_{2V}/C_{20V}=4.5...6; Q>300$	A	nc	K

SOT23, SOD23 (продолжение)

Код	Типономинал	Фирма	Функция	Особенности	Цоколевка		
					1	2	3
J3B	ZC831B	ZETEX	BD	$V_R < 25B$; $C_{2V} = 15 \pm 5\% \text{ пФ}$; $C_{2V}/C_{20V} = 4.5 \dots 6$; $Q > 300$	A	nc	K
J3S	ZC831	ZETEX	BD	$V_R < 25B$; $C_{2V} = 15 \pm 20\% \text{ пФ}$; $C_{2V}/C_{20V} = 4.5 \dots 6$; $Q > 300$	A	nc	K
J4A	ZC832A	ZETEX	BD	$V_R < 25B$; $C_{2V} = 22 \pm 10\% \text{ пФ}$; $C_{2V}/C_{20V} = 5 \dots 6.5$; $Q > 200$	A	nc	K
J4B	ZC832B	ZETEX	BD	$V_R < 25B$; $C_{2V} = 22 \pm 5\% \text{ пФ}$; $C_{2V}/C_{20V} = 5 \dots 6.5$; $Q > 200$	A	nc	K
J4S	ZC832	ZETEX	BD	$V_R < 25B$; $C_{2V} = 22 \pm 20\% \text{ пФ}$; $C_{2V}/C_{20V} = 5 \dots 6.5$; $Q > 200$	A	nc	K
J5A	ZC834A	ZETEX	BD	$V_R < 25B$; $C_{2V} = 47 \pm 10\% \text{ пФ}$; $C_{2V}/C_{20V} = 5 \dots 6.5$; $Q > 200$	A	nc	K
J5B	ZC834B	ZETEX	BD	$V_R < 25B$; $C_{2V} = 47 \pm 5\% \text{ пФ}$; $C_{2V}/C_{20V} = 5 \dots 6.5$; $Q > 200$	A	nc	K
J5S	ZC834	ZETEX	BD	$V_R < 25B$; $C_{2V} = 47 \pm 20\% \text{ пФ}$; $C_{2V}/C_{20V} = 5 \dots 6.5$; $Q > 200$	A	nc	K
J6A	ZC835A	ZETEX	BD	$V_R < 25B$; $C_{2V} = 68 \pm 10\% \text{ пФ}$; $C_{2V}/C_{20V} = 5 \dots 6.5$; $Q > 100$	A	nc	K
J6B	ZC835B	ZETEX	BD	$V_R < 25B$; $C_{2V} = 68 \pm 5\% \text{ пФ}$; $C_{2V}/C_{20V} = 5 \dots 6.5$; $Q > 100$	A	nc	K
J6S	ZC835	ZETEX	BD	$V_R < 25B$; $C_{2V} = 68 \pm 20\% \text{ пФ}$; $C_{2V}/C_{20V} = 5 \dots 6.5$; $Q > 100$	A	nc	K
J7A	ZC836A	ZETEX	BD	$V_R < 25B$; $C_{2V} = 100 \pm 10\% \text{ пФ}$; $C_{2V}/C_{20V} = 5 \dots 6.5$; $Q > 100$	A	nc	K
J7B	ZC836B	ZETEX	BD	$V_R < 25B$; $C_{2V} = 100 \pm 5\% \text{ пФ}$; $C_{2V}/C_{20V} = 5 \dots 6.5$; $Q > 100$	A	nc	K
J7S	ZC836	ZETEX	BD	$V_R < 25B$; $C_{2V} = 100 \pm 20\% \text{ пФ}$; $C_{2V}/C_{20V} = 5 \dots 6.5$; $Q > 100$	A	nc	K
J8	BCX71JR	ZETEX	PNP	$V_{CB0} = -45B$; $I_C = -200 \text{ mA}$; $P_D = 330 \text{ мВт}$; $h_{21} = 250 \dots 460$; $f_T > 180 \text{ МГц}$	B	E	C
J9	SST109	SIL	nFET	$V_{DS} = 25B$; $P_D = 350 \text{ мВт}$; $I_{DSS} > 40 \text{ mA}$; $g_f = 17 \text{ мСм}$; $R_{DS(on)} = 120 \text{ м}$	D	S	G
JA	BAV74	ALLEG	2xD	$I_F < 70 \text{ mA}$; $V_{BR} > 50B$; $V_F(I_F = 100 \text{ mA}) < 1.0B$; $I_R < 100 \text{ нА}$; $t_{RR} < 4.0 \text{ нс}$; $C_D < 2.0 \text{ пФ}$	A1	A2	K1 K2
JA	BAV74	ZETEX	2xFD	$V_R < 50B$; $I_F < 150 \text{ mA}$; $V_F(I_F = 100 \text{ mA}) < 1.0B$; $I_R < 0.1 \text{ мкА}$; $C_D < 2 \text{ пФ}$; $t_{RR} < 4 \text{ нс}$	A1	A2	K1 A2
JAp	BAV74	PHIL	2xFD	$V_R < 50B$; $I_F < 215 \text{ mA}$; $V_F(I_F = 100 \text{ mA}) < 1.0B$; $C_D < 2.0 \text{ пФ}$; $t_{RR} < 4 \text{ нс}$	A1	A2	K1 K2
JAs	BAV74	SIEM	2xDI	$V_R < 50B$; $I_F < 200 \text{ mA}$; $V_F(I_F = 100 \text{ mA}) < 1.0B$; $I_R < 0.1 \text{ мкА}$; $C_D < 2.0 \text{ пФ}$; $t_{RR} < 4 \text{ нс}$	A1	A2	K1 A2
JB	BAR74	ZETEX	DI	$V_R < 50B$; $I_F < 150 \text{ mA}$; $V_F(I_F = 100 \text{ mA}) < 1.0B$; $I_R < 0.1 \text{ мкА}$; $C_D < 2.0 \text{ пФ}$; $t_{RR} < 4 \text{ нс}$	A	nc	K
JBs	BAR74	SIEM	DI	$V_R < 50B$; $I_F < 250 \text{ mA}$; $V_F(I_F = 100 \text{ mA}) < 1.0B$; $I_R < 0.1 \text{ мкА}$; $C_D < 2 \text{ пФ}$; $t_{RR} < 4 \text{ нс}$	A	nc	K
JC	BAL74	ZETEX	DI	$V_R < 50B$; $I_F < 150 \text{ mA}$; $V_F(I_F = 100 \text{ mA}) < 1.0B$; $I_R < 0.1 \text{ мкА}$; $C_D < 2 \text{ пФ}$; $t_{RR} < 4 \text{ нс}$	nc	A	K
JCp	BAL74	PHIL	FD	$V_R < 50B$; $I_F < 215 \text{ mA}$; $V_F(I_F = 50 \text{ mA}) < 1.0B$; $C_D < 2 \text{ пФ}$; $t_{RR} < 4 \text{ нс}$	nc	A	K
JCs	BAL74	SIEM	DI	$V_R < 50B$; $I_F < 250 \text{ mA}$; $V_F(I_F = 100 \text{ mA}) < 1.0B$; $I_R < 0.1 \text{ мкА}$; $C_D < 2 \text{ пФ}$; $t_{RR} < 4 \text{ нс}$	nc	A	K
JD	BAW56	VISH	2xDI	$V_R < 70B$; $I_F < 300 \text{ mA}$; $V_F(I_F = 150 \text{ mA}) < 1.25B$; $I_R < 5.0 \text{ мкА}$; $C_D < 4.0 \text{ пФ}$; $t_{RR} < 6 \text{ нс}$	K1	K2	A1 A2
JE	BAV99	VISH	2xDI	$V_R < 70B$; $I_F < 300 \text{ mA}$; $V_F(I_F = 150 \text{ mA}) < 1.25B$; $I_R < 5.0 \text{ мкА}$; $C_D < 4.0 \text{ пФ}$; $t_{RR} < 6 \text{ нс}$	A1	K2	K1 A2
JF	BAL99	GS	SHD	$V_R = 100B$; $I_F = 300 \text{ mA}$; $P_D = 350 \text{ мВт}$; $t_{RR} < 6 \text{ нс}$	nc	K	A
JF	BAL99	VISH	DI	$V_R < 70B$; $I_F < 250 \text{ mA}$; $V_F(I_F = 50 \text{ mA}) < 1.0B$; $I_R < 2.5 \text{ мкА}$; $C_D < 1.5 \text{ пФ}$; $t_{RR} < 6 \text{ нс}$	nc	K	A
JFp	BAL99	PHIL	FD	$V_R < 70B$; $I_F < 250 \text{ mA}$; $V_F(I_F = 50 \text{ mA}) < 1.0B$; $C_D < 1.5 \text{ пФ}$; $t_{RR} < 6 \text{ нс}$	nc	K	A
JFs	BAL99	SIEM	DI	$V_R < 70B$; $I_F < 250 \text{ mA}$; $V_F(I_F = 50 \text{ mA}) < 1.0B$; $I_R < 2.5 \text{ мкА}$; $C_D < 1.5 \text{ пФ}$; $t_{RR} < 6 \text{ нс}$	nc	K	A
JGs	BAR99	SIEM	DI	$V_R < 70B$; $I_F < 250 \text{ mA}$; $V_F(I_F = 50 \text{ mA}) < 1.0B$; $I_R < 2.5 \text{ мкА}$; $C_D < 1.5 \text{ пФ}$; $t_{RR} < 6 \text{ нс}$	K	nc	A
JJ	BAV70	VISH	2xDI	$V_R < 70B$; $I_F < 300 \text{ mA}$; $V_F(I_F = 150 \text{ mA}) < 1.25B$; $I_R < 5.0 \text{ мкА}$; $C_D < 4.0 \text{ пФ}$; $t_{RR} < 6 \text{ нс}$	A1	A2	K1 A2
JPp	BAS19	PHIL	FD	$V_R < 100B$; $I_F < 200 \text{ mA}$; $V_F(I_F = 100 \text{ mA}) < 1.0B$; $C_D < 5 \text{ пФ}$; $t_{RR} < 50 \text{ нс}$	A	nc	K
JPs	BAS19	SIEM	DI	$V_R < 100B$; $I_F < 250 \text{ mA}$; $V_F(I_F = 100 \text{ mA}) < 1.0B$; $I_R < 0.1 \text{ мкА}$; $C_D < 5.0 \text{ пФ}$; $t_{RR} < 50 \text{ нс}$	A	nc	K
JRp	BAS20	PHIL	FD	$V_R < 150B$; $I_F < 200 \text{ mA}$; $V_F(I_F = 100 \text{ mA}) < 1.0B$; $C_D < 5 \text{ пФ}$; $t_{RR} < 50 \text{ нс}$	A	nc	K
JRs	BAS20	SIEM	DI	$V_R < 150B$; $I_F < 250 \text{ mA}$; $V_F(I_F = 100 \text{ mA}) < 1.0B$; $I_R < 0.1 \text{ мкА}$; $C_D < 5.0 \text{ пФ}$; $t_{RR} < 50 \text{ нс}$	A	nc	K
JSp	BAS21	PHIL	FD	$V_R < 200B$; $I_F < 200 \text{ mA}$; $V_F(I_F = 100 \text{ mA}) < 1.0B$; $C_D < 5 \text{ пФ}$; $t_{RR} < 50 \text{ нс}$	A	nc	K
JSs	BAS21	SIEM	DI	$V_R < 200B$; $I_F < 250 \text{ mA}$; $V_F(I_F = 100 \text{ mA}) < 1.0B$; $I_R < 0.1 \text{ мкА}$; $C_D < 5.0 \text{ пФ}$; $t_{RR} < 50 \text{ нс}$	A	nc	K
JVp	BAS116	PHIL	DL	$V_R < 75B$; $I_F < 215 \text{ mA}$; $V_F(I_F = 10 \text{ mA}) < 1.0B$; $I_R(V_R = 75B) < 5 \text{ нА}$; $C_D < 2 \text{ пФ}$; $t_{RR} < 3000 \text{ нс}$	A	nc	K

SOT23, SOD23 (продолжение)

Код	Типономинал	Фирма	Функция	Особенности	Цоколевка		
					1	2	3
JVs	BAS116	SIEM	DL	$V_R < 75B; I_F < 250_{MA}; V_F(I_F = 50_{MA}) < 1.1B; I_R < 5.0_{мкА}; C_D < 2.0_{пФ}; t_{RR} < 3000_{нс}$	A	nc	K
JXp	BAV170	PHIL	2xDL	$V_R < 75B; I_F < 215_{MA}; V_F(I_F = 10_{MA}) < 1.0B; I_R(V_R = 75B) < 5_{HA}; C_D < 2_{пФ}; t_{RR} < 3000_{нс}$	A1	A2	K1 A2
JXs	BAV170	SIEM	2xDL	$V_R < 70B; I_F < 200_{MA}; V_F(I_F = 150_{MA}) < 1.25B; I_R < 0.005_{мкА}; C_D < 2.0_{пФ}; t_{RR} < 3000_{нс}$	A1	A2	K1 A2
JYp	BAV199	PHIL	2xDL	$V_R < 75B; I_F < 160_{MA}; V_F(I_F = 10_{MA}) < 1.0B; I_R(V_R = 75B) < 5_{HA}; C_D < 2_{пФ}; t_{RR} < 3000_{нс}$	A1	K2	K1 A2
JYs	BAV199	SIEM	2xDL	$V_R < 70B; I_F < 200_{MA}; V_F(I_F = 150_{MA}) < 1.25B; I_R < 0.005_{мкА}; C_D < 2.0_{пФ}; t_{RR} < 3000_{нс}$	A1	K2	K1 A2
JZp	BAW156	PHIL	2xDL	$V_R < 75B; I_F < 160_{MA}; V_F(I_F = 10_{MA}) < 1.0B; I_R(V_R = 75B) < 5_{HA}; C_D < 3_{пФ}; t_{RR} < 3000_{нс}$	K1	K2	A1 A2
JZs	BAW156	SIEM	2xDL	$V_R < 70B; I_F < 200_{MA}; V_F(I_F = 150_{MA}) < 1.25B; I_R < 0.005_{мкА}; C_D < 2.0_{пФ}; t_{RR} < 3000_{нс}$	K1	K2	A1 A2
KO	HSMP-3830	HP	PIN	$I_F < 1A; V_{BR} > 200B; R_S < 1.5_{\Omega}; C_D < 0.3_{пФ}$	A	nc	K
K1	BCW71	ALLEG	NPN	$V_{CB0} = -50B; I_{CB0} < 100_{HA}; h_{21} = 110...220; V_{CE(sat)} < 0.25B$	B	E	C
K1	BCW71	CDIL	NPN	$V_{CB0} = 50B; I_C = -100_{MA}; P_D = 250_{мВт}; h_{21} = 110...220; f_T > 100_{МГц}$	B	E	C
K1	BCW71	SAMS	NPN	$V_{CB0} = 50B; I_C = -100_{MA}; P_D = 350_{мВт}; h_{21} = 120...220; f_T > 300_{МГц}$	B	E	C
K1	VN10KT	SIL	nMOS	$V_{DS} = 60B; I_D = 310_{MA}; P_D = 1000_{мВт}; g_f = 100_{мСм}; R_{DS(on)} = 7.5_{\Omega}$	G	S	D
K1	BCW71	ZETEX	NPN	$V_{CB0} = 50B; I_C = -100_{MA}; P_D = 330_{мВт}; h_{21} = 110...220; f_T > 300_{МГц}$	B	E	C
K1N	MMBT3904	VISH	NPN	$V_{CB0} = 60B; I_C = -100_{MA}; P_D = 200_{мВт}; h_{21} = 100...300; f_T > 300_{МГц}$	B	E	C
K1O	KSA3265	SAMS	NPN	$V_{CB0} = 30B; I_C = 800_{MA}; P_D = 200_{мВт}; h_{21} = 100...200; f_T > 120_{МГц}$	B	E	C
K1p	BCW71	PHIL	NPN	$V_{CB0} = 50B; I_C = -100_{MA}; P_D = 250_{мВт}; h_{21} = 110...220; f_T > 100_{МГц}$	B	E	C
K1P	MMBT2222A	VISH	NPN	$V_{CB0} = 50B; I_C = -800_{MA}; P_D = 200_{мВт}; h_{21} = 100...300; f_T > 200_{МГц}$	B	E	C
K1Y	KSA3265	SAMS	NPN	$V_{CB0} = 30B; I_C = -800_{MA}; P_D = 200_{мВт}; h_{21} = 160...320; f_T > 120_{МГц}$	B	E	C
K2	BCW72	ALLEG	NPN	$V_{CB0} = -50B; I_{CB0} < 100_{HA}; h_{21} = 200...450; V_{CE(sat)} < 0.25B$	B	E	C
K2	BCW72	CDIL	NPN	$V_{CB0} = 50B; I_C = -100_{MA}; P_D = 250_{мВт}; h_{21} = 200...450; f_T > 100_{МГц}$	B	E	C
K2	HSMP-3832	HP	2xPIN	$I_F < 1A; V_{BR} > 200B; R_S < 1.5_{\Omega}; C_D < 0.3_{пФ};$	A1	K2	K1 A2
K2	BCW72	ZETEX	NPN	$V_{CB0} = 50B; I_C = -100_{MA}; P_D = 330_{мВт}; h_{21} = 200...450; f_T > 300_{МГц}$	B	E	C
K2F	MMBT2907	VISH	PNP	$V_{CB0} = -40B; I_C = -500_{MA}; P_D = 310_{мВт}; h_{21} = 100...300; f_T > 200_{МГц}$	B	E	C
K2p	BCW72	PHIL	NPN	$V_{CB0} = 50B; I_C = -100_{MA}; P_D = 250_{мВт}; h_{21} = 200...450; f_T > 100_{МГц}$	B	E	C
K2T	MMBT4403	VISH	PNP	$V_{CB0} = -40B; I_C = -800_{MA}; P_D = 200_{мВт}; h_{21} = 100...300; f_T > 200_{МГц}$	B	E	C
K2X	MMBT4401	VISH	NPN	$V_{CB0} = 50B; I_C = 800_{MA}; P_D = 200_{мВт}; h_{21} = 100...300; f_T > 200_{МГц}$	B	E	C
K3	BCW81	CDIL	NPN	$V_{CB0} = 50B; I_C = -100_{MA}; P_D = 250_{мВт}; h_{21} = 420...800; f_T > 100_{МГц}$	B	E	C
K3	HSMP-3833	HP	2xPIN	$I_F < 1A; V_{BR} > 200B; R_S < 1.5_{\Omega}; C_D < 0.3_{пФ};$	K1	K2	A1 A2
K31	BCW81R	PHIL	NPN	$V_{CB0} = 50B; I_C = -100_{MA}; P_D = 350_{мВт}; h_{21} = 420...800; f_T > 300_{МГц}$	E	B	C
K3A	KDV804S	KEC	2xBD	$V_R = 15B; I_R = 50_{HA}; C_{2V} = 42.7_{пФ}; C_{8V} = 25_{пФ}; r_s < 0.3_{\Omega}$	A1	A2	K1 K2
K3B	KDV804S	KEC	2xBD	$V_R = 15B; I_R = 50_{HA}; C_{2V} = 43.7_{пФ}; C_{8V} = 25_{пФ}; r_s < 0.3_{\Omega}$	A1	A2	K1 K2
K3C	KDV804S	KEC	2xBD	$V_R = 15B; I_R = 50_{HA}; C_{2V} = 44.7_{пФ}; C_{8V} = 25_{пФ}; r_s < 0.3_{\Omega}$	A1	A2	K1 K2
K3D	KDV804S	KEC	2xBD	$V_R = 15B; I_R = 50_{HA}; C_{2V} = 45.7_{пФ}; C_{8V} = 25_{пФ}; r_s < 0.3_{\Omega}$	A1	A2	K1 K2
K3E	KDV804S	KEC	2xBD	$V_R = 15B; I_R = 50_{HA}; C_{2V} = 46.7_{пФ}; C_{8V} = 25_{пФ}; r_s < 0.3_{\Omega}$	A1	A2	K1 K2
K3N	MMBT3906	VISH	PNP	$V_{CB0} = -40B; I_C = -100_{MA}; P_D = 200_{мВт}; h_{21} = 100...300; f_T > 250_{МГц}$	B	E	C
K3p	BCW81	PHIL	NPN	$V_{CB0} = 50B; I_C = -100_{MA}; P_D = 350_{мВт}; h_{21} = 420...800; f_T > 300_{МГц}$	B	E	C
K4	HSMP-3834	HP	2xPIN	$I_F < 1A; V_{BR} > 200B; R_S < 1.5_{\Omega}; C_D < 0.3_{пФ};$	A1	A2	K1 K2

SOT23, SOD23 (продолжение)

Код	Типономинал	Фирма	Функция	Особенности	Цоколевка		
					1	2	3
K4	BCW71R	PHIL	NPN	$V_{CB0}=45B; I_C=-100mA; P_D=350mBт; h_{21}=110...220; f_T>100MГц$	E	B	C
K4	BCW71R	ZETEX	NPN	$V_{CB0}=50B; I_C=-100mA; P_D=330mBт; h_{21}=110...220; f_T>300MГц$	B	E	C
K5	BCW72R	PHIL	NPN	$V_{CB0}=45B; I_C=-100mA; P_D=350mBт; h_{21}=200...450; f_T>100MГц$	E	B	C
K5	BCW72R	ZETEX	NPN	$V_{CB0}=50B; I_C=-100mA; P_D=330mBт; h_{21}=200...450; f_T>300MГц$	B	E	C
K6	BCV71R	ZETEX	NPN	$V_{CB0}=80B; I_C=-100mA; P_D=330mBт; h_{21}=110...220; f_T>300MГц$	B	E	C
K7	BCV71	CDIL	NPN	$V_{CB0}=80B; I_C=-100mA; P_D=330mBт; h_{21}=110...220; f_T>300MГц$	B	E	C
K7	BCV71	ZETEX	NPN	$V_{CB0}=80B; I_C=-100mA; P_D=330mBт; h_{21}=110...220; f_T>300MГц$	B	E	C
K7p	BCV71	PHIL	NPN	$V_{CB0}=80B; I_C=-100mA; P_D=250mBт; h_{21}=110...220; f_T>100MГц$	B	E	C
K8	BCV72	CDIL	NPN	$V_{CB0}=80B; I_C=-100mA; P_D=330mBт; h_{21}=200...450; f_T>300MГц$	B	E	C
K8	BCV72	ZETEX	NPN	$V_{CB0}=80B; I_C=-100mA; P_D=330mBт; h_{21}=200...450; f_T>300MГц$	B	E	C
K8p	BCV72	PHIL	NPN	$V_{CB0}=80B; I_C=-100mA; P_D=250mBт; h_{21}=200...450; f_T>100MГц$	B	E	C
K8	BCV72R	ZETEX	NPN	$V_{CB0}=80B; I_C=-100mA; P_D=330mBт; h_{21}=200...450; f_T>300MГц$	B	E	C
K91	BCF81R	PHIL	NPN	$V_{CB0}=45B; I_C=-100mA; P_D=350mBт; h_{21}=420...800; f_T>100MГц$	E	B	C
K9p	BCF81	PHIL	NPN	$V_{CB0}=50B; I_C=-100mA; P_D=250mBт; h_{21}=420...800; f_T>100MГц$	B	E	C
KA2	MMBD4148	VISH	DI	$V_R<75B; I_F<300mA; V_F(I_F=10mA)<1.0B; I_R<5.0мкA; C_D<4пФ; t_{RR}<6нс$	A	nc	K
KA3	MMBD4448	VISH	FID	$V_R<75B; I_F<500mA; V_F(I_F=100mA)<1.0B; I_R<5.0мкA; C_D<4пФ; t_{RR}<4нс$	A	nc	K
KA6	BAS16	VISH	FID	$V_R<75B; I_F<500mA; V_F(I_F=150mA)<1.25B; I_R<1.0мкA; C_D<4.0пФ; t_{RR}<4нс$	A	nc	K
KC	BFQ29P	SIEM	NPN	$V_{CB0}=20B; I_C=-30mA; P_D=280mBт; h_{21}=50...250; f_T=5000MГц$	B	E	C
KD1	AZ23C2V7	VISH	2xDZ	$V_Z=2.5...2.9B; R_Z(I_Z=5mA)=830M$	K1	K2	A1 A2
KD2	AZ23C3	VISH	2xDZ	$V_Z=2.8...3.2B; R_Z(I_Z=5mA)=950M$	K1	K2	A1 A2
KD3	AZ23C3V3	VISH	2xDZ	$V_Z=3.1...3.5B; R_Z(I_Z=5mA)=950M$	K1	K2	A1 A2
KD4	AZ23C3V6	VISH	2xDZ	$V_Z=3.4...3.8B; R_Z(I_Z=5mA)=950M$	K1	K2	A1 A2
KD5	AZ23C3V9	VISH	2xDZ	$V_Z=3.7...4.1B; R_Z(I_Z=5mA)=950M$	K1	K2	A1 A2
KD6	AZ23C4V3	VISH	2xDZ	$V_Z=4.0...4.6B; R_Z(I_Z=5mA)=950M$	K1	K2	A1 A2
KD7	AZ23C4V7	VISH	2xDZ	$V_Z=4.4...5.0B; R_Z(I_Z=5mA)=780M$	K1	K2	A1 A2
KD8	AZ23C5V1	VISH	2xDZ	$V_Z=4.8...5.4B; R_Z(I_Z=5mA)=600M$	K1	K2	A1 A2
KD9	AZ23C5V6	VISH	2xDZ	$V_Z=5.2...6.0B; R_Z(I_Z=5mA)=400M$	K1	K2	A1 A2
KDA	AZ23C6V2	VISH	2xDZ	$V_Z=5.8...6.6B; R_Z(I_Z=5mA)=100M$	K1	K2	A1 A2
KDB	AZ23C6V8	VISH	2xDZ	$V_Z=6.4...7.2B; R_Z(I_Z=5mA)=80M$	K1	K2	A1 A2
KDC	AZ23C7V5	VISH	2xDZ	$V_Z=7.0...7.9B; R_Z(I_Z=5mA)=70M$	K1	K2	A1 A2
KDD	AZ23C8V2	VISH	2xDZ	$V_Z=7.7...8.7B; R_Z(I_Z=5mA)=70M$	K1	K2	A1 A2
KDE	AZ23C9V1	VISH	2xDZ	$V_Z=8.5...9.6B; R_Z(I_Z=5mA)=100M$	K1	K2	A1 A2
KDF	AZ23C10	VISH	2xDZ	$V_Z=9.4...10.6B; R_Z(I_Z=5mA)=150M$	K1	K2	A1 A2
KDG	AZ23C11	VISH	2xDZ	$V_Z=10.4...11.6B; R_Z(I_Z=5mA)=200M$	K1	K2	A1 A2
KDH	AZ23C12	VISH	2xDZ	$V_Z=11.4...12.7B; R_Z(I_Z=5mA)=200M$	K1	K2	A1 A2

SOT23, SOD23 (продолжение)

Код	Типономинал	Фирма	Функция	Особенности	Цоколевка		
					1	2	3
KDI	AZ23C13	VISH	2xDZ	$V_Z=12.4...14.1B; R_Z(I_Z=5_{MA})=250M$	K1	K2	A1 A2
KDJ	AZ23C15	VISH	2xDZ	$V_Z=13.8...15.6B; R_Z(I_Z=5_{MA})=300M$	K1	K2	A1 A2
KDK	AZ23C16	VISH	2xDZ	$V_Z=15.3...17.1B; R_Z(I_Z=5_{MA})=400M$	K1	K2	A1 A2
KDL	AZ23C18	VISH	2xDZ	$V_Z=16.8...19.1B; R_Z(I_Z=5_{MA})=500M$	K1	K2	A1 A2
KDM	AZ23C20	VISH	2xDZ	$V_Z=18.8...21.2B; R_Z(I_Z=5_{MA})=500M$	K1	K2	A1 A2
KDN	AZ23C22	VISH	2xDZ	$V_Z=20.8...23.3B; R_Z(I_Z=5_{MA})=550M$	K1	K2	A1 A2
KDO	AZ23C24	VISH	2xDZ	$V_Z=22.8...25.6B; R_Z(I_Z=5_{MA})=800M$	K1	K2	A1 A2
KDP	AZ23C27	VISH	2xDZ	$V_Z=25.1...28.9B; R_Z(I_Z=5_{MA})=800M$	K1	K2	A1 A2
KDQ	AZ23C30	VISH	2xDZ	$V_Z=28...32B; R_Z(I_Z=5_{MA})=800M$	K1	K2	A1 A2
KDR	AZ23C33	VISH	2xDZ	$V_Z=31...35B; R_Z(I_Z=5_{MA})=800M$	K1	K2	A1 A2
KDS	AZ23C36	VISH	2xDZ	$V_Z=34...38B; R_Z(I_Z=5_{MA})=900M$	K1	K2	A1 A2
KDT	AZ23C39	VISH	2xDZ	$V_Z=37...41B; R_Z(I_Z=5_{MA})=900M$	K1	K2	A1 A2
KJD	BAW56	VISH	2xDI	$V_R<70B; I_F<300_{MA}; V_F(I_F=150_{MA})<1.25B; I_R<5.0_{мкА}; C_D<4.0_{пФ}; t_{RR}<6_{нс}$	K1	K2	A1 A2
KJE	BAV99	VISH	2xDI	$V_R<70B; I_F<300_{MA}; V_F(I_F=150_{MA})<1.25B; I_R<5.0_{мкА}; C_D<4.0_{пФ}; t_{RR}<6_{нс}$	A1	K2	K1 A2
KJF	BAL99	VISH	DI	$V_R<70B; I_F<250_{MA}; V_F(I_F=150_{MA})<1.0B; I_R<2.5_{мкА}; C_D<1.5_{пФ}; t_{RR}<6_{нс}$	nc	K	A
KJJ	BAV70	VISH	2xDI	$V_R<70B; I_F<300_{MA}; V_F(I_F=150_{MA})<1.25B; I_R<5.0_{мкА}; C_D<4.0_{пФ}; t_{RR}<6_{нс}$	A1	A2	K1 K2
KL1	BAT54	VISH	SHD	$V_R<30B; I_F<200_{MA}; V_F(I_F=100_{MA})<1.0B; I_R<2_{мкА}; C_D<10_{пФ}; t_{RR}<5_{нс}$	A	nc	K
KL2	BAT54A	VISH	2XSHD	$V_R<30B; I_F<200_{MA}; V_F(I_F=100_{MA})<1.0B; I_R<2.0_{мкА}; C_D<10_{пФ}; t_{RR}<5_{нс}$	K1	K2	A1 A2
KL2	BAS54A	VISH	2XSHD	$V_R=30B; I_F=200_{MA}; PD=200_{мВт}; t_{RR}<5_{нс}$	K1	K2	A1 A2
KL3	BAT54B	VISH	2XSHD	$V_R<30B; I_F<200_{MA}; V_F(I_F=100_{MA})<1.0B; I_R<2.0_{мкА}; C_D<10_{пФ}; t_{RR}<5_{нс}$	A1	A2	K1 K2
KL3	BAS54C	VISH	2XSHD	$V_R=30B; I_F=200_{MA}; PD=200_{мВт}; t_{RR}<5_{нс}$	A1	A2	K1 K2
KL4	BAT54S	VISH	2XSHD	$V_R<30B; I_F<200_{MA}; V_F(I_F=100_{MA})<1.0B; I_R<2.0_{мкА}; C_D<10_{пФ}; t_{RR}<5_{нс}$	A1	K2	K1 A2
KL4	BAS54C	VISH	2XSHD	$V_R=30B; I_F=200_{MA}; PD=200_{мВт}; t_{RR}<5_{нс}$	A1	K2	K1 A2
KV1	DZ23C2V7	VISH	2xDZ	$V_Z=2.5...2.9B; Z_{ZT}(I_Z=5_{MA})=830M$	A1	A2	K1 K2
KV2	DZ23C3V0	VISH	2xDZ	$V_Z=2.8...3.2B; Z_{ZT}(I_Z=5_{MA})=950M$	A1	A2	K1 K2
KV3	DZ23C3V3	VISH	2xDZ	$V_Z=3.1...3.5B; Z_{ZT}(I_Z=5_{MA})=950M$	A1	A2	K1 K2
KV4	DZ23C3V6	VISH	2xDZ	$V_Z=3.4...3.8B; Z_{ZT}(I_Z=5_{MA})=950M$	A1	A2	K1 K2
KV5	DZ23C3V9	VISH	2xDZ	$V_Z=3.7...4.1B; Z_{ZT}(I_Z=5_{MA})=950M$	A1	A2	K1 K2
KV6	DZ23C4V3	VISH	2xDZ	$V_Z=4.0...4.6B; Z_{ZT}(I_Z=5_{MA})=950M$	A1	A2	K1 K2
KV7	DZ23CV7	VISH	2xDZ	$V_Z=4.4...5.0B; Z_{ZT}(I_Z=5_{MA})=780M$	A1	A2	K1 K2
KV8	DZ23C5V1	VISH	2xDZ	$V_Z=4.8...5.4B; Z_{ZT}(I_Z=5_{MA})=600M$	A1	A2	K1 K2
KV9	DZ23C5V6	VISH	2xDZ	$V_Z=5.2...6.0B; Z_{ZT}(I_Z=5_{MA})=400M$	A1	A2	K1 K2
KVA	DZ23C6V2	VISH	2xDZ	$V_Z=5.8...6.6B; Z_{ZT}(I_Z=5_{MA})=100M$	A1	A2	K1 K2
KVB	DZ23C6V8	VISH	2xDZ	$V_Z=6.4...7.2B; Z_{ZT}(I_Z=5_{MA})=80M$	A1	A2	K1 K2
KVC	DZ23C7V5	VISH	2xDZ	$V_Z=7.0...7.9B; Z_{ZT}(I_Z=5_{MA})=70M$	A1	A2	K1 K2

SOT23, SOD23 (продолжение)

Код	Типономинал	Фирма	Функция	Особенности	Цоколевка		
					1	2	3
KVD	DZ23C8V2	VISH	2xDZ	$V_z=7.7...8.7B; Z_{ZI}(I_z=5mA)=70M$	A1	A2	K1 K2
KVF	DZ23C10	VISH	2xDZ	$V_z=9.4...10B; Z_{ZI}(I_z=5mA)=150M$	A1	A2	K1 K2
KVG	DZ23C11	VISH	2xDZ	$V_z=10.4...11B; Z_{ZI}(I_z=5mA)=200M$	A1	A2	K1 K2
KVH	DZ23C12	VISH	2xDZ	$V_z=11.4...12B; Z_{ZI}(I_z=5mA)=200M$	A1	A2	K1 K2
KVI	DZ23C13	VISH	2xDZ	$V_z=12.4...14B; Z_{ZI}(I_z=5mA)=250M$	A1	A2	K1 K2
KVJ	DZ23C15	VISH	2xDZ	$V_z=13.8...15B; Z_{ZI}(I_z=5mA)=300M$	A1	A2	K1 K2
KVK	DZ23C16	VISH	2xDZ	$V_z=15.3...17B; Z_{ZI}(I_z=5mA)=400M$	A1	A2	K1 K2
KVG	DZ23C11	VISH	2xDZ	$V_z=10.4...11B; Z_{ZI}(I_z=5mA)=200M$	A1	A2	K1 K2
KVL	DZ23C18	VISH	2xDZ	$V_z=16.8...19B; Z_{ZI}(I_z=5mA)=500M$	A1	A2	K1 K2
KVM	DZ23C20	VISH	2xDZ	$V_z=18.8...21B; Z_{ZI}(I_z=5mA)=500M$	A1	A2	K1 K2
KVN	DZ23C22	VISH	2xDZ	$V_z=20.8...23B; Z_{ZI}(I_z=5mA)=550M$	A1	A2	K1 K2
KVO	DZ23C24	VISH	2xDZ	$V_z=22.8...25B; Z_{ZI}(I_z=5mA)=800M$	A1	A2	K1 K2
KVP	DZ23C27	VISH	2xDZ	$V_z=25.1...28B; Z_{ZI}(I_z=2mA)=800M$	A1	A2	K1 K2
KVQ	DZ23C30	VISH	2xDZ	$V_z=28...32B; Z_{ZI}(I_z=2mA)=800M$	A1	A2	K1 K2
KVR	DZ23C33	VISH	2xDZ	$V_z=31...35B; Z_{ZI}(I_z=2mA)=800M$	A1	A2	K1 K2
KVS	DZ23C36	VISH	2xDZ	$V_z=34...38B; Z_{ZI}(I_z=2mA)=900M$	A1	A2	K1 K2
KVT	DZ23C39	VISH	2xDZ	$V_z=37...41B; Z_{ZI}(I_z=2mA)=900M$	A1	A2	K1 K2
KVU	DZ23C43	VISH	2xDZ	$V_z=40...46B; Z_{ZI}(I_z=2mA)=1000M$	A1	A2	K1 K2
KVV	DZ23C47	VISH	2xDZ	$V_z=44...50B; Z_{ZI}(I_z=2mA)=1000M$	A1	A2	K1 K2
KVW	DZ23C51	VISH	2xDZ	$V_z=48...54B; Z_{ZI}(I_z=5mA)=1000M$	A1	A2	K1 K2
KY1	BZX84C11	VISH	DZ	$V_z(I_{ZI}=5mA)=10.4...11.6B; Z_{ZI}(I_{ZI}=5mA)<200M$	A	nc	K
KY2	BZX84C12	VISH	DZ	$V_z(I_{ZI}=5mA)=11.4...12.7B; Z_{ZI}(I_{ZI}=5mA)<250M$	A	nc	K
KY3	BZX84C13	VISH	DZ	$V_z(I_{ZI}=5mA)=12.4...14.1B; Z_{ZI}(I_{ZI}=5mA)<300M$	A	nc	K
KY4	BZX84C15	VISH	DZ	$V_z(I_{ZI}=5mA)=13.8...15.6B; Z_{ZI}(I_{ZI}=5mA)<300M$	A	nc	K
KY5	BZX84C16	VISH	DZ	$V_z(I_{ZI}=5mA)=15.3...17.1B; Z_{ZI}(I_{ZI}=5mA)<400M$	A	nc	K
KY6	BZX84C18	VISH	DZ	$V_z(I_{ZI}=5mA)=16.8...19.1B; Z_{ZI}(I_{ZI}=5mA)<450M$	A	nc	K
KY7	BZX84C20	VISH	DZ	$V_z(I_{ZI}=5mA)=18.8...21.2B; Z_{ZI}(I_{ZI}=5mA)<550M$	A	nc	K
KY8	BZX84C22	VISH	DZ	$V_z(I_{ZI}=5mA)=20.8...23.3B; Z_{ZI}(I_{ZI}=5mA)<550M$	A	nc	K
KY9	BZX84C24	VISH	DZ	$V_z(I_{ZI}=5mA)=22.8...25.6B; Z_{ZI}(I_{ZI}=5mA)<700M$	A	nc	K
KYA	BZX84C27	VISH	DZ	$V_z(I_{ZI}=5mA)=25.1...28.9B; Z_{ZI}(I_{ZI}=2mA)<800M$	A	nc	K
KYB	BZX84C30	VISH	DZ	$V_z(I_{ZI}=5mA)=28.0...32.0B; Z_{ZI}(I_{ZI}=2mA)<800M$	A	nc	K
KYC	BZX84C33	VISH	DZ	$V_z(I_{ZI}=5mA)=31.0...35.0B; Z_{ZI}(I_{ZI}=2mA)<800M$	A	nc	K
KYD	BZX84C36	VISH	DZ	$V_z(I_{ZI}=5mA)=33.0...38.0B; Z_{ZI}(I_{ZI}=2mA)<900M$	A	nc	K
KYE	BZX84C39	VISH	DZ	$V_z(I_{ZI}=5mA)=36.0...41.0B; Z_{ZI}(I_{ZI}=2mA)<1300M$	A	nc	K
KYF	BZX84C43	VISH	DZ	$V_z(I_{ZI}=5mA)=40.0...46.0B; Z_{ZI}(I_{ZI}=2mA)<1500M$	A	nc	K
KYG	BZX84C47	VISH	DZ	$V_z(I_{ZI}=5mA)=44.0...50.0B; Z_{ZI}(I_{ZI}=2mA)<1700M$	A	nc	K
KYH	BZX84C51	VISH	DZ	$V_z(I_{ZI}=5mA)=48.1...54.0B; Z_{ZI}(I_{ZI}=2mA)<1800M$	A	nc	K
KZ1	BZX84C4V7	VISH	DZ	$V_z(I_{ZI}=5mA)=4.4...5.0B; Z_{ZI}(I_{ZI}=5mA)<800M$	A	nc	K
KZ2	BZX84C5V1	VISH	DZ	$V_z(I_{ZI}=5mA)=4.8...5.4B; Z_{ZI}(I_{ZI}=5mA)<600M$	A	nc	K
KZ3	BZX84C5V6	VISH	DZ	$V_z(I_{ZI}=5mA)=5.2...6.0B; Z_{ZI}(I_{ZI}=5mA)<400M$	A	nc	K
KZ4	BZX84C6V2	VISH	DZ	$V_z(I_{ZI}=5mA)=5.8...6.6B; Z_{ZI}(I_{ZI}=5mA)<100M$	A	nc	K
KZ5	BZX84C6V8	VISH	DZ	$V_z(I_{ZI}=5mA)=6.4...7.2B; Z_{ZI}(I_{ZI}=5mA)<150M$	A	nc	K
KZ6	BZX84C7V5	VISH	DZ	$V_z(I_{ZI}=5mA)=7.0...7.9B; Z_{ZI}(I_{ZI}=5mA)<150M$	A	nc	K
KZ7	BZX84C8V2	VISH	DZ	$V_z(I_{ZI}=5mA)=7.7...8.9B; Z_{ZI}(I_{ZI}=5mA)<150M$	A	nc	K
KZ8	BZX84C9V1	VISH	DZ	$V_z(I_{ZI}=5mA)=8.5...9.6B; Z_{ZI}(I_{ZI}=5mA)<150M$	A	nc	K
KZ9	BZX84C10	VISH	DZ	$V_z(I_{ZI}=5mA)=9.4...10.6B; Z_{ZI}(I_{ZI}=5mA)<200M$	A	nc	K
KZC	BZX84C2V7	VISH	DZ	$V_z(I_{ZI}=5mA)=2.51...2.89B; Z_{ZI}(I_{ZI}=5mA)<1000M$	A	nc	K
KZD	BZX84C3V0	VISH	DZ	$V_z(I_{ZI}=5mA)=2.8...3.2B; Z_{ZI}(I_{ZI}=5.0mA)<100M$	A	nc	K

SOT23, SOD23 (продолжение)

Код	Типономинал	Фирма	Функция	Особенности	Цоколевка		
					1	2	3
KZE	BZX84C3V3	VISH	DZ	$V_Z(I_{ZT}=5_{MA})=3.1...3.5B; Z_{ZT}(I_{ZT}=5_{MA})<95OM$	A	nc	K
KZF	BZX84C3V6	VISH	DZ	$V_Z(I_{ZT}=5_{MA})=3.4...3.8B; Z_{ZT}(I_{ZT}=5_{MA})<95OM$	A	nc	K
KZG	BZX84C3V9	VISH	DZ	$V_Z(I_{ZT}=5_{MA})=3.7...4.1B; Z_{ZT}(I_{ZT}=5_{MA})<90OM$	A	nc	K
KZH	BZX84C4V3	VISH	DZ	$V_Z(I_{ZT}=5_{MA})=4.0...4.6B; Z_{ZT}(I_{ZT}=5_{MA})<90OM$	A	nc	K
LO	HSMP-3860	HP	PIN	$I_F<1A; V_{BR}>50B; R_S(TYP)=3.0OM; C_D(TYP)=0.20пФ;$	A	nc	K
L1	BSS65	ZETEX	PNP	$V_{CB0}=-12B; I_C=-100_{MA}; P_D=330мВт; h_{21}=40...150; f_T>400MГц$	B	E	C
L2	HSMP-3862	HP	2xPIN	$I_F<1A; V_{BR}>50B; R_S(TYP)=3.0OM; C_D(TYP)=0.20пФ;$	A1	K2	K1 A2
L2	BSS69	ZETEX	PNP	$V_{CB0}=-40B; I_C=-100_{MA}; P_D=330мВт; h_{21}=50...150; f_T>200MГц$	B	E	C
L20	CMPD1001	CENTS	DIH	$I_F<250_{MA}; V_R=50B; V_F(I_F=10_{MA})<0.75B; I_R<100_{HA}; t_{RR}<50нс; C_T<35пФ$	A	nc	K
L20	BAS29	PHIL	DI	$V_R<90B; I_F<250_{MA}; V_F(I_F=200_{MA})<1.0B; C_D<35пФ; t_{RR}<50$	A	nc	K
L21	CMPD1001S	CENTS	2x DIH	$I_F<250_{MA}; V_R=90B; V_F(I_F=10_{MA})<0.75B; I_R<100_{HA}; t_{RR}<50нс; C_T<35пФ$	A1	K1	K2 A1
L21	BAS31	PHIL	2xDI	$V_R<30B; I_F<200_{MA}; V_F(I_F=100_{MA})<1.0B; I_R<2.0мкА; C_D<10пФ; t_{RR}<5нс$	A1	K2	K1 A2
L22	CMPD1001A	CENTS	2x DIH	$I_F<250_{MA}; V_R=90B; V_F(I_F=10_{MA})<0.75B; I_R<100_{HA}; t_{RR}<50нс; C_T<35пФ$	K2	K1	A2 A1
L22	BAS35	PHIL	2xDI	$V_R<90B; I_F<250_{MA}; V_F(I_F=200_{MA})<1.0B; C_D<35пФ; t_{RR}<50нс$	K1	K2	A1 A2
L20	KSK211	SAMS	nFET	$V_{DS}=18B; P_D=200мВт; I_{DSS}>1_{MA}; g_f>9мСм;$	D	G	S
L3	HSMP-3863	HP	2xPIN	$I_F<1A; V_{BR}>50B; R_S(TYP)=3.0OM; C_D(TYP)=0.20пФ;$	K1	K2	A1 A2
L3	KST1623L3	SAMS	NPN	$V_{CB0}=50B; I_C=100_{MA}; P_D=350мВт; h_{21}=60...120; f_T>200MГц$	B	E	C
L3	BSS70	ZETEX	PNP	$V_{CB0}=-40B; I_C=-100_{MA}; P_D=330мВт; h_{21}=100...300; f_T>250MГц$	B	E	C
L31	BAV23S	PHIL	2xD	$V_R<200B; I_F<225_{MA}; V_F(I_F=100_{MA})<1.0B; C_D<5пФ; t_{RR}<50нс$	A1	K2	K1 A2
L4	HSMP-3864	HP	2xPIN	$I_F<1A; V_{BR}>50B; R_S(TYP)=3.0OM; C_T(TYP)=0.20пФ;$	A1	A2	K1 K2
L4	KST1623L4	SAMS	NPN	$V_{CB0}=50B; I_C=100_{MA}; P_D=350мВт; h_{21}=90...180; f_T>200MГц$	B	E	C
L4	BAT54	VISH	SHD	$V_R<30B; I_F<200_{MA}; V_F(I_F=100_{MA})<1.0B; I_R<2мкА; C_D<10пФ; t_{RR}<5нс$	A	nc	K
L4Z	BAT54	ZETEX	SHD	$V_R<30B; I_F<200_{MA}; V_F(I_F=100_{MA})<1.0B; I_R<4.0мкА; C_D<10пФ; t_{RR}<5нс$	A	nc	K
L42	BAT54A	PHIL	2xSHD	$V_R<30B; I_F<200_{MA}; V_F(I_F=1_{MA})<320_{MB}; C_D<10пФ; t_{RR}<5нс$	K1	K2	A1 A2
L42	BAT54A	VISH	SHD	$V_R<30B; I_F<200_{MA}; V_F(I_F=100_{MA})<1.0B; I_R<2.0мкА; C_D<10пФ; t_{RR}<5нс$	K1	K2	A1 A2
L42	BAT54A	ZETEX	SHD	$V_R<30B; I_F<200_{MA}; V_F(I_F=100_{MA})<1.0B; I_R<4.0мкА; C_D<10пФ; t_{RR}<5нс$	K1	K2	A1 A2
L43	BAT54C	PHIL	2xSHD	$V_R<30B; I_F<200_{MA}; V_F(I_F=1_{MA})<320_{MB}; C_D<10пФ; t_{RR}<5нс$	A1	A2	K1 K2
L43	BAT54B	VISH	2xSHD	$V_R<30B; I_F<200_{MA}; V_F(I_F=100_{MA})<1.0B; I_R<2.0мкА; C_D<10пФ; t_{RR}<5нс$	A1	A2	K1 K2
L43	BAT54C	VISH	2xSHD	$V_R=30B; I_F=200_{MA}; P_D=200мВт; t_{RR}<5нс$	A1	A2	K1 K2
L43	BAT54C	ZETEX	2xSHD	$V_R<30B; I_F<200_{MA}; V_F(I_F=100_{MA})<1.0B; I_R<4.0мкА; C_D<10пФ; t_{RR}<5нс$	A1	A2	K1 K2
L44	BAT54S	PHIL	2xSHD	$V_R<30B; I_F<200_{MA}; V_F(I_F=1_{MA})<320_{MB}; C_D<10пФ; t_{RR}<5нс$	A1	K2	K1 A2
L44	BAT54S	VISH	2xSHD	$V_R<30B; I_F<200_{MA}; V_F(I_F=100_{MA})<1.0B; I_R<2.0мкА; C_D<10пФ; t_{RR}<5нс$	A1	K2	K1 A2
L44	BAT54S	ZETEX	2xSHD	$V_R<30B; I_F<200_{MA}; V_F(I_F=100_{MA})<1.0B; I_R<4.0мкА; C_D<10пФ; t_{RR}<5нс$	A1	K2	K1 A2
L4p	BAT54	PHIL	SHD	$V_R<30B; I_F<200_{MA}; V_F(I_F=1_{MA})<320_{MB}; C_D<10пФ; t_{RR}<5нс$	A	nc	K
L5	KST1623L5	SAMS	NPN	$V_{CB0}=50B; I_C=100_{MA}; P_D=350мВт; h_{21}=135...270; f_T>200MГц$	B	E	C
L5	BSS65R	ZETEX	PNP	$V_{CB0}=-12B; I_C=-100_{MA}; P_D=330мВт; h_{21}=40...150; f_T>400MГц$	B	E	C
L52	BAS678	PHIL	FD	$V_R<80B; I_F<250_{MA}; V_F(I_F=200_{MA})<1.0B; C_D<2пФ; t_{RR}<6нс$	A	nc	K
L5p	BAS55	PHIL	FD	$V_R<60B; I_F<250_{MA}; V_F(I_F=200_{MA})<1.0B; C_D<2.5пФ; t_{RR}<6нс$	A	nc	K

SOT23, SOD23 (продолжение)

Код	Типономинал	Фирма	Функция	Особенности	Цоколевка		
					1	2	3
L6	KST1623L6	SAMS	NPN	$V_{CB0}=50B; I_C=100mA; P_D=350mBT; h_{21}=200...400; f_T>200MГц$	B	E	C
L6	BAR17	SIEM	PIN	$V_R<100B; I_F<140mA; V_F(I_F=100mA)<1.0B; I_R<0.05mA; C_D<0.37пФ$	A	nc	K
L6	BSS69R	ZETEX	PNP	$V_{CB0}=-40B; I_C=-100mA; P_D=330mBT; h_{21}=50...150; f_T>200MГц$	B	E	C
L7	KST1623L7	SAMS	NPN	$V_{CB0}=50B; I_C=100mA; P_D=350mBT; h_{21}=300...600; f_T>200MГц$	B	E	C
L7	BAR14-1	SIEM	2xPIN	$V_R<100B; I_F<140mA; V_F(I_F=100mA)<1.05B; I_R<0.1mA; C_D<0.2пФ$	A 1	K2	K1 A2
L7	BSS70R	ZETEX	PNP	$V_{CB0}=-40B; I_C=-100mA; P_D=330mBT; h_{21}=100...300; f_T>250MГц$	B	E	C
L8	BAR15-1	SIEM	2xPIN	$V_R<100B; I_F<140mA; V_F(I_F=100mA)<1.05B; I_R<0.1mA; C_D<0.2пФ$	A 1	A2	K1 K2
L9	BAR16-1	SIEM	2xPIN	$V_R<100B; I_F<140mA; V_F(I_F=100mA)<1.05B; I_R<0.1mA; C_D<0.2пФ$	K 1	K2	A1 A2
LA	BF550	SIEM	PNP	$V_{CB0}=-40B; I_C=-25mA; P_D=280mBT; h_{21}=50...250; f_T=350MГц$	B	E	C
LAp	BF550	PHIL	PNP	$V_{CB0}=-40B; I_C=-25mA; P_D=250mBT; h_{21}>50; f_T=325MГц$	B	E	C
LB	BF999	SIEM	nMOS	$V_{DS}=20B; I_D=30mA; P_D=200mBT; N_F=1.0дБ; I_{DSS}=5...18mA; g_f=18мСм$	G	D	S
LD	BF543	SIEM	nMOS	$V_{DS}=20B; I_D=30mA; P_D=200mBT; N_F=1.0дБ$	G	D	S
LD	BF543	TELEF	nMOS	$V_{DS}=20B; I_D=30mA; P_D=200mBT; g_f=70мС; R_{DS(ON)}=100M$	G	D	S
LE	BF660	SIEM	PNP	$V_{CB0}=-40B; I_C=-25mA; P_D=280mBT; h_{21}>30; f_T=700MГц$	B	E	C
LEp	BF660	PHIL	PNP	$V_{CB0}=-30B; I_C=-25mA; P_D=280mBT; h_{21}>30; f_T=650MГц$	B	E	C
LGs	BF775A	SIEM	NPN	$V_{CB0}=25B; I_C=30mA; P_D=280mBT; h_{21}=50...250; f_T=5800MГц$	B	E	C
LH	BF569	SIEM	PNP	$V_{CB0}=-40B; I_C=-30mA; P_D=280mBT; h_{21}>30; f_T>950MГц$	B	E	C
LHp	BF660	PHIL	NPN	$V_{CB0}=35B; I_C=30mA; P_D=280mBT; h_{21}=50; f_T=900MГц$	B	E	C
LK	BF799	SIEM	NPN	$V_{CB0}=30B; I_C=35mA; P_D=280mBT; h_{21}=40...250; f_T=1100MГц$	B	E	C
LOs	BF775	SIEM	NPN	$V_{CB0}=20B; I_C=30mA; P_D=280mBT; h_{21}=40...250; f_T=4500MГц$	B	E	C
LRs	BF517	SIEM	NPN	$V_{CB0}=20B; I_C=25mA; P_D=280mBT; h_{21}=25...250; f_T=2000MГц$	B	E	C
LSs	BF770A	SIEM	NPN	$V_{CB0}=15B; I_C=50mA; P_D=300mBT; h_{21}>40; f_T=5500MГц$	B	E	C
M1J	MMBT2369LT1	MOT	NPN	$V_{CB0}=40B; I_C=200mA; P_D=300mBT; h_{21}=40...120;$	B	E	C
M3	KDV173	KEC	2xPIN	$V_R=50B; I_R=0.1mA; C_1=0.25пФ; R_S<7.0M$	A 1	K2	K1 A2
M3	KST812M3	SAMS	PNP	$V_{CB0}=-50B; I_C=-100mA; P_D=350mBT; h_{21}=60...120;$	B	E	C
M3A	MMBT24LT1	MOT	NPN	$V_{CB0}=40B; I_C=50mA; P_D=300mBT; h_{21}>30; f_T>400MГц$	B	E	C
M3B	MMBT918LT1	MOT	NPN	$V_{CB0}=30B; I_C=50mA; P_D=300mBT; h_{21}>20; f_T>600MГц$	B	E	C
M3J	MMBT69LT1	MOT	PNP	$V_{CB0}=-15B; P_D=300mBT; h_{21}>30...300; f_T>2000MГц$	B	E	C
M4	KST812M4	SAMS	PNP	$V_{CB0}=-50B; I_C=-100mA; P_D=350mBT; h_{21}=90...180;$	B	E	C
M5	KST812M5	SAMS	PNP	$V_{CB0}=-50B; I_C=-100mA; P_D=350mBT; h_{21}=135...270;$	B	E	C
M6	KST812M6	SAMS	PNP	$V_{CB0}=-50B; I_C=-100mA; P_D=350mBT; h_{21}=200...400;$	B	E	C
M6	BSS66	ZETEX	NPN	$V_{CB0}=60B; I_C=-100mA; P_D=330mBT; h_{21}=50...150; f_T>250MГц$	B	E	C
M7	KST812M7	SAMS	PNP	$V_{CB0}=-50B; I_C=-100mA; P_D=350mBT; h_{21}=300...600;$	B	E	C
M7	BSS67	ZETEX	NPN	$V_{CB0}=60B; I_C=-100mA; P_D=330mBT; h_{21}=100...300; f_T>300MГц$	B	E	C
M8	BSS66R	ZETEX	NPN	$V_{CB0}=60B; I_C=-100mA; P_D=330mBT; h_{21}=50...150; f_T>250MГц$	B	E	C
M9	BSS67R	ZETEX	NPN	$V_{CB0}=60B; I_C=-100mA; P_D=330mBT; h_{21}=100...300; f_T>300MГц$	B	E	C
MA	FMMTA06R	ZETEX	NPN	$V_{CB0}=80B; I_C=500mA; P_D=330mBT; h_{21}>50; f_T>100MГц$	B	E	C
MB	FMMTA56R	ZETEX	PNP	$V_{CB0}=-80B; I_C=-500mA; P_D=330mBT; h_{21}>50; f_T>100MГц$	B	E	C
MC	ZVN3306F	ZETEX	nMOS	$V_{DS}=60B; I_D=150mA; P_D=330mBT; g_f=100MOM; R_{DS(ON)}=50M$	G	S	D
MCs	BFS17P	SIEM	NPN	$V_{CB0}=25B; I_C=25mA; P_D=280mBT; h_{21}=20...150; f_T=2500MГц$	B	E	C
MF	ZVN3310F	ZETEX	nMOS	$V_{DS}=100B; I_D=100mA; P_D=330mBT; g_f=150MOM; R_{DS(ON)}=50M$	G	S	D
ML	ZVP3306F	ZETEX	pMOS	$V_{DS}=-60B; I_D=90mA; P_D=330mBT; g_f=25MOM; R_{DS(ON)}=800M$	G	S	D
MR	ZVP3310F	ZETEX	pMOS	$V_{DS}=-100B; I_D=45mA; P_D=330mBT; g_f=60MOM; R_{DS(ON)}=140M$	G	S	D
MT	ZVP1320F	ZETEX	pMOS	$V_{DS}=-200B; I_D=35mA; P_D=330mBT; g_f=150MOM; R_{DS(ON)}=2.50M$	G	S	D
MU	ZVN3320F	ZETEX	nMOS	$V_{DS}=200B; I_D=60mA; P_D=330mBT; g_f=100MOM; R_{DS(ON)}=10M$	G	S	D
MV	BS170F	ZETEX	nMOS	$V_{DS}=60B; I_D=150mA; P_D=330mBT;$	G	S	D
MX	BS250F	ZETEX	pMOS	$V_{DS}=-45B; I_D=90mA; P_D=330mBT; g_f=200MOM; R_{DS(ON)}=50M$	G	S	D
MY	VN10LF	ZETEX	nMOS	$V_{DS}=60B; I_D=150mA; P_D=330mBT;$	G	S	D
MZ	ZVN4106F	ZETEX	nMOS	$V_{DS}=60B; I_D=200mA; P_D=330mBT; g_f=75MOM; R_{DS(ON)}=250M$	G	S	D

SOT23, SOD23 (продолжение)

Код	Типономинал	Фирма	Функция	Особенности	Цоколевка		
					1	2	3
N	BAV70	VISH	2xDI	$V_R < 70B; I_F < 300_{MA}; V_F(I_F = 150_{MA}) < 1.25B; I_R < 5.0_{mKA}; C_D < 4.0_{пФ}; t_{RR} < 6_{нс}$	A1	A 2	K1 K2
NO	TN0200T	SIL	nMOS	$V_{DS} = 20B; I_D = 730_{MA}; P_D = 350_{мВт}; I_{DSS} = 8...20_{MA}; g_f = 4_{мСм};$	G	S	D
N1	TN0201T	SIL	nMOS	$V_{DS} = 20B; I_D = 390_{MA}; P_D = 350_{мВт}; g_f = 45_{мОм}; R_{DS(ON)} = 0.75_{Ом}$	G	S	D
N12	TMPT2221	ALLEG	NPN	$V_{CB0} = 60B; I_{CB0} < 10_{HA}; h_{21} = 40...120; V_{CE(sat)} < 0.4B$ $f_T > 250_{МГц}$	B	E	C
N3	KDV152S	KEC	BD	$V_R = 15B; I_R = 50_{HA}; C_{2V} = 0.25_{пФ}; C_{8V} = 26_{пФ}; I_S < 0.30_{MA}$	A	n c	K
N54	TMPT2221A	ALLEG	NPN	$V_{CB0} = 75B; I_{CB0} < 10_{HA}; h_{21} = 40...120; V_{CE(sat)} < 0.3B$ $f_T > 250_{МГц}$	B	E	C
NA	FMMTA05R	ZETEX	NPN	$V_{CB0} = 60B; I_C = 500_{MA}; P_D = 330_{мВт}; h_{21} > 50; f_T > 100_{МГц}$	B	E	C
NB	BF599	SIEM	NPN	$V_{CB0} = 40B; I_C = 25_{MA}; P_D = 280_{мВт}; h_{21} > 38; f_T = 550_{МГц}$	B	E	C
NB	FMMTA55R	ZETEX	PNP	$V_{CB0} = -60B; I_C = -500_{MA}; P_D = 330_{мВт}; h_{21} > 50; f_T > 100_{МГц}$	B	E	C
NC	BF840	CDIL	NPN	$V_{CB0} = 40B; I_C = 25_{MA}; P_D = 280_{мВт}; h_{21} = 65...220;$ $f_T > 380_{МГц}$	B	E	C
NC	BF840	SIEM	NPN	$V_{CB0} = 40B; I_C = 25_{MA}; P_D = 280_{мВт}; h_{21} = 65...220;$ $f_T = 380_{МГц}$	B	E	C
NCp	BF840	PHIL	NPN	$V_{CB0} = 40B; I_C = 25_{MA}; P_D = 250_{мВт}; I_b = 4.5...15_{мКА};$ $f_T = 380_{МГц}$	B	E	C
ND	BF841	CDIL	NPN	$V_{CB0} = 40B; I_C = 25_{MA}; P_D = 280_{мВт}; h_{21} = 35...125;$ $f_T > 380_{МГц}$	B	E	C
ND	BF841	SIEM	NPN	$V_{CB0} = 40B; I_C = 25_{MA}; P_D = 280_{мВт}; h_{21} = 35...125;$ $f_T = 380_{МГц}$	B	E	C
NDp	BF841	PHIL	NPN	$V_{CB0} = 40B; I_C = 25_{MA}; P_D = 250_{мВт}; I_b = 8...28_{мКА};$ $f_T = 380_{МГц}$	B	E	C
NS	TN0200TS	SIL	nMOS	$V_{DS} = 20B; I_D = 1200_{MA}; P_D = 1000_{мВт}; g_f = 2200_{мОм}; R_{DS(ON)} = 0.40_{Ом}$	G	S	D
P	BAW56	VISH	2xDI	$V_R < 70B; I_F < 300_{MA}; V_F(I_F = 150_{MA}) < 1.25B; I_R < 5.0_{mKA};$ $C_D < 5.0_{пФ}; t_{RR} < 6_{нс}$	K1	K 2	A1 A2
P0	TP0101T	SIL	nMOS	$V_{DS} = -20B; I_D = 600_{MA}; P_D = 350_{мВт}; g_f = 1300_{мОм}; R_{DS(ON)} = 0.65_{Ом}$	G	S	D
p01	PDTA143ET	PHIL	D-PNP	$V_{CB0} = -50B; I_C = -100_{MA}; P_D = 250_{мВт}; h_{21} > 20;$	B	E	C
p02	PDTC143ET	PHIL	D-NPN	$V_{CB0} = 50B; I_C = 100_{MA}; P_D = 250_{мВт}; h_{21} > 20;$	B	E	C
p03	PDTA114ET	PHIL	D-PNP	$V_{CB0} = -50B; I_C = -50_{MA}; P_D = 250_{мВт}; h_{21} > 30;$	B	E	C
p04	PDTA143ET	PHIL	D-NPN	$V_{CB0} = 50B; I_C = 50_{MA}; P_D = 250_{мВт}; h_{21} > 30;$	B	E	C
p05	PDTA124ET	PHIL	D-PNP	$V_{CB0} = -50B; I_C = -30_{MA}; P_D = 250_{мВт}; h_{21} > 56;$	B	E	C
p06	PDTC124ET	PHIL	D-NPN	$V_{CB0} = 50B; I_C = 30_{MA}; P_D = 250_{мВт}; h_{21} > 56;$	B	E	C
p07	PDTA144ET	PHIL	D-PNP	$V_{CB0} = -50B; I_C = -100_{MA}; P_D = 250_{мВт}; h_{21} > 68;$	B	E	C
p08	PDTC144ET	PHIL	D-NPN	$V_{CB0} = 50B; I_C = 30_{MA}; P_D = 250_{мВт}; h_{21} > 68;$	B	E	C
p09	PDTB144ET	PHIL	PNP	$V_{CB0} = 50B; I_C = 30_{MA}; P_D = 250_{мВт}; h_{21} > 68;$	D	S	G
P1	SST201	SIL	nFET	$V_{DS} = 40B; P_D = 350_{мВт}; I_{DSS} = 0.2...1_{MA}; g_f = 0.5_{мСм}$	B	E	C
p10	PDTD114ET	PHIL	D-NPN	$V_{CB0} = 50B; I_C = 500_{MA}; P_D = 250_{мВт}; h_{21} > 56;$	B	E	C
p1A	PMBT3904	PHIL	NPN	$V_{CB0} = 60B; I_C = 200_{MA}; P_D = 250_{мВт}; h_{21} = 100...300;$ $f_T > 300_{МГц}$	B	E	C
p1B	PMBT2222	PHIL	NPN	$V_{CB0} = 60B; I_C = 600_{MA}; P_D = 250_{мВт}; h_{21} = 100...300;$ $f_T > 250_{МГц}$	B	E	C
p1D	PMBTA42	PHIL	NPN	$V_{CB0} = 300B; I_C = 500_{MA}; P_D = 250_{мВт}; h_{21} > 40; f_T > 50_{МГц}$	B	E	C
p1E	PMBTA43	PHIL	NPN	$V_{CB0} = 200B; I_C = 500_{MA}; P_D = 250_{мВт}; h_{21} > 40; f_T > 50_{МГц}$	B	E	C
p1F	PMBT5550	PHIL	NPN	$V_{CB0} = 160B; I_C = 600_{MA}; P_D = 250_{мВт}; h_{21} = 60...250;$ $f_T = 100...300$	B	E	C
p1G	PMBTA06	PHIL	NPN	$V_{CB0} = 80B; I_C = 500_{MA}; P_D = 250_{мВт}; h_{21} > 50; f_T > 100_{МГц}$	B	E	C
p1H	PMBTA05	PHIL	NPN	$V_{CB0} = 60B; I_C = 500_{MA}; P_D = 250_{мВт}; h_{21} > 50; f_T > 100_{МГц}$	B	E	C
p1J	PMBT2369	PHIL	NPN	$V_{CB0} = 40B; I_C = 500_{MA}; P_D = 250_{мВт}; h_{21} = 40...120$	B	E	C
p1K	PMBT6428	PHIL	NPN	$V_{CB0} = 60B; I_C = 200_{MA}; P_D = 250_{мВт}; h_{21} = 250...650;$ $f_T = 100...700_{МГц}$	B	E	C
p1L	PMBT6429	PHIL	NPN	$V_{CB0} = 55B; I_C = 200_{MA}; P_D = 250_{мВт}; h_{21} = 500...1250;$ $f_T = 100...700_{МГц}$	B	E	C
p1M	PMBTA13	PHIL	NPN	$V_{CB0} = 30B; I_C = 300_{MA}; P_D = 250_{мВт}; h_{21} > 5000; f_T > 125_{МГц}$	B	E	C
p1N	PMBTA12	PHIL	NPN	$V_{CB0} = 30B; I_C = 300_{MA}; P_D = 250_{мВт}; h_{21} > 10000; f_T > 125_{МГц}$	B	E	C
p1P	PMBT2222A	PHIL	NPN	$V_{CB0} = 75B; I_C = 600_{MA}; P_D = 250_{мВт}; h_{21} = 100...300;$ $f_T > 300_{МГц}$	B	E	C
p1Q	PMBT5088	PHIL	NPN	$V_{CB0} = 30B; I_C = 50_{MA}; P_D = 250_{мВт}; h_{21} = 350...1400$	B	E	C
P2	BFR92ALT1	MOT	NPN	$V_{CB0} = 20B; I_C = 25_{MA}; P_D = 273_{мВт}; h_{21} > 40; f_T = 4500_{МГц}$	B	E	C
P2	SST202	SIL	nFET	$V_{DS} = 40B; P_D = 350_{мВт}; I_{DSS} = 0.9...4.5_{MA}; g_f = 1_{мСм}$	D	S	G
p2A	PMBT3906	PHIL	PNP	$V_{CB0} = -40B; I_C = -200_{MA}; P_D = 250_{мВт}; h_{21} = 100...300;$ $f_T > 250_{МГц}$	B	E	C
p2B	PMBT2907	PHIL	PNP	$V_{CB0} = -60B; I_C = -600_{MA}; P_D = 250_{мВт}; h_{21} > 30; f_T > 200_{МГц}$	B	E	C
p2D	PMBT92	PHIL	PNP	$V_{CB0} = -300B; I_C = -500_{MA}; P_D = 250_{мВт}; h_{21} > 40; f_T > 50_{МГц}$	B	E	C
p2E	PMBT93	PHIL	PNP	$V_{CB0} = -200B; I_C = -500_{MA}; P_D = 250_{мВт}; h_{21} > 40; f_T > 50_{МГц}$	B	E	C
p2F	PMBT2907A	PHIL	PNP	$V_{CB0} = -60B; I_C = -600_{MA}; P_D = 250_{мВт}; h_{21} > 50; f_T > 200_{МГц}$	B	E	C

SOT23, SOD23 (продолжение)

Код	Типономинал	Фирма	Функция	Особенности	Цоколевка		
					1	2	3
p2G	PMBTA56	PHIL	PNP	$V_{CB0}=-80B; I_C=-500mA; P_D=250mBT; h_{21}>50; f_T>50MГц$	B	E	C
p2H	PMBTA55	PHIL	PNP	$V_{CB0}=-60B; I_C=-500mA; P_D=250mBT; h_{21}>50; f_T>50MГц$	B	E	C
p2L	PMBT5401	PHIL	PNP	$V_{CB0}=-160B; I_C=-500mA; P_D=250mBT; h_{21}=60...240; f_T=100...300 MГц$	B	E	C
p2T	PMBT4403	PHIL	PNP	$V_{CB0}=-40B; I_C=-600mA; P_D=250mBT; h_{21}=100...300; f_T>200MГц$	B	E	C
p2U	PMBTA63	PHIL	PNP	$V_{CB0}=-30B; I_C=-500mA; P_D=250mBT; h_{21}>5000; f_T>125MГц$	B	E	C
p2V	PMBTA64	PHIL	PNP	$V_{CB0}=-30B; I_C=-500mA; P_D=250mBT; h_{21}>10000; f_T>125MГц$	B	E	C
p2X	PMBT4401	PHIL	PNP	$V_{CB0}=40B; I_C=600mA; P_D=250mBT; h_{21}=100...300; f_T>250MГц$	B	E	C
P3	TPO202T	SIL	pMOS	$V_{DS}=20B; I_D=410mA; P_D=350mBT; g_F=600MOм; R_{DS(ON)}=0.9OM$	G	S	D
P4	SST204	SIL	nFET	$V_{DS}=25B; P_D=350mBT; I_{DSS}=0.2...3mA; g_F=0.5MCм$	D	S	G
p4F	PMBD353	PHIL	2xSHD	$V_R<4B; I_F<30mA; V_F(I_F=10mA)<600mB; C_D<1пФ$	K1	A2	A1 K2
P5	FMMT2369A	ZETEX	NPN	$V_{CB0}=40B; I_C=200mA; P_D=330mBT; h_{21}=40...120$	B	E	C
p5A	PMBD6050	PHIL	FD	$V_R<70B; I_F<215mA; V_F(I_F=150mA)<1.25B; I_R<100HA; C_D<1.5пФ; t_{RR}<4нс$	A	nc	K
p5B	PMBD6100	PHIL	2xFD	$V_R<70B; I_F<215mA; V_F(I_F=100mA)=0.85...1.1B; I_R<100HA; C_D<1.5пФ; t_{RR}<4нс$	A1	A2	K1 K2
p5C	PMBD7000	PHIL	2xFD	$V_R<100B; I_F<215mA; V_F(I_F=100mA)=0.75...1.25B; I_R<500HA; C_D<1.5пФ; t_{RR}<4нс$	A1	K2	K1 A2
p5D	PMBD914	PHIL	FD	$V_R<70B; I_F<215mA; V_F(I_F=150mA)<1.25B; I_{opp}<1мкA; C_D<1.5пФ; t_{RR}<4нс$	A	nc	K
p5G	PMBD352	PHIL	2xSHD	$V_R<4B; I_F<30mA; V_F(I_F=10mA)<600B; C_D<1пФ$	A1	K2	K1 A2
p8A	PMBZ5226B	PHIL	DZ	$V_Z(I_{ZT}=20mA)=3.3B; I_L(V_R=1.0B)<25мкA; Z_{ZT}(I_{ZT}=20mA)<1600OM; I_{ZM}=200mA$	A	nc	K
p8B	PMBZ5227B	PHIL	DZ	$V_Z(I_{ZT}=20mA)=3.6B; I_L(V_R=1.0B)<15мкA; Z_{ZT}(I_{ZT}=20mA)<1700OM; I_{ZM}=200mA$	A	nc	K
p8C	PMBZ5228B	PHIL	DZ	$V_Z(I_{ZT}=20mA)=3.9B; I_L(V_R=1.0B)<10мкA; Z_{ZT}(I_{ZT}=20mA)<1900OM; I_{ZM}=200mA$	A	nc	K
p8D	PMBZ5229B	PHIL	DZ	$V_Z(I_{ZT}=20mA)=4.3B; I_L(V_R=1.0B)<5мкA; Z_{ZT}(I_{ZT}=20mA)<2000OM; I_{ZM}=200mA$	A	nc	K
p8E	PMBZ5230B	PHIL	DZ	$V_Z(I_{ZT}=20mA)=4.7B; I_L(V_R=1.0B)<5мкA; Z_{ZT}(I_{ZT}=20mA)<2000OM; I_{ZM}=200mA$	A	nc	K
p8F	PMBZ5231B	PHIL	DZ	$V_Z(I_{ZT}=20mA)=5.1B; I_L(V_R=2.0B)<5мкA; Z_{ZT}(I_{ZT}=20mA)<2000OM; I_{ZM}=200mA$	A	nc	K
p8G	PMBZ5232B	PHIL	DZ	$V_Z(I_{ZT}=20mA)=5.6B; I_L(V_R=3.0B)<5мкA; Z_{ZT}(I_{ZT}=20mA)<1600OM; I_{ZM}=200mA$	A	nc	K
p8H	PMBZ5233B	PHIL	DZ	$V_Z(I_{ZT}=20mA)=6.0B; I_L(V_R=3.5B)<5мкA; Z_{ZT}(I_{ZT}=20mA)<1600OM; I_{ZM}=200mA$	A	nc	K
p8J	PMBZ5234B	PHIL	DZ	$V_Z(I_{ZT}=20mA)=6.2B; I_L(V_R=4.0B)<5мкA; Z_{ZT}(I_{ZT}=20mA)<1000OM; I_{ZM}=200mA$	A	nc	K
p8K	PMBZ5235B	PHIL	DZ	$V_Z(I_{ZT}=20mA)=6.8B; I_L(V_R=5.0B)<3мкA; Z_{ZT}(I_{ZT}=20mA)<750OM; I_{ZM}=200mA$	A	nc	K
p8L	PMBZ5236B	PHIL	DZ	$V_Z(I_{ZT}=20mA)=7.5B; I_L(V_R=6.0B)<3мкA; Z_{ZT}(I_{ZT}=20mA)<500OM; I_{ZM}=200mA$	A	nc	K
p8M	PMBZ5237B	PHIL	DZ	$V_Z(I_{ZT}=20mA)=8.2B; I_L(V_R=6.5B)<3мкA; Z_{ZT}(I_{ZT}=20mA)<500OM; I_{ZM}=200mA$	A	nc	K
p8N	PMBZ5238B	PHIL	DZ	$V_Z(I_{ZT}=20mA)=8.7B; I_L(V_R=6.5B)<3мкA; Z_{ZT}(I_{ZT}=20mA)<600OM; I_{ZM}=200mA$	A	nc	K
p8P	PMBZ5239B	PHIL	DZ	$V_Z(I_{ZT}=20mA)=9.1B; I_L(V_R=7.0B)<3мкA; Z_{ZT}(I_{ZT}=20mA)<600OM; I_{ZM}=200mA$	A	nc	K
p8Q	PMBZ5240B	PHIL	DZ	$V_Z(I_{ZT}=20mA)=10B; I_L(V_R=8.0B)<3мкA; Z_{ZT}(I_{ZT}=20mA)<600OM; I_{ZM}=200mA$	A	nc	K
p8R	PMBZ5241B	PHIL	DZ	$V_Z(I_{ZT}=20mA)=11B; I_L(V_R=8.4B)<3мкA; Z_{ZT}(I_{ZT}=20mA)<600OM; I_{ZM}=200mA$	A	nc	K
p8S	PMBZ5242B	PHIL	DZ	$V_Z(I_{ZT}=20mA)=12B; I_L(V_R=9.1B)<3мкA; Z_{ZT}(I_{ZT}=20mA)<600OM; I_{ZM}=200mA$	A	nc	K
p8T	PMBZ5243B	PHIL	DZ	$V_Z(I_{ZT}=9.5mA)=13B; I_L(V_R=9.9B)<0.5мкA; Z_{ZT}(I_{ZT}=9.5mA)<600OM; I_{ZM}=200mA$	A	nc	K
p8U	PMBZ5244B	PHIL	DZ	$V_Z(I_{ZT}=9.0mA)=14B; I_L(V_R=10B)<0.1мкA; Z_{ZT}(I_{ZT}=9.0mA)<600OM; I_{ZM}=200mA$	A	nc	K
p8V	PMBZ5245B	PHIL	DZ	$V_Z(I_{ZT}=8.5mA)=15B; I_L(V_R=11B)<0.1мкA; Z_{ZT}(I_{ZT}=8.5mA)<600OM; I_{ZM}=200mA$	A	nc	K

SOT23, SOD23 (продолжение)

Код	Типономинал	Фирма	Функция	Особенности	Цоколевка		
					1	2	3
p8W	PMBZ5246B	PHIL	DZ	$V_Z(I_{ZT}=7.8\text{mA})=16\text{B}$; $I_L(V_R=12\text{B})<0.1\text{мкА}$; $Z_{ZT}(I_{ZT}=7.8\text{mA})<600\text{ОМ}$; $I_{ZM}=200\text{mA}$	A	nc	K
p8X	PMBZ5247B	PHIL	DZ	$V_Z(I_{ZT}=7.4\text{mA})=17\text{B}$; $I_L(V_R=13\text{B})<0.1\text{мкА}$; $Z_{ZT}(I_{ZT}=7.4\text{mA})<600\text{ОМ}$; $I_{ZM}=200\text{mA}$	A	nc	K
p8Y	PMBZ5248B	PHIL	DZ	$V_Z(I_{ZT}=7.0\text{mA})=18\text{B}$; $I_L(V_R=14\text{B})<0.1\text{мкА}$; $Z_{ZT}(I_{ZT}=7.0\text{mA})<600\text{ОМ}$; $I_{ZM}=200\text{mA}$	A	nc	K
p8Z	PMBZ5249B	PHIL	DZ	$V_Z(I_{ZT}=6.6\text{mA})=19\text{B}$; $I_L(V_R=14\text{B})<0.1\text{мкА}$; $Z_{ZT}(I_{ZT}=6.6\text{mA})<600\text{ОМ}$; $I_{ZM}=200\text{mA}$	A	nc	K
P9	BCX70KR	ZETEX	NPN	$V_{CB0}=45\text{B}$; $I_C=200\text{mA}$; $P_D=330\text{мВт}$; $h_{21}=380\dots630$; $f_T>250\text{МГц}$	B	E	C
p9A	PLVA650A	PHIL	DZ	$V_Z(I_{ZT}=250\text{mA})=4.8\dots5.2\text{B}$; $I_L(V_R=0.8*V_Z)<20\text{мкА}$; $Z_{ZT}(I_{ZT}=250\text{mA})<700\text{ОМ}$; $I_{ZM}=250\text{mA}$	A	nc	K
p9B	PLVA653A	PHIL	DZ	$V_Z(I_{ZT}=250\text{mA})=5.1\dots5.5\text{B}$; $I_L(V_R=0.8*V_Z)<5\text{мкА}$; $Z_{ZT}(I_{ZT}=250\text{mA})<250\text{ОМ}$; $I_{ZM}=250\text{mA}$	A	nc	K
p9C	PLVA656A	PHIL	DZ	$V_Z(I_{ZT}=250\text{mA})=5.4\dots5.8\text{B}$; $I_L(V_R=0.8*V_Z)<1\text{мкА}$; $Z_{ZT}(I_{ZT}=250\text{mA})<100\text{ОМ}$; $I_{ZM}=250\text{mA}$	A	nc	K
p9D	PLVA659A	PHIL	DZ	$V_Z(I_{ZT}=250\text{mA})=5.7\dots6.1\text{B}$; $I_L(V_R=0.8*V_Z)<500\text{нА}$; $Z_{ZT}(I_{ZT}=250\text{mA})<100\text{ОМ}$; $I_{ZM}=250\text{mA}$	A	nc	K
p9E	PLVA662A	PHIL	DZ	$V_Z(I_{ZT}=250\text{mA})=6.0\dots6.4\text{B}$; $I_L(V_R=0.8*V_Z)<100\text{нА}$; $Z_{ZT}(I_{ZT}=250\text{mA})<100\text{ОМ}$; $I_{ZM}=250\text{mA}$	A	nc	K
p9F	PLVA665A	PHIL	DZ	$V_Z(I_{ZT}=250\text{mA})=6.3\dots6.7\text{B}$; $I_L(V_R=0.8*V_Z)<50\text{нА}$; $Z_{ZT}(I_{ZT}=250\text{mA})<100\text{ОМ}$; $I_{ZM}=250\text{mA}$	A	nc	K
p9G	PLVA668A	PHIL	DZ	$V_Z(I_{ZT}=250\text{mA})=6.6\dots7.0\text{B}$; $I_L(V_R=0.8*V_Z)<10\text{нА}$; $Z_{ZT}(I_{ZT}=250\text{mA})<100\text{ОМ}$; $I_{ZM}=250\text{mA}$	A	nc	K
p9J	PLVA2650A	PHIL	2xDZ	$V_Z(I_{ZT}=250\text{mA})=4.8\dots5.2\text{B}$; $I_L(V_R=0.8*V_Z)<20\text{мкА}$; $Z_{ZT}(I_{ZT}=250\text{mA})<700\text{ОМ}$; $I_{ZM}=250\text{mA}$	K1	K2	A1 A2
p9K	PLVA2653A	PHIL	2x DZ	$V_Z(I_{ZT}=250\text{mA})=5.1\dots5.8\text{B}$; $I_L(V_R=0.8*V_Z)<5\text{мкА}$; $Z_{ZT}(I_{ZT}=250\text{mA})<250\text{ОМ}$; $I_{ZM}=250\text{mA}$	K1	K2	A1 A2
p9L	PLVA2656A	PHIL	2x DZ	$V_Z(I_{ZT}=250\text{mA})=5.4\dots5.8\text{B}$; $I_L(V_R=0.8*V_Z)<1\text{мкА}$; $Z_{ZT}(I_{ZT}=250\text{mA})<100\text{ОМ}$; $I_{ZM}=250\text{mA}$	K1	K2	A1 A2
p9M	PLVA2659A	PHIL	2x DZ	$V_Z(I_{ZT}=250\text{mA})=5.7\dots6.1\text{B}$; $I_L(V_R=0.8*V_Z)<500\text{нА}$; $Z_{ZT}(I_{ZT}=250\text{mA})<100\text{ОМ}$; $I_{ZM}=250\text{mA}$	K1	K2	A1 A2
p9N	PLVA2662A	PHIL	2x DZ	$V_Z(I_{ZT}=250\text{mA})=6.0\dots6.4\text{B}$; $I_L(V_R=0.8*V_Z)<100\text{нА}$; $Z_{ZT}(I_{ZT}=250\text{mA})<100\text{ОМ}$; $I_{ZM}=250\text{mA}$	K1	K2	A1 A2
p9O	PLVA2665A	PHIL	2x DZ	$V_Z(I_{ZT}=250\text{mA})=6.3\dots6.7\text{B}$; $I_L(V_R=0.8*V_Z)<50\text{нА}$; $Z_{ZT}(I_{ZT}=250\text{mA})<100\text{ОМ}$; $I_{ZM}=250\text{mA}$	K1	K2	A1 A2
p9P	PLVA2668A	PHIL	2x DZ	$V_Z(I_{ZT}=250\text{mA})=6.6\dots7.0\text{B}$; $I_L(V_R=0.8*V_Z)<10\text{нА}$; $Z_{ZT}(I_{ZT}=250\text{mA})<100\text{ОМ}$; $I_{ZM}=250\text{mA}$	K1	K2	A1 A2
PA	BA885	SIEM	PIN	$V_R<50\text{B}$; $I_F<50\text{mA}$; $V_F(I_F=10\text{mA})<1.1\text{B}$; $I_R<0.05\text{мкА}$; $C_D<0.4\text{пФ}$	A	nc	K
pA2	PMBD2836	PHIL	2xFD	$V_R<75\text{B}$; $I_F<215\text{mA}$; $V_F(I_F=100\text{mA})=1.25$; $I_R<100\text{нА}$; $C_D<2.5\text{пФ}$; $t_{RR}<4\text{нс}$	K1	K2	A1 A2
pA3	PMBD2835	PHIL	2xFD	$V_R<35\text{B}$; $I_F<215\text{mA}$; $V_F(I_F=100\text{mA})=1.25$; $I_R<100\text{нА}$; $C_D<2.5\text{пФ}$; $t_{RR}<4\text{нс}$	K1	K2	A1 A2
pA5	PMBD2837	PHIL	2xFD	$V_R<30\text{B}$; $I_F<215\text{mA}$; $V_F(I_F=100\text{mA})=1.25$; $I_R<100\text{нА}$; $C_D<2.5\text{пФ}$; $t_{RR}<4\text{нс}$	A1	A2	K1 K2
pA6	PMBD2838	PHIL	2xFD	$V_R<50\text{B}$; $I_F<215\text{mA}$; $V_F(I_F=100\text{mA})=1.25$; $I_R<100\text{нА}$; $C_D<2.5\text{пФ}$; $t_{RR}<4\text{нс}$	A1	A2	K1 K2
PC	BA886	SIEM	PIN	$V_R<50\text{B}$; $I_F<50\text{mA}$; $V_F(I_F=10\text{mA})<1.15\text{B}$; $I_R<0.05\text{мкА}$; $C_D<0.2\text{пФ}$	A	nc	K
PDs	BA887	SIEM	PIN	$V_R<50\text{B}$; $I_F<100\text{mA}$; $I_R<0.02\text{мкА}$; $C_D<0.27\text{пФ}$	A	nc	K
pGI	PMBT5551	PHIL	NPN	$V_{CB0}=180\text{B}$; $I_C=600\text{mA}$; $P_D=250\text{мВт}$; $h_{21}=80\dots250$; $f_T=100\dots300$	B	E	C
PMs	BAR66	SIEM	2xPIN	$V_R<150\text{B}$; $I_F<200\text{mA}$; $V_F(I_F=50\text{mA})<1.2\text{B}$; $C_D<0.35\text{пФ}$	A1	K2	K1 A2
pO4	PMSS3904	PHIL	NPN	$V_{CB0}=60\text{B}$; $I_C=200\text{mA}$; $P_D=300\text{мВт}$; $h_{21}=100\dots300$; $f_T>180\text{МГц}$	B	E	K
PO6	PMSS3906	PHIL	PNP	$V_{CB0}=-40\text{B}$; $I_C=-200\text{mA}$; $P_D=200\text{мВт}$; $h_{21}=100\dots300$; $f_T>150\text{МГц}$	B	E	C
POs	BAR64	SIEM	PIN	$V_R<200\text{B}$; $I_F<100\text{mA}$; $V_F(I_F=50\text{mA})<1.1\text{B}$; $C_D<0.35\text{пФ}$	A	nc	K
PPs	BAR64-04	SIEM	2xPIN	$V_R<200\text{B}$; $I_F<100\text{mA}$; $V_F(I_F=50\text{mA})<1.1\text{B}$; $C_D<0.35\text{пФ}$	A1	K2	K1 A2
PRs	BAR64-05	SIEM	2xPIN	$V_R<200\text{B}$; $I_F<100\text{mA}$; $V_F(I_F=50\text{mA})<1.1\text{B}$; $C_D<0.35\text{пФ}$	A1	A2	K1 A2

SOT23, SOD23 (продолжение)

Код	Типономинал	Фирма	Функция	Особенности	Цоколевка		
					1	2	3
PS	TP0101TS	SIL	pMOS	$V_{DS}=-20B; I_D=1000mA; P_D=1000mBT; g_f=1300C_{M}; R_{DS(ON)}=0.65O_M$	G	S	D
PSs	BAR64-06	SIEM	2xPIN	$V_R<200B; I_F<100mA; V_{F(I_F=50mA)}<1.1B; C_D<0.35пФ$	K1	K2	A1 A2
R01	KSR1101	SAMS	D-NPN	$V_{CB0}=50B; I_C=100mA; P_D=200mBT; h_{21}>20; f_T>250MГц$	B	E	C
R02	KSR1102	SAMS	D-NPN	$V_{CB0}=50B; I_C=100mA; P_D=200mBT; h_{21}>30; f_T>250MГц$	B	E	C
R03	KSR1103	SAMS	D-NPN	$V_{CB0}=50B; I_C=100mA; P_D=200mBT; h_{21}>56; f_T>250MГц$	B	E	C
R04	KSR1104	SAMS	D-NPN	$V_{CB0}=50B; I_C=100mA; P_D=200mBT; h_{21}>68; f_T>250MГц$	B	E	C
R05	KSR1105	SAMS	D-NPN	$V_{CB0}=50B; I_C=100mA; P_D=200mBT; h_{21}>30; f_T>250MГц$	B	E	C
R06	KSR1106	SAMS	D-NPN	$V_{CB0}=50B; I_C=100mA; P_D=200mBT; h_{21}>68; f_T>250MГц$	B	E	C
R07	KSR1107	SAMS	D-NPN	$V_{CB0}=50B; I_C=100mA; P_D=200mBT; h_{21}>68; f_T>250MГц$	B	E	C
R08	KSR1108	SAMS	D-NPN	$V_{CB0}=50B; I_C=100mA; P_D=200mBT; h_{21}>56; f_T>250MГц$	B	E	C
R09	KSR1109	SAMS	D-NPN	$V_{CB0}=40B; I_C=100mA; P_D=200mBT; h_{21}=100...600; f_T>250MГц$	B	E	C
R1	TN2010T	SIL	nMOS	$V_{DS}=200B; I_D=120mA; P_D=360mBT; g_f=300C_{M}; R_{DS(ON)}=9.5O_M$	G	S	D
R10	KSR1110	SAMS	NPN	$V_{CB0}=40B; I_C=100mA; P_D=200mBT; h_{21}=100...600; f_T>250MГц$	B	E	C
R11	KSR1111	SAMS	NPN	$V_{CB0}=40B; I_C=100mA; P_D=200mBT; h_{21}=100...600; f_T>250MГц$	B	E	C
R12	KSR1112	SAMS	NPN	$V_{CB0}=40B; I_C=100mA; P_D=200mBT; h_{21}=100...600; f_T>250MГц$	B	E	C
R13	KSR1113	SAMS	NPN	$V_{CB0}=50B; I_C=100mA; P_D=300mBT; h_{21}>56; f_T>250MГц$	B	E	C
R14	KSR1114	SAMS	NPN	$V_{CB0}=50B; I_C=100mA; P_D=300mBT; h_{21}>68; f_T>250MГц$	B	E	C
R1A	SST3904	ROHM	NPN	$V_{CB0}=60B; I_C=200mA; h_{21}=100...300; f_T>300MГц$	B	E	C
R1A	MMBT3904	VISH	NPN	$V_{CB0}=60B; I_C=100mA; P_D=200mBT; h_{21}=100...300; f_T>300MГц$	B	E	C
R1B	SST2222	ROHM	NPN	$V_{CB0}=60B; I_C=600mA; h_{21}=100...300; f_T>250MГц$	B	E	C
R1C	SST1130	ROHM	NPN	$V_{CB0}=30B; I_C=200mA; h_{21}=120...360$	B	E	C
R1C	SSTA20	ROHM	NPN	$V_{CB0}=40B; I_C=200mA; h_{21}>120; f_T>125MГц$	B	E	C
R1G	SSTA06	ROHM	NPN	$V_{CB0}=80B; I_C=500mA; h_{21}>100; f_T>100MГц$	B	E	C
R1G	MMBTA06	VISH	NPN	$V_{CB0}=80B; I_C=300mA; P_D=350mBT; h_{21}>50; f_T>100MГц$	B	E	C
R1H	SSTA05	ROHM	NPN	$V_{CB0}=60B; I_C=500mA; h_{21}>100; f_T>100MГц$	B	E	C
R1H	MMBTA05	VISH	NPN	$V_{CB0}=60B; I_C=30mA; P_D=350mBT; h_{21}>50; f_T>100MГц$	B	E	C
R1J	SST6427	ROHM	NPN	$V_{CB0}=40B; I_C=500mA; h_{21}=20000...200000$	B	E	C
R1K	SST6428	ROHM	NPN	$V_{CB0}=60B; I_C=200mA; h_{21}=250...650; f_T>100MГц$	B	E	C
R1M	SSTA13	ROHM	NPN	$V_{CB0}=30B; I_C=500mA; h_{21}>10000; f_T>125MГц$	B	E	C
R1M	MMBTA13	VISH	NPN	$V_{CB0}=30B; I_C=300mA; P_D=350mBT; h_{21}>10000; f_T>125MГц$	B	E	C
R1N	SSTA14	ROHM	NPN	$V_{CB0}=30B; I_C=500mA; h_{21}>20000; f_T>125MГц$	B	E	C
R1N	MMBTA14	VISH	NPN	$V_{CB0}=30B; I_C=300mA; P_D=350mBT; h_{21}>20000; f_T>125MГц$	B	E	C
R1P	SST2222A	ROHM	NPN	$V_{CB0}=75B; I_C=600mA; h_{21}=100...300; f_T>250MГц$	B	E	C
R1P	MMBT2222A	VISH	NPN	$V_{CB0}=50B; I_C=800mA; P_D=200mBT; h_{21}=100...300; f_T>200MГц$	B	E	C
R1Q	SST5088	ROHM	NPN	$V_{CB0}=35B; I_C=200mA; h_{21}=300...900; f_T>50MГц$	B	E	C
R1R	SST5089	ROHM	NPN	$V_{CB0}=30B; I_C=200mA; h_{21}=400...1200; f_T>50MГц$	B	E	C
R2	BFR93ALT1	MOT	NPN	$V_{CB0}=15B; I_C=35mA; P_D=306mBT; h_{21}>40; f_T>3000MГц$	B	E	C
R2A	SST3906	ROHM	PNP	$V_{CB0}=-40B; I_C=-200mA; h_{21}=100...300; f_T>250MГц$	B	E	C
R2A	MMBT3906	VISH	PNP	$V_{CB0}=-40B; I_C=-100mA; P_D=200mBT; h_{21}=100...300; f_T>250MГц$	B	E	C
R2B	SST2907	ROHM	PNP	$V_{CB0}=-60B; I_C=-600mA; h_{21}=100...300; f_T>200MГц$	B	E	C
R2C	MMSTA70	ROHM	PNP	$V_{CB0}=-60B; I_C=-200mA; h_{21}=160...400; f_T>125MГц$	B	E	C
R2F	SST2907A	ROHM	PNP	$V_{CB0}=-60B; I_C=-600mA; h_{21}=100...300; f_T>200MГц$	B	E	C
R2G	SSTA56	ROHM	PNP	$V_{CB0}=-80B; I_C=-500mA; h_{21}>100; f_T>50MГц$	B	E	C
R2H	SSTA55	ROHM	PNP	$V_{CB0}=-60B; I_C=-500mA; h_{21}>100; f_T>50MГц$	B	E	C
R2K	MMST8598	ROHM	PNP	$V_{CB0}=-60B; I_C=200mA; h_{21}=100...300; f_T>150MГц$	B	E	C
R2P	MMST5086	ROHM	PNP	$V_{CB0}=-50B; I_C=-200mA; h_{21}=150...500; f_T>40MГц$	B	E	C
R2Q	MMST5087	ROHM	PNP	$V_{CB0}=-50B; I_C=-200mA; h_{21}=250...800; f_T>40MГц$	B	E	C
R2s	BFR93A	SIEM	NPN	$V_{CB0}=20B; I_C=50mA; P_D=300mBT; h_{21}=50...200; f_T=5500MГц$	B	E	C
R2T	SST4403	ROHM	PNP	$V_{CB0}=-40B; I_C=-600mA; h_{21}=100...300; f_T>200MГц$	B	E	C
R2T	MMBT4403	VISH	PNP	$V_{CB0}=-40B; I_C=-800mA; P_D=200mBT; h_{21}=100...300; f_T>200MГц$	B	E	C
R2U	SSTA63	ROHM	PNP	$V_{CB0}=-30B; I_C=-300mA; h_{21}>5000; f_T>125MГц$	B	E	C
R2V	SSTA64	ROHM	PNP	$V_{CB0}=-30B; I_C=-300mA; h_{21}>10000; f_T>125MГц$	B	E	C
R2X	SST4401	ROHM	NPN	$V_{CB0}=60B; I_C=600mA; h_{21}=100...300; f_T>250MГц$	B	E	C
R2X	MMBT4401	VISH	NPN	$V_{CB0}=50B; I_C=800mA; P_D=200mBT; h_{21}=100...300; f_T>200MГц$	B	E	C
R2Z	SST4400	ROHM	NPN	$V_{CB0}=60B; I_C=600mA; h_{21}=50...150; f_T>200MГц$	B	E	C
R51	KSR2101	SAMS	D-PNP	$V_{CB0}=-50B; I_C=-100mA; P_D=200mBT; h_{21}>20; f_T>250MГц$	B	E	C
R52	KSR2102	SAMS	D-PNP	$V_{CB0}=-50B; I_C=-100mA; P_D=200mBT; h_{21}>30; f_T>250MГц$	B	E	C
R53	KSR2103	SAMS	D-PNP	$V_{CB0}=-50B; I_C=-100mA; P_D=200mBT; h_{21}>56; f_T>250MГц$	B	E	C
R54	KSR2104	SAMS	D-PNP	$V_{CB0}=-50B; I_C=-100mA; P_D=200mBT; h_{21}>68; f_T>250MГц$	B	E	C
R55	KSR2105	SAMS	D-PNP	$V_{CB0}=-50B; I_C=-100mA; P_D=200mBT; h_{21}>30; f_T>250MГц$	B	E	C
R56	KSR2106	SAMS	D-PNP	$V_{CB0}=-50B; I_C=-100mA; P_D=200mBT; h_{21}>68; f_T>250MГц$	B	E	C
R57	KSR2107	SAMS	D-PNP	$V_{CB0}=-50B; I_C=-100mA; P_D=200mBT; h_{21}>68; f_T>250MГц$	B	E	C

SOT23, SOD23 (продолжение)

Код	Типоминал	Фирма	Функция	Особенности	Цоколевка		
					1	2	3
R58	KSR2108	SAMS	D-PNP	$V_{CB0}=-50B; I_C=-100mA; P_D=200mBT; h_{21}>56; f_T>250MГц$	B	E	C
R59	KSR2109	SAMS	PNP	$V_{CB0}=-40B; I_C=-100mA; P_D=200mBT; h_{21}=100...600; f_T>250MГц$	B	E	C
R60	KSR2110	SAMS	PNP	$V_{CB0}=-40B; I_C=-100mA; P_D=200mBT; h_{21}=100...300; f_T>250MГц$	B	E	C
R61	KSR2111	SAMS	PNP	$V_{CB0}=-40B; I_C=-100mA; P_D=200mBT; h_{21}=100...300; f_T>250MГц$	B	E	C
R62	KSR2112	SAMS	PNP	$V_{CB0}=-40B; I_C=-100mA; P_D=200mBT; h_{21}=100...300; f_T>250MГц$	B	E	C
R63	KSR2113	SAMS	PNP	$V_{CB0}=-50B; I_C=-100mA; P_D=300mBT; h_{21}>68; f_T>250MГц$	B	E	C
R64	KSR2114	SAMS	PNP	$V_{CB0}=-50B; I_C=-100mA; P_D=300mBT; h_{21}>68; f_T>250MГц$	B	E	C
R65	SSTA65	ROHM	PNP	$V_{CB0}=-30B; I_C=-300mA; h_{21}>50000; f_T>100MГц$	B	E	C
R7s	BFR106	SIEM	NPN	$V_{CB0}=20B; I_C=100mA; P_D=700mBT; h_{21}=25...250; f_T=5000MГц$	B	E	C
R97	SST197	ROHM	NPN	$V_{CB0}=60B; I_C=200mA; I_D=250...700$	B	E	C
RA1	BAW56	VISH	2xSD	$V_R=100B; I_F=300mA; P_D=350mBT; t_{RR}<6нс$	K1	K2	A1 A2
RA4	BAV70	VISH	2xSD	$V_R=100B; I_F=300mA; P_D=350mBT; t_{RR}<6нс$	A1	A2	K1 K2
RA6	BAS16	VISH	SHD	$V_R=100B; I_F=500mA; P_D=350mBT; t_{RR}<4нс$	A	nc	K
RA7	BAV99	VISH	2xSD	$V_R=100B; I_F=300mA; P_D=350mBT; t_{RR}<6нс$	A1	K2	K1 A2
RAB	MMBD4448	VISH	SHD	$V_R=100B; I_F=500mA; P_D=350mBT; t_{RR}<4нс$	A	nc	K
RAF	SSTA29	ROHM	NPN	$V_{CB0}=100B; I_C=500mA; h_{21}>10000; f_T>125MГц$	B	E	C
Ras	BFQ81	SIEM	NPN	$V_{CB0}=25B; I_C=30mA; P_D=280mBT; h_{21}=50...200; f_T=5800MГц$	B	E	C
RAT	SSTA28	ROHM	NPN	$V_{CB0}=80B; I_C=500mA; h_{21}>10000; f_T>125MГц$	B	E	C
RAV	BAS16	VISH	SHD	$V_R=100B; I_F=500mA; P_D=350mBT; t_{RR}<4нс$	A	nc	K
RBA	BAV99	VISH	2xSD	$V_R=100B; I_F=300mA; P_D=350mBT; t_{RR}<6нс$	A1	K2	K1 A2
RBQ	SST7208	ROHM	NPN	$V_{CB0}=60B; I_C=100mA; h_{21}>100; f_T>180MГц$	B	E	C
RBR	SST6838	ROHM	NPN	$V_{CB0}=50B; I_C=200mA; h_{21}>100; f_T>50MГц$	B	E	C
RBs	BF771	SIEM	NPN	$V_{CB0}=20B; I_C=80mA; P_D=580mBT; h_{21}=50...200; f_T=8000MГц$	B	E	C
RCs	BFR193	SIEM	NPN	$V_{CB0}=20B; I_C=80mA; P_D=580mBT; h_{21}=50...200; f_T=8000MГц$	B	E	C
RDs	BFR180	SIEM	NPN	$V_{CB0}=10B; I_C=4mA; P_D=30mBT; h_{21}=30...200; f_T=6200MГц$	B	E	C
RFQ	SST6839	ROHM	PNP	$V_{CB0}=-50B; I_C=-200mA; h_{21}>100; f_T>50MГц$	B	E	C
RFs	BFR181	SIEM	NPN	$V_{CB0}=20B; I_C=20mA; P_D=175mBT; h_{21}=50...200; f_T=8000MГц$	B	E	C
RGs	BFR182	SIEM	NPN	$V_{CB0}=20B; I_C=35mA; P_D=250mBT; h_{21}=50...200; f_T=8000MГц$	B	E	C
RHs	BFR183	SIEM	NPN	$V_{CB0}=20B; I_C=65mA; P_D=450mBT; h_{21}=50...200; f_T=8000MГц$	B	E	C
RKs	BFR194	SIEM	PNP	$V_{CB0}=-20B; I_C=-100mA; P_D=700mBT; h_{21}=20...150; f_T=5000MГц$	B	E	C
RSR	SST5210	ROHM	NPN	$V_{CB0}=50B; I_C=200mA; h_{21}=200...600; f_T>30MГц$	B	E	C
RVZ	MMST4126	ROHM	PNP	$V_{CB0}=-25B; I_C=-200mA; h_{21}=120...360; f_T>250MГц$	B	E	C
RX7	SST6426	ROHM	NPN	$V_{CB0}=40B; I_C=500mA; h_{21}=300...300000$	B	E	C
RZC	SST4124	ROHM	NPN	$V_{CB0}=30B; I_C=200mA; h_{21}=120...360; f_T>300MГц$	B	E	C
RZQ	MMST7157	ROHM	PNP	$V_{CB0}=-60B; I_C=-200mA; h_{21}>100$	B	E	C
S0	HSMP-3880	HP	PIN	$I_F<1A; P_D<250mBT; V_{BR}>100B; R_S<6.5Om; C_D<0.40пФ;$	A	nc	K
S0	SST270	SIL	nFET	$V_{DS}=30B; P_D=350mBT; g_f=6mCm; I_{DSS}=2...15mA$	D	S	G
S1	BBY31	PHIL	BD	$V_R<30B; I_F<20mA; I_R<10mA; R_S<1.2Om; C_{1V}=16.5пФ; C_{28V}=1.6...2пФ$	A	nc	K
S1	SST271	SIL	nFET	$V_{DS}=30B; P_D=350mBT; I_{DSS}=6...50mA; g_f=0.5mCm;$	D	S	G
S1	BBY31	ZETEX	BD	$V_R<28B; C_{25V}=1.8...2пФ; C_{3V}/C_{25V}>5$	A	nc	K
S12	BBY39	PHIL	2xBD	$V_R<30B; I_F<20mA; C_{1V}=16.5пФ; C_{28V}=1.6...2пФ$	A1	A2	K1 K2
S13	BBY42	PHIL	BD	$V_R<30B; I_F<20mA; I_R<10mA; R_S<1Om; C_{1V}>31пФ; C_{28V}=2.4...3пФ$	A	nc	K
S14	BB901	PHIL	BD	$V_R<28B; I_F<20mA; I_R<10mA; R_S<3Om; C_{28V}<1.055пФ; C_{0.5V}/C_{28V}>12$	A	nc	K
S16	ZHCS1006	ZETEX	SHD	$V_R<60B; I_F<0.9mA; V_F(I_F=1A)<0.6B; I_R<100mA; C_D<17пФ; t_{RR}<12нс$	A	nc	K
s1A	SMBT3904	SIEM	NPN	$V_{CB0}=60B; I_C=200mA; P_D=330mBT; h_{21}=100...300; f_T>300MГц$	B	E	C
s1B	PXTA93	SIEM	PNP	$V_{CB0}=-200B; I_C=-500mA; P_D=1000mBT; h_{21}>40; f_T>50MГц$	B	E	C
s1B	SMBT2222	SIEM	NPN	$V_{CB0}=60B; I_C=600mA; P_D=330mBT; h_{21}=100...300; f_T>250MГц$	B	E	C
s1C	SMBTA20	SIEM	NPN	$V_{CB0}=40B; I_C=100mA; P_D=330mBT; h_{21}=40...400; f_T>125MГц$	B	E	C
s1D	SMBTA42	SIEM	NPN	$V_{CB0}=300B; I_C=500mA; P_D=360mBT; h_{21}>40; f_T>50MГц$	B	E	C
s1E	SMBTA43	SIEM	NPN	$V_{CB0}=200B; I_C=500mA; P_D=360mBT; h_{21}>40; f_T>50MГц$	B	E	C
s1G	SMBTA06	SIEM	NPN	$=V_{CB0}=80B; I_C=500mA; P_D=330mBT; h_{21}>100; f_T>100MГц$	B	E	C

SOT23, SOD23 (продолжение)

Код	Типоминал	Фирма	Функция	Особенности	Цоколевка		
					1	2	3
s1H	SMBTA05	SIEM	NPN	$V_{CB0}=60B; I_C=500mA; P_D=330mBT; h_{21}>100; f_T=100MГц$	B	E	C
s1K	SMBT6428	SIEM	NPN	$V_{CB0}=60B; I_C=200mA; P_D=330mBT; h_{21}=250...650; f_T=200MГц$	B	E	C
s1L	SMBT6429	SIEM	NPN	$V_{CB0}=55B; I_C=200mA; P_D=330mBT; h_{21}=500...1250; f_T=200MГц$	B	E	C
s1M	SMBTA13	SIEM	NPN	$V_{CB0}=30B; I_C=300mA; P_D=330mBT; h_{21}>5000; f_T>125MГц$	B	E	C
s1N	SMBTA14	SIEM	NPN	$V_{CB0}=30B; I_C=300mA; P_D=330mBT; h_{21}>10000; f_T>125MГц$	B	E	C
s1P	SMBT2222A	SIEM	NPN	$V_{CB0}=75B; I_C=600mA; P_D=330mBT; h_{21}=100...300; f_T>300MГц$	B	E	C
s1V	SMBT6427	SIEM	NPN	$V_{CB0}=40B; I_C=500mA; P_D=360mBT; h_{21}=20000...200000; f_T>130MГц$	B	E	C
S2	BBY40	PHIL	BD	$V_R<30B; I_F<20mA; I_R<10nA; R_S<0.70M; C_{3V}=26...32пФ; C_{25V}=4.3...6пФ$	A	nc	K
S2	BBY40	ZETEX	BD	$V_R<28B; C_{3V}=26...32пФ; C_{3V}/C_{25V}=5...6.5$	A	nc	K
S2	BBQ31	ZETEX	NPN	$V_{CB0}=30B; I_C=100mA; P_D=330mBT; h_{21}>20; f_T>600MГц$	B	E	C
s2A	SMBT3906	SIEM	PNP	$V_{CB0}=-40B; I_C=-200mA; P_D=330mBT; h_{21}=100...300; f_T>250MГц$	B	E	C
s2B	SMBT2907	SIEM	PNP	$V_{CB0}=-40B; I_C=-600mA; P_D=330mBT; h_{21}=100...300; f_T>200MГц$	B	E	C
s2C	SMBTA70	SIEM	PNP	$V_{CB0}=-40B; I_C=-100mA; P_D=330mBT; h_{21}=40...400; f_T>150MГц$	B	E	C
s2D	SMBTA92	SIEM	PNP	$V_{CB0}=300B; I_C=-500mA; P_D=360mBT; h_{21}>25; f_T>50MГц$	B	E	C
s2E	SMBTA93	SIEM	PNP	$V_{CB0}=-200B; I_C=-500mA; P_D=360mBT; h_{21}>25; f_T>50MГц$	B	E	C
s2F	SMBT2907A	SIEM	PNP	$V_{CB0}=-60B; I_C=-600mA; P_D=330mBT; h_{21}=100...300; f_T>200MГц$	B	E	C
s2G	SMBTA56	SIEM	PNP	$V_{CB0}=-80B; I_C=-500mA; P_D=330mBT; h_{21}>100; f_T=100MГц$	B	E	C
s2H	SMBTA55	SIEM	PNP	$V_{CB0}=-60B; I_C=-500mA; P_D=330mBT; h_{21}>100; f_T=100MГц$	B	E	C
s2P	SMBT5086	SIEM	PNP	$V_{CB0}=-50B; I_C=-50mA; P_D=330mBT; h_{21}=150...500; f_T>40MГц$	B	E	C
s2V	SMBTA64	SIEM	PNP	$V_{CB0}=-30B; I_C=-500mA; P_D=360mBT; h_{21}>10000; f_T>125MГц$	B	E	C
s2Q	SMBT5087	SIEM	PNP	$V_{CB0}=-50B; I_C=-50mA; P_D=330mBT; h_{21}=250...800; f_T>40MГц$	B	E	C
s2U	SMBTA63	SIEM	PNP	$V_{CB0}=-30B; I_C=-500mA; P_D=360mBT; h_{21}>5000; f_T>125MГц$	B	E	C
S3	BBY51	SIEM	2xBD	$V_R<7B; I_F<20mA; I_R<0.01мкА; C_{1V}=4.5...6.1пФ; C_{1V}/C_{4V}=1.55...2.2$	A1	A2	K1 K2
S3	BBQ31R	ZETEX	NPN	$V_{CB0}=30B; I_C=100mA; P_D=330mBT; h_{21}>20; f_T>600MГц$	B	E	C
S4	SST174	SIL	nFET	$V_{DS}=-30B; P_D=350mBT; I_{DSS}=-20...135mA; g_f=4.5MCM; C_D<2.5пФ; t_{RR}<15нс$	D	S	G
S4	BBQ31A	ZETEX	NPN	$V_{CB0}=30B; I_C=100mA; P_D=330mBT; h_{21}>100; f_T>600MГц$	B	E	C
S5	SST175	SIL	nFET	$V_{DS}=-30B; P_D=350mBT; I_{DSS}=7...70mA; g_f=4.5MCM; C_D<2.0пФ; t_{RR}<15нс$	D	S	G
S5	BBQ31AR	ZETEX	NPN	$V_{CB0}=30B; I_C=100mA; P_D=330mBT; h_{21}>100; f_T>600MГц$	B	E	C
S50	BS850	GS	pFET	$V_{DSS}=-60B; I_D=-250mA; P_D=310mBT; V_{GS}<20B$	G	S	D
s56	ZHCS506	ZETEX	SHD	$V_R<60B; I_F<0.5mA; V_F(I_F=0.5A)<0.63B; I_R<40мкА; C_D<20пФ; t_{RR}<10нс$	A	nc	K
s5A	SMBD6050	SIEM	DI	$V_R<70B; I_F<250mA; V_F(I_F=100mA)<1.1B; I_R<0.1мкА; C_D<2.5пФ; t_{RR}<10нс$	A	nc	K
s5B	SMBD6100	SIEM	2xDI	$V_R<70B; I_F<250mA; V_F(I_F=100mA)<1.1B; I_R<0.1мкА; C_D<2.5пФ; t_{RR}<15нс$	A1	A2	K1 K2
s5C	SMBD7000	SIEM	2xDI	$V_R<100B; I_F<200mA; V_F(I_F=100mA)<1.1B; I_R<0.5мкА; C_D<2.0пФ; t_{RR}<15нс$	A1	K2	K1 A2
s5D	SMBD914	SIEM	DI	$V_R<70B; I_F<250mA; V_F(I_F=100mA)<1.0B; I_R<0.025мкА; C_D<2.0пФ; t_{RR}<4нс$	A	nc	K
S5s	BBY52	SIEM	2xBD	$V_R<7B; I_F<20mA; I_R<0.01мкА; C_{1V}=1.1...2.5пФ; C_{1V}/C_{4V}=1.1...2.1$	A1	A2	K1 K2
S6	SST176	SIL	pFET	$V_{DS}=-30B; P_D=350mBT; I_{DSS}=2...350mA; g_f=4.5MCM; C_D<2.0пФ; t_{RR}<15нс$	D	S	G
S7	SST177	SIL	pFET	$V_{DS}=-30B; P_D=350mBT; I_{DSS}=-1.6...20mA; g_f=4.5MCM; C_D<2.0пФ; t_{RR}<15нс$	D	S	G
S70	BS870	GS	nFET	$V_{DSS}=60B; I_D=250mA; P_D=310mBT; V_{GS}<20B$	G	S	D
S72	2N7002	VISH	nFET	$V_{DSS}=60B; I_D=115mA; P_D=200mBT; V_{GS}<2.5B; C_{ICC}=60пФ$	G	S	D
S76	ZHCS756	ZETEX	SHD	$V_R<60B; I_F<0.75A; V_F(I_F=0.75A)<0.61B; I_R<100мкА; C_D<17пФ; t_{RR}<12нс$	A	nc	K
S7s	BBY53	SIEM	2xBD	$V_R<6B; I_F<20mA; I_R<0.01мкА; C_{1V}=4.8...5.8пФ; C_{2V}/C_{3V}=1.8...2.8$	A1	A2	K1 K2
S8	BAT15-04	SIEM	SHD	$V_R<4B; I_F<110mA; V_F(I_F=10mA)<0.48B; C_D<0.35пФ$	A	nc	K
SA	BSS123	ZETEX	nMOS	$V_{DS}=100B; I_D=170mA; P_D=330mBT; g_f=90MCM; R_{DS(ON)}=140M$	G	S	D
sA2	SMBD2836	SIEM	2xDI	$V_R<50B; I_F<200mA; V_F(I_F=100mA)<1.2B; I_R<0.1мкА; C_D<4пФ; t_{RR}<6нс$	K1	K2	A1 A2
sA3	SMBD2835	SIEM	2xDI	$V_R<30B; I_F<200mA; V_F(I_F=100mA)<1.2B; I_R<0.1мкА; C_D<4пФ; t_{RR}<6нс$	K1	K2	A1 A2
sA4	SMBD2838	SIEM	2xDI	$V_R<50B; I_F<200mA; V_F(I_F=100mA)<1.2B; I_R<0.1мкА; C_D<4пФ; t_{RR}<6нс$	A1	A2	K1 K2

SOT23, SOD23 (продолжение)

Код	Типономинал	Фирма	Функция	Особенности	Цоколевка		
					1	2	3
sA5	SMBD2837	SIEM	2xDI	$V_{R<}<30B$; $I_{F<}<200_{MA}$; $V_{F(I_{F=100_{MA}})}<1.2B$; $I_{R<}<0.1_{\mu A}$; $C_{D<}<4_{пФ}$; $t_{RR}<6_{нс}$	A1	A2	K1 K2
SA _s	BSS123	SIEM	nMOS	$V_{DS}=100B$; $I_{D}=170_{MA}$; $P_{D}=360_{MBT}$; $g_{F}=170_{MC_{M}}$; $R_{DS(ON)}=60_{OM}$	G	S	D
SB _s	BSS145	SIEM	nMOS	$V_{DS}=65B$; $I_{D}=220_{MA}$; $P_{D}=360_{MBT}$; $g_{F}=120_{MC_{M}}$; $R_{DS(ON)}=3.50_{OM}$	G	S	D
sC3	SMBD2837	SIEM	2xDI	$V_{CB0}=-25B$; $I_{C}=200_{MA}$; $P_{D}=330_{MBT}$; $h_{21}=120...360$; $f_{T}>300_{MГц}$	B	E	C
SD _s	BSS284	SIEM	pMOS	$V_{DS}=-50B$; $I_{D}=-130_{MA}$; $P_{D}=360_{MBT}$; $g_{F}=50_{MC_{M}}$; $R_{DS(ON)}=100_{OM}$	G	S	D
SF0	BB804	PHIL	2xBD	$V_{R<}<18B$; $I_{F<}<50_{MA}$; $I_{R<}<20_{HA}$; $R_{S}<0.2_{OM}$; $C_{2V}=42...43.5_{пФ}$; $C_{2V}/C_{8V}>1.65$	A1	A2	K1 K2
SF0	BB804F0	SIEM	2xBD	$V_{R<}<18B$; $I_{F<}<50_{MA}$; $I_{R<}<0.02_{\mu A}$; $R_{S}<0.2_{OM}$; $C_{2V}=42...43.5_{пФ}$; $C_{2V}/C_{8V}>1.65$	A1	A2	K1 K2
SF1	BB804	PHIL	2xBD	$V_{R<}<18B$; $I_{F<}<50_{MA}$; $I_{R<}<20_{HA}$; $C_{2V}=43...44.5_{пФ}$; $C_{2V}/C_{8V}>1.65$	A1	A2	K1 K2
SF1	BB804F1	SIEM	2xBD	$V_{R<}<18B$; $I_{F<}<50_{MA}$; $I_{R<}<0.02_{\mu A}$; $C_{2V}=43...44.5_{пФ}$; $C_{2V}/C_{8V}>1.65$	A1	A2	K1 K2
SF2	BB804	PHIL	2xBD	$V_{R<}<18B$; $I_{F<}<50_{MA}$; $I_{R<}<20_{HA}$; $R_{S}<0.2_{OM}$; $C_{2V}=44...45.5_{пФ}$; $C_{2V}/C_{8V}>1.65$	A1	A2	K1 K2
SF2	BB804F2	SIEM	2xBD	$V_{R<}<18B$; $I_{F<}<50_{MA}$; $I_{R<}<0.02_{\mu A}$; $C_{2V}=44...45.5_{пФ}$; $C_{2V}/C_{8V}>1.65$	A1	A2	K1 K2
SF3	BB804	PHIL	2xBD	$V_{R<}<18B$; $I_{F<}<50_{MA}$; $I_{R<}<20_{HA}$; $R_{S}<0.20_{OM}$; $C_{2V}=45...46.5_{пФ}$; $C_{2V}/C_{8V}>1.65$	A1	A2	K1 K2
SF3	BB804F3	SIEM	2xBD	$V_{R<}<18B$; $I_{F<}<50_{MA}$; $I_{R<}<0.02_{\mu A}$; $C_{2V}=45...46.5_{пФ}$; $C_{2V}/C_{8V}>1.65$	A1	A2	K1 K2
SF4	BB804F4	SIEM	2xBD	$V_{R<}<18B$; $I_{F<}<50_{MA}$; $I_{R<}<0.02_{\mu A}$; $C_{2V}=46...47.5_{пФ}$; $C_{2V}/C_{8V}>1.65$	A1	A2	K1 K2
SH1	BB814H1	SIEM	2xBD	$V_{R<}<18B$; $I_{F<}<50_{MA}$; $I_{R<}<0.02_{\mu A}$; $C_{2V}=43...45_{пФ}$; $C_{2V}/C_{8V}=2.05...2.25$	A1	A2	K1 K2
SH2	BB814H2	SIEM	2xBD	$V_{R<}<18B$; $I_{F<}<50_{MA}$; $I_{R<}<0.02_{\mu A}$; $C_{2V}=44.5...46.5_{пФ}$; $C_{2V}/C_{8V}=2.05...2.25$	A1	A2	K1 K2
SM _s	BB914	SIEM	2xBD	$V_{R<}<18B$; $I_{F<}<50_{MA}$; $I_{R<}<0.02_{\mu A}$; $C_{2V}=42.5...45_{пФ}$; $C_{2V}/C_{8V}=2.28...2.42$	A1	A2	K1 K2
SP	BSS84	ZETEX	pMOS	$V_{DS}=-50B$; $I_{D}=130_{MA}$; $P_{D}=360_{MBT}$; $g_{F}=50_{MC_{M}}$; $R_{DS(ON)}=100_{OM}$	G	S	D
SP _s	BSS84	SIEM	pMOS	$-V_{DS}=-50B$; $I_{D}=-130_{MA}$; $P_{D}=360_{MBT}$; $g_{F}>50_{MC_{M}}$; $R_{DS(ON)}<100_{OM}$	G	S	D
SR _s	BSS131	SIEM	nMOS	$V_{DS}=240B$; $I_{D}=100_{MA}$; $P_{D}=360_{MBT}$; $g_{F}=140_{MC_{M}}$; $R_{DS(ON)}=60_{OM}$	G	S	D
SS	BSS138	ZETEX	nMOS	$V_{DS}=50B$; $I_{D}=200_{MA}$; $P_{D}=360_{MBT}$; $g_{F}=120_{MC_{M}}$; $R_{DS(ON)}=60_{OM}$	G	S	D
sSF	SP0610T	SIEM	pMOS	$V_{DS}=-60B$; $I_{D}=-130_{MA}$; $P_{D}=360_{MBT}$; $g_{F}>80_{MC_{M}}$; $R_{DS(ON)}=100_{OM}$	G	S	D
sSH	BSS119	SIEM	nMOS	$V_{DS}=100B$; $I_{D}=170_{MA}$; $P_{D}=360_{MBT}$; $g_{F}>100_{MC_{M}}$; $R_{DS(ON)}=60_{OM}$	G	S	D
sSJ	BSS7728	SIEM	nMOS	$V_{DS}=60B$; $I_{D}=150_{MA}$; $P_{D}=360_{MBT}$; $g_{F}=80_{MC_{M}}$; $R_{DS(ON)}=7.50_{OM}$	G	S	D
SS _s	BSS138	SIEM	nMOS	$V_{DS}=50B$; $I_{D}=220_{MA}$; $P_{D}=360_{MBT}$; $g_{F}>120_{MC_{M}}$; $R_{DS(ON)}=3.50_{OM}$	G	S	D
ST _s	BSS139	SIEM	nMOS	$V_{DS}=250B$; $I_{D}=40_{MA}$; $P_{D}=360_{MBT}$; $g_{F}>50_{MC_{M}}$; $R_{DS(ON)}<100_{OM}$	G	S	D
sZC	SMBT4124	SIEM	NPN	$V_{CB0}=30B$; $I_{C}=200_{MA}$; $P_{D}=330_{MBT}$; $h_{21}=120...360$; $f_{T}>300_{MГц}$	B	E	C
T0	HSMS-2860	HP	SHD	$V_{BR}>5B$; $V_{F(I_{F=30_{MA}})}<0.6B$; $C_{T}<0.30_{пФ}$; $R_{D}=100_{OM}$	A	nc	K
T0	TP610T	SIL	pMOS	$V_{DS}=-60B$; $I_{D}=-120_{MA}$; $P_{D}=360_{MBT}$; $g_{F}=60_{MC_{M}}$; $R_{DS(ON)}<100_{OM}$	G	S	D
T1	BCX17	ALLEG	PNP	$V_{CB0}=-50B$; $I_{CB0}<100_{HA}$; $h_{21}=100...600$; $V_{CE(sat)}<0.62B$	B	E	C
T1	BCX17	CDIL	PNP	$V_{CB0}=-45B$; $I_{C}=-500_{MA}$; $P_{D}=250_{MBT}$; $h_{21}=100...600$; $f_{T}>100_{MГц}$	B	E	C
T1	HSMS-2862	HP	2xSHD	$V_{BR}>5B$; $V_{F(I_{F=30_{MA}})}<0.6B$; $C_{T}<0.30_{пФ}$; $R_{D}=100_{OM}$	A1	K2	K1 A2
T1	BCX17	ZETEX	PNP	$V_{CB0}=-50B$; $I_{C}=-500_{MA}$; $P_{D}=330_{MBT}$; $h_{21}=100...600$; $f_{T}>100_{MГц}$	B	E	C
T1p	BCX17	PHIL	PNP	$V_{CB0}=-45B$; $I_{C}=-500_{MA}$; $P_{D}=250_{MBT}$; $h_{21}=100...600$; $f_{T}>100_{MГц}$	B	E	C
T2	BCX18	ALLEG	PNP	$V_{CB0}=-30B$; $I_{CB0}<100_{HA}$; $h_{21}=100...600$; $V_{CE(sat)}<0.62B$	B	E	C
T2	BCX18	CDIL	PNP	$V_{CB0}=-25B$; $I_{C}=-500_{MA}$; $P_{D}=250_{MBT}$; $h_{21}=100...600$; $f_{T}>100_{MГц}$	B	E	C
T2	TN2460T	SIL	nMOS	$V_{DS}=240B$; $I_{D}=51_{MA}$; $P_{D}=360_{MBT}$; $g_{F}=70_{MC_{M}}$; $R_{DS(ON)}=110_{OM}$	G	S	D

SOT23, SOD23 (продолжение)

Код	Типоминал	Фирма	Функция	Особенности	Цоколевка		
					1	2	3
T2	BCX18	ZETEX	PNP	$V_{CB0}=-30B; I_C=-500mA; P_D=330mBт; h_{21}=100...600; f_T>100MГц$	B	E	C
T2p	BCX18	PHIL	PNP	$V_{CB0}=-25B; I_C=-500mA; P_D=250mBт; h_{21}=100...600; f_T=100MГц$	B	E	C
T3	HSMS-2863	HP	2xSHD	$V_{BR}>5B; V_F(I_F=30mA)<0.6B; C_T<0.30пФ; R_D=100M$	K1	K2	A1 A2
T35	BSR20	CDIL	PNP	$V_{CB0}=-130B; I_C=-600mA; P_D=250mBт; h_{21}>40; f_T=400MГц$	B	E	C
T35	BSR20	PHIL	PNP	$V_{CB0}=-130B; I_C=-600mA; P_D=250mBт; h_{21}>40; f_T=100...400MГц$	B	E	C
T36	BSR20A	CDIL	PNP	$V_{CB0}=-160B; I_C=-600mA; P_D=250mBт; h_{21}>60; f_T=300MГц$	B	E	C
T36	BSR20A	PHIL	PNP	$V_{CB0}=-160B; I_C=-600mA; P_D=250mBт; h_{21}>60; f_T=100...300MГц$	B	E	C
T4	HSMS-2864	HP	2xSHD	$V_{BR}>5B; V_F(I_F=30mA)<0.6B; C_T<0.30пФ; R_D=100M$	A1	A2	K1 K2
T4	BCX17R	ZETEX	PNP	$V_{CB0}=-50B; I_C=-500mA; P_D=330mBт; h_{21}=100...600; f_T>100MГц$	B	E	C
T5	BCX18R	ZETEX	PNP	$V_{CB0}=-30B; I_C=-500mA; P_D=330mBт; h_{21}=100...600; f_T>100MГц$	B	E	C
T7	BSR15	CDIL	PNP	$V_{CB0}=-60B; I_C=-600mA; P_D=250mBт; h_{21}>30; f_T>200MГц$	B	E	C
T7	SST4117	SIL	nFET	$V_{DS}=40B; P_D=350mBт; I_{DSS}=0.03...0.09mA; g_F=70mC_M$	D	S	G
T7p	BSR15	PHIL	PNP	$V_{CB0}=-60B; I_C=-600mA; P_D=250mBт; h_{21}>30; f_T>200MГц$	B	E	C
T8	BSR16	CDIL	PNP	$V_{CB0}=-60B; I_C=-600mA; P_D=250mBт; h_{21}>50; f_T>200MГц$	B	E	C
T8	SST4118	SIL	nFET	$V_{DS}=40B; P_D=350mBт; I_{DSS}=0.08...0.24mA; g_F=80mC_M$	D	S	G
T8p	BSR16	PHIL	PNP	$V_{CB0}=-60B; I_C=-600mA; P_D=250mBт; h_{21}>50; f_T>200MГц$	B	E	C
T9	SST4119	SIL	nFET	$V_{DS}=40B; P_D=350mBт; I_{DSS}=0.2...0.6mA; g_F=100mC_M$	D	S	G
T92	BSR18A	CDIL	PNP	$V_{CB0}=-40B; I_C=-200mA; P_D=250mBт; h_{21}=100...300; f_T>250MГц$	B	E	C
T92	BSR18A	PHIL	PNP	$V_{CB0}=-40B; I_C=-200mA; P_D=250mBт; h_{21}=100...300; f_T>250MГц$	B	E	C
TA	KTC3295A	KEC	NPN	$V_{CB0}=60B; I_C=150mA; P_D=150mBт; h_{21}=600...1800; f_T>250MГц$	B	E	C
TB	KTC3295B	KEC	NPN	$V_{CB0}=60B; I_C=150mA; P_D=150mBт; h_{21}=1200...3600; f_T>250MГц$	B	E	C
U1	BCX19	ALLEG	NPN	$V_{CB0}=50B; I_{CBO}<100HA; h_{21}=100...600; V_{CE(sat)}<0.62B$	B	E	C
U1	BCX19	CDIL	NPN	$V_{CB0}=45B; I_C=500mA; P_D=250mBт; h_{21}=100...600; f_T>100MГц$	B	E	C
U1	BCX19	ZETEX	NPN	$V_{CB0}=50B; I_C=500mA; P_D=330mBт; h_{21}=100...600; f_T>200MГц$	B	E	C
U1p	BCX19	PHIL	NPN	$V_{CB0}=45B; I_C=500mA; P_D=250mBт; h_{21}=100...600; f_T>100MГц$	B	E	C
U2	BCX20	ALLEG	NPN	$V_{CB0}=30B; I_{CBO}<100HA; h_{21}=100...600; V_{CE(sat)}<0.62B$	B	E	C
U2	BCX20	CDIL	PNP	$V_{CB0}=-25B; I_C=-500mA; P_D=250mBт; h_{21}=100...600; f_T>100MГц$	B	E	C
U2	BCX20	ZETEX	NPN	$V_{CB0}=30B; I_C=500mA; P_D=330mBт; h_{21}=100...600; f_T>200MГц$	B	E	C
U2p	BCX20	PHIL	PNP	$V_{CB0}=-25B; I_C=-500mA; P_D=250mBт; h_{21}=100...600; f_T>100MГц$	B	E	C
U35	BSR19	CDIL	NPN	$V_{CB0}=160B; I_C=600mA; P_D=250mBт; h_{21}>60; f_T=300$	B	E	C
U35	BSR19	PHIL	NPN	$V_{CB0}=160B; I_C=600mA; P_D=250mBт; h_{21}>60; f_T=300$	B	E	C
U36	BSR19A	CDIL	NPN	$V_{CB0}=180B; I_C=600mA; P_D=250mBт; h_{21}>80; f_T=300$	B	E	C
U36	BSR19A	PHIL	NPN	$V_{CB0}=180B; I_C=600mA; P_D=250mBт; h_{21}>80; f_T=300$	B	E	C
U4	BCX19R	ZETEX	NPN	$V_{CB0}=50B; I_C=500mA; P_D=330mBт; h_{21}=100...600; f_T>200MГц$	B	E	C
U5	BCX20R	ZETEX	NPN	$V_{CB0}=30B; I_C=500mA; P_D=330mBт; h_{21}=100...600; f_T>200MГц$	B	E	C
U7	BSR13	CDIL	NPN	$V_{CB0}=60B; I_C=800mA; P_D=250mBт; h_{21}=100...600; f_T>250MГц$	B	E	C
U7p	BSR13	PHIL	NPN	$V_{CB0}=60B; I_C=800mA; P_D=250mBт; h_{21}=100...600; f_T>250MГц$	B	E	C
U8	BSR14	CDIL	NPN	$V_{CB0}=75B; I_C=800mA; P_D=250mBт; h_{21}=100...600; f_T>300MГц$	B	E	C
U8p	BSR14	PHIL	NPN	$V_{CB0}=75B; I_C=800mA; P_D=250mBт; h_{21}=100...600; f_T>300MГц$	B	E	C
U92	BSR17R	CDIL	NPN	$V_{CB0}=60B; I_C=200mA; P_D=250mBт; h_{21}=100...600; f_T>300MГц$	B	E	C
U92	BSR17R	PHIL	NPN	$V_{CB0}=60B; I_C=200mA; P_D=350mBт; h_{21}=100...600; f_T>300MГц$	B	E	C
U9p	BSR17	PHIL	PNP	$V_{CB0}=-40B; I_C=-200mA; P_D=425mBт; h_{21}=40; f_T>300$	B	E	C
UF	BB801	SIEM	BD	$V_R<30B; I_F<50mA; I_R<0.02mA; C_{28V}=0.28...1.2пФ; C_{1V}/C_{28V}=7.8...9.5$	A	nc	K
V0	VP0610T	SIL	pMOS	$V_{DS}=-60B; I_D=120mA; P_D=360mBт; g_F=70mC_M; R_{DS(ON)}=100M$	G	S	D
V1	VN50300T	SIL	nMOS	$V_{DS}=500B; I_D=22mA; P_D=350mBт; g_F=140mC_M; R_{DS(ON)}=250M$	G	S	D
V1	DZ23C2V7	VISH	2xDZ	$V_Z=2.5...2.9B; Z_{ZT}(I_Z=5mA)=830M$	A1	A2	K1 K2
V10	DZ23C6V2	VISH	2xDZ	$V_Z=5.8...6.6B; Z_{ZT}(I_Z=5mA)=100M$	A1	A2	K1 K2
V11	DZ23C6V8	VISH	2xDZ	$V_Z=6.4...7.2B; Z_{ZT}(I_Z=5mA)=80M$	A1	A2	K1 K2
V12	DZ23C7V5	VISH	2xDZ	$V_Z=7.0...7.9B; Z_{ZT}(I_Z=5mA)=70M$	A1	A2	K1 K2

SOT23, SOD23 (продолжение)

Код	Типономинал	Фирма	Функция	Особенности	Цоколевка		
					1	2	3
V13	DZ23C8V2	VISH	2xDZ	$V_Z=7.7...8.7B; Z_{ZT}(I_Z=5mA)=70M$	A1	A2	K1 K2
V13	ZC932	ZETEX	BD	$V_R<12B; C_D(V_R=2.5B)=8.5...10.5 \text{ пФ}; C_{2V}/C_{20V}<3.1; Q>200$	A	nc	K
V14	DZ23C9V1	VISH	2xDZ	$V_Z=8.5...9.6B; Z_{ZT}(I_Z=5mA)=100M$	A1	A2	K1 K2
V14	ZC931	ZETEX	BD	$V_R<12B; C_D(V_R=2.5B)=8.5...10.5 \text{ пФ}; C_{2V}/C_{20V}<3.1; Q>200$	A	nc	K
V15	DZ23C10	VISH	2xDZ	$V_Z=9.4...10B; Z_{ZT}(I_Z=5mA)=150M$	A1	A2	K1 K2
V15	ZC930	ZETEX	BD	$V_R<25B; C_D(V_R=2.5B)=4.3...5.5 \text{ пФ}; C_{1V}/C_{4V}<3.0; Q>200$	A	nc	K
V16	DZ23C11	VISH	2xDZ	$V_Z=10.4...11B; Z_{ZT}(I_Z=5mA)=200M$	A1	A2	K1 K2
V16	ZC934	ZETEX	BD	$V_R<12B; C_D(V_R=2.5B)=40...65 \text{ пФ}; C_{1V}/C_{4V}<3.8; Q>80$	A	nc	K
V17	DZ23C12	VISH	2xDZ	$V_Z=11.4...12B; Z_{ZT}(I_Z=5mA)=200M$	A1	A2	K1 K2
V17	ZC933	ZETEX	BD	$V_R<12B; C_D(V_R=2.5B)=18...27 \text{ пФ}; C_{1V}/C_{4V}<3.5; Q>150$	A	nc	K
V18	DZ23C13	VISH	2xDZ	$V_Z=12.4...14B; Z_{ZT}(I_Z=5mA)=250M$	A1	A2	K1 K2
V19	DZ23C15	VISH	2xDZ	$V_Z=13.8...15B; Z_{ZT}(I_Z=5mA)=300M$	A1	A2	K1 K2
V2	VN0605T	SIL	nMOS	$V_{DS}=60B; I_D=180mA; P_D=360mBT; g_f=80mC_M; R_{DS(ON)}=500M$	G	S	D
V2	DZ23C3V0	VISH	2xDZ	$V_Z=2.8...3.2B; Z_{ZT}(I_Z=5mA)=950M$	A1	A2	K1 K2
V20	DZ23C16	VISH	2xDZ	$V_Z=15.3...17B; Z_{ZT}(I_Z=5mA)=400M$	A1	A2	K1 K2
V21	DZ23C18	VISH	2xDZ	$V_Z=16.8...19B; Z_{ZT}(I_Z=5mA)=500M$	A1	A2	K1 K2
V22	DZ23C20	VISH	2xDZ	$V_Z=18.8...21B; Z_{ZT}(I_Z=5mA)=500M$	A1	A2	K1 K2
V23	DZ23C22	VISH	2xDZ	$V_Z=20.8...23B; Z_{ZT}(I_Z=5mA)=550M$	A1	A2	K1 K2
V24	DZ23C24	VISH	2xDZ	$V_Z=22.8...25B; Z_{ZT}(I_Z=5mA)=800M$	A1	A2	K1 K2
V25	PMBT3640	PHIL	PNP	$V_{CB0}=-12B; I_C=80mA; P_D=350mBT; h_{21}=30...120; f_T>500MГц$	B	E	C
V25	DZ23C27	VISH	2xDZ	$V_Z=25.1...28B; Z_{ZT}(I_Z=2mA)=800M$	A1	A2	K1 K2
V26	DZ23C30	VISH	2xDZ	$V_Z=28...32B; Z_{ZT}(I_Z=2mA)=800M$	A1	A2	K1 K2
V27	DZ23C33	VISH	2xDZ	$V_Z=31...35B; Z_{ZT}(I_Z=2mA)=800M$	A1	A2	K1 K2
V28	DZ23C36	VISH	2xDZ	$V_Z=34...38B; Z_{ZT}(I_Z=2mA)=900M$	A1	A2	K1 K2
V29	DZ23C39	VISH	2xDZ	$V_Z=37...41B; Z_{ZT}(I_Z=2mA)=900M$	A1	A2	K1 K2
V3	DZ23C3V3	VISH	2xDZ	$V_Z=3.1...3.5B; Z_{ZT}(I_Z=5mA)=950M$	A1	A2	K1 K2
V30	DZ23C43	VISH	2xDZ	$V_Z=40...46B; Z_{ZT}(I_Z=2mA)=1000M$	A1	A2	K1 K2
V31	DZ23C47	VISH	2xDZ	$V_Z=44...50B; Z_{ZT}(I_Z=2mA)=1000M$	A1	A2	K1 K2
V32	DZ23C51	VISH	2xDZ	$V_Z=48...54B; Z_{ZT}(I_Z=2mA)=1000M$	A1	A2	K1 K2
V4	DZ23C3V6	VISH	2xDZ	$V_Z=3.4...3.8B; Z_{ZT}(I_Z=5mA)=950M$	A1	A2	K1 K2
V5	DZ23C3V9	VISH	2xDZ	$V_Z=3.7...4.1B; Z_{ZT}(I_Z=5mA)=950M$	A1	A2	K1 K2
V6	DZ23C4V3	VISH	2xDZ	$V_Z=4.0...4.6B; Z_{ZT}(I_Z=5mA)=950M$	A1	A2	K1 K2
V7	DZ23C4V7	VISH	2xDZ	$V_Z=4.4...5.0B; Z_{ZT}(I_Z=5mA)=780M$	A1	A2	K1 K2
V8	DZ23C5V1	VISH	2xDZ	$V_Z=4.8...5.4B; Z_{ZT}(I_Z=5mA)=600M$	A1	A2	K1 K2
V9	DZ23C5V6	VISH	2xDZ	$V_Z=5.2...6.0B; Z_{ZT}(I_Z=5mA)=400M$	A1	A2	K1 K2
W10	CMPZDA27V	CENTS	2xDZ	$V_Z(I_{ZT}=2.0mA)=25...29B; I_L(V_R=18.9B)<0.05mA; Z_{ZT}(I_{ZT}=2.0mA)<800M; I_{ZM}=6.2mA$	K2	K1	A2 A1
W11	CMPZDA30V	CENTS	2xDZ	$V_Z(I_{ZT}=2.0mA)=28...32B; I_L(V_R=21.0B)<0.05mA; Z_{ZT}(I_{ZT}=2.0mA)<800M; I_{ZM}=5.6mA$	K2	K1	A2 A1
W12	CMPZDA33V	CENTS	2xDZ	$V_Z(I_{ZT}=2.0mA)=31...35B; I_L(V_R=23.1B)<0.05mA; Z_{ZT}(I_{ZT}=2.0mA)<800M; I_{ZM}=5.0mA$	K2	K1	A2 A1
W1s	BFT92	SIEM	PNP	$V_{CB0}=-20B; I_C=-25mA; P_D=200mBT; h_{21}>20; f_T=5000MГц$	B	E	C

SOT23, SOD23 (продолжение)

Код	Типономинал	Фирма	Функция	Особенности	Цоколевка		
					1	2	3
W6	BZX84C3V3	CENTS	DZ	$V_Z(I_{ZT}=5mA)=3.1...3.5B$; $I_L(V_R=1.0B)<5.0мкА$; $Z_{ZT}(I_{ZT}=5mA)<95OM$; $I_{ZM}<76MA$	A	nc	K
W7	BZX84C3V6	CENTS	DZ	$V_Z(I_{ZT}=5mA)=3.4...3.8B$; $I_L(V_R=1.0B)<5.0мкА$; $Z_{ZT}(I_{ZT}=5mA)<90OM$; $I_{ZM}<69MA$	A	nc	K
W74	BAW74	ZETEX	2xDI	$V_R<50B$; $I_F<150MA$; $V_F(I_F=100MA)<1.0B$; $I_R<0.1мкА$; $C_D<2.0пФ$; $t_{RR}<4нс$	A1	A2	K1 K2
W8	BZX84C3V9	CENTS	DZ	$V_Z(I_{ZT}=5mA)=3.7...4.1B$; $I_L(V_R=1.0B)<3.0мкА$; $Z_{ZT}(I_{ZT}=5mA)<90OM$; $I_{ZM}<64MA$	A	nc	K
W9	BZX84C4V3	CENTS	DZ	$V_Z(I_{ZT}=5mA)=4.0...4.6B$; $I_L(V_R=1.0B)<3.0мкА$; $Z_{ZT}(I_{ZT}=5mA)<90OM$; $I_{ZM}<58MA$	A	nc	K
WCs	BCR133	SIEM	D-NPN	$V_{CB0}=50B$; $I_C=100MA$; $P_D=200мВт$; $h_{21}>30$; $f_T>130MГц$	B	E	C
WDs	BCR141	SIEM	D-NPN	$V_{CB0}=50B$; $I_C=100MA$; $P_D=200мВт$; $h_{21}>50$; $f_T>130MГц$	B	E	C
Wes	BCR148	SIEM	D-NPN	$V_{CB0}=50B$; $I_C=70MA$; $P_D=200мВт$; $h_{21}>70$; $f_T>100MГц$	B	E	C
WFs	BCR112	SIEM	D-NPN	$V_{CB0}=50B$; $I_C=100MA$; $P_D=200мВт$; $h_{21}>20$; $f_T>140MГц$	B	E	C
WGs	BCR116	SIEM	D-NPN	$V_{CB0}=50B$; $I_C=100MA$; $P_D=200мВт$; $h_{21}>70$; $f_T>160MГц$	B	E	C
WHs	BCR108	SIEM	D-NPN	$V_{CB0}=50B$; $I_C=100MA$; $P_D=200мВт$; $h_{21}>70$; $f_T>170MГц$	B	E	C
Wis	BCR158	SIEM	D-PNP	$V_{CB0}=-50B$; $I_C=-100MA$; $P_D=200мВт$; $h_{21}>70$; $f_T>200MГц$	B	E	C
WJs	BCR135	SIEM	D-NPN	$V_{CB0}=50B$; $I_C=100MA$; $P_D=200мВт$; $h_{21}>70$; $f_T>150MГц$	B	E	C
WKs	BCR119	SIEM	D-NPN	$V_{CB0}=50B$; $I_C=100MA$; $P_D=200мВт$; $h_{21}=120...630$; $f_T>150MГц$	B	E	C
WLs	BCR146	SIEM	D-NPN	$V_{CB0}=50B$; $I_C=70MA$; $P_D=200мВт$; $h_{21}>50$; $f_T>150MГц$	B	E	C
WMs	BCR183	SIEM	D-PNP	$V_{CB0}=-50B$; $I_C=-100MA$; $P_D=200мВт$; $h_{21}>30$; $f_T>200MГц$	B	E	C
WNs	BCR185	SIEM	D-PNP	$V_{CB0}=-50B$; $I_C=-100MA$; $P_D=200мВт$; $h_{21}>70$; $f_T>200MГц$	B	E	C
WOs	BCR191	SIEM	D-NPN	$V_{CB0}=-50B$; $I_C=-100MA$; $P_D=200мВт$; $h_{21}>50$; $f_T>200MГц$	B	E	C
WRs	BCR198	SIEM	D-PNP	$V_{CB0}=-50B$; $I_C=-70MA$; $P_D=200мВт$; $h_{21}>70$; $f_T>190MГц$	B	E	C
WSs	BCR169	SIEM	D-PNP	$V_{CB0}=-50B$; $I_C=-100MA$; $P_D=200мВт$; $h_{21}=120...630$; $f_T>200MГц$	B	E	C
WTs	BCR166	SIEM	D-PNP	$V_{CB0}=-50B$; $I_C=-100MA$; $P_D=200мВт$; $h_{21}>70$; $f_T>160MГц$	B	E	C
WUs	BCR162	SIEM	D-PNP	$V_{CB0}=-50B$; $I_C=-100MA$; $P_D=200мВт$; $h_{21}>20$; $f_T>200MГц$	B	E	C
WVs	BCR129	SIEM	D-NPN	$V_{CB0}=50B$; $I_C=100MA$; $P_D=200мВт$; $h_{21}=120...630$; $f_T>150MГц$	B	E	C
WW7	CMPZDA3V6	CENTS	2xDZ	$V_Z(I_{ZT}=5.0MA)=3.4...3.8B$; $I_L(V_R=1.0B)<2.0мкА$; $Z_{ZT}(I_{ZT}=5.0MA)<95OM$; $I_{ZM}=45MA$	K2	K1	A2 A1
WW8	CMPZDA3V9	CENTS	2xDZ	$V_Z(I_{ZT}=5.0MA)=3.7...4.1B$; $I_L(V_R=1.0B)<2.0мкА$; $Z_{ZT}(I_{ZT}=5.0MA)<90OM$; $I_{ZM}=43MA$	K2	K1	A2 A1
WW9	CMPZDA4V3	CENTS	2xDZ	$V_Z(I_{ZT}=5.0MA)=4.0...4.6B$; $I_L(V_R=1.0B)<1.0мкА$; $Z_{ZT}(I_{ZT}=5.0MA)<9OM$; $I_{ZM}=40MA$	K2	K1	A2 A1
WXs	BCR196	SIEM	D-PNP	$V_{CB0}=-50B$; $I_C=-70MA$; $P_D=200мВт$; $h_{21}>50$; $f_T>150MГц$	B	E	C
WZs	BCR142	SIEM	D-NPN	$V_{CB0}=50B$; $I_C=100MA$; $P_D=200мВт$; $h_{21}>70$; $f_T>150MГц$	B	E	C
X1s	BFT93	SIEM	D-PNP	$V_{CB0}=-15B$; $I_C=-35MA$; $P_D=300мВт$; $h_{21}>20$; $f_T>5500MГц$	B	E	C
XAs	BCR503	SIEM	D-NPN	$V_{CB0}=50B$; $I_C=500MA$; $P_D=330мВт$; $h_{21}>40$; $f_T>100MГц$	B	E	C
XBs	BCR553	SIEM	D-PNP	$V_{CB0}=-50B$; $I_C=-500MA$; $P_D=330мВт$; $h_{21}>40$; $f_T>150MГц$	B	E	C
XCs	BCR533	SIEM	D-NPN	$V_{CB0}=50B$; $I_C=500MA$; $P_D=330мВт$; $h_{21}>70$; $f_T>100MГц$	B	E	C
XDs	BCR555	SIEM	D-PNP	$V_{CB0}=-50B$; $I_C=-500MA$; $P_D=330мВт$; $h_{21}>70$; $f_T>150MГц$	B	E	C
XFs	BCR512	SIEM	D-NPN	$V_{CB0}=50B$; $I_C=500MA$; $P_D=330мВт$; $h_{21}>60$; $f_T>100MГц$	B	E	C
XGs	BCR523	SIEM	D-NPN	$V_{CB0}=50B$; $I_C=500MA$; $P_D=330мВт$; $h_{21}>70$; $f_T>100MГц$	B	E	C
XHs	BCR573	SIEM	D-PNP	$V_{CB0}=-50B$; $I_C=-500MA$; $P_D=330мВт$; $h_{21}>70$; $f_T>150MГц$	B	E	C
XKs	BCR519	SIEM	D-NPN	$V_{CB0}=50B$; $I_C=500MA$; $P_D=330мВт$; $h_{21}=120...630$; $f_T>100MГц$	B	E	C
XLs	BCR569	SIEM	D-PNP	$V_{CB0}=-50B$; $I_C=-500MA$; $P_D=330мВт$; $h_{21}=120...630$; $f_T>150MГц$	B	E	C
XMs	BCR583	SIEM	D-PNP	$V_{CB0}=-50B$; $I_C=-500MA$; $P_D=330мВт$; $h_{21}>70$; $f_T>150MГц$	B	E	C
XUs	BCR562	SIEM	D-PNP	$V_{CB0}=-50B$; $I_C=-500MA$; $P_D=330мВт$; $h_{21}>60$; $f_T>150MГц$	B	E	C
XVs	BCR521	SIEM	D-NPN	$V_{CB0}=50B$; $I_C=500MA$; $P_D=330мВт$; $h_{21}>20$; $f_T>100MГц$	B	E	C
XWs	BCR505	SIEM	D-NPN	$V_{CB0}=50B$; $I_C=500MA$; $P_D=330мВт$; $h_{21}>70$; $f_T>100MГц$	B	E	C
XXs	BCR571	SIEM	D-PNP	$V_{CB0}=-50B$; $I_C=-500MA$; $P_D=330мВт$; $h_{21}>20$; $f_T>150MГц$	B	E	C
Y1	BZX84C11	ALLEG	DZ	$V_Z(I_{ZT}=5MA)=10.4...11.6B$; $I_L(V_R=8.0B)<0.1мкА$; $Z_{ZT}(I_{ZT}=5MA)<20OM$	A	nc	K
Y1	BZX84C11	CENTS	DZ	$V_Z(I_{ZT}=5MA)=10.4...11.6B$; $I_L(V_R=8.0B)<0.1мкА$; $Z_{ZT}(I_{ZT}=5MA)<20OM$; $I_{ZM}<23MA$	A	nc	K
Y1	BZX84C11	VISH	DZ	$V_Z(I_{ZT}=5MA)=10.4...11.6B$; $Z_{ZT}(I_{ZT}=5MA)<20OM$	A	nc	K
Y10	BZX84C27	ALLEG	DZ	$V_Z(I_{ZT}=2MA)=25.1...28.9B$; $I_L(V_R=21.0B)<0.05мкА$; $Z_{ZT}(I_{ZT}=2MA)<80OM$	A	nc	K
Y10	BZX84C27	CENTS	DZ	$V_Z(I_{ZT}=2MA)=25.1...28.9B$; $I_L(V_R=18.9B)<0.05мкА$; $Z_{ZT}(I_{ZT}=2MA)<80OM$; $I_{ZM}<9MA$	A	nc	K
Y10	BZX84-C27	PHIL	DZ	$V_Z(I_{ZT}=2MA)=25.1...28.9B$; $I_L(V_R=18.9B)<50нА$; $Z_{ZT}(I_{ZT}=2.0MA)<80OM$; $I_{ZM}=200MA$	A	nc	K
Y10	BZX84C27	VISH	DZ	$V_Z(I_{ZT}=2MA)=25.1...28.9B$; $Z_{ZT}(I_{ZT}=2MA)<80OM$	A	nc	K
Y11	BZX84C30	ALLEG	DZ	$V_Z(I_{ZT}=2MA)=28.0...32.0B$; $I_L(V_R=18.9B)<0.05мкА$; $Z_{ZT}(I_{ZT}=2MA)<80OM$	A	nc	K

SOT23, SOD23 (продолжение)

Код	Типономинал	Фирма	Функция	Особенности	Цоколевка		
					1	2	3
Y11	BZX84C30	CENTS	DZ	$V_Z(I_{ZT}=2\text{mA})=28.0...32.0\text{B}$; $I_L(V_R=21.0\text{B})<0.05\text{мкА}$; $Z_{ZT}(I_{ZT}=2\text{mA})<800\text{M}$; $I_{ZM}<8\text{mA}$	A	nc	K
Y11	BZX84-C30	PHIL	DZ	$V_Z(I_{ZT}=2\text{mA})=28.0...32.0\text{B}$; $I_L(V_R=21.0\text{B})<50\text{нА}$; $Z_{ZT}(I_{ZT}=2.0\text{mA})<800\text{M}$; $I_{ZM}=200\text{mA}$	A	nc	K
Y11	BZX84C30	VISH	DZ	$V_Z(I_{ZT}=2\text{mA})=28.0...32.0\text{B}$; $Z_{ZT}(I_{ZT}=2\text{mA})<800\text{M}$	A	nc	K
Y12	BZX84C33	ALLEG	DZ	$V_Z(I_{ZT}=2\text{mA})=31.0...35.0\text{B}$; $I_L(V_R=23.1\text{B})<0.05\text{мкА}$; $Z_{ZT}(I_{ZT}=2\text{mA})<800\text{M}$	A	nc	K
Y12	BZX84C33	CENTS	DZ	$V_Z(I_{ZT}=2\text{mA})=31.0...35.0\text{B}$; $I_L(V_R=23.1\text{B})<0.05\text{мкА}$; $Z_{ZT}(I_{ZT}=2\text{mA})<800\text{M}$; $I_{ZM}<7\text{Ma}$	A	nc	K
Y12	BZX84-C33	PHIL	DZ	$V_Z(I_{ZT}=2\text{mA})=31.0...35.0\text{B}$; $I_L(V_R=23.1\text{B})<50\text{нА}$; $Z_{ZT}(I_{ZT}=2.0\text{mA})<800\text{M}$; $I_{ZM}=200\text{mA}$	A	nc	K
Y12	BZX84C33	VISH	DZ	$V_Z(I_{ZT}=2\text{mA})=31.0...35.0\text{B}$; $Z_{ZT}(I_{ZT}=2\text{mA})<800\text{M}$	A	nc	K
Y13	BZX84-C36	PHIL	DZ	$V_Z(I_{ZT}=2\text{mA})=34.0...38.0\text{B}$; $I_L(V_R=25.2\text{B})<50\text{нА}$; $Z_{ZT}(I_{ZT}=2.0\text{mA})<900\text{M}$; $I_{ZM}=200\text{mA}$	A	nc	K
Y13	BZX84C36	VISH	DZ	$V_Z(I_{ZT}=2\text{mA})=33.0...38.0\text{B}$; $Z_{ZT}(I_{ZT}=2\text{mA})<900\text{M}$	A	nc	K
Y14	BZX84-C39	PHIL	DZ	$V_Z(I_{ZT}=2\text{mA})=37.0...41.0\text{B}$; $I_L(V_R=27.3\text{B})<50\text{нА}$; $Z_{ZT}(I_{ZT}=2.0\text{mA})<750\text{M}$; $I_{ZM}=250\text{mA}$	A	nc	K
Y14	BZX84C39	VISH	DZ	$V_Z(I_{ZT}=2\text{mA})=36.0...41.0\text{B}$; $Z_{ZT}(I_{ZT}=2\text{mA})<1300\text{M}$	A	nc	K
Y15	BZX84-C43	PHIL	DZ	$V_Z(I_{ZT}=2\text{mA})=40.0...46.0\text{B}$; $I_L(V_R=30.1\text{B})<50\text{нА}$; $Z_{ZT}(I_{ZT}=2.0\text{mA})<1500\text{M}$; $I_{ZM}=200\text{mA}$	A	nc	K
Y15	BZX84C43	VISH	DZ	$V_Z(I_{ZT}=2\text{mA})=40.0...46.0\text{B}$; $Z_{ZT}(I_{ZT}=2\text{mA})<1500\text{M}$	A	nc	K
Y16	BZX84-C47	PHIL	DZ	$V_Z(I_{ZT}=2\text{mA})=44.0...50.0\text{B}$; $I_L(V_R=32.9\text{B})<50\text{нА}$; $Z_{ZT}(I_{ZT}=2.0\text{mA})<1700\text{M}$; $I_{ZM}=200\text{mA}$	A	nc	K
Y16	BZX84C47	VISH	DZ	$V_Z(I_{ZT}=2\text{mA})=44.0...50.0\text{B}$; $Z_{ZT}(I_{ZT}=2\text{mA})<1700\text{M}$	A	nc	K
Y17	BZX84-C51	PHIL	DZ	$V_Z(I_{ZT}=2\text{mA})=48.0...54.0\text{B}$; $I_L(V_R=35.7\text{B})<50\text{нА}$; $Z_{ZT}(I_{ZT}=2.0\text{mA})<1800\text{M}$; $I_{ZM}=200\text{mA}$	A	nc	K
Y17	BZX84C51	VISH	DZ	$V_Z(I_{ZT}=2\text{mA})=48.0...54.0\text{B}$; $Z_{ZT}(I_{ZT}=2\text{mA})<1800\text{M}$	A	nc	K
Y18	BZX84-C56	PHIL	DZ	$V_Z(I_{ZT}=2\text{mA})=52.0...60.0\text{B}$; $I_L(V_R=39.2\text{B})<50\text{нА}$; $Z_{ZT}(I_{ZT}=2.0\text{mA})<2000\text{M}$; $I_{ZM}=200\text{mA}$	A	nc	K
Y19	BZX84-C62	PHIL	DZ	$V_Z(I_{ZT}=2\text{mA})=58.0...66.0\text{B}$; $I_L(V_R=43.4\text{B})<50\text{нА}$; $Z_{ZT}(I_{ZT}=2.0\text{mA})<2150\text{M}$; $I_{ZM}=200\text{mA}$	A	nc	K
Y1p	BZX84-C11	PHIL	DZ	$V_Z(I_{ZT}=5\text{mA})=10.4...11.6\text{B}$; $I_L(V_R=8.0\text{B})<100\text{нА}$; $Z_{ZT}(I_{ZT}=5.0\text{mA})<200\text{M}$; $I_{ZM}=200\text{mA}$	A	nc	K
Y2	BZX84C12	ALLEG	DZ	$V_Z(I_{ZT}=5\text{mA})=11.4...12.7\text{B}$; $I_L(V_R=8.0\text{B})<0.1\text{мкА}$; $Z_{ZT}(I_{ZT}=5\text{mA})<250\text{M}$	A	nc	K
Y2	BZX84C12	CENTS	DZ	$V_Z(I_{ZT}=5\text{mA})=11.4...12.7\text{B}$; $I_L(V_R=8.0\text{B})<0.1\text{мкА}$; $Z_{ZT}(I_{ZT}=5\text{mA})<250\text{M}$; $I_{ZM}<21\text{mA}$	A	nc	K
Y2	BZX84C12	VISH	DZ	$V_Z(I_{ZT}=5\text{mA})=11.4...12.7\text{B}$; $Z_{ZT}(I_{ZT}=5\text{mA})<2500\text{M}$	A	nc	K
Y20	BZX84-C68	PHIL	DZ	$V_Z(I_{ZT}=2\text{mA})=64.60...72.0\text{B}$; $I_L(V_R=47.6\text{B})<50\text{нА}$; $Z_{ZT}(I_{ZT}=2.0\text{mA})<2400\text{M}$; $I_{ZM}=200\text{mA}$	A	nc	K
Y21	BZX84-C75	PHIL	DZ	$V_Z(I_{ZT}=2\text{mA})=70.0...79.0\text{B}$; $I_L(V_R=52.5\text{B})<50\text{нА}$; $Z_{ZT}(I_{ZT}=2.0\text{mA})<2550\text{M}$; $I_{ZM}=200\text{mA}$	A	nc	K
Y2p	BZX84-C12	PHIL	DZ	$V_Z(I_{ZT}=5\text{mA})=11.4...12.7\text{B}$; $I_L(V_R=8.0\text{B})<100\text{нА}$; $Z_{ZT}(I_{ZT}=5.0\text{mA})<250\text{M}$; $I_{ZM}=200\text{mA}$	A	nc	K
Y3	BZX84C13	ALLEG	DZ	$V_Z(I_{ZT}=5\text{mA})=12.4...14.1\text{B}$; $I_L(V_R=8.0\text{B})<0.1\text{мкА}$; $Z_{ZT}(I_{ZT}=5\text{mA})<300\text{M}$	A	nc	K
Y3	BZX84C13	CENTS	DZ	$V_Z(I_{ZT}=5\text{mA})=12.4...14.1\text{B}$; $I_L(V_R=8.0\text{B})<0.1\text{мкА}$; $Z_{ZT}(I_{ZT}=5\text{mA})<300\text{M}$; $I_{ZM}<19\text{mA}$	A	nc	K
Y3	BZX84C13	VISH	DZ	$V_Z(I_{ZT}=5\text{mA})=12.4...14.1\text{B}$; $Z_{ZT}(I_{ZT}=5\text{mA})<300\text{M}$	A	nc	K
Y3p	BZX84-C13	PHIL	DZ	$V_Z(I_{ZT}=5\text{mA})=12.4...14.1\text{B}$; $I_L(V_R=8.0\text{B})<100\text{нА}$; $Z_{ZT}(I_{ZT}=5.0\text{mA})<300\text{M}$; $I_{ZM}=200\text{mA}$	A	nc	K
Y4	BZX84C15	ALLEG	DZ	$V_Z(I_{ZT}=5\text{mA})=13.8...15.6\text{B}$; $I_L(V_R=10.5\text{B})<0.05\text{мкА}$; $Z_{ZT}(I_{ZT}=5\text{mA})<300\text{M}$	A	nc	K
Y4	BZX84C15	CENTS	DZ	$V_Z(I_{ZT}=5\text{mA})=13.8...15.6\text{B}$; $I_L(V_R=10.5\text{B})<0.05\text{мкА}$; $Z_{ZT}(I_{ZT}=5\text{mA})<300\text{M}$; $I_{ZM}<17\text{mA}$	A	nc	K
Y4	BZX84C15	VISH	DZ	$V_Z(I_{ZT}=5\text{mA})=13.8...15.6\text{B}$; $Z_{ZT}(I_{ZT}=5\text{mA})<300\text{M}$	A	nc	K
Y4p	BZX84-C15	PHIL	DZ	$V_Z(I_{ZT}=5\text{mA})=13.8...15.6\text{B}$; $I_L(V_R=10.5\text{B})<0.05\text{мкА}$; $Z_{ZT}(I_{ZT}=5.0\text{mA})<300\text{M}$; $I_{ZM}=200\text{mA}$	A	nc	K
Y5	BZX84C16	ALLEG	DZ	$V_Z(I_{ZT}=5\text{mA})=15.3...17.1\text{B}$; $I_L(V_R=11.2\text{B})<0.05\text{мкА}$; $Z_{ZT}(I_{ZT}=5\text{mA})<400\text{M}$	A	nc	K
Y5	BZX84C16	CENTS	DZ	$V_Z(I_{ZT}=5\text{mA})=15.3...17.1\text{B}$; $I_L(V_R=11.2\text{B})<0.05\text{мкА}$; $Z_{ZT}(I_{ZT}=5\text{mA})<400\text{M}$; $I_{ZM}<16\text{mA}$	A	nc	K
Y5	BZX84C16	VISH	DZ	$V_Z(I_{ZT}=5\text{mA})=15.3...17.1\text{B}$; $Z_{ZT}(I_{ZT}=5\text{mA})<400\text{M}$	A	nc	K
Y50	BZX84-A2V4	PHIL	DZ	$V_Z(I_{ZT}=5\text{mA})=2.37...2.43\text{B}$; $I_L(V_R=1.0\text{B})<50\text{мкА}$; $Z_{ZT}(I_{ZT}=5.0\text{mA})<1000\text{M}$; $I_{ZM}=200\text{mA}$	A	nc	K
Y51	BZX84-A2V7	PHIL	DZ	$V_Z(I_{ZT}=5\text{mA})=2.67...2.73\text{B}$; $I_L(V_R=1.0\text{B})<20\text{мкА}$; $Z_{ZT}(I_{ZT}=5.0\text{mA})<1000\text{M}$; $I_{ZM}=200\text{mA}$	A	nc	K
Y52	BZX84-A3V0	PHIL	DZ	$V_Z(I_{ZT}=5\text{mA})=2.97...3.03\text{B}$; $I_L(V_R=1.0\text{B})<10\text{мкА}$; $Z_{ZT}(I_{ZT}=5.0\text{mA})<950\text{M}$; $I_{ZM}=200\text{mA}$	A	nc	K
Y53	BZX84-A3V3	PHIL	DZ	$V_Z(I_{ZT}=5\text{mA})=3.26...3.34\text{B}$; $I_L(V_R=1.0\text{B})<5\text{мкА}$; $Z_{ZT}(I_{ZT}=5.0\text{mA})<950\text{M}$; $I_{ZM}=200\text{mA}$	A	nc	K
Y54	BZX84-A3V6	PHIL	DZ	$V_Z(I_{ZT}=5\text{mA})=3.56...3.64\text{B}$; $I_L(V_R=1.0\text{B})<5\text{мкА}$; $Z_{ZT}(I_{ZT}=5.0\text{mA})<900\text{M}$; $I_{ZM}=200\text{mA}$	A	nc	K

SOT23, SOD23 (продолжение)

Код	Типономинал	Фирма	Функция	Особенности	Цоколевка		
					1	2	3
Y55	BZX84-A3V9	PHIL	DZ	$V_Z(I_{ZT}=5\text{mA})=3.86...3.94\text{В}; I_L(V_R=1.0\text{В})<3\text{мкА}; Z_{ZT}(I_{ZT}=5.0\text{mA})<900\text{Ом}; I_{ZM}=200\text{mA}$	A	nc	K
Y56	BZX84-A4V3	PHIL	DZ	$V_Z(I_{ZT}=5\text{mA})=4.25...4.35\text{В}; I_L(V_R=1.0\text{В})<3\text{мкА}; Z_{ZT}(I_{ZT}=5.0\text{mA})<900\text{Ом}; I_{ZM}=200\text{mA}$	A	nc	K
Y57	BZX84-A4V7	PHIL	DZ	$V_Z(I_{ZT}=5\text{mA})=4.65...4.75\text{В}; I_L(V_R=2.0\text{В})<3\text{мкА}; Z_{ZT}(I_{ZT}=5.0\text{mA})<800\text{Ом}; I_{ZM}=200\text{mA}$	A	nc	K
Y58	BZX84-A5V1	PHIL	DZ	$V_Z(I_{ZT}=5\text{mA})=5.04...5.16\text{В}; I_L(V_R=2.0\text{В})<2\text{мкА}; Z_{ZT}(I_{ZT}=5.0\text{mA})<600\text{Ом}; I_{ZM}=200\text{mA}$	A	nc	K
Y59	BZX84-A5V6	PHIL	DZ	$V_Z(I_{ZT}=5\text{mA})=5.54...5.66\text{В}; I_L(V_R=2.0\text{В})<1\text{мкА}; Z_{ZT}(I_{ZT}=5.0\text{mA})<400\text{Ом}; I_{ZM}=200\text{mA}$	A	nc	K
Y5p	BZX84-C16	PHIL	DZ	$V_Z(I_{ZT}=5\text{mA})=15.3...17.1\text{В}; I_L(V_R=11.2\text{В})<50\text{нА}; Z_{ZT}(I_{ZT}=5.0\text{mA})<400\text{Ом}; I_{ZM}=200\text{mA}$	A	nc	K
Y6	BZX84C18	ALLEG	DZ	$V_Z(I_{ZT}=5\text{mA})=16.8...19.1\text{В}; I_L(V_R=12.6\text{В})<0.05\text{мкА}; Z_{ZT}(I_{ZT}=5\text{mA})<450\text{Ом}$	A	nc	K
Y6	BZX84C18	CENTS	DZ	$V_Z(I_{ZT}=5\text{mA})=16.8...19.1\text{В}; I_L(V_R=12.6\text{В})<0.05\text{мкА}; Z_{ZT}(I_{ZT}=5\text{mA})<450\text{Ом}; I_{ZM}<14\text{mA}$	A	nc	K
Y6	BZX84C18	VISH	DZ	$V_Z(I_{ZT}=5\text{mA})=16.8...19.1\text{В}; Z_{ZT}(I_{ZT}=5\text{mA})<450\text{Ом}$	A	nc	K
Y60	BZX84-A6V2	PHIL	DZ	$V_Z(I_{ZT}=5\text{mA})=6.13...6.27\text{В}; I_L(V_R=4.0\text{В})<3\text{мкА}; Z_{ZT}(I_{ZT}=5.0\text{mA})<100\text{Ом}; I_{ZM}=200\text{mA}$	A	nc	K
Y61	BZX84-A6V2	PHIL	DZ	$V_Z(I_{ZT}=5\text{mA})=6.73...6.87\text{В}; I_L(V_R=4.0\text{В})<2\text{мкА}; Z_{ZT}(I_{ZT}=5.0\text{mA})<150\text{Ом}; I_{ZM}=200\text{mA}$	A	nc	K
Y62	BZX84-A7V5	PHIL	DZ	$V_Z(I_{ZT}=5\text{mA})=7.42...7.58\text{В}; I_L(V_R=5.0\text{В})<1\text{мкА}; Z_{ZT}(I_{ZT}=5.0\text{mA})<150\text{Ом}; I_{ZM}=200\text{mA}$	A	nc	K
Y63	BZX84-A8V2	PHIL	DZ	$V_Z(I_{ZT}=5\text{mA})=8.11...8.29\text{В}; I_L(V_R=5.0\text{В})<700\text{нА}; Z_{ZT}(I_{ZT}=5.0\text{mA})<150\text{Ом}; I_{ZM}=200\text{mA}$	A	nc	K
Y64	BZX84-A9V1	PHIL	DZ	$V_Z(I_{ZT}=5\text{mA})=9.00...9.20\text{В}; I_L(V_R=6.0\text{В})<500\text{нА}; Z_{ZT}(I_{ZT}=5.0\text{mA})<150\text{Ом}; I_{ZM}=200\text{mA}$	A	nc	K
Y65	BZX84-A10	PHIL	DZ	$V_Z(I_{ZT}=5\text{mA})=9.9...10.1\text{В}; I_L(V_R=7.0\text{В})<200\text{нА}; Z_{ZT}(I_{ZT}=5.0\text{mA})<200\text{Ом}; I_{ZM}=200\text{mA}$	A	nc	K
Y66	BZX84-A11	PHIL	DZ	$V_Z(I_{ZT}=5\text{mA})=10.8...11.1\text{В}; I_L(V_R=8.0\text{В})<100\text{нА}; Z_{ZT}(I_{ZT}=5.0\text{mA})<200\text{Ом}; I_{ZM}=200\text{mA}$	A	nc	K
Y67	BZX84-A12	PHIL	DZ	$V_Z(I_{ZT}=5\text{mA})=11.88...12.12\text{В}; I_L(V_R=8.0\text{В})<100\text{нА}; Z_{ZT}(I_{ZT}=5.0\text{mA})<250\text{Ом}; I_{ZM}=200\text{mA}$	A	nc	K
Y68	BZX84-A13	PHIL	DZ	$V_Z(I_{ZT}=5\text{mA})=12.87...13.13\text{В}; I_L(V_R=8.0\text{В})<100\text{нА}; Z_{ZT}(I_{ZT}=5.0\text{mA})<300\text{Ом}; I_{ZM}=200\text{mA}$	A	nc	K
Y69	BZX84-A15	PHIL	DZ	$V_Z(I_{ZT}=5\text{mA})=14.9...15.2\text{В}; I_L(V_R=10.5\text{В})<0.05\text{мкА}; Z_{ZT}(I_{ZT}=5.0\text{mA})<300\text{Ом}; I_{ZM}=200\text{mA}$	A	nc	K
Y6p	BZX84-C16	PHIL	DZ	$V_Z(I_{ZT}=5\text{mA})=16.8...19.1\text{В}; I_L(V_R=12.6\text{В})<50\text{нА}; Z_{ZT}(I_{ZT}=5.0\text{mA})<450\text{Ом}; I_{ZM}=200\text{mA}$	A	nc	K
Y7	BZX84C20	ALLEG	DZ	$V_Z(I_{ZT}=5\text{mA})=18.8...21.1\text{В}; I_L(V_R=14.0\text{В})<0.05\text{мкА}; Z_{ZT}(I_{ZT}=5\text{mA})<550\text{Ом}$	A	nc	K
Y7	BZX84C20	CENTS	DZ	$V_Z(I_{ZT}=5\text{mA})=18.8...21.1\text{В}; I_L(V_R=14.0\text{В})<0.05\text{мкА}; Z_{ZT}(I_{ZT}=5\text{mA})<550\text{Ом}; I_{ZM}<12\text{mA}$	A	nc	K
Y7	BZX84C20	VISH	DZ	$V_Z(I_{ZT}=5\text{mA})=18.8...21.2\text{В}; Z_{ZT}(I_{ZT}=5\text{mA})<550\text{Ом}$	A	nc	K
Y70	BZX84-A16	PHIL	DZ	$V_Z(I_{ZT}=5\text{mA})=15.84...16.16\text{В}; I_L(V_R=11.2\text{В})<50\text{нА}; Z_{ZT}(I_{ZT}=5.0\text{mA})<400\text{Ом}; I_{ZM}=200\text{mA}$	A	nc	K
Y71	BZX84-A18	PHIL	DZ	$V_Z(I_{ZT}=5\text{mA})=17.8...18.2\text{В}; I_L(V_R=12.6\text{В})<50\text{нА}; Z_{ZT}(I_{ZT}=5.0\text{mA})<450\text{Ом}; I_{ZM}=200\text{mA}$	A	nc	K
Y72	BZX84-A20	PHIL	DZ	$V_Z(I_{ZT}=5\text{mA})=19.8...20.2\text{В}; I_L(V_R=14.0\text{В})<50\text{нА}; Z_{ZT}(I_{ZT}=5.0\text{mA})<550\text{Ом}; I_{ZM}=200\text{mA}$	A	nc	K
Y73	BZX84-A22	PHIL	DZ	$V_Z(I_{ZT}=5\text{mA})=21.8...22.2\text{В}; I_L(V_R=15.4\text{В})<50\text{нА}; Z_{ZT}(I_{ZT}=5.0\text{mA})<550\text{Ом}; I_{ZM}=200\text{mA}$	A	nc	K
Y74	BZX84-A24	PHIL	DZ	$V_Z(I_{ZT}=5\text{mA})=23.8...24.2\text{В}; I_L(V_R=16.8\text{В})<50\text{нА}; Z_{ZT}(I_{ZT}=5.0\text{mA})<300\text{Ом}; I_{ZM}=250\text{mA}$	A	nc	K
Y75	BZX84-A27	PHIL	DZ	$V_Z(I_{ZT}=2\text{mA})=26.7...27.3\text{В}; I_L(V_R=18.9\text{В})<50\text{нА}; Z_{ZT}(I_{ZT}=2.0\text{mA})<800\text{Ом}; I_{ZM}=200\text{mA}$	A	nc	K
Y76	BZX84-A30	PHIL	DZ	$V_Z(I_{ZT}=2\text{mA})=29.7...30.3\text{В}; I_L(V_R=21.0\text{В})<50\text{нА}; Z_{ZT}(I_{ZT}=2.0\text{mA})<800\text{Ом}; I_{ZM}=200\text{mA}$	A	nc	K
Y77	BZX84-A33	PHIL	DZ	$V_Z(I_{ZT}=2\text{mA})=32.7...33.3\text{В}; I_L(V_R=23.1\text{В})<50\text{нА}; Z_{ZT}(I_{ZT}=2.0\text{mA})<800\text{Ом}; I_{ZM}=200\text{mA}$	A	nc	K
Y78	BZX84-A36	PHIL	DZ	$V_Z(I_{ZT}=2\text{mA})=35.6...36.4\text{В}; I_L(V_R=25.2\text{В})<50\text{нА}; Z_{ZT}(I_{ZT}=2.0\text{mA})<900\text{Ом}; I_{ZM}=200\text{mA}$	A	nc	K
Y79	BZX84-A39	PHIL	DZ	$V_Z(I_{ZT}=2\text{mA})=38.6...39.4\text{В}; I_L(V_R=27.3\text{В})<50\text{нА}; Z_{ZT}(I_{ZT}=2.0\text{mA})<750\text{Ом}; I_{ZM}=250\text{mA}$	A	nc	K
Y7p	BZX84-C20	PHIL	DZ	$V_Z(I_{ZT}=5\text{mA})=18.8...21.2\text{В}; I_L(V_R=14.0\text{В})<50\text{нА}; Z_{ZT}(I_{ZT}=5.0\text{mA})<550\text{Ом}; I_{ZM}=200\text{mA}$	A	nc	K
Y8	BZX84C22	ALLEG	DZ	$V_Z(I_{ZT}=5\text{mA})=20.8...23.3\text{В}; I_L(V_R=15.4\text{В})<0.05\text{мкА}; Z_{ZT}(I_{ZT}=5\text{mA})<550\text{Ом};$	A	nc	K
Y8	BZX84C22	CENTS	DZ	$V_Z(I_{ZT}=5\text{mA})=20.8...23.3\text{В}; I_L(V_R=15.4\text{В})<0.05\text{мкА}; Z_{ZT}(I_{ZT}=5\text{mA})<550\text{Ом}; I_{ZM}<11\text{mA}$	A	nc	K
Y8	BZX84C22	VISH	DZ	$V_Z(I_{ZT}=5\text{mA})=20.8...23.3\text{В}; Z_{ZT}(I_{ZT}=5\text{mA})<550\text{Ом};$	A	nc	K
Y80	BZX84-A43	PHIL	DZ	$V_Z(I_{ZT}=2\text{mA})=42.6...43.4\text{В}; I_L(V_R=30.1\text{В})<50\text{нА}; Z_{ZT}(I_{ZT}=2.0\text{mA})<1500\text{Ом}; I_{ZM}=200\text{mA}$	A	nc	K

SOT23, SOD23 (продолжение)

Код	Типономинал	Фирма	Функция	Особенности	Цоколевка		
					1	2	3
Y81	BZX84-A47	PHIL	DZ	$V_Z(I_{ZT}=2mA)=46.5...47.5B$; $I_L(V_R=32.9B)<50\mu A$; $Z_{ZT}(I_{ZT}=2.0mA)<170\Omega$; $I_{ZM}=200mA$	A	nc	K
Y82	BZX84-A51	PHIL	DZ	$V_Z(I_{ZT}=2mA)=50.5...51.5B$; $I_L(V_R=35.7B)<50\mu A$; $Z_{ZT}(I_{ZT}=2.0mA)<180\Omega$; $I_{ZM}=200mA$	A	nc	K
Y83	BZX84-A56	PHIL	DZ	$V_Z(I_{ZT}=2mA)=55.4...56.6B$; $I_L(V_R=39.2B)<50\mu A$; $Z_{ZT}(I_{ZT}=2.0mA)<200\Omega$; $I_{ZM}=200mA$	A	nc	K
Y84	BZX84-A62	PHIL	DZ	$V_Z(I_{ZT}=2mA)=61.4...62.6B$; $I_L(V_R=43.4B)<50\mu A$; $Z_{ZT}(I_{ZT}=2.0mA)<215\Omega$; $I_{ZM}=200mA$	A	nc	K
Y85	BZX84-A68	PHIL	DZ	$V_Z(I_{ZT}=2mA)=67.3...68.7B$; $I_L(V_R=47.6B)<50\mu A$; $Z_{ZT}(I_{ZT}=2.0mA)<240\Omega$; $I_{ZM}=200mA$	A	nc	K
Y86	BZX84-A75	PHIL	DZ	$V_Z(I_{ZT}=2mA)=74.3...75.7B$; $I_L(V_R=52.5B)<50\mu A$; $Z_{ZT}(I_{ZT}=2.0mA)<255\Omega$; $I_{ZM}=200mA$	A	nc	K
Y8p	BZX84-C22	PHIL	DZ	$V_Z(I_{ZT}=5mA)=20.8...23.3B$; $I_L(V_R=15.4B)<50\mu A$; $Z_{ZT}(I_{ZT}=5.0mA)<55\Omega$; $I_{ZM}=200mA$	A	nc	K
Y9	BZX84C24	ALLEG	DZ	$V_Z(I_{ZT}=5mA)=22.8...25.6B$; $I_L(V_R=16.8B)<0.05mA$; $Z_{ZT}(I_{ZT}=5mA)<70\Omega$;	A	nc	K
Y9	BZX84C24	CENTS	DZ	$V_Z(I_{ZT}=5mA)=22.8...25.6B$; $I_L(V_R=16.8B)<0.05mA$; $Z_{ZT}(I_{ZT}=5mA)<70\Omega$; $I_{ZM}<10mA$	A	nc	K
Y9	BZX84C24	VISH	DZ	$V_Z(I_{ZT}=5mA)=22.8...25.6B$; $Z_{ZT}(I_{ZT}=5mA)<70\Omega$;	A	nc	K
Y9p	BZX84-C24	PHIL	DZ	$V_Z(I_{ZT}=5mA)=22.8...25.6B$; $I_L(V_R=16.8B)<50\mu A$; $Z_{ZT}(I_{ZT}=5.0mA)<30\Omega$; $I_{ZM}=200mA$	A	nc	K
YY1	CMPZDA11V	CENTS	2xDZ	$V_Z(I_{ZT}=5mA)=10.4...11.6B$; $I_L(V_R=8.0B)<0.1mA$; $Z_{ZT}(I_{ZT}=5.0mA)<20\Omega$; $I_{ZM}=15mA$	K2	K1	A2 A1
YY2	CMPZDA12V	CENTS	2xDZ	$V_Z(I_{ZT}=5mA)=11.4...12.7B$; $I_L(V_R=8.0B)<0.1mA$; $Z_{ZT}(I_{ZT}=5.0mA)<25\Omega$; $I_{ZM}=13mA$	K2	K1	A2 A1
YY3	CMPZDA13V	CENTS	2xDZ	$V_Z(I_{ZT}=5mA)=12.4...14.1B$; $I_L(V_R=8.0B)<0.1mA$; $Z_{ZT}(I_{ZT}=5.0mA)<30\Omega$; $I_{ZM}=12mA$	K2	K1	A2 A1
YY4	CMPZDA15V	CENTS	2xDZ	$V_Z(I_{ZT}=5mA)=13.8...15.6B$; $I_L(V_R=10.5B)<0.05mA$; $Z_{ZT}(I_{ZT}=5.0mA)<30\Omega$; $I_{ZM}=11mA$	K2	K1	A2 A1
YY5	CMPZDA16V	CENTS	2xDZ	$V_Z(I_{ZT}=5mA)=15.3...17.1B$; $I_L(V_R=11.2B)<0.05mA$; $Z_{ZT}(I_{ZT}=5.0mA)<40\Omega$; $I_{ZM}=10mA$	K2	K1	A2 A1
YY6	CMPZDA18V	CENTS	2xDZ	$V_Z(I_{ZT}=5mA)=16.8...19.1B$; $I_L(V_R=12.6B)<0.05mA$; $Z_{ZT}(I_{ZT}=5.0mA)<45\Omega$; $I_{ZM}=9.2mA$	K2	K1	A2 A1
YY7	CMPZDA20V	CENTS	2xDZ	$V_Z(I_{ZT}=5mA)=18.8...21.2B$; $I_L(V_R=14.0B)<0.05mA$; $Z_{ZT}(I_{ZT}=5.0mA)<55\Omega$; $I_{ZM}=8.3mA$	K2	K1	A2 A1
YY8	CMPZDA22V	CENTS	2xDZ	$V_Z(I_{ZT}=5mA)=20.8...23.3B$; $I_L(V_R=15.4B)<0.05mA$; $Z_{ZT}(I_{ZT}=5.0mA)<55\Omega$; $I_{ZM}=7.6mA$	K2	K1	A2 A1
YY9	CMPZDA24V	CENTS	2xDZ	$V_Z(I_{ZT}=5mA)=22.8...25.6B$; $I_L(V_R=16.8B)<0.05mA$; $Z_{ZT}(I_{ZT}=5.0mA)<70\Omega$; $I_{ZM}=7.0mA$	K2	K1	A2 A1
ZO	SST310	SIL	nFET	$V_{DS}=25B$; $P_D=350mBT$; $I_{DSS}=24...60mA$; $g_f=10mC_M$	D	S	G
Z1	BZX84C4V7	ALLEG	DZ	$V_Z(I_{ZT}=5mA)=4.4...5.0B$; $I_L(V_R=2.0B)<3.0mA$; $Z_{ZT}(I_{ZT}=5mA)<80\Omega$;	A	nc	K
Z1	BZX84C4V7	CENTS	DZ	$V_Z(I_{ZT}=5mA)=4.4...5.0B$; $I_L(V_R=2.0B)<3.0mA$; $Z_{ZT}(I_{ZT}=5mA)<80\Omega$; $I_{ZM}<53mA$	A	nc	K
Z1	BZX84C4V7	VISH	DZ	$V_Z(I_{ZT}=5mA)=4.4...5.0B$; $Z_{ZT}(I_{ZT}=5mA)<80\Omega$;	A	nc	K
Z11	BZX84-C2V4	PHIL	DZ	$V_Z(I_{ZT}=5.0mA)=2.2...2.6B$; $I_L(V_R=1.0B)<50\mu A$; $Z_{ZT}(I_{ZT}=5.0mA)<100\Omega$; $I_{ZM}=200mA$	A	nc	K
Z12	BZX84-C2V7	PHIL	DZ	$V_Z(I_{ZT}=5.0mA)=2.5...2.9B$; $I_L(V_R=1.0B)<20\mu A$; $Z_{ZT}(I_{ZT}=5.0mA)<100\Omega$; $I_{ZM}=200mA$	A	nc	K
Z12	BZX84C2V7	VISH	DZ	$V_Z(I_{ZT}=5mA)=2.51...2.89B$; $Z_{ZT}(I_{ZT}=5mA)<100\Omega$;	A	nc	K
Z13	BZX84-C3V0	PHIL	DZ	$V_Z(I_{ZT}=5.0mA)=2.8...3.2B$; $I_L(V_R=1.0B)<10\mu A$; $Z_{ZT}(I_{ZT}=5.0mA)<95\Omega$; $I_{ZM}=200mA$	A	nc	K
Z13	BZX84C3V0	VISH	DZ	$V_Z(I_{ZT}=5.0mA)=2.8...3.2B$; $Z_{ZT}(I_{ZT}=5.0mA)<100\Omega$;	A	nc	K
Z14	BZX84-C3V3	PHIL	DZ	$V_Z(I_{ZT}=5.0mA)=3.1...3.5B$; $I_L(V_R=1.0B)<5\mu A$; $Z_{ZT}(I_{ZT}=5.0mA)<95\Omega$; $I_{ZM}=200mA$	A	nc	K
Z14	BZX84C3V3	VISH	DZ	$V_Z(I_{ZT}=5mA)=3.1...3.5B$; $Z_{ZT}(I_{ZT}=5mA)<95\Omega$;	A	nc	K
Z15	BZX84-C3V6	PHIL	DZ	$V_Z(I_{ZT}=5.0mA)=3.4...3.8B$; $I_L(V_R=1.0B)<5\mu A$; $Z_{ZT}(I_{ZT}=5.0mA)<90\Omega$; $I_{ZM}=200mA$	A	nc	K
Z15	BZX84C3V6	VISH	DZ	$V_Z(I_{ZT}=5mA)=3.4...3.8B$; $Z_{ZT}(I_{ZT}=5mA)<95\Omega$;	A	nc	K
Z16	BZX84-C3V9	PHIL	DZ	$V_Z(I_{ZT}=5.0mA)=3.7...4.1B$; $I_L(V_R=1.0B)<3\mu A$; $Z_{ZT}(I_{ZT}=5.0mA)<90\Omega$; $I_{ZM}=200mA$	A	nc	K
Z16	BZX84C3V9	VISH	DZ	$V_Z(I_{ZT}=5mA)=3.7...4.1B$; $Z_{ZT}(I_{ZT}=5mA)<90\Omega$;	A	nc	K
Z17	BZX84-C4V3	PHIL	DZ	$V_Z(I_{ZT}=5.0mA)=4.0...4.6B$; $I_L(V_R=1.0B)<3\mu A$; $Z_{ZT}(I_{ZT}=5.0mA)<90\Omega$; $I_{ZM}=200mA$	A	nc	K
Z17	BZX84C4V3	VISH	DZ	$V_Z(I_{ZT}=5mA)=4.0...4.6B$; $Z_{ZT}(I_{ZT}=5mA)<90\Omega$;	A	nc	K
Z1A	BC846A	ZETEX	NPN	$V_{CB0}=80B$; $I_C=100mA$; $P_D=330mBT$; $h_{21}=110...220$; $f_T>300MHz$	B	E	C
Z1E	BC847A	ZETEX	NPN	$V_{CB0}=50B$; $I_C=100mA$; $P_D=330mBT$; $h_{21}=110...220$; $f_T>300MHz$	B	E	C
Z1L	BC848C	ZETEX	NPN	$V_{CB0}=30B$; $I_C=100mA$; $P_D=330mBT$; $h_{21}=420...800$; $f_T>300MHz$	B	E	C

SOT23, SOD23 (продолжение)

Код	Типономинал	Фирма	Функция	Особенности	Цоколевка		
					1	2	3
Z1p	BZX84-C4V7	PHIL	DZ	$V_Z(I_{ZT}=5.0\text{mA})=4.4...5.0\text{B}$; $I_L(V_R=2.0\text{B})<3\text{мкА}$; $Z_{ZT}(I_{ZT}=5.0\text{mA})<80\text{Ом}$; $I_{ZM}=200\text{mA}$	A	nc	K
Z2	BZX84C5V1	ALLEG	DZ	$V_Z(I_{ZT}=5\text{mA})=4.8...5.4\text{B}$; $I_L(V_R=2.0\text{B})<2.0\text{мкА}$; $Z_{ZT}(I_{ZT}=5\text{mA})<60\text{Ом}$;	A	nc	K
Z2	BZX84C5V1	CENTS	DZ	$V_Z(I_{ZT}=5\text{mA})=4.8...5.4\text{B}$; $I_L(V_R=2.0\text{B})<2.0\text{мкА}$; $Z_{ZT}(I_{ZT}=5\text{mA})<60\text{Ом}$; $I_{ZM}<49\text{mA}$	A	nc	K
Z2	BZX84C5V1	VISH	DZ	$V_Z(I_{ZT}=5\text{mA})=4.8...5.4\text{B}$; $Z_{ZT}(I_{ZT}=5\text{mA})<60\text{Ом}$;	A	nc	K
Z2G	BC850C	ZETEX	NPN	$V_{CB0}=50\text{B}$; $I_C=100\text{mA}$; $P_D=330\text{мВт}$; $h_{21}=420...800$; $f_T>300\text{МГц}$	B	E	C
Z2p	BZX84-C5V1	PHIL	DZ	$V_Z(I_{ZT}=5.0\text{mA})=4.8...5.4\text{B}$; $I_L(V_R=2.0\text{B})<2\text{мкА}$; $Z_{ZT}(I_{ZT}=5.0\text{mA})<60\text{Ом}$; $I_{ZM}=200\text{mA}$	A	nc	K
Z2U	FMMTA63	ZETEX	NPN	$V_{CB0}=-30\text{B}$; $I_C=-500\text{mA}$; $P_D=330\text{мВт}$; $h_{21}=10000$; $f_T>125\text{МГц}$	B	E	C
Z2V	FMMTA64	ZETEX	NPN	$V_{CB0}=-30\text{B}$; $I_C=-500\text{mA}$; $P_D=330\text{мВт}$; $h_{21}=20000$; $f_T>125\text{МГц}$	B	E	C
Z3	BZX84C5V6	ALLEG	DZ	$V_Z(I_{ZT}=5\text{mA})=5.2...6.0\text{B}$; $I_L(V_R=2.0\text{B})<1.0\text{мкА}$; $Z_{ZT}(I_{ZT}=5\text{mA})<40\text{Ом}$;	A	nc	K
Z3	BZX84C5V6	CENTS	DZ	$V_Z(I_{ZT}=5\text{mA})=5.2...6.0\text{B}$; $I_L(V_R=2.0\text{B})<1.0\text{мкА}$; $Z_{ZT}(I_{ZT}=5\text{mA})<40\text{Ом}$; $I_{ZM}<45\text{mA}$	A	nc	K
Z3	BZX84C5V6	VISH	DZ	$V_Z(I_{ZT}=5\text{mA})=5.2...6.0\text{B}$; $Z_{ZT}(I_{ZT}=5\text{mA})<40\text{Ом}$;	A	nc	K
Z3B	BC856B	ZETEX	PNP	$V_{CB0}=-80\text{B}$; $I_C=-100\text{mA}$; $P_D=330\text{мВт}$; $h_{21}=220...475$; $f_T>150\text{МГц}$	B	E	C
Z3E	BC857A	ZETEX	PNP	$V_{CB0}=-50\text{B}$; $I_C=-100\text{mA}$; $P_D=330\text{мВт}$; $h_{21}=125...250$; $f_T>150\text{МГц}$	B	E	C
Z3p	BZX84-C5V6	PHIL	DZ	$V_Z(I_{ZT}=5.0\text{mA})=5.2...6.0\text{B}$; $I_L(V_R=2.0\text{B})<1\text{мкА}$; $Z_{ZT}(I_{ZT}=5.0\text{mA})<40\text{Ом}$; $I_{ZM}=200\text{mA}$	A	nc	K
Z4	BZX84C6V2	ALLEG	DZ	$V_Z(I_{ZT}=5\text{mA})=5.8...6.6\text{B}$; $I_L(V_R=4.0\text{B})<3.0\text{мкА}$; $Z_{ZT}(I_{ZT}=5\text{mA})<100\text{Ом}$;	A	nc	K
Z4	BZX84C6V2	CENTS	DZ	$V_Z(I_{ZT}=5\text{mA})=5.8...6.6\text{B}$; $I_L(V_R=4.0\text{B})<3.0\text{мкА}$; $Z_{ZT}(I_{ZT}=5\text{mA})<100\text{Ом}$; $I_{ZM}<40\text{mA}$	A	nc	K
Z4	BZX84C6V2	VISH	DZ	$V_Z(I_{ZT}=5\text{mA})=5.8...6.6\text{B}$; $Z_{ZT}(I_{ZT}=5\text{mA})<100\text{Ом}$;	A	nc	K
Z4A	BC859A	ZETEX	PNP	$V_{CB0}=-30\text{B}$; $I_C=-100\text{mA}$; $P_D=330\text{мВт}$; $h_{21}=125...250$; $f_T>300\text{МГц}$	B	E	C
Z4C	BC859C	ZETEX	PNP	$V_{CB0}=-30\text{B}$; $I_C=-100\text{mA}$; $P_D=330\text{мВт}$; $h_{21}=420...800$; $f_T>300\text{МГц}$	B	E	C
Z4E	BC860A	ZETEX	PNP	$V_{CB0}=-50\text{B}$; $I_C=-100\text{mA}$; $P_D=330\text{мВт}$; $h_{21}=125...250$; $f_T>300\text{МГц}$	B	E	C
Z4p	BZX84-C6V2	PHIL	DZ	$V_Z(I_{ZT}=5.0\text{mA})=5.8...6.6\text{B}$; $I_L(V_R=4.0\text{B})<3\text{мкА}$; $Z_{ZT}(I_{ZT}=5.0\text{mA})<100\text{Ом}$; $I_{ZM}=200\text{mA}$	A	nc	K
Z5	BZX84C6V8	ALLEG	DZ	$V_Z(I_{ZT}=5\text{mA})=6.4...7.2\text{B}$; $I_L(V_R=4.0\text{B})<2.0\text{мкА}$; $Z_{ZT}(I_{ZT}=5\text{mA})<150\text{Ом}$;	A	nc	K
Z5	BZX84C6V8	CENTS	DZ	$V_Z(I_{ZT}=5\text{mA})=6.4...7.2\text{B}$; $I_L(V_R=4.0\text{B})<2\text{мкА}$; $Z_{ZT}(I_{ZT}=5\text{mA})<150\text{Ом}$; $I_{ZM}<37\text{mA}$	A	nc	K
Z5	BZX84C6V8	VISH	DZ	$V_Z(I_{ZT}=5\text{mA})=6.4...7.2\text{B}$; $Z_{ZT}(I_{ZT}=5\text{mA})<150\text{Ом}$;	A	nc	K
Z50	BZX84-B2V4	PHIL	DZ	$V_Z(I_{ZT}=5\text{mA})=2.4...2.5\text{B}$; $I_L(V_R=1.0\text{B})<50\text{мкА}$; $Z_{ZT}(I_{ZT}=5.0\text{mA})<100\text{Ом}$; $I_{ZM}=200\text{mA}$	A	nc	K
Z51	BZX84-B2V7	PHIL	DZ	$V_Z(I_{ZT}=5\text{mA})=2.68...2.75\text{B}$; $I_L(V_R=1.0\text{B})<20\text{мкА}$; $Z_{ZT}(I_{ZT}=5.0\text{mA})<100\text{Ом}$; $I_{ZM}=200\text{mA}$	A	nc	K
Z52	BZX84-B3V0	PHIL	DZ	$V_Z(I_{ZT}=5\text{mA})=2.94...3.06\text{B}$; $I_L(V_R=1.0\text{B})<10\text{мкА}$; $Z_{ZT}(I_{ZT}=5.0\text{mA})<95\text{Ом}$; $I_{ZM}=200\text{mA}$	A	nc	K
Z53	BZX84-B3V3	PHIL	DZ	$V_Z(I_{ZT}=5\text{mA})=3.23...3.37\text{B}$; $I_L(V_R=1.0\text{B})<5\text{мкА}$; $Z_{ZT}(I_{ZT}=5.0\text{mA})<95\text{Ом}$; $I_{ZM}=200\text{mA}$	A	nc	K
Z54	BZX84-B3V6	PHIL	DZ	$V_Z(I_{ZT}=5\text{mA})=3.53...3.67\text{B}$; $I_L(V_R=1.0\text{B})<5\text{мкА}$; $Z_{ZT}(I_{ZT}=5.0\text{mA})<90\text{Ом}$; $I_{ZM}=200\text{mA}$	A	nc	K
Z55	BZX84-B3V9	PHIL	DZ	$V_Z(I_{ZT}=5\text{mA})=3.82...3.98\text{B}$; $I_L(V_R=1.0\text{B})<3\text{мкА}$; $Z_{ZT}(I_{ZT}=5.0\text{mA})<90\text{Ом}$; $I_{ZM}=200\text{mA}$	A	nc	K
Z56	BZX84-B4V3	PHIL	DZ	$V_Z(I_{ZT}=5\text{mA})=4.21...4.39\text{B}$; $I_L(V_R=1.0\text{B})<3\text{мкА}$; $Z_{ZT}(I_{ZT}=5.0\text{mA})<90\text{Ом}$; $I_{ZM}=200\text{mA}$	A	nc	K
Z57	BZX84-B4V7	PHIL	DZ	$V_Z(I_{ZT}=5\text{mA})=4.61...4.79\text{B}$; $I_L(V_R=2.0\text{B})<3\text{мкА}$; $Z_{ZT}(I_{ZT}=5.0\text{mA})<80\text{Ом}$; $I_{ZM}=200\text{mA}$	A	nc	K
Z58	BZX84-B5V1	PHIL	DZ	$V_Z(I_{ZT}=5\text{mA})=5.00...5.20\text{B}$; $I_L(V_R=2.0\text{B})<2\text{мкА}$; $Z_{ZT}(I_{ZT}=5.0\text{mA})<60\text{Ом}$; $I_{ZM}=200\text{mA}$	A	nc	K
Z59	BZX84-B5V6	PHIL	DZ	$V_Z(I_{ZT}=5\text{mA})=5.49...5.71\text{B}$; $I_L(V_R=2.0\text{B})<1\text{мкА}$; $Z_{ZT}(I_{ZT}=5.0\text{mA})<40\text{Ом}$; $I_{ZM}=200\text{mA}$	A	nc	K
Z5p	BZX84-C6V8	PHIL	DZ	$V_Z(I_{ZT}=5\text{mA})=6.4...7.20\text{B}$; $I_L(V_R=4.0\text{B})<2\text{мкА}$; $Z_{ZT}(I_{ZT}=5.0\text{mA})<150\text{Ом}$; $I_{ZM}=200\text{mA}$	A	nc	K
Z6	BZX84C7V5	ALLEG	DZ	$V_Z(I_{ZT}=5\text{mA})=7.0...7.9\text{B}$; $I_L(V_R=5.0\text{B})<1.0\text{мкА}$; $Z_{ZT}(I_{ZT}=5\text{mA})<150\text{Ом}$;	A	nc	K
Z6	BZX84C7V5	CENTS	DZ	$V_Z(I_{ZT}=5\text{mA})=7.0...7.9\text{B}$; $I_L(V_R=5.0\text{B})<1.0\text{мкА}$; $Z_{ZT}(I_{ZT}=5\text{mA})<150\text{Ом}$; $I_{ZM}<33\text{mA}$	A	nc	K
Z6	BZX84C7V5	VISH	DZ	$V_Z(I_{ZT}=5\text{mA})=7.0...7.9\text{B}$; $Z_{ZT}(I_{ZT}=5\text{mA})<150\text{Ом}$;	A	nc	K
Z60	BZX84-B6V2	PHIL	DZ	$V_Z(I_{ZT}=5\text{mA})=6.08...6.32\text{B}$; $I_L(V_R=4.0\text{B})<3\text{мкА}$; $Z_{ZT}(I_{ZT}=5.0\text{mA})<100\text{Ом}$; $I_{ZM}=200\text{mA}$	A	nc	K

SOT23, SOD23 (продолжение)

Код	Типономинал	Фирма	Функция	Особенности	Цоколевка		
					1	2	3
Z61	BZX84-B6V8	PHIL	DZ	$V_Z(I_{ZT}=5mA)=6.66...6.94B$; $I_L(V_R=4.0B)<2mA$; $Z_{ZT}(I_{ZT}=5.0mA)<150M$; $I_{ZM}=200mA$	A	nc	K
Z62	BZX84-B7V5	PHIL	DZ	$V_Z(I_{ZT}=5mA)=7.35...7.65B$; $I_L(V_R=5.0B)<1mA$; $Z_{ZT}(I_{ZT}=5.0mA)<150M$; $I_{ZM}=200mA$	A	nc	K
Z63	BZX84-B8V2	PHIL	DZ	$V_Z(I_{ZT}=5mA)=8.04...8.36B$; $I_L(V_R=5.0B)<700HA$; $Z_{ZT}(I_{ZT}=5.0mA)<150M$; $I_{ZM}=200mA$	A	nc	K
Z64	BZX84-B9V1	PHIL	DZ	$V_Z(I_{ZT}=5mA)=8.92...9.28B$; $I_L(V_R=6.0B)<500HA$; $Z_{ZT}(I_{ZT}=5.0mA)<150M$; $I_{ZM}=200mA$	A	nc	K
Z65	BZX84-B10	PHIL	DZ	$V_Z(I_{ZT}=5mA)=9.8...10.2B$; $I_L(V_R=7.0B)<200HA$; $Z_{ZT}(I_{ZT}=5.0mA)<200M$; $I_{ZM}=200mA$	A	nc	K
Z66	BZX84-B11	PHIL	DZ	$V_Z(I_{ZT}=5mA)=10.8...11.2B$; $I_L(V_R=8.0B)<100HA$; $Z_{ZT}(I_{ZT}=5.0mA)<200M$; $I_{ZM}=200mA$	A	nc	K
Z67	BZX84-B12	PHIL	DZ	$V_Z(I_{ZT}=5mA)=11.8...12.2B$; $I_L(V_R=8.0B)<100HA$; $Z_{ZT}(I_{ZT}=5.0mA)<250M$; $I_{ZM}=200mA$	A	nc	K
Z68	BZX84-B13	PHIL	DZ	$V_Z(I_{ZT}=5mA)=12.7...13.3B$; $I_L(V_R=8.0B)<100HA$; $Z_{ZT}(I_{ZT}=5.0mA)<300M$; $I_{ZM}=200mA$	A	nc	K
Z69	BZX84-B15	PHIL	DZ	$V_Z(I_{ZT}=5mA)=14.7...15.3B$; $I_L(V_R=10.5B)<0.05mA$; $Z_{ZT}(I_{ZT}=5.0mA)<300M$; $I_{ZM}=200mA$	A	nc	K
Z6p	BZX84-C7V5	PHIL	DZ	$V_Z(I_{ZT}=5mA)=7.0...7.9B$; $I_L(V_R=5.0B)<1mA$; $Z_{ZT}(I_{ZT}=5.0mA)<150M$; $I_{ZM}=200mA$	A	nc	K
Z7	BZX84C8V2	ALLEG	DZ	$V_Z(I_{ZT}=5mA)=7.7...8.7B$; $I_L(V_R=5.0B)<0.7mA$; $Z_{ZT}(I_{ZT}=5mA)<150M$;	A	nc	K
Z7	BZX84C8V2	CENTS	DZ	$V_Z(I_{ZT}=5mA)=7.7...8.9B$; $I_L(V_R=5.0B)<0.7mA$; $Z_{ZT}(I_{ZT}=5mA)<150M$; $I_{ZM}=30mA$	A	nc	K
Z7	BZX84C8V2	VISH	DZ	$V_Z(I_{ZT}=5mA)=7.7...8.9B$; $Z_{ZT}(I_{ZT}=5mA)<150M$;	A	nc	K
Z70	BZX84- B16	PHIL	DZ	$V_Z(I_{ZT}=5mA)=15.7...16.3B$; $I_L(V_R=11.2B)<50HA$; $Z_{ZT}(I_{ZT}=5.0mA)<400M$; $I_{ZM}=200mA$	A	nc	K
Z71	BZX84- B18	PHIL	DZ	$V_Z(I_{ZT}=5mA)=17.6...18.4B$; $I_L(V_R=11.2B)<50HA$; $Z_{ZT}(I_{ZT}=5.0mA)<450M$; $I_{ZM}=200mA$	A	nc	K
Z72	BZX84- B20	PHIL	DZ	$V_Z(I_{ZT}=5mA)=19.6...20.4B$; $I_L(V_R=14.0B)<50HA$; $Z_{ZT}(I_{ZT}=5.0mA)<550M$; $I_{ZM}=200mA$	A	nc	K
Z73	BZX84- B22	PHIL	DZ	$V_Z(I_{ZT}=5mA)=21.6...22.4B$; $I_L(V_R=15.4B)<50HA$; $Z_{ZT}(I_{ZT}=5.0mA)<550M$; $I_{ZM}=200mA$	A	nc	K
Z74	BZX84- B24	PHIL	DZ	$V_Z(I_{ZT}=5mA)=23.5...24.5B$; $I_L(V_R=16.8B)<50HA$; $Z_{ZT}(I_{ZT}=5.0mA)<300M$; $I_{ZM}=250mA$	A	nc	K
Z75	BZX84-B27	PHIL	DZ	$V_Z(I_{ZT}=2mA)=26.5...27.5B$; $I_L(V_R=18.9B)<50HA$; $Z_{ZT}(I_{ZT}=2.0mA)<800M$; $I_{ZM}=200mA$	A	nc	K
Z76	BZX84-B30	PHIL	DZ	$V_Z(I_{ZT}=2mA)=29.4...30.6B$; $I_L(V_R=21.0B)<50HA$; $Z_{ZT}(I_{ZT}=2.0mA)<800M$; $I_{ZM}=200mA$	A	nc	K
Z77	BZX84-B33	PHIL	DZ	$V_Z(I_{ZT}=2mA)=32.3...33.7B$; $I_L(V_R=23.1B)<50HA$; $Z_{ZT}(I_{ZT}=2.0mA)<800M$; $I_{ZM}=200mA$	A	nc	K
Z78	BZX84-B36	PHIL	DZ	$V_Z(I_{ZT}=2mA)=35.3...36.7B$; $I_L(V_R=25.2B)<50HA$; $Z_{ZT}(I_{ZT}=2.0mA)<900M$; $I_{ZM}=200mA$	A	nc	K
Z79	BZX84-B39	PHIL	DZ	$V_Z(I_{ZT}=2mA)=38.2...39.8B$; $I_L(V_R=27.3B)<50HA$; $Z_{ZT}(I_{ZT}=2.0mA)<750M$; $I_{ZM}=250mA$	A	nc	K
Z7p	BZX84-C8V2	PHIL	DZ	$V_Z(I_{ZT}=5mA)=7.7...8.7B$; $I_L(V_R=5.0B)<700HA$; $Z_{ZT}(I_{ZT}=5.0mA)<150M$; $I_{ZM}=200mA$	A	nc	K
Z8	BZX84C9V1	ALLEG	DZ	$V_Z(I_{ZT}=5mA)=8.5...9.6B$; $I_L(V_R=6.0B)<0.5mA$; $Z_{ZT}(I_{ZT}=5mA)<150M$;	A	nc	K
Z8	BZX84C9V1	CENTS	DZ	$V_Z(I_{ZT}=5mA)=8.5...9.6B$; $I_L(V_R=6.0B)<0.5mA$; $Z_{ZT}(I_{ZT}=5mA)<150M$; $I_{ZM}<27mA$	A	nc	K
Z8	SST308	SIL	nFET	$V_{DS}=25B$; $P_D=350mBT$; $I_{DSS}=12...60mA$; $g_f=8mC_M$	D	S	G
Z8	BZX84C9V1	VISH	DZ	$V_Z(I_{ZT}=5mA)=8.5...9.6B$; $Z_{ZT}(I_{ZT}=5mA)<150M$;	A	nc	K
Z80	BZX84- B43	PHIL	DZ	$V_Z(I_{ZT}=2mA)=42.1...43.9B$; $I_L(V_R=30.1B)<50HA$; $Z_{ZT}(I_{ZT}=2mA)<1500M$; $I_{ZM}=200mA$	A	nc	K
Z81	BZX84- B47	PHIL	DZ	$V_Z(I_{ZT}=2mA)=46.1...47.9B$; $I_L(V_R=32.9B)<50HA$; $Z_{ZT}(I_{ZT}=2mA)<1700M$; $I_{ZM}=200mA$	A	nc	K
Z82	BZX84- B51	PHIL	DZ	$V_Z(I_{ZT}=2mA)=50.0...52.0B$; $I_L(V_R=35.7B)<50HA$; $Z_{ZT}(I_{ZT}=2mA)<1800M$; $I_{ZM}=200mA$	A	nc	K
Z83	BZX84- B56	PHIL	DZ	$V_Z(I_{ZT}=2mA)=54.9...57.1B$; $I_L(V_R=39.2B)<50HA$; $Z_{ZT}(I_{ZT}=2mA)<2000M$; $I_{ZM}=200mA$	A	nc	K
Z84	BZX84- B62	PHIL	DZ	$V_Z(I_{ZT}=2mA)=60.8...63.2B$; $I_L(V_R=43.4B)<50HA$; $Z_{ZT}(I_{ZT}=2mA)<2150M$; $I_{ZM}=200mA$	A	nc	K
Z85	BZX84-B68	PHIL	DZ	$V_Z(I_{ZT}=2mA)=66.6...69.4B$; $I_L(V_R=47.6B)<50HA$; $Z_{ZT}(I_{ZT}=2mA)<2400M$; $I_{ZM}=200mA$	A	nc	K
Z86	BZX84-B75	PHIL	DZ	$V_Z(I_{ZT}=2mA)=73.5...76.5B$; $I_L(V_R=52.5B)<50HA$; $Z_{ZT}(I_{ZT}=2mA)<2550M$; $I_{ZM}=200mA$	A	nc	K
Z8p	BZX84-C9V1	PHIL	DZ	$V_Z(I_{ZT}=5mA)=8.5...9.6B$; $I_L(V_R=6.0B)<500HA$; $Z_{ZT}(I_{ZT}=5mA)<150M$; $I_{ZM}=200mA$	A	nc	K
Z9	BZX84C10	ALLEG	DZ	$V_Z(I_{ZT}=5mA)=9.4...10.6B$; $I_L(V_R=7.0B)<0.2mA$; $Z_{ZT}(I_{ZT}=5mA)<200M$	A	nc	K
Z9	SST309	SIL	nFET	$V_{DS}=25B$; $P_D=350mBT$; $I_{DSS}=12...30mA$; $g_f=10mC_M$	D	S	G
Z9	BZX84C10	VISH	DZ	$V_Z(I_{ZT}=5mA)=9.4...10.6B$; $Z_{ZT}(I_{ZT}=5mA)<200M$;	A	nc	K

SOT23, SOD23 (продолжение)

Код	Типономинал	Фирма	Функция	Особенности	Цоколевка		
					1	2	3
Z9p	BZX84-C10	PHIL	DZ	$V_Z(I_{ZT}=5_{MA})=9.4...10.6B$; $I_L(V_R=7.0B)<200_{HA}$; $Z_{ZT}(I_{ZT}=5_{MA})<200_{OM}$; $I_{ZM}=200_{MA}$	A	nc	K
ZA6	FMMD2838	ZETEX	2x FID	$V_R<75B$; $I_F<100_{MA}$; $V_F(I_F=50_{MA})<1.0B$; $I_R<0.1_{mKA}$; $C_D<4.0_{пФ}$; $t_{RR}<6_{HC}$	A1	A2	K1 K2
ZB	FMMD4123	ZETEX	NPN	$V_{CB0}=40B$; $I_C=200_{MA}$; $P_D=330_{MBT}$; $h_{21}=50...150$; $f_T>250_{MГц}$	B	E	C
ZC	KST4124	SAMS	NPN	$V_{CB0}=30B$; $I_C=200_{MA}$; $P_D=350_{MBT}$; $h_{21}=120...360$; $f_T>300_{MГц}$	B	E	C
ZC	FMMD4124	ZETEX	NPN	$V_{CB0}=30B$; $I_C=200_{MA}$; $P_D=330_{MBT}$; $h_{21}=120...360$; $f_T>300_{MГц}$	B	E	C
ZCA	KN3904S	KEC	NPN	$V_{CB0}=60B$; $I_C=200_{MA}$; $P_D=350_{MBT}$	B	E	C
ZD	KST4125	SAMS	PNP	$V_{CB0}=-30B$; $I_C=-200_{MA}$; $P_D=350_{MBT}$; $h_{21}=50...150$; $f_T>200_{MГц}$	B	E	C
ZD	FMMD4125	ZETEX	PNP	$V_{CB0}=-30B$; $I_C=-200_{MA}$; $P_D=330_{MBT}$; $h_{21}=50...150$; $f_T>200_{MГц}$	B	E	C
ZFD	BCV26	ZETEX	PNP	$V_{CB0}=-40B$; $I_C=-500_{MA}$; $P_D=330_{MBT}$; $h_{21}>100$; $f_T>200_{MГц}$	B	E	C
ZFE	BCV46	ZETEX	PNP	$V_{CB0}=-80B$; $I_C=-500_{MA}$; $P_D=330_{MBT}$; $h_{21}>400$; $f_T>200_{MГц}$	B	E	C
ZFF	BCV27	ZETEX	NPN	$V_{CB0}=40B$; $I_C=500_{MA}$; $P_D=330_{MBT}$; $h_{21}>100$; $f_T>170_{MГц}$	B	E	C
ZFG	BCV47	ZETEX	NPN	$V_{CB0}=80B$; $I_C=500_{MA}$; $P_D=330_{MBT}$; $h_{21}>400$; $f_T>170_{MГц}$	B	E	C
ZRA	KN3903S	KEC	NPN	$V_{CB0}=60B$; $I_C=200_{MA}$; $P_D=350_{MBT}$	B	E	C
ZS1	ZHCS1000	ZETEX	SHD	$V_R<40B$; $I_F<1A$; $V_F(I_F=1A)<0.425B$; $I_R<100_{mKA}$; $C_D<25_{пФ}$; $t_{RR}<12_{HC}$	A	nc	C
ZS5	ZHCS500	ZETEX	SHD	$V_R<40B$; $I_F<0.5A$; $V_F(I_F=0.5A)<0.55B$; $I_R<40_{mKA}$; $C_D<20_{пФ}$; $t_{RR}<10_{HC}$	A	nc	C
ZS7	ZHCS750	ZETEX	SHD	$V_R<40B$; $I_F<0.75A$; $V_F(I_F=0.75A)<0.49B$; $I_R<0.1_{mKA}$; $C_D<25_{пФ}$; $t_{RR}<12_{HC}$	A	nc	C
ZZ1	CMPZDA4V7	CENTS	2xDZ	$V_Z(I_{ZT}=5_{MA})=4.4...5.0B$; $I_L(V_R=2.0B)<3.0_{mKA}$; $Z_{ZT}(I_{ZT}=5_{MA})<80_{OM}$; $I_{ZM}=38_{MA}$	K2	K1	A2 A1
ZZ2	CMPZDA5V1	CENTS	2xDZ	$V_Z(I_{ZT}=5_{MA})=4.8...5.4B$; $I_L(V_R=2.0B)<2.0_{mKA}$; $Z_{ZT}(I_{ZT}=5_{MA})<60_{OM}$; $I_{ZM}=35_{MA}$	K2	K1	A2 A1
ZZ3	CMPZDA5V6	CENTS	2xDZ	$V_Z(I_{ZT}=5_{MA})=5.2...6.0B$; $I_L(V_R=2.0B)<1.0_{mKA}$; $Z_{ZT}(I_{ZT}=5_{MA})<40_{OM}$; $I_{ZM}=32_{MA}$	K2	K1	A2 A1
ZZ4	CMPZDA6V2	CENTS	2xDZ	$V_Z(I_{ZT}=5_{MA})=5.8...6.6B$; $I_L(V_R=4.0B)<3.0_{mKA}$; $Z_{ZT}(I_{ZT}=5_{MA})<100_{OM}$; $I_{ZM}=28_{MA}$	K2	K1	A2 A1
ZZ5	CMPZDA6V8	CENTS	2xDZ	$V_Z(I_{ZT}=5_{MA})=6.4...7.2B$; $I_L(V_R=4.0B)<2.0_{mKA}$; $Z_{ZT}(I_{ZT}=5_{MA})<150_{OM}$; $I_{ZM}=25_{MA}$	K2	K1	A2 A1
ZZ6	CMPZDA7V5	CENTS	2xDZ	$V_Z(I_{ZT}=5_{MA})=7.0...7.9B$; $I_L(V_R=5.0B)<1.0_{mKA}$; $Z_{ZT}(I_{ZT}=5_{MA})<150_{OM}$; $I_{ZM}=23_{MA}$	K2	K1	A2 A1
ZZ7	CMPZDA8V2	CENTS	2xDZ	$V_Z(I_{ZT}=5_{MA})=7.7...8.7B$; $I_L(V_R=5.0B)<0.7_{mKA}$; $Z_{ZT}(I_{ZT}=5_{MA})<150_{OM}$; $I_{ZM}=21_{MA}$	K2	K1	A2 A1
ZZ8	CMPZDA9V1	CENTS	2xDZ	$V_Z(I_{ZT}=5_{MA})=8.5...9.6B$; $I_L(V_R=6.0B)<0.5_{mKA}$; $Z_{ZT}(I_{ZT}=5_{MA})<150_{OM}$; $I_{ZM}=18_{MA}$	K2	K1	A2 A1
ZZ9	CMPZDA10V	CENTS	2xDZ	$V_Z(I_{ZT}=5_{MA})=9.4...10.6B$; $I_L(V_R=7.0B)<0.2_{mKA}$; $Z_{ZT}(I_{ZT}=5_{MA})<200_{OM}$; $I_{ZM}=16_{MA}$	K2	K1	A2 A1

SOT323
SC-70

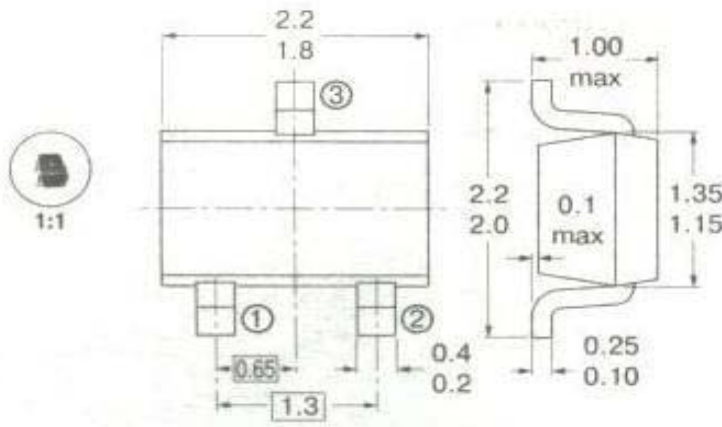

Код	Типономинал	Фирма	Функция	Особенности	Цоколевка		
					1	2	3
03	DTC143TUA	ROHM	D-NPN	$V_{CB0}=50B; I_C=100mA; P_D=200mBт; h_{21}=100...600; f_T>250MГц; R1=4.7kOM$	B	E	C
04	DTC114TUA	ROHM	D-NPN	$V_{CB0}=50B; I_C=100mA; P_D=200mBт; h_{21}=100...600; f_T>250MГц; R2=10kOM$	B	E	C
05	DTC124TUA	ROHM	D-NPN	$V_{CB0}=50B; I_C=100mA; P_D=200mBт; h_{21}=100...600; f_T>250MГц; R1=22kOM$	B	E	C
06	DTC144TUA	ROHM	D-NPN	$V_{CB0}=50B; I_C=100mA; P_D=200mBт; h_{21}=100...600; f_T>250MГц; R1=47kOM$	B	E	C
09	DTC115TUA	ROHM	D-NPN	$V_{CB0}=50B; I_C=100mA; P_D=200mBт; h_{21}=100...600; f_T>250MГц; R1=100kOM$	B	E	C
0A	DTC125TUA	ROHM	D-NPN	$V_{CB0}=50B; I_C=100mA; P_D=200mBт; h_{21}=100...600; f_T>250MГц; R1=200kOM$	B	E	C
10	MRF9411LT1	MOT	NPN	$V_{CB0}=20B; I_C=50mA; P_D=250mBт; h_{21}=50...200; f_T=8ГГц$	B	E	C
11	MRF9511LT1	MOT	NPN	$V_{CB0}=20B; I_C=100mA; P_D=322mBт; h_{21}=50...200; f_T=8ГГц$	B	E	C
12	DTA123EUA	ROHM	D-PNP	$V_{CB0}=-50B; I_C=-100mA; P_D=200mBт; h_{21}>20; f_T>250MГц; R1/R2=2.2/2.2kOM$	B	E	C
13	DTA143EUA	ROHM	D-PNP	$V_{CB0}=-50B; I_C=-100mA; P_D=200mBт; h_{21}>20; f_T>250MГц; R1/R2=4.7/4.7kOM$	B	E	C
13s	BAS125W	SIEM	D-SHD	$V_R<25B; I_F<100mA; V_F(I_F=35mA)<0.9B; I_R<0.15мкA; C_D<1.1пФ$	A	nc	K
14	DTA114EUA	ROHM	D-PNP	$V_{CB0}=-50B; I_C=-50mA; P_D=200mBт; h_{21}>30; f_T>250MГц; R1/R2=10/10kOM$	B	E	C
14s	BAS125-04W	SIEM	2xSHD	$V_R<25B; I_F<100mA; V_F(I_F=35mA)<0.9B; I_R<0.15мкA; C_D<1.1пФ$	A1	K2	K1 A2
15	DTA124EUA	ROHM	D-PNP	$V_{CB0}=-50B; I_C=-30mA; P_D=200mBт; h_{21}>56; f_T>250MГц; R1/R2=22/22kOM$	B	E	C
15s	BAS125-05W	SIEM	2xSHD	$V_R<25B; I_F<100mA; V_F(I_F=35mA)<0.9B; I_R<0.15мкA; C_D<1.1пФ$	A1	A2	K1 A2
16	DTA144EUA	ROHM	D-PNP	$V_{CB0}=-50B; I_C(max)=100mA; P_D=200mBт; h_{21}>68; f_T>250MГц; R1/R2=47/47kOM$	B	E	C
16s	BAS125-06W	SIEM	2xSHD	$V_R<25B; I_F<100mA; V_F(I_F=35mA)<0.9B; I_R<0.15мкA; C_D<1.1пФ$	K1	K2	A1 A2
19	DTA115EUA	ROHM	D-PNP	$V_{CB0}=-50B; I_C=-20mA; P_D=200mBт; h_{21}>82; f_T>250MГц; R1/R2=100/100kOM$	B	E	C
111	DTA113ZUA	ROHM	D-PNP	$V_{CB0}=-50B; I_C=-100mA; P_D=200mBт; h_{21}>33; f_T>250MГц; R1/R2=1/10kOM$	B	E	C
113	DTA143ZUA	ROHM	D-PNP	$V_{CB0}=-50B; I_C=-100mA; P_D=200mBт; h_{21}>80; f_T>250MГц; R1/R2=4.7/4.7kOM$	B	E	C
121	DTC113ZUA	ROHM	D-NPN	$V_{CB0}=50B; I_C=100mA; P_D=200mBт; h_{21}>33; f_T>250MГц; R1/R2=1/10kOM$	B	E	C
123	DTC143ZUA	ROHM	D-NPN	$V_{CB0}=50B; I_C=100mA; P_D=200mBт; h_{21}>80; f_T>250MГц; R1/R2=4.7/4.7kOM$	B	E	C
132	DTA123JUA	ROHM	D-PNP	$V_{CB0}=-50B; I_C=-100mA; P_D=200mBт; h_{21}>80; f_T>250MГц; R1/R2=2.2/47kOM$	B	E	C
142	DTC123JUA	ROHM	D-NPN	$V_{CB0}=50B; I_C=100mA; P_D=200mBт; h_{21}>80; f_T>250MГц; R1/R2=2.2/47kOM$	B	E	C
156	DTA144VUA	ROHM	D-PNP	$V_{CB0}=-50B; I_C=-100mA; P_D=200mBт; h_{21}>33; f_T>250MГц; R1/R2=47/10kOM$	B	E	C
166	DTC144VUA	ROHM	D-NPN	$V_{CB0}=50B; I_C=100mA; P_D=200mBт; h_{21}>33; f_T>250MГц; R1/R2=47/10kOM$	B	E	C
179	DTA115UU	ROHM	PNP	$V_{CB0}=-50B; I_C=-100mA; P_D=200mBт; h_{21}>27; f_T>250MГц; R1/R2=100/100kOM$	B	E	C
183	DTC115UU	ROHM	NPN	$V_{CB0}=50B; I_C=100mA; P_D=200mBт; h_{21}>27; f_T>250MГц; R1/R2=100/100kOM$	B	E	C
1A	BC846AW	PHIL	NPN	$V_{CB0}=80B; I_C=100mA; P_D=200mBт; h_{21}=110...220; f_T>100MГц; R1/R2=100/100kOM$	B	E	C
1A	BC846AWT1	MOT	NPN	$V_{CB0}=80B; I_C=100mA; P_D=300mBт; h_{21}=110...220; f_T>100MГц; R1/R2=100/100kOM$	B	E	C
1As	BC846AW	SIEM	NPN	$V_{CB0}=80B; I_C=100mA; P_D=250mBт; h_{21}=110...220; f_T>250MГц; R1/R2=100/100kOM$	B	E	C

SOT323 (продолжение)

Код	Типономинал	Фирма	Функция	Особенности	Цоколевка		
					1	2	3
1B	BC846BW	PHIL	NPN	$V_{CB0}=80B; I_C=100mA; P_D=200mBт; h_{21}=200...450;$ $f_T>100MГц;$	B	E	C
1Bs	BC846BW	SIEM	NPN	$V_{CB0}=80B; I_C=100mA; P_D=250mBт; h_{21}=200...450;$ $f_T=250MГц;$	B	E	C
1CL	2SC4082L	ROHM	NPN	$V_{CB0}=30B; I_C=50mA; P_D=150mBт; h_{21}=27...56; f_T=1500MГц;$	B	E	C
1CM	2SC4082M	ROHM	NPN	$V_{CB0}=30B; I_C=50mA; P_D=150mBт; h_{21}=39...82; f_T=1500MГц;$	B	E	C
1CN	2SC4082N	ROHM	NPN	$V_{CB0}=30B; I_C=50mA; P_D=150mBт; h_{21}=56...120; f_T=1500MГц;$	B	E	C
1CP	2SC4082P	ROHM	NPN	$V_{CB0}=30B; I_C=50mA; P_D=150mBт; h_{21}=82...180; f_T=1500MГц;$	B	E	C
1CQ	2SC4082Q	ROHM	NPN	$V_{CB0}=30B; I_C=50mA; P_D=150mBт; h_{21}=120...270;$ $f_T=1500MГц;$	B	E	C
1D	BC846W	PHIL	NPN	$V_{CB0}=80B; I_C=100mA; P_D=200mBт; h_{21}=110...450;$ $f_T>100MГц;$	B	E	C
1DL	2SC4083L	ROHM	NPN	$V_{CB0}=20B; I_C=50mA; P_D=150mBт; h_{21}=27...56; f_T=3200MГц;$	B	E	C
1DM	2SC4083M	ROHM	NPN	$V_{CB0}=20B; I_C=50mA; P_D=150mBт; h_{21}=39...82; f_T=3200MГц;$	B	E	C
1DN	2SC4083N	ROHM	NPN	$V_{CB0}=20B; I_C=50mA; P_D=150mBт; h_{21}=56...120; f_T=3200MГц;$	B	E	C
1DP	2SC4083P	ROHM	NPN	$V_{CB0}=20B; I_C=50mA; P_D=150mBт; h_{21}=82...180; f_T=3200MГц;$	B	E	C
1DQ	2SC4083Q	ROHM	NPN	$V_{CB0}=20B; I_C=50mA; P_D=150mBт; h_{21}=120...270;$ $f_T=3200MГц;$	B	E	C
1E	BC847AW	PHIL	NPN	$V_{CB0}=50B; I_C=100mA; P_D=200mBт; h_{21}=110...220; f_T>100MГц;$	B	E	C
1EL	2SC4084L	ROHM	NPN	$V_{CB0}=30B; I_C=50mA; P_D=150mBт; h_{21}=27...56; f_T>200MГц;$	B	E	C
1EM	2SC4084M	ROHM	NPN	$V_{CB0}=30B; I_C=50mA; P_D=150mBт; h_{21}=39...82; f_T>200MГц;$	B	E	C
1EN	2SC4084N	ROHM	NPN	$V_{CB0}=30B; I_C=50mA; P_D=150mBт; h_{21}=56...120; f_T>200MГц;$	B	E	C
1EP	2SC4084P	ROHM	NPN	$V_{CB0}=30B; I_C=50mA; P_D=150mBт; h_{21}=82...180; f_T>200MГц;$	B	E	C
1EQ	2SC4084Q	ROHM	NPN	$V_{CB0}=30B; I_C=50mA; P_D=150mBт; h_{21}=120...270; f_T>200MГц;$	B	E	C
1Es	BC847AW	SIEM	NPN	$V_{CB0}=50B; I_C=100mA; P_D=250mBт; h_{21}=110...220;$ $f_T>=250MГц;$	B	E	C
1F	BC847BW	PHIL	NPN	$V_{CB0}=50B; I_C=100mA; P_D=200mBт; h_{21}=200...450; f_T>100MГц;$	B	E	C
-1F	PMST5550	PHIL	NPN	$V_{CB0}=160B; I_C=600mA; P_D=200mBт; h_{21}=60...250; f_T=100...300$	B	E	C
1Fs	BC847BW	SIEM	NPN	$V_{CB0}=50B; I_C=100mA; P_D=250mBт; h_{21}=200...450; f_T=250MГц;$	B	E	C
1G	BC847CW	PHIL	NPN	$V_{CB0}=50B; I_C=100mA; P_D=200mBт; h_{21}=420...800; f_T>100MГц;$	B	E	C
1Gs	BC847BW	SIEM	NPN	$V_{CB0}=50B; I_C=100mA; P_D=250mBт; h_{21}=420...800; f_T=250MГц;$	B	E	C
1H	BC847W	PHIL	NPN	$V_{CB0}=50B; I_C=100mA; P_D=200mBт; h_{21}=110...800; f_T>100MГц;$	B	E	C
1J	BC848AW	PHIL	NPN	$V_{CB0}=30B; I_C=50mA; P_D=200mBт; h_{21}=110...220; f_T>100MГц;$	B	E	C
-1J	PMST2369	PHIL	NPN	$V_{CB0}=40B; I_C=500mA; P_D=200mBт; h_{21}=40...120$	B	E	C
1Js	BC848AW	SIEM	NPN	$V_{CB0}=30B; I_C=100mA; P_D=250mBт; h_{21}=110...220; f_T=250MГц;$	B	E	C
1K	BC848BW	PHIL	NPN	$V_{CB0}=30B; I_C=100mA; P_D=200mBт; h_{21}=200...450; f_T>100MГц;$	B	E	C
-1K	PMST6428	PHIL	NPN	$V_{CB0}=60B; I_C=200mA; P_D=200mBт; h_{21}=250...650;$ $f_T=100...700;$	B	E	C
1Ks	BC848BW	SIEM	NPN	$V_{CB0}=30B; I_C=100mA; P_D=250mBт; h_{21}=200...450; f_T=250MГц;$	B	E	C
1L	BC848CW	PHIL	NPN	$V_{CB0}=30B; I_C=100mA; P_D=200mBт; h_{21}=420...800; f_T>100MГц;$	B	E	C
-1L	PMST6429	PHIL	NPN	$V_{CB0}=55B; I_C=200mA; P_D=200mBт; h_{21}=500...1250;$ $f_T=100...700 MГц;$	B	E	C
1LM	2SC4103M	ROHM	NPN	$V_{CB0}=30B; I_C=30mA; P_D=200mBт; h_{21}=39...82; f_T>110MГц;$	B	E	C
1LN	2SC4103N	ROHM	NPN	$V_{CB0}=30B; I_C=30mA; P_D=200mBт; h_{21}=56...120; f_T>110MГц;$	B	E	C
1LP	2SC4103P	ROHM	NPN	$V_{CB0}=30B; I_C=30mA; P_D=200mBт; h_{21}=82...180; f_T>110MГц;$	B	E	C
1LQ	2SC4103Q	ROHM	NPN	$V_{CB0}=30B; I_C=30mA; P_D=200mBт; h_{21}=120...270; f_T>110MГц;$	B	E	C
1Ls	BC848CW	SIEM	NPN	$V_{CB0}=30B; I_C=100mA; P_D=250mBт; h_{21}=420...800; f_T=250MГц;$	B	E	C
1M	BC848W	PHIL	NPN	$V_{CB0}=30B; I_C=100mA; P_D=200mBт; h_{21}=110...800; f_T>100MГц;$	B	E	C
1MN	2SC4128N	ROHM	NPN	$V_{CB0}=40B; I_C=100mA; P_D=200mBт; h_{21}=56...120; f_T>230MГц;$	B	E	C
1MP	2SC4128P	ROHM	NPN	$V_{CB0}=40B; I_C=100mA; P_D=200mBт; h_{21}=82...180; f_T>230MГц;$	B	E	C
-1V	BF820W	PHIL	NPN	$V_{CB0}=300B; I_C=100mA; P_D=200mBт; h_{21}>50; f_T>60MГц;$	B	E	C
-1X	BF822W	PHIL	NPN	$V_{CB0}=250B; I_C=100mA; P_D=200mBт; h_{21}>50; f_T>60MГц;$	B	E	C
22	DTC123EUA	ROHM	D-NPN	$V_{CB0}=50B; I_C=100mA; P_D=200mBт; h_{21}>20; f_T>250MГц;$ $R1/R2=2.2/2.2kOm$	B	E	C
23	DTC143EUA	ROHM	D-NPN	$V_{CB0}=50B; I_C=100mA; P_D=200mBт; h_{21}>20; f_T>250MГц;$ $R1/R2=4.7/4.7kOm$	B	E	C
24	DTC114EUA	ROHM	D-NPN	$V_{CB0}=50B; I_C=100mA; P_D=200mBт; h_{21}>30; f_T>250MГц;$ $R1/R2=47/47kOm$	B	E	C
25	DTC124EUA	ROHM	D-NPN	$V_{CB0}=50B; I_C=30mA; P_D=200mBт; h_{21}>56; f_T>250MГц;$ $R1/R2=22/22kOm$	B	E	C
26	DTC144EUA	ROHM	D-NPN	$V_{CB0}=50B; I_C=30mA; P_D=200mBт; h_{21}>68; f_T>250MГц;$ $R1/R2=47/47kOm$	B	E	C
29	DTC115EUA	ROHM	D-NPN	$V_{CB0}=50B; I_C=30mA; P_D=200mBт; h_{21}>82; f_T>250MГц;$ $R1/R2=100/100kOm$	B	E	C
2B	BC849BW	PHIL	NPN	$V_{CB0}=30B; I_C=100mA; P_D=200mBт; h_{21}=200...450; f_T>100MГц;$	B	E	C
2Bs	BC849BW	SIEM	NPN	$V_{CB0}=30B; I_C=100mA; P_D=250mBт; h_{21}=200...450; f_T=250MГц;$	B	E	C
2C	BC849CW	PHIL	NPN	$V_{CB0}=30B; I_C=100mA; P_D=200mBт; h_{21}=420...800; f_T>100MГц;$	B	E	C
2Cs	BC849CW	SIEM	NPN	$V_{CB0}=30B; I_C=100mA; P_D=250mBт; h_{21}=420...800; f_T=250MГц;$	B	E	C
2D	BC849W	PHIL	NPN	$V_{CB0}=30B; I_C=100mA; P_D=200mBт; h_{21}=200...800; f_T>100MГц;$	B	E	C
2F	BC850BW	PHIL	NPN	$V_{CB0}=50B; I_C=100mA; P_D=200mBт; h_{21}=200...450; f_T>100MГц;$	B	E	C
2Fs	BC850BW	SIEM	NPN	$V_{CB0}=50B; I_C=100mA; P_D=250mBт; h_{21}=200...450; f_T=250MГц;$	B	E	C

SOT323 (продолжение)

Код	Типономинал	Фирма	Функция	Особенности	Цоколевка		
					1	2	3
2G	BC849CW	PHIL	NPN	$V_{CB0}=50B; I_C=100mA; P_D=200mBт; h_{21}=420...800; f_T>100MГц;$	B	E	C
2Gs	BC850CW	SIEM	NPN	$V_{CB0}=50B; I_C=100mA; P_D=250mBт; h_{21}=420...800; f_T=250MГц;$	B	E	C
2H	BC850W	PHIL	NPN	$V_{CB0}=50B; I_C=100mA; P_D=200mBт; h_{21}=200...800; f_T>100MГц;$	B	E	C
-2L	PMST5401	PHIL	PNP	$V_{CB0}=-16B; I_C=-500mA; P_D=200mBт; h_{21}=60...240; f_T=100...300MГц;$	B	E	C
33	DTA143XUA	ROHM	D-PNP	$V_{CB0}=-50B; I_C=-100mA; P_D=200mBт; h_{21}>30; f_T>250MГц; R1/R2=4.7/10kOm$	B	E	C
35	DTA124XUA	ROHM	D-PNP	$V_{CB0}=-50B; I_C=-100mA; P_D=200mBт; h_{21}>68; f_T>250MГц; R1/R2=22/47kOm$	B	E	C
3A	BC856AW	PHIL	PNP	$V_{CB0}=-80B; I_C=-100mA; P_D=200mBт; h_{21}=125...250; f_T>100MГц;$	B	E	C
3As	BC856AW	SIEM	PNP	$V_{CB0}=-80B; I_C=-100mA; P_D=250mBт; h_{21}=125...250; f_T=250MГц;$	B	E	C
3B	BC856BW	PHIL	PNP	$V_{CB0}=-80B; I_C=-100mA; P_D=200mBт; h_{21}=220...475; f_T>100MГц;$	B	E	C
3Bs	BC856BW	SIEM	PNP	$V_{CB0}=-80B; I_C=-100mA; P_D=250mBт; h_{21}=220...475; f_T=250MГц;$	B	E	C
3D	BC856W	PHIL	PNP	$V_{CB0}=-80B; I_C=-100mA; P_D=200mBт; h_{21}=125...800; f_T>100MГц;$	B	E	C
3E	BC857AW	PHIL	PNP	$V_{CB0}=-50B; I_C=-100mA; P_D=200mBт; h_{21}=125...250; f_T>100MГц;$	B	E	C
3Es	BC857AW	SIEM	PNP	$V_{CB0}=-50B; I_C=-100mA; P_D=250mBт; h_{21}=125...250; f_T=250MГц;$	B	E	C
3F	BC857BW	PHIL	PNP	$V_{CB0}=-50B; I_C=-100mA; P_D=200mBт; h_{21}=220...475; f_T>100MГц;$	B	E	C
3Fs	BC857BW	SIEM	PNP	$V_{CB0}=-50B; I_C=-100mA; P_D=250mBт; h_{21}=220...475; f_T=250MГц;$	B	E	C
3G	BC857CW	PHIL	PNP	$V_{CB0}=-50B; I_C=-100mA; P_D=200mBт; h_{21}=420...800; f_T>100MГц;$	B	E	C
3Gs	BC857CW	SIEM	PNP	$V_{CB0}=-50B; I_C=-100mA; P_D=250mBт; h_{21}=420...800; f_T=50MГц;$	B	E	C
3H	BC857W	PHIL	PNP	$V_{CB0}=-50B; I_C=-100mA; P_D=200mBт; h_{21}=125...800; f_T>100MГц;$	B	E	C
3J	BC858AW	PHIL	PNP	$V_{CB0}=-30B; I_C=-100mA; P_D=200mBт; h_{21}=125...250; f_T>100MГц;$	B	E	C
3Js	BC858AW	SIEM	PNP	$V_{CB0}=-30B; I_C=-100mA; P_D=250mBт; h_{21}=125...250; f_T=250MГц;$	B	E	C
3K	BC858BW	PHIL	PNP	$V_{CB0}=-30B; I_C=-100mA; P_D=200mBт; h_{21}=220...475; f_T>100MГц;$	B	E	C
3Ks	BC858BW	SIEM	PNP	$V_{CB0}=-30B; I_C=-100mA; P_D=250mBт; h_{21}=220...475; f_T=250MГц;$	B	E	C
3L	BC858CW	PHIL	PNP	$V_{CB0}=-30B; I_C=-100mA; P_D=200mBт; h_{21}=420...800; f_T>100MГц;$	B	E	C
3Ls	BC858CW	SIEM	PNP	$V_{CB0}=-30B; I_C=-100mA; P_D=250mBт; h_{21}=420...800; f_T=250MГц;$	B	E	C
3M	BC858W	PHIL	PNP	$V_{CB0}=-30B; I_C=-100mA; P_D=200mBт; h_{21}=125...800; f_T>100MГц;$	B	E	C
42	BAT54AW	PHIL	2xSHD	$V_R<30B; I_F<200mA; V_F(I_F=1mA)<320mB; C_D<10пФ; t_{RR}<5нс$	K1	K2	A2 A1
43	BAT54CW	PHIL	2xSHD	$V_R<30B; I_F<200mA; V_F(I_F=1mA)<320mB; C_D<10пФ; t_{RR}<5нс$	A1	A2	K1 K2
43	DTC143XUA	ROHM	D-NPN	$V_{CB0}=50B; I_C=100mA; P_D=200mBт; h_{21}>30; f_T>250MГц; R1/R2=4.7/10kOm$	B	E	C
44	BAT54SW	PHIL	2xSHD	$V_R<30B; I_F<200mA; V_F(I_F=1mA)<320mB; C_D<10пФ; t_{RR}<5нс$	A1	K2	K1 A2
44s	BAS40-04W	SIEM	2xSHD	$V_R<40B; I_F<120mA; V_F(I_F=15mA)<1.0B; I_R<1.0мкA; C_D<5.0пФ;$	A1	K2	K1 A2
45	DTC124XUA	ROHM	D-NPN	$V_{CB0}=50B; I_C=100mA; P_D=200mBт; h_{21}>68; f_T>250MГц; R1/R2=22/47kOm$	B	E	C
45s	BAS40-05W	SIEM	2xSHD	$V_R<40B; I_F<120mA; V_F(I_F=15mA)<1.0B; I_R<1.0мкA; C_D<5.0пФ;$	A1	K2	K1 A2
46s	BAS40-06W	SIEM	2xSHD	$V_R<40B; I_F<120mA; V_F(I_F=15mA)<1.0B; I_R<1.0мкA; C_D<5.0пФ;$	K1	K2	A1 A2
4A	BC859AW	PHIL	PNP	$V_{CB0}=-30B; I_C=-100mA; P_D=200mBт; h_{21}=125...250; f_T>100MГц;$	B	E	C
4As	BC859AW	SIEM	PNP	$V_{CB0}=-30B; I_C=-100mA; P_D=250mBт; h_{21}=125...250; f_T=250MГц;$	B	E	C
4B	BC859BW	PHIL	PNP	$V_{CB0}=-30B; I_C=-100mA; P_D=200mBт; h_{21}=220...475; f_T>100MГц;$	B	E	C

SOT323 (продолжение)

Код	Типономинал	Фирма	Функция	Особенности	Цоколевка		
					1	2	3
4Bs	BC859BW	SIEM	PNP	$V_{CB0}=-30B; I_C=-100mA; P_D=250mBT; h_{21}=125...475; f_T=250MГц;$	B	E	C
4C	BC859CW	PHIL	PNP	$V_{CB0}=-30B; I_C=-100mA; P_D=200mBT; h_{21}=420...800; f_T>100MГц;$	B	E	C
4Cs	BC859CW	SIEM	PNP	$V_{CB0}=-30B; I_C=-100mA; P_D=250mBT; h_{21}=420...800; f_T=250MГц;$	B	E	C
4D	BC859W	PHIL	PNP	$V_{CB0}=-30B; I_C=-100mA; P_D=200mBT; h_{21}=125...800; f_T>100MГц;$	B	E	C
4E	BC860AW	PHIL	PNP	$V_{CB0}=-50B; I_C=-100mA; P_D=200mBT; h_{21}=125...250; f_T>100MГц;$	B	E	C
4F	BC860BW	PHIL	PNP	$V_{CB0}=-50B; I_C=-100mA; P_D=200mBT; h_{21}=220...475; f_T>100MГц;$	B	E	C
4Fs	BC860BW	SIEM	PNP	$V_{CB0}=-50B; I_C=-100mA; P_D=250mBT; h_{21}=220...475; f_T=250MГц;$	B	E	C
4G	BC860CW	PHIL	PNP	$V_{CB0}=-50B; I_C=-100mA; P_D=200mBT; h_{21}=420...800; f_T>100MГц;$	B	E	C
4Gs	BC860CW	SIEM	PNP	$V_{CB0}=-50B; I_C=-100mA; P_D=250mBT; h_{21}=420...800; f_T=250MГц;$	B	E	C
4H	BC860W	PHIL	PNP	$V_{CB0}=-50B; I_C=-100mA; P_D=250mBT; h_{21}=125...800; f_T>100MГц;$	B	E	C
52	DTA123YUA	ROHM	D-PNP	$V_{CB0}=-50B; I_C=-500mA; P_D=200mBT; h_{21}>56; f_T>250MГц; R1/R2=2.2/10kOM$	B	E	C
53	BAT17W	SIEM	SHD	$V_R<4B; I_F<130mA; V_F(I_F=10mA)<0.6B; I_R<0.25mA; C_D<0.75пФ;$	A	nc	K
54	BAT17-04W	SIEM	2xSHD	$V_R<4B; I_F<130mA; V_F(I_F=10mA)<0.6B; I_R<0.25mA; C_D<0.75пФ;$	A1	K2	K1 A2
54	DTA114YUA	ROHM	D-PNP	$V_{CB0}=-50B; I_C=-100mA; P_D=200mBT; h_{21}>68; f_T>250MГц; R1/R2=10/47kOM$	B	E	C
55	BAT17-05W	SIEM	2xSHD	$V_R<4B; I_F<130mA; V_F(I_F=10mA)<0.6B; I_R<0.25mA; C_D<0.75пФ;$	A1	A2	K1 K2
56	BAT17-06W	SIEM	2xSHD	$V_R<4B; I_F<130mA; V_F(I_F=10mA)<0.6B; I_R<0.25mA; C_D<0.75пФ;$	K1	K2	A1 A2
5A	BC807-16W	PHIL	PNP	$V_{CB0}=-50B; I_C=-500mA; P_D=200mBT; h_{21}=100...250; f_T>80MГц;$	B	E	C
5As	BC807-16W	SIEM	PNP	$V_{CB0}=-50B; I_C=-500mA; P_D=250mBT; h_{21}=100...250; f_T=250MГц;$	B	E	C
5B	BC807-25W	PHIL	PNP	$V_{CB0}=-50B; I_C=-500mA; P_D=200mBT; h_{21}=160...400; f_T>80MГц;$	B	E	C
5Bs	BC807-25W	SIEM	PNP	$V_{CB0}=-50B; I_C=-500mA; P_D=250mBT; h_{21}=160...400; f_T=200MГц;$	B	E	C
5C	BC807-40W	PHIL	PNP	$V_{CB0}=-50B; I_C=-500mA; P_D=200mBT; h_{21}=250...600; f_T>80MГц;$	B	E	C
5Cs	BC807-40W	SIEM	PNP	$V_{CB0}=-50B; I_C=-500mA; P_D=250mBT; h_{21}=250...630; f_T=200MГц;$	B	E	C
5D	BC807W	PHIL	PNP	$V_{CB0}=-50B; I_C=-500mA; P_D=200mBT; h_{21}=100...600; f_T>80MГц;$	B	E	C
5E	BC808-16W	PHIL	PNP	$V_{CB0}=-25B; I_C=-500mA; P_D=200mBT; h_{21}=100...250; f_T>80MГц;$	B	E	C
5Es	BC808-16W	SIEM	PNP	$V_{CB0}=-30B; I_C=-500mA; P_D=250mBT; h_{21}=100...250; f_T=200MГц;$	B	E	C
5F	BC808-25W	PHIL	PNP	$V_{CB0}=-25B; I_C=-500mA; P_D=200mBT; h_{21}=160...400; f_T>80MГц;$	B	E	C
5Fs	BC808-25W	SIEM	PNP	$V_{CB0}=-30B; I_C=-500mA; P_D=250mBT; h_{21}=160...400; f_T=200MГц;$	B	E	C
5G	BC808-40W	PHIL	PNP	$V_{CB0}=-25B; I_C=-500mA; P_D=200mBT; h_{21}=250...600; f_T>80MГц;$	B	E	C
5Gs	BC808-40W	SIEM	PNP	$V_{CB0}=-30B; I_C=-500mA; P_D=250mBT; h_{21}=250...600; f_T=200MГц;$	B	E	C
5H	BC808W	PHIL	PNP	$V_{CB0}=-25B; I_C=-500mA; P_D=200mBT; h_{21}=100...600; f_T>80MГц;$	B	E	C
6.8	DF3A6.8FU	TOSH	2xPZ	$V_Z(I_{ZT}=5mA)=6.4...7.2B; I_R(V_R=5.0B)<0.5mA;$	K1	K2	A1 A2
62	DTC123YUA	ROHM	D-NPN	$V_{CB0}=-50B; I_C=-500mA; P_D=200mBT; h_{21}>33; f_T>250MГц; R1/R2=2.2/10kOM$	B	E	C
63	BAS40W	PHIL	SHD	$V_R<40B; I_F<120mA; V_F(I_F=1mA)<380B; C_D<5пФ;$	A	nc	K
64	BAS40-04W	PHIL	2xSHD	$V_R<40B; I_F<120mA; V_F(I_F=1mA)<380B; C_D<5пФ;$	A1	K2	K1 A2
64	DTC114YUA	ROHM	D-NPN	$V_{CB0}=50B; I_C=100mA; P_D=200mBT; h_{21}>68; f_T>250MГц; R1/R2=10/47kOM$	B	E	C
65	BAS40-05W	PHIL	2xSHD	$V_R<40B; I_F<120mA; V_F(I_F=1mA)<380B; C_D<5пФ;$	A1	A2	K1 K2

SOT323 (продолжение)

Код	Типономинал	Фирма	Функция	Особенности	Цоколевка		
					1	2	3
66	BAS40-06W	PHIL	2xSHD	$V_R < 40B$; $I_F < 120mA$; $V_F(I_F = 1mA) < 380B$; $C_D < 5пФ$;	K1	K2	A1 A2
6A	BC817-16W	PHIL	NPN	$V_{CB0} = 50B$; $I_C = 500mA$; $P_D = 200mBт$; $h_{21} = 100...250$; $f_T > 100MГц$;	B	E	C
6A	MUN5111T1	MOT	D-PNP	$V_{CB0} = -50B$; $I_C = -50mA$; $P_D = 150mBт$; $h_{21} > 35$	B	E	C
6As	BC817-16W	SIEM	NPN	$V_{CB0} = 50B$; $I_C = 500mA$; $P_D = 250mBт$; $h_{21} = 100...250$; $f_T > 170MГц$;	B	E	C
6B	BC817-25W	PHIL	NPN	$V_{CB0} = 50B$; $I_C = 500mA$; $P_D = 200mBт$; $h_{21} = 160...400$; $f_T > 100MГц$;	B	E	C
6B	MUN5112T1	MOT	D-PNP	$V_{CB0} = -50B$; $I_C = -50mA$; $P_D = 150mBт$; $h_{21} > 60$	B	E	C
6Bs	BC817-25W	SIEM	NPN	$V_{CB0} = 50B$; $I_C = 500mA$; $P_D = 250mBт$; $h_{21} = 160...400$; $f_T = 170MГц$;	B	E	C
6C	BC817-40W	PHIL	NPN	$V_{CB0} = 45B$; $I_C = 500mA$; $P_D = 200mBт$; $h_{21} = 250...600$; $f_T > 100MГц$;	B	E	C
6C	MUN5113T1	MOT	D-PNP	$V_{CB0} = -50B$; $I_C = -50mA$; $P_D = 150mBт$; $h_{21} > 80$	B	E	C
6Cs	BC817-40W	SIEM	NPN	$V_{CB0} = 50B$; $I_C = 500mA$; $P_D = 250mBт$; $h_{21} = 250...630$; $f_T = 170MГц$;	B	E	C
6D	BC817W	PHIL	NPN	$V_{CB0} = 50B$; $I_C = 500mA$; $P_D = 200mBт$; $h_{21} = 100...600$; $f_T > 100MГц$;	B	E	C
6D	MUN5114T1	MOT	D-PNP	$V_{CB0} = -50B$; $I_C = -50mA$; $P_D = 150mBт$; $h_{21} > 80$	B	E	C
6E	BC818-16W	PHIL	NPN	$V_{CB0} = 30B$; $I_C = 500mA$; $P_D = 200mBт$; $h_{21} = 100...250$; $f_T > 100MГц$;	B	E	C
6E	MUN5115T1	MOT	D-PNP	$V_{CB0} = -50B$; $I_C = -50mA$; $P_D = 150mBт$; $h_{21} > 160$	B	E	C
6Es	BC818-16W	SIEM	NPN	$V_{CB0} = 30B$; $I_C = 500mA$; $P_D = 250mBт$; $h_{21} = 100...250$; $f_T = 170MГц$;	B	E	C
6F	BC818-25W	PHIL	NPN	$V_{CB0} = 30B$; $I_C = 500mA$; $P_D = 200mBт$; $h_{21} = 160...400$; $f_T > 100MГц$;	B	E	C
6F	MUN5116T1	MOT	D-PNP	$V_{CB0} = -50B$; $I_C = -50mA$; $P_D = 150mBт$; $h_{21} > 160$	B	E	C
6G	BC818-40W	PHIL	NPN	$V_{CB0} = 30B$; $I_C = 500mA$; $P_D = 200mBт$; $h_{21} = 250...600$; $f_T > 100MГц$;	B	E	C
6G	MUN5130T1	MOT	D-PNP	$V_{CB0} = -50B$; $I_C = -50mA$; $P_D = 150mBт$; $h_{21} > 3$	B	E	C
6Gs	BC818-40W	SIEM	NPN	$V_{CB0} = 30B$; $I_C = 500mA$; $P_D = 250mBт$; $h_{21} = 250...630$; $f_T = 170MГц$;	B	E	C
6H	BC817W	PHIL	NPN	$V_{CB0} = 30B$; $I_C = 500mA$; $P_D = 200mBт$; $h_{21} = 100...600$; $f_T > 100MГц$;	B	E	C
6H	MUN5131T1	MOT	D-PNP	$V_{CB0} = -50B$; $I_C = -50mA$; $P_D = 150mBт$; $h_{21} > 8$	B	E	C
6J	MUN5132T1	MOT	D-PNP	$V_{CB0} = -50B$; $I_C = -50mA$; $P_D = 150mBт$; $h_{21} > 15$	B	E	C
6K	MUN5133T1	MOT	D-PNP	$V_{CB0} = -50B$; $I_C = -50mA$; $P_D = 150mBт$; $h_{21} > 80$	B	E	C
6L	MUN5134T1	MOT	D-PNP	$V_{CB0} = -50B$; $I_C = -50mA$; $P_D = 150mBт$; $h_{21} > 80$	B	E	C
6t3	1PS70SB40	PHIL	SHD	$V_R < 40B$; $I_F < 120mA$; $V_F(I_F = 1mA) < 380B$; $C_D < 5пФ$;	A	nc	K
6t4	1PS70SB44	PHIL	2xSHD	$V_R < 40B$; $I_F < 120mA$; $V_F(I_F = 1mA) < 380B$; $C_D < 10пФ$;	A1	K2	K1 A2
6t5	1PS70SB45	PHIL	2xSHD	$V_R < 40B$; $I_F < 120mA$; $V_F(I_F = 1mA) < 380B$; $C_D < 10пФ$;	A1	A2	K1 K2
6t6	1PS70SB46	PHIL	2xSHD	$V_R < 40B$; $I_F < 120mA$; $V_F(I_F = 1mA) < 380B$; $C_D < 10пФ$;	K1	K2	A1 A2
73p	BAS70W	PHIL	SHD	$V_R < 70B$; $I_F < 70mA$; $V_F(I_F = 1mA) < 410B$; $C_D < 2пФ$;	A	nc	C
74p	BAS70-04W	PHIL	2xSHD	$V_R < 70B$; $I_F < 70mA$; $V_F(I_F = 1mA) < 410B$; $C_D < 2пФ$;	A1	K2	K1 A2
74	DTA114WUA	ROHM	D-PNP	$V_{CB0} = -50B$; $I_C = -100mA$; $P_D = 200mBт$; $h_{21} > 24$; $f_T > 250MГц$; $R1/R2 = 10/4.7kOM$	B	E	C
74s	BAS70-04W	SIEM	2xSHD	$V_R < 70B$; $I_F < 70mA$; $V_F(I_F = 15mA) < 1.0B$; $I_R < 0.1мкA$; $C_D < 2.0пФ$;	A1	K2	K1 A2
75p	BAS70-05W	PHIL	2xSHD	$V_R < 70B$; $I_F < 70mA$; $V_F(I_F = 1mA) < 410mB$; $C_D < 2пФ$; $t_{RR} < 0.1нс$	A1	A2	K1 K2
75s	BAS70-05W	SIEM	2xSHD	$V_R < 70B$; $I_F < 70mA$; $V_F(I_F = 15mA) < 1.0mB$; $I_R < 0.1мкA$; $C_D < 2.0пФ$;	A1	A2	K1 K2
76p	BAS70-06W	PHIL	2xSHD	$V_R < 70B$; $I_F < 70mA$; $V_F(I_F = 1mA) < 410mB$; $C_D < 2пФ$; $t_{RR} < 0.1нс$	K1	K2	A2 A1
76	DTA144WUA	ROHM	D-PNP	$V_{CB0} = -50B$; $I_C(max) = 100mA$; $P_D = 200mBт$; $h_{21} > 56$; $f_T > 250MГц$; $R1/R2 = 47/22kOM$	B	E	C
76s	BAS70-06W	SIEM	2xSHD	$V_R < 70B$; $I_F < 70mA$; $V_F(I_F = 15mA) < 1.0mB$; $I_R < 0.1мкA$; $C_D < 2.0пФ$;	K1	K2	A1 A2
8.2	01BZA8.2	TOSH	2xPZ	$V_Z(I_{ZT} = 5mA) = 7.7...8.7B$; $I_R(V_R = 6.5B) < 0.5мкA$;	K1	K2	A1 A2
84	DTC114WUA	ROHM	D-NPN	$V_{CB0} = 50B$; $I_C = 100mA$; $P_D = 200mBт$; $h_{21} > 24$; $f_T > 250MГц$; $R1/R2 = 10/4.7kOM$	B	E	C
86	DTA144WUA	ROHM	D-NPN	$V_{CB0} = -50B$; $I_C(max) = 100mA$; $P_D = 200mBт$; $h_{21} > 56$; $f_T > 250MГц$; $R1/R2 = 47/22kOM$	B	E	C
93	DTA143TUA	ROHM	D-PNP	$V_{CB0} = -50B$; $I_C = -100mA$; $P_D = 200mBт$; $h_{21} = 100...600$; $f_T > 250MГц$; $R1 = 4.7kOM$	B	E	C

SOT323 (продолжение)

Код	Типономинал	Фирма	Функция	Особенности	Цоколевка		
					1	2	3
94	DTA114TUA	ROHM	D-PNP	$V_{CB0}=-50B; I_C=-100mA; P_D=200mBT; h_{21}=100...600; f_T>250MHz; R_1=10kOM$	B	E	C
95	DTA124TUA	ROHM	D-PNP	$V_{CB0}=-50B; I_C=-100mA; P_D=200mBT; h_{21}=100...600; f_T>250MHz; R_1=22kOM$	B	E	C
96	DTA144TUA	ROHM	D-PNP	$V_{CB0}=-50B; I_C=-100mA; P_D=200mBT; h_{21}=100...600; f_T>250MHz; R_1=47kOM$	B	E	C
99	DTA115TUA	ROHM	D-PNP	$V_{CB0}=-50B; I_C=-100mA; P_D=200mBT; h_{21}=100...600; f_T>250MHz; R_1=100kOM$	B	E	C
9A	DTA125TU	ROHM	D-PNP	$V_{CB0}=-50B; I_C=-100mA; P_D=200mBT; h_{21}=100...600; f_T>250MHz; R_1=200kOM$	B	E	C
A	MRF947T1	MOT	NPN	$V_{CB0}=20B; I_C=50mA; P_D=188mBT; h_{21}>50; f_T=8GHz$	B	E	C
A1	BAS70-06W	PHIL	2xFD	$V_R<75B; I_F<150mA; V_F(I_F=50mA)<1.0mB; C_D<2пФ; t_{RR}<4нс$	K1	K2	A2 A1
A1s	BAW56W	PHIL	2xDI	$V_R<70B; I_F<200mA; V_F(I_F=150mA)<1.25mB; C_D<2.0пФ; t_{RR}<6нс$	K1	K2	A1 A2
A3	1PS300	PHIL	2xFD	$V_R<80B; I_F<200mA; V_F(I_F=50mA)<1.0mB; C_D<2.0пФ; t_{RR}<4нс$	K1	K2	A1 A2
A3	1SS300	TOSH	2xDI	$V_R<80B; I_F<100mA; V_F(I_F=100mA)<1.2mB; t_{RR}<4нс$	K1	K2	A1 A2
A3	KDS120	KEC	2xDI	$V_R<80B; I_F=100mA; I_R=0.5mA; C_T=2.2пФ$	K1	K2	A1 A2
A4	BAV70W	PHIL	2xFD	$V_R<70B; I_F<175mA; V_F(I_F=50mA)<1.0mB; C_D<1.5пФ; t_{RR}<4нс$	A1	A2	K1 K2
A4s	BAV70W	SIEM	2xDI	$V_R<70B; I_F<200mA; V_F(I_F=150mA)<1.25mB; C_D<1.5пФ; t_{RR}<6нс$	A1	A2	K1 K2
A6	BAS16W	PHIL	FD	$V_R<75B; I_F<175mA; V_F(I_F=50mA)<1.0mB; C_D<1.5пФ; t_{RR}<4нс$	A	nc	K
A6s	BAS16W	SIEM	DI	$V_R<75B; I_F<250mA; V_F(I_F=50mA)<1.0mB; C_D<2.0пФ; t_{RR}<6нс$	A	nc	K
A7	BAV99W	PHIL	2xFD	$V_R<75B; I_F<150mA; V_F(I_F=50mA)<1.0mB; C_D<1.5пФ; t_{RR}<4нс$	A1	A2	K1 K2
A7s	BAV99W	SIEM	2xDI	$V_R<70B; I_F<200A; V_F(I_F=150mA)<1.25mB; C_D<1.5пФ; t_{RR}<6нс$	A1	A2	K1 K2
A9	1SS322	TOSH	SHD	$V_R<40B; I_F<100A; V_F(I_F=100mA)<0.6B; C_D=18пФ$	A	nc	K
AN	2SC4098N	ROHM	NPN	$V_{CB0}=40B; I_C=50mA; P_D=200mBT; h_{21}=56...120; f_T=300MHz$	B	E	C
AP	2SC4098P	ROHM	NPN	$V_{CB0}=40B; I_C=50mA; P_D=200mBT; h_{21}=82...180; f_T=300MHz$	B	E	C
AQ	2SC4098Q	ROHM	NPN	$V_{CB0}=40B; I_C=50mA; P_D=200mBT; h_{21}=120...270; f_T=300MHz$	B	E	C
B3	1PS301	PHIL	2xFD	$V_R<80B; I_F<250A; V_F(I_F=50mA)<1.0B; C_D<1.5пФ; t_{RR}<4нс$	A1	A2	K1 K2
B3	1SS301	TOSH	2xDI	$V_R<80B; I_F<100A; V_F(I_F=100mA)<1.2B; t_{RR}<4нс$	A1	A2	K1 K2
B9	1PS301	TOSH	DI	$V_R<400B; I_F<100A; V_F(I_F=100mA)<1.3B$	A	nc	K
BDM	2SA1808M	ROHM	PNP	$V_{CB0}=-30B; I_C=-30mA; P_D=200mBT; h_{21}=39...82; f_T>400MHz$	B	E	C
BDN	2SA1808N	ROHM	PNP	$V_{CB0}=-30B; I_C=-30mA; P_D=200mBT; h_{21}=56...120; f_T>400MHz$	B	E	C
BDP	2SA1808P	ROHM	PNP	$V_{CB0}=-30B; I_C=-30mA; P_D=200mBT; h_{21}=82...180; f_T>400MHz$	B	E	C
BF	KDS112	KEC	2xDI	$V_R=30B; I_F=50mA; I_R=0.1mA; C_T=0.8пФ$	A1	A2	K1 K2
BFR	2SC4723R	ROHM	NPN	$V_{CB0}=50B; I_C=100mA; P_D=200mBT; h_{21}=180...390; f_T>180MHz$	B	E	C
BFS	2SC4723S	ROHM	NPN	$V_{CB0}=50B; I_C=100mA; P_D=200mBT; h_{21}=270...560; f_T>180MHz$	B	E	C
BHM	2SC4700M	ROHM	NPN	$V_{CB0}=25B; I_C=200mA; P_D=150mBT; h_{21}=39...82; f_T>250MHz$	B	E	C
BHN	2SC4700N	ROHM	NPN	$V_{CB0}=25B; I_C=200mA; P_D=150mBT; h_{21}=56...120; f_T>250MHz$	B	E	C
BHP	2SC4700P	ROHM	NPN	$V_{CB0}=25B; I_C=200mA; P_D=150mBT; h_{21}=82...180; f_T>250MHz$	B	E	C
BJU	2SD2351U	ROHM	NPN	$V_{CB0}=60B; I_C=150mA; P_D=200mBT; h_{21}=560...1200; f_T>250MHz$	B	E	C
BJV	2SD2351V	ROHM	NPN	$V_{CB0}=60B; I_C=150mA; P_D=200mBT; h_{21}=820...1800; f_T>250MHz$	B	E	C
BJW	2SD2351W	ROHM	NPN	$V_{CB0}=60B; I_C=150mA; P_D=200mBT; h_{21}=1200...2700; f_T>250MHz$	B	E	C
BLL	2SC4772L	ROHM	NPN	$V_{CB0}=30B; I_C=50mA; P_D=150mBT; h_{21}=27...56; f_T>600MHz$	B	E	C

SOT323 (продолжение)

Код	Типономинал	Фирма	Функция	Особенности	Цоколевка		
					1	2	3
BLM	2SC4772M	ROHM	NPN	$V_{CB0}=30B; I_C=50_{MA}; P_D=150_{MBT}; h_{21}=39...82;$ $f_T>600_{MГц}$	B	E	C
BLN	2SC4772N	ROHM	NPN	$V_{CB0}=30B; I_C=50_{MA}; P_D=150_{MBT}; h_{21}=56...120;$ $f_T>600_{MГц}$	B	E	C
BLP	2SC4772P	ROHM	NPN	$V_{CB0}=30B; I_C=50_{MA}; P_D=150_{MBT}; h_{21}=82...180;$ $f_T>600_{MГц}$	B	E	C
BMQ	2SC4774Q	ROHM	NPN	$V_{CB0}=12B; I_C=50_{MA}; P_D=150_{MBT}; h_{21}=120...270;$ $f_T=800_{MГц}$	B	E	C
BMR	2SC4774R	ROHM	NPN	$=V_{CB0}=12B; I_C=50_{MA}; P_D=150_{MBT}; h_{21}=180...390;$ $f_T=800_{MГц}$	B	E	C
BMS	2SC4774S	ROHM	NPN	$V_{CB0}=12B; I_C=50_{MA}; P_D=150_{MBT}; h_{21}=270...560;$ $f_T=800_{MГц}$	B	E	C
BQ	2SC4081Q	ROHM	NPN	$V_{CB0}=50B; I_C=150_{MA}; P_D=200_{MBT}; h_{21}=120...270;$ $f_T>180_{MГц}$	B	E	C
BR	2SC4081R	ROHM	NPN	$V_{CB0}=50B; I_C=150_{MA}; P_D=200_{MBT}; h_{21}=180...390;$ $f_T>180_{MГц}$	B	E	C
BR	MSB1218A-RT1	MOT	PNP	$V_{CB0}=-45B; I_C=-100_{MA}; P_D=150_{MBT}; h_{21}=210...340$	B	E	C
BS	2SC4081S	ROHM	NPN	$V_{CB0}=50B; I_C=150_{MA}; P_D=200_{MBT}; h_{21}=270...560;$ $f_T>180_{MГц}$	B	E	C
BS	MSB1218A-ST1	MOT	PNP	$V_{CB0}=-45B; I_C=-100_{MA}; P_D=150_{MBT}; h_{21}=290...460$	B	E	C
C3	1PS302	PHIL	2xFD	$V_R<80B; I_F<200A; V_F(I_F=50_{MA})<1.0B; C_D<1.5_{пФ};$ $t_{RR}<4_{нс}$	A1	K2	K1 A2
C3	1SS302	TOSH	2xDI	$V_R<80B; I_F<100A; V_F(I_F=100_{MA})<1.2B; t_{RR}<4_{нс}$	A1	K2	K1 A2
CG	2SA1587G	TOSH	PNP	$V_{CB0}=-120B; I_C=-100_{MA}; P_D=100_{MBT}; h_{21}>200...400;$ $f_T>=100_{MГц}$	B	E	C
CHA	2SC4667A	TOSH	NPN	$V_{CB0}=60B; I_C=150_{MA}; P_D=200_{MBT}; h_{21}=560...1200;$ $f_T>250_{MГц}$	B	E	C
CHB	2SC4667B	TOSH	NPN	$V_{CB0}=15B; I_C=200_{MA}; P_D=100_{MBT}; h_{21}=1200...3600;$ $f_T>250_{MГц}$	B	E	C
CL	2SA1587B	TOSH	PNP	$V_{CB0}=-120B; I_C=150_{MA}; P_D=200_{MBT}; h_{21}=560...1200;$ $f_T>250_{MГц}$	B	E	C
CP	2SC4097P	ROHM	NPN	$V_{CB0}=40B; I_C=500_{MA}; P_D=200_{MBT}; h_{21}=82...180;$ $f_T>250_{MГц}$	B	E	C
CQ	2PB1219Q	PHIL	PNP	$V_{CB0}=-30B; I_C=-500_{MA}; P_D=200_{MBT}; h_{21}=85...170;$ $f_T>100_{MГц}$	B	E	C
CQ	2SC4097Q	ROHM	NPN	$V_{CB0}=40B; I_C=500_{MA}; P_D=200_{MBT}; h_{21}=120...270;$ $f_T>250_{MГц}$	B	E	C
CR	2PB1219R	PHIL	PNP	$V_{CB0}=-30B; I_C=-500_{MA}; P_D=200_{MBT}; h_{21}=120...240;$ $f_T>120_{MГц}$	B	E	C
CR	2SC4097R	ROHM	NPN	$V_{CB0}=40B; I_C=500_{MA}; P_D=200_{MBT}; h_{21}=180...390;$ $f_T>250_{MГц}$	B	E	C
CS	2PB1219S	PHIL	PNP	$V_{CB0}=-30B; I_C=-500_{MA}; P_D=200_{MBT}; h_{21}=170...340;$ $f_T>140_{MГц}$	B	E	C
DQ	2PB1219AQ	PHIL	PNP	$V_{CB0}=-60B; I_C=-500_{MA}; P_D=200_{MBT}; h_{21}=85...170;$ $f_T>100_{MГц}$	B	E	C
DR	2PB1219AR	PHIL	PNP	$V_{CB0}=-60B; I_C=-500_{MA}; P_D=200_{MBT}; h_{21}=120...240;$ $f_T>120_{MГц}$	B	E	C
DS	2PB1219AS	PHIL	PNP	$V_{CB0}=-60B; I_C=-500_{MA}; P_D=200_{MBT}; h_{21}=170...340;$ $f_T>140_{MГц}$	B	E	C
E0	HSMP-381B	HP	PIN	$I_F<1A; V_{BR}>100B; R_T<3.0_{OM}; C_T<0.35_{пФ};$ $R_H>1500_{OM};$ $R_L<100_{OM}$	A	nc	K
E2	HSMP-381C	HP	2xPIN	$I_F<1A; V_{BR}>100B; R_T<3.0_{OM}; C_T<0.35_{пФ};$ $R_H>1500_{OM};$ $R_L<100_{OM}$	A1	K2	A2 K1
E3	2SA1688	SANYO	PNP	$V_{CB0}=-30B; I_C=-30_{MA}; P_D=150_{MBT}; h_{21}=60...120;$ $f_T>320_{MГц}$	B	E	C
E3	HSMP-381E	HP	2xPIN	$I_F<1A; V_{BR}>100B; R_T<3.0_{OM}; C_T<0.35_{пФ};$ $R_H>1500_{OM};$ $R_L<100_{OM}$	K1	K2	A1 A2
E4	2SA1688	SANYO	PNP	$V_{CB0}=-30B; I_C=-30_{MA}; P_D=150_{MBT}; h_{21}=90...180;$ $f_T>320_{MГц}$	B	E	C
E4	HSMP-381F	HP	2xPIN	$I_F<1A; V_{BR}>100B; R_T<3.0_{OM}; C_T<0.35_{пФ};$ $R_H>1500_{OM};$ $R_L<100_{OM}$	K1	K2	A1 A2
E5	2SA1688	SANYO	PNP	$V_{CB0}=-30B; I_C=-30_{MA}; P_D=150_{MBT}; h_{21}=135...270;$ $f_T>320_{MГц}$	B	E	C
EC	2SC4462	HIT	NPN	$V_{CB0}=30B; I_C=20_{MA}; P_D=150_{MBT}; h_{21}>30; f_T>700_{MГц}$	B	E	C
F3	2SC4399	SANYO	NPN	$V_{CB0}=30B; I_C=30_{MA}; P_D=150_{MBT}; h_{21}=60...120;$ $f_T>320_{MГц}$	B	E	C
F4	2SC4399	SANYO	NPN	$V_{CB0}=30B; I_C=30_{MA}; P_D=150_{MBT}; h_{21}=90...180;$ $f_T>320_{MГц}$	B	E	C

SOT323 (продолжение)

Код	Типономинал	Фирма	Функция	Особенности	Цоколевка		
					1	2	3
F5	1SS370	TOSH	DI	$V_R < 200B; I_F < 100A; V_F(I_F = 100mA) < 1.2B; t_{RR} < 60нс$	A	nc	K
F5	2SC4399	SANYO	NPN	$V_{CB0} = 30B; I_C = 30mA; P_D = 150mBT; h_{21} = 135...270; f_T > 320MГц$	B	E	C
-F8	BF824W	PHIL	PNP	$V_{CB0} = -30B; I_C = -25mA; P_D = 200mBT; h_{21} > 25; f_T > 400MГц$	B	E	C
FQ	2PA1576Q	PHIL	PNP	$V_{CB0} = -50B; I_C = -100mA; P_D = 200mBT; h_{21} = 120...270; f_T = 100MГц$	B	E	C
FQ	2SA1576AQ	ROHM	PNP	$V_{CB0} = -50B; I_C = -150mA; P_D = 200mBT; h_{21} = 120...270; f_T > 140MГц$	B	E	C
FR	2PA1576R	PHIL	PNP	$V_{CB0} = -50B; I_C = -100mA; P_D = 200mBT; h_{21} = 180...390; f_T > 100MГц$	B	E	C
FR	2SA1576AR	ROHM	PNP	$V_{CB0} = -50B; I_C = -150mA; P_D = 200mBT; h_{21} = 180...390; f_T > 140MГц$	B	E	C
FS	2PA1576S	PHIL	PNP	$V_{CB0} = -50B; I_C = -100mA; P_D = 200mBT; h_{21} = 270...560; f_T > 100MГц$	B	E	C
FS	2SA1576AS	ROHM	PNP	$V_{CB0} = -50B; I_C = -150mA; P_D = 200mBT; h_{21} = 270...560; f_T > 140MГц$	B	E	C
G	MRF947AT1	MOT	NPN	$V_{CB0} = 20B; I_C = 50mA; P_D = 180mBT; h_{21} = 75...150; f_T = 8ГГц$	B	E	C
G0	HSMP-389B	HP	PIN	$I_F < 1A; V_{BR} > 100B; R_S < 2.5OM; C_T < 0.30пФ$	A	nc	K
-G1	PMST5551	PHIL	NPN	$V_{CB0} = 180B; I_C = 600mA; P_D = 200mBT; h_{21} = 80...250; f_T = 100...300 MГц$	B	E	C
G2	HSMP-389C	HP	2xPIN	$I_F < 1A; V_{BR} > 100B; R_S < 2.5OM; C_T < 0.30пФ$	A1	K2	K1 A2
G3	HSMP-389E	HP	2xPIN	$I_F < 1A; V_{BR} > 100B; R_S < 2.5OM; C_T < 0.30пФ$	K1	K2	A1 A2
G4	HSMP-389F	HP	2xPIN	$I_F < 1A; V_{BR} > 100B; R_S < 2.5OM; C_T < 0.30пФ$	A1	A2	K1 K2
GC	2SC4264	HIT	NPN	$V_{CB0} = 20B; I_C = 50mA; P_D = 100mBT; h_{21} = 20...200; f_T > 1.4ГГц$	B	E	C
H	MRF947BT1	MOT	NPN	$V_{CB0} = 20B; I_C = 50mA; P_D = 188mBT; h_{21} = 100...200; f_T = 8ГГц$	B	E	C
H	MRF947BT3	MOT	NPN	$V_{CB0} = 20B; I_C = 50mA; P_D = 188mBT; h_{21} = 100...200; f_T = 8ГГц$	B	E	C
HC	2SC4463	HIT	NPN	$V_{CB0} = 30B; I_C = 50mA; P_D = 100mBT; h_{21} > 60; f_T > 600MГц$	B	E	C
HE	2SC4102E	ROHM	NPN	$V_{CB0} = 120B; I_C = 50mA; P_D = 200mBT; h_{21} = 390...820; f_T > 140MГц$	B	E	C
HP	2SA1577P	ROHM	PNP	$V_{CB0} = -40B; I_C = -500mA; P_D = 200mBT; h_{21} = 82...180; f_T > 200MГц$	B	E	C
HQ	2SA1577Q	ROHM	PNP	$V_{CB0} = -40B; I_C = -500mA; P_D = 200mBT; h_{21} = 120...270; f_T > 200MГц$	B	E	C
HR	2SA1577R	ROHM	PNP	$V_{CB0} = -40B; I_C = -500mA; P_D = 200mBT; h_{21} = 180...390; f_T > 200MГц$	B	E	C
HR	2SC4102R	ROHM	NPN	$V_{CB0} = 120B; I_C = 50mA; P_D = 200mBT; h_{21} = 180...390; f_T > 140MГц$	B	E	C
HS	2SC4102S	ROHM	NPN	$V_{CB0} = 120B; I_C = 50mA; P_D = 200mBT; h_{21} = 270...560; f_T > 140MГц$	B	E	C
I	MRF947RT3	MOT	NPN	$V_{CB0} = 20B; I_C = 50mA; P_D = 188mBT; h_{21} > 50; f_T = 8000MГц$	E	B	C
IL-	2SC4263	HIT	NPN	$V_{CB0} = 15B; I_C = 20mA; P_D = 100mBT; h_{21} = 30...200; f_T > 700MГц$	B	E	C
IP-	2SC4262	HIT	NPN	$V_{CB0} = 20B; I_C = 50mA; P_D = 100mBT; h_{21} = 50...200; f_T > 1.4ГГц$	B	E	C
IS-	2SC4537	HIT	NPN	$V_{CB0} = 15B; I_C = 50mA; P_D = 100mBT; h_{21} = 50...250; f_T > 4.5ГГц$	B	E	C
JC	2SC4265	HIT	NPN	$V_{CB0} = 30B; I_C = 50mA; P_D = 100mBT; h_{21} > 40; f_T > 600MГц$	B	E	C
JC	BAL74W	PHIL	FD	$V_R < 75B; I_F < 175A; V_F(I_F = 50mA) < 1.0B; C_D < 1.5пФ; t_{RR} < 4нс$	nc	A	K
JF	BAL99W	PHIL	FD	$V_R < 70B; I_F < 150A; V_F(I_F = 50mA) < 1.0B; C_D < 1.5пФ; t_{RR} < 4нс$	nc	A	K
JM	2SC4099M	ROHM	NPN	$V_{CB0} = 25B; I_C = 20mA; P_D = 150mBT; h_{21} = 39...82; f_T > 500MГц$	B	E	C
JN	2SC4099N	ROHM	NPN	$V_{CB0} = 25B; I_C = 20mA; P_D = 150mBT; h_{21} = 56...120; f_T > 500MГц$	B	E	C
JP	2SC4099P	ROHM	NPN	$V_{CB0} = 25B; I_C = 20mA; P_D = 150mBT; h_{21} = 82...180; f_T > 500MГц$	B	E	C
JS3	2SA1857	SANYO	PNP	$V_{CB0} = -15B; I_C = -50mA; P_D = 150mBT; h_{21} = 60...120; f_T > 750MГц$	B	E	C
JS4	2SA1857	SANYO	PNP	$V_{CB0} = -15B; I_C = -50mA; P_D = 150mBT; h_{21} = 90...180; f_T > 750MГц$	B	E	C
JS5	2SA1857	SANYO	PNP	$V_{CB0} = -15B; I_C = -50mA; P_D = 150mBT; h_{21} = 135...270; f_T > 750MГц$	B	E	C
K14	DTA114GUA	ROHM	D-PNP	$V_{CB0} = -50B; I_C = -100mA; P_D = 200mBT; h_{21} > 30; f_T > 250MГц; R_2 = 10кOM$	B	E	C
K15	DTA124GUA	ROHM	D-PNP	$V_{CB0} = -50B; I_C = -100mA; P_D = 200mBT; h_{21} > 56; f_T > 250MГц; R_2 = 22кOM$	B	E	C
K16	DTA144GUA	ROHM	D-PNP	$V_{CB0} = -50B; I_C = -100mA; P_D = 200mBT; h_{21} > 68; f_T > 250MГц; R_2 = 47кOM$	B	E	C
K19	DTA115GUA	ROHM	D-PNP	$V_{CB0} = -50B; I_C = -100mA; P_D = 200mBT; h_{21} > 82; f_T > 250MГц; R_2 = 100кOM$	B	E	C
K24	DTC114GUA	ROHM	D-NPN	$V_{CB0} = 50B; I_C = 100mA; P_D = 200mBT; h_{21} > 30; f_T > 250MГц; R_2 = 10кOM$	B	E	C
K25	DTC124GUA	ROHM	D-NPN	$V_{CB0} = 50B; I_C = 100mA; P_D = 200mBT; h_{21} > 56; f_T > 250MГц; R_2 = 22кOM$	B	E	C
K26	DTC144GUA	ROHM	D-NPN	$V_{CB0} = 50B; I_C = 100mA; P_D = 200mBT; h_{21} > 68; f_T > 250MГц; R_2 = 47кOM$	B	E	C
K29	DTC115GUA	ROHM	D-NPN	$V_{CB0} = 50B; I_C = 100mA; P_D = 200mBT; h_{21} > 82; f_T > 250MГц; R_2 = 100кOM$	B	E	C

SOT323 (продолжение)

Код	Типономинал	Фирма	Функция	Особенности	Цоколевка		
					1	2	3
K3B	DTA1D3RUA	ROHM	PNP	$V_{CB0}=-50B; I_{C(max)}=-100mA; P_D=100mBT; h_{21}>20; f_T>250MГц$	B	E	C
K4B	DTC1D3RUA	ROHM	NPN	$V_{CB0}=50B; I_{C(max)}=-100mA; P_D=100mBT; h_{21}>20; f_T>250MГц$	B	E	C
KH	2SK1827	TOSH	nFET	$V_{DS}>50B; I_D=50mA; R_{DS(on)}<500\Omega; g_F>20mC_M P_D=100mBT;$	G	S	D
KI	2SK1829	TOSH	nMOS	$V_{DS}>20B; I_D=50mA; R_{DS(on)}<400\Omega; g_F>20mC_M P_D=100mBT;$	G	S	D
KK	2SK2824	TOSH	nMOS	$V_{DS}>20B; I_D=100mA; R_{DS(on)}<280\Omega; g_F>35mC_M P_D=100mBT;$	G	S	D
KP	2SK2034	TOSH	nMOS	$V_{DS}>20B; I_D=100mA; R_{DS(on)}<120\Omega; g_F>25mC_M P_D=100mBT;$	G	S	D
KJ	2SK2037	TOSH	nMOS	$V_{DS}>20B; I_D=100mA; R_{DS(on)}<60\Omega; g_F>35mC_M P_D=100mBT;$	G	S	D
KQ	2SJ344	TOSH	pMOS	$V_{DS}>50B; I_D=50mA; R_{DS(on)}<500\Omega; g_F>15mC_M P_D=100mBT;$	G	S	D
KS	2SJ346	TOSH	pMOS	$V_{DS}>20B; I_D=50mA; R_{DS(on)}<400\Omega; g_F>15mC_M P_D=100mBT;$	G	S	D
L0	HSMP-386B	HP	PIN	$I_F<1A; V_{BR}>50B; R_S(typ)=3.0\Omega; C_T(typ)=0.20пФ$	A	nc	K
L2	HSMP-386C	HP	2xPIN	$I_F<1A; V_{BR}>50B; R_S(typ)=3.0\Omega; C_T(typ)=0.20пФ$	A1	K2	K1 A2
L2	KTC4075	KEC	NPN	$V_{CB0}=60B; I_C=150mA; P_D=100mBT; h_{21}=70...140; f_T>80MГц$	B	E	C
L3	HSMP-386E	HP	2xPIN	$I_F<1A; V_{BR}>50B; R_S(typ)=3.0\Omega; C_T(typ)=0.20пФ$	K1	K2	A1 A2
L4	BAT54W	PHIL	SHD	$V_R<30B; I_F<200mA; V_F(I_F=1mA)<320mB; C_D<10пФ; t_{RR}<5нс$	A	nc	K
L4	HSMP-386F	HP	2xPIN	$I_F<1A; V_{BR}>50B; R_S(typ)=3.0\Omega; C_T(typ)=0.20пФ$	A1	A2	K1 K2
L4	KTC4075	KEC	NPN	$V_{CB0}=60B; I_C=150mA; P_D=100mBT; h_{21}=120...240; f_T>80MГц$	B	E	C
L6	KTC4075	KEC	NPN	$V_{CB0}=60B; I_C=150mA; P_D=100mBT; h_{21}=200...400; f_T>80MГц$	B	E	C
L8	KTC4075	KEC	NPN	$V_{CB0}=60B; I_C=150mA; P_D=100mBT; h_{21}=350...700; f_T>80MГц$	B	E	C
LBL	KTC4075	KEC	NPN	$V_{CB0}=60B; I_C=150mA; P_D=100mBT; h_{21}=350...700; f_T>80MГц$	B	E	C
LEs	BF660W	SIEM	PNP	$V_{CB0}=-40B; I_C=-25mA; P_D=280mBT; h_{21}>30; f_T=700MГц$	B	E	C
LG	2SC4116	TOSH	NPN	$V_{CB0}=60B; I_C=150mA; P_D=100mBT; h_{21}>200...400; f_T>80MГц$	B	E	C
LGR	KTC4075	KEC	NPN	$V_{CB0}=60B; I_C=150mA; P_D=100mBT; h_{21}=200...400; f_T>80MГц$	B	E	C
LHs	BF569W	SIEM	PNP	$V_{CB0}=-40B; I_C=-30mA; P_D=280mBT; h_{21}>20; f_T=950MГц$	B	E	C
LKs	BF799W	SIEM	NPN	$V_{CB0}=30B; I_C=35mA; P_D=280mBT; h_{21}=40...250; f_T=1100MГц$	B	E	C
LL	2SC4116	TOSH	NPN	$V_{CB0}=60B; I_C=150mA; P_D=100mBT; h_{21}>350...700; f_T>80MГц$	B	E	C
LO	2SC4116	TOSH	NPN	$V_{CB0}=60B; I_C=150mA; P_D=100mBT; h_{21}>70...140; f_T>80MГц$	B	E	C
LO*	KTC4075	KEC	NPN	$V_{CB0}=60B; I_C=150mA; P_D=100mBT; h_{21}>70...140; f_T>80MГц$	B	E	C
LOs	BF775W	SIEM	NPN	$V_{CB0}=20B; I_C=30mA; P_D=280mBT; h_{21}>40...200; f_T=5000MГц$	B	E	C
LY	2SC4116	TOSH	NPN	$V_{CB0}=60B; I_C=150mA; P_D=100mBT; h_{21}>120...240; f_T>80MГц$	B	E	C
LY	KTC4075	KEC	NPN	$V_{CB0}=60B; I_C=150mA; P_D=100mBT; h_{21}>120...240; f_T>80MГц$	B	E	C
MCs	BFS17W	SIEM	NPN	$V_{CB0}=25B; I_C=50mA; P_D=280mBT; h_{21}>20...150; f_T>2500MГц$	B	E	C
N9	1SS372	TOSH	2xSHD	$V_R<10B; I_F<100mA; V_F(I_F=100mA)<0.5B; C_D<40пФ;$	A1	K2	K1 A2
NA	KRC401	KEC	NPN	$V_{CB0}=50B; I_C=100mA; P_D=100mBT; R_1/R_2=4.7/4.7k\Omega$	B	E	C
NB	KRC402	KEC	NPN	$V_{CB0}=50B; I_C=100mA; P_D=100mBT; R_1/R_2=10/10k\Omega$	B	E	C
NC	KRC403	KEC	NPN	$V_{CB0}=50B; I_C=100mA; P_D=100mBT; R_1/R_2=22/22k\Omega$	B	E	C
ND	KRC404	KEC	NPN	$V_{CB0}=50B; I_C=100mA; P_D=100mBT; R_1/R_2=47/47k\Omega$	B	E	C
NE	KRC405	KEC	NPN	$V_{CB0}=50B; I_C=100mA; P_D=100mBT; R_1/R_2=2.2/47k\Omega$	B	E	C
NF	KRC406	KEC	NPN	$V_{CB0}=50B; I_C=100mA; P_D=100mBT; R_1/R_2=4.7/47k\Omega$	B	E	C
NK	KRC410	KEC	NPN	$V_{CB0}=50B; I_C=100mA; P_D=100mBT; R_1=4.7k\Omega$	B	E	C
NM	KRC411	KEC	NPN	$V_{CB0}=50B; I_C=100mA; P_D=100mBT; R_1=10k\Omega$	B	E	C
NN	KRC412	KEC	NPN	$V_{CB0}=50B; I_C=100mA; P_D=100mBT; R_1=100k\Omega$	B	E	C
NO	KRC413	KEC	NPN	$V_{CB0}=50B; I_C=100mA; P_D=100mBT; R_1=22k\Omega$	B	E	C
NP	KRC414	KEC	NPN	$V_{CB0}=50B; I_C=100mA; P_D=100mBT; R_1=47k\Omega$	B	E	C
O9	1SS378	TOSH	2xSHD	$V_R<10B; I_F<100mA; V_F(I_F=100mA)<0.5B; C_D<20пФ;$	A1	A2	K1 K2
P1A	PMST3904	PHIL	NPN	$V_{CB0}=60B; I_C=200mA; P_D=200mBT; h_{21}=100...300; f_T>300MГц$	B	E	C
P1Q	PMST5088	PHIL	NPN	$V_{CB0}=35B; I_C=50mA; P_D=200mBT; h_{21}>300...900$	B	E	C
P1R	PMST5089	PHIL	NPN	$V_{CB0}=30B; I_C=50mA; P_D=200mBT; h_{21}>400...1200$	B	E	C
P1s	BFR92W	SIEM	NPN	$V_{CB0}=20B; I_C=30mA; P_D=280mBT; h_{21}=40...200; f_T=5000MГц$	B	E	C
P2A	PMST3906	PHIL	PNP	$V_{CB0}=-40B; I_C=-200mA; P_D=200mBT; h_{21}=100...300; f_T>250MГц$	B	E	C
P2T	PMST4403	PHIL	PNP	$V_{CB0}=-40B; I_C=-600mA; P_D=200mBT; h_{21}=100...300; f_T>200MГц$	B	E	C
P2X	PMST4401	PHIL	NPN	$V_{CB0}=60B; I_C=600mA; P_D=200mBT; h_{21}=100...300; f_T>250MГц$	B	E	C
PA	2SC4666	TOSH	NPN	$V_{CB0}=50B; I_C=150mA; P_D=100mBT; h_{21}>600...1800; f_T=250MГц$	B	E	C
PB	2SC4666	TOSH	NPN	$V_{CB0}=50B; I_C=150mA; P_D=100mBT; h_{21}>1200...3600; f_T=250MГц$	B	E	C
PH	KRA307	KEC	PNP	$V_{CB0}=-50B; I_C=-100mA; P_D=100mBT; R_1/R_2=10/47k\Omega$	B	E	C
PI	KRA308	KEC	PNP	$V_{CB0}=-50B; I_C=-100mA; P_D=100mBT; R_1/R_2=22/47k\Omega$	B	E	C
PJ	KRA309	KEC	PNP	$V_{CB0}=-50B; I_C=-100mA; P_D=100mBT; R_1/R_2=47/22k\Omega$	B	E	C
P04	PMSS3904	PHIL	NPN	$V_{CB0}=60B; I_C=200mA; P_D=200mBT; h_{21}=100...300; f_T>180MГц$	B	E	C
P06	PMSS3906	PHIL	PNP	$V_{CB0}=-40B; I_C=-200mA; P_D=200mBT; h_{21}=100...300; f_T>150MГц$	B	E	C

SOT323 (продолжение)

Код	Типоминал	Фирма	Функция	Особенности	Цоколевка		
					1	2	3
QI-	2SC4261	HIT	NPN	$V_{CB0}=25B; I_C=50_{MA}; P_D=100_{mBT}; h_{21}=50...180; f_T>1.8_{ГГц}$	B	E	C
Q0	KTC4080	KEC	NPN	$V_{CB0}=40B; I_C=20_{MA}; P_D=100_{mBT}; h_{21}=70...140; f_T>550_{МГц}$	B	E	C
QR	KTC4080	KEC	NPN	$V_{CB0}=40B; I_C=20_{MA}; P_D=100_{mBT}; h_{21}=40...80; f_T>550_{МГц}$	B	E	C
QY	KTC4080	KEC	NPN	$V_{CB0}=40B; I_C=20_{MA}; P_D=100_{mBT}; h_{21}=100...200; f_T>550_{МГц}$	B	E	C
R2s	BFR93AW	SIEM	NPN	$V_{CB0}=15B; I_C=50_{MA}; P_D=300_{mBT}; h_{21}=50...200; f_T=6000_{МГц}$	B	E	C
R9	1SS393	TOSH	2xSHD	$V_R<40B; I_F<100_{MA}; V_F(I_F=100_{MA})<0.6B; C_D=18_{пФ}$	A1	A2	K1 K2
RBs	BF771W	SIEM	NPN	$V_{CB0}=20B; I_C=80_{MA}; P_D=400_{mBT}; h_{21}=50...200; f_T=8000_{МГц}$	B	E	C
RCs	BFR193W	SIEM	NPN	$V_{CB0}=20B; I_C=80_{MA}; P_D=580_{mBT}; h_{21}=50...200; f_T=8000_{МГц}$	B	E	C
RDs	BFR180W	SIEM	NPN	$V_{CB0}=10B; I_C=4_{MA}; P_D=30_{mBT}; h_{21}=30...200; f_T=7000_{МГц}$	B	E	C
RE	2SA1579E	ROHM	PNP	$V_{CB0}=-120B; I_C=-50_{MA}; P_D=200_{mBT}; h_{21}=390...820; f_T>140_{МГц}$	B	E	C
Res	BFR280W	SIEM	NPN	$V_{CB0}=10B; I_C=10_{MA}; P_D=80_{mBT}; h_{21}=30...200; f_T=7500_{МГц}$	B	E	C
RFs	BFR181W	SIEM	NPN	$V_{CB0}=20B; I_C=20_{MA}; P_D=175_{mBT}; h_{21}=50...200; f_T=8000_{МГц}$	B	E	C
RGs	BFR182W	SIEM	NPN	$V_{CB0}=20B; I_C=35_{MA}; P_D=250_{mBT}; h_{21}=50...200; f_T=8000_{МГц}$	B	E	C
RHs	BFR183W	SIEM	NPN	$V_{CB0}=20B; I_C=65_{MA}; P_D=450_{mBT}; h_{21}=50...200; f_T=8000_{МГц}$	B	E	C
RR	2SA1579R	ROHM	PNP	$V_{CB0}=-120B; I_C=-50_{MA}; P_D=200_{mBT}; h_{21}=180...390; f_T>140_{МГц}$	B	E	C
RS	2SA1579S	ROHM	PNP	$V_{CB0}=-120B; I_C=-50_{MA}; P_D=200_{mBT}; h_{21}=270...560; f_T>140_{МГц}$	B	E	C
RT3	2SC4400	SANYO	NPN	$V_{CB0}=40B; I_C=50_{MA}; P_D=150_{mBT}; h_{21}=60...120; f_T>750_{МГц}$	B	E	C
RT4	2SC4400	SANYO	NPN	$V_{CB0}=40B; I_C=50_{MA}; P_D=150_{mBT}; h_{21}=90...180; f_T>750_{МГц}$	B	E	C
RT5	2SC4400	SANYO	NPN	$V_{CB0}=40B; I_C=50_{MA}; P_D=150_{mBT}; h_{21}=135...270; f_T>750_{МГц}$	B	E	C
S2	KTA2014	KEC	PNP	$V_{CB0}=-50B; I_C=-150_{MA}; P_D=100_{mBT}; h_{21}=70...140; f_T>80_{МГц}$	B	E	C
S4	KTA2014	KEC	PNP	$V_{CB0}=-50B; I_C=-150_{MA}; P_D=100_{mBT}; h_{21}=120...240; f_T>80_{МГц}$	B	E	C
S6	KTA2014	KEC	PNP	$V_{CB0}=-50B; I_C=-150_{MA}; P_D=100_{mBT}; h_{21}=200...400; f_T>80_{МГц}$	B	E	C
S9	1SS395	TOSH	SHD	$V_R<10B; I_F<100_{MA}; V_F(I_F=100_{MA})<0.5B; C_D<40_{пФ}$	A	nc	K
SG	2SA1586	TOSH	PNP	$V_{CB0}=-50B; I_C=-150_{MA}; P_D=100_{mBT}; h_{21}=200...400; f_T>80_{МГц}$	B	E	C
SGR	KTA2014	KEC	PNP	$V_{CB0}=-50B; I_C=-150_{MA}; P_D=100_{mBT}; h_{21}=200...400; f_T>80_{МГц}$	B	E	C
SM	2SC4100M	ROHM	NPN	$V_{CB0}=30B; I_C=50_{MA}; P_D=200_{mBT}; h_{21}=39...82; f_T>110_{МГц}$	B	E	C
SN	2SC4100N	ROHM	NPN	$V_{CB0}=30B; I_C=50_{MA}; P_D=200_{mBT}; h_{21}=56...120; f_T>110_{МГц}$	B	E	C
SO	2SA1586	TOSH	PNP	$V_{CB0}=-50B; I_C=-150_{MA}; P_D=100_{mBT}; h_{21}>70...140; f_T>80_{МГц}$	B	E	C
SO	KTA2014	KEC	PNP	$V_{CB0}=-50B; I_C=-150_{MA}; P_D=100_{mBT}; h_{21}=70...140; f_T>80_{МГц}$	B	E	C
SP	2SC4100P	ROHM	NPN	$V_{CB0}=30B; I_C=50_{MA}; P_D=200_{mBT}; h_{21}=82...180; f_T>110_{МГц}$	B	E	C
SQ	2SC4100Q	ROHM	NPN	$V_{CB0}=30B; I_C=50_{MA}; P_D=200_{mBT}; h_{21}=120...270; f_T>110_{МГц}$	B	E	C
SY	2SA1586	TOSH	PNP	$V_{CB0}=-50B; I_C=-150_{MA}; P_D=100_{mBT}; h_{21}=120...240; f_T>80_{МГц}$	B	E	C
SY	KTA2014	KEC	PNP	$V_{CB0}=-50B; I_C=-150_{MA}; P_D=100_{mBT}; h_{21}=70...140; f_T>80_{МГц}$	B	E	C
TE	2SC4102E	ROHM	NPN	$V_{CB0}=120B; I_C=50_{MA}; P_D=200_{mBT}; h_{21}=390...820; f_T>140_{МГц}$	B	E	C
TI-	2SC4260	HIT	NPN	$V_{CB0}=25B; I_C=50_{MA}; P_D=100_{mBT}; h_{21}=50...180; f_T>3_{ГГц}$	B	E	C
TR	2SC4102R	ROHM	NPN	$V_{CB0}=120B; I_C=50_{MA}; P_D=200_{mBT}; h_{21}=180...390; f_T>140_{МГц}$	B	E	C
TS	2SC4102S	ROHM	NPN	$V_{CB0}=120B; I_C=50_{MA}; P_D=200_{mBT}; h_{21}=270...560; f_T>140_{МГц}$	B	E	C
UI-	2SC4259	HIT	NPN	$V_{CB0}=30B; I_C=20_{MA}; P_D=100_{mBT}; h_{21}=50...180; f_T>700_{МГц}$	B	E	C
W1s	BFT92W	SIEM	PNP	$V_{CB0}=-20B; I_C=-25_{MA}; P_D=200_{mBT}; h_{21}>15; f_T>5000_{МГц}$	B	E	C
WCs	BCR133W	SIEM	D-NPN	$V_{CB0}=50B; I_C=100_{MA}; P_D=250_{mBT}; h_{21}>30; f_T=130_{МГц}$	B	E	C
WDs	BCR141W	SIEM	D-NPN	$V_{CB0}=50B; I_C=100_{MA}; P_D=250_{mBT}; h_{21}>50; f_T=130_{МГц}$	B	E	C
Wes	BCR148W	SIEM	D-NPN	$V_{CB0}=50B; I_C=70_{MA}; P_D=250_{mBT}; h_{21}>70; f_T=100_{МГц}$	B	E	C
WFs	BCR112W	SIEM	D-NPN	$V_{CB0}=50B; I_C=100_{MA}; P_D=250_{mBT}; h_{21}>20; f_T>140_{МГц}$	B	E	C
WGs	BCR116W	SIEM	D-NPN	$V_{CB0}=50B; I_C=100_{MA}; P_D=250_{mBT}; h_{21}>70; f_T=160_{МГц}$	B	E	C
WHs	BCR108W	SIEM	D-NPN	$V_{CB0}=50B; I_C=100_{MA}; P_D=250_{mBT}; h_{21}>70; f_T=170_{МГц}$	B	E	C
Wis	BCR158W	SIEM	D-NPN	$V_{CB0}=-50B; I_C=-100_{MA}; P_D=250_{mBT}; h_{21}>70; f_T=200_{МГц}$	B	E	C
WJs	BCR135W	SIEM	D-NPN	$V_{CB0}=50B; I_C=100_{MA}; P_D=250_{mBT}; h_{21}>70; f_T=150_{МГц}$	B	E	C
WKs	BCR119W	SIEM	D-NPN	$V_{CB0}=50B; I_C=100_{MA}; P_D=200_{mBT}; h_{21}=120...630; f_T>150_{МГц}$	B	E	C
WLS	BCR146W	SIEM	D-NPN	$V_{CB0}=50B; I_C=70_{MA}; P_D=250_{mBT}; h_{21}>50; f_T=150_{МГц}$	B	E	C
WMs	BCR183W	SIEM	D-PNP	$V_{CB0}=-50B; I_C=-100_{MA}; P_D=250_{mBT}; h_{21}>30; f_T>200_{МГц}$	B	E	C
WNs	BCR185W	SIEM	D-PNP	$V_{CB0}=-50B; I_C=-100_{MA}; P_D=250_{mBT}; h_{21}>70; f_T=200_{МГц}$	B	E	C
Wos	BCR191W	SIEM	D-PNP	$V_{CB0}=-50B; I_C=-100_{MA}; P_D=250_{mBT}; h_{21}>50; f_T>200_{МГц}$	B	E	C
WPs	BCR192W	SIEM	D-PNP	$V_{CB0}=-50B; I_C=-100_{MA}; P_D=250_{mBT}; h_{21}>70; f_T>200_{МГц}$	B	E	C
WRs	BCR198W	SIEM	D-PNP	$V_{CB0}=-50B; I_C=-70_{MA}; P_D=250_{mBT}; h_{21}>70; f_T=190_{МГц}$	B	E	C
WSs	BCR169W	SIEM	D-PNP	$V_{CB0}=-50B; I_C=-100_{MA}; P_D=250_{mBT}; h_{21}=120...630; f_T>150_{МГц}$	B	E	C
WTs	BCR166W	SIEM	D-PNP	$V_{CB0}=-50B; I_C=-100_{MA}; P_D=250_{mBT}; h_{21}>70; f_T=160_{МГц}$	B	E	C
Wus	BCR162W	SIEM	D-PNP	$V_{CB0}=-50B; I_C=-100_{MA}; P_D=250_{mBT}; h_{21}>20; f_T>200_{МГц}$	B	E	C
WXs	BCR196W	SIEM	D-PNP	$V_{CB0}=-50B; I_C=-70_{MA}; P_D=250_{mBT}; h_{21}>50; f_T=150_{МГц}$	B	E	C
WZs	BCR142W	SIEM	D-NPN	$V_{CB0}=50B; I_C=100_{MA}; P_D=250_{mBT}; h_{21}>70; f_T=150_{МГц}$	B	E	C
XF-	2SC4464	HIT	NPN	$V_{CB0}=15B; I_C=5_{MA}; P_D=50_{mBT}; h_{21}=40...250; f_T>2.5_{ГГц}$	B	E	C
XM-	2SC4593	HIT	NPN	$V_{CB0}=15B; I_C=50_{MA}; P_D=100_{mBT}; h_{21}=40...250; f_T>6.5_{ГГц}$	B	E	C
XT-	2SC4674	HIT	NPN	$V_{CB0}=12B; I_C=8_{MA}; P_D=50_{mBT}; h_{21}=50...250; f_T>4_{ГГц}$	B	E	C

SOT323 (продолжение)

Код	Типономинал	Фирма	Функция	Особенности	Цоколевка		
					1	2	3
YP	2SD1949P	ROHM	NPN	$V_{CB0}=50B; I_C=500_{MA}; P_D=200_{mBT}; h_{21}=82...180;$ $f_T>250_{MГц}$	B	E	C
YQ	2SD1949Q	ROHM	NPN	$V_{CB0}=50B; I_C=500_{MA}; P_D=200_{mBT}; h_{21}=120...270;$ $f_T>250_{MГц}$	B	E	C
YR	2SD1949R	ROHM	NPN	$V_{CB0}=50B; I_C=500_{MA}; P_D=200_{mBT}; h_{21}=180...390;$ $f_T>250_{MГц}$	B	E	C
ZQ	2PC4081Q	PHIL	NPN	$V_{CB0}=50B; I_C=100_{MA}; P_D=200_{mBT}; h_{21}=120...270;$ $f_T>100_{MГц}$	B	E	C
ZR	2PC4081R	PHIL	NPN	$V_{CB0}=50B; I_C=100_{MA}; P_D=200_{mBT}; h_{21}=180...390;$ $f_T>100_{MГц}$	B	E	C
ZR	MSD1819A-RT1	MOT	NPN	$V_{CB0}=60B; I_C=100_{MA}; P_D=150_{mBT}; h_{21}=210...340$	B	E	C
ZS	2PC4081S	PHIL	NPN	$V_{CB0}=50B; I_C=100_{MA}; P_D=200_{mBT}; h_{21}=270...560;$ $f_T>100_{MГц}$	B	E	C

SOT-343

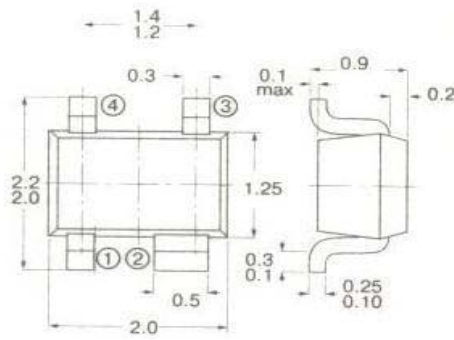

Код	Типоминал	Фирма	Функция	Особенности	Цоколевка			
					1	2	3	4
ALs	BFT405	SIEM	NPN	$V_{CB0}=15B; I_C=12mA; P_D=55mB; h_{21}=50...150; f_T>20ГГц$	B	E	C	E
AMs	BFT420	SIEM	NPN	$V_{CB0}=15B; I_C=35mA; P_D=160mB; h_{21}=50...150; f_T>20ГГц$	B	E	C	E
ANs	BFT450	SIEM	NPN	$V_{CB0}=15B; I_C=10mA; P_D=450mB; h_{21}=50...150; f_T>15ГГц$	B	E	C	E
DI-	2SC3867	HIT	NPN	$V_{CB0}=20B; I_C=50mA; P_D=150mB; h_{21}=20...200; f_T>1400МГц$	B	E	C	nc
EC	2SC2732	HIT	NPN	$V_{CB0}=30B; I_C=20mA; P_D=150mB; h_{21}>30; f_T>700МГц$	E	B	C	nc
EI-	3SK182	HIT	nMOS	$V_{DS}=20B; I_D=50mA; P_D=150mB; P_G>10дБ; NF<6.0дБ$	S	D	G2	G1
FI-	3SK186	HIT	nMOS	$V_{DS}=12B; I_D=35mA; P_D=150mB; P_G>16дБ; NF<4.5дБ$	S	D	G2	G1
GC	2SC2734	HIT	NPN	$V_{CB0}=20B; I_C=50mA; P_D=150mB; h_{21}=20...200; f_T>1.4ГГц$	E	B	C	nc
HC	2SC2733	HIT	NPN	$V_{CB0}=30B; I_C=50mA; P_D=150mB; h_{21}>60; f_T>600МГц$	E	B	C	nc
HI-	3SK188	HIT	nMOS	$V_{DS}=22B; I_D=35mA; P_D=150mB; P_G>18дБ; NF<3.2дБ$	S	D	G2	G1
ID-	2SC3127	HIT	NPN	$V_{CB0}=20B; I_C=50mA; P_D=150mB; P_G=10.5 дБ; f_T>3500МГц$	E	B	C	nc
IG-	2SK360	HIT	nMOS	$V_{DS}=20B; I_D=30mA; P_{CH}=150mB; P_G=30дБ; NF=2.0дБ$	E	B	C	nc
IJ-	2SC3374	HIT	NPN	$V_{CB0}=20B; I_C=20mA; P_D=150mB; h_{21}=20...200; f_T>400МГц$	E	B	C	nc
IL-	2SC3493	HIT	NPN	$V_{CB0}=15B; I_C=20mA; P_D=150mB; h_{21}=30...200; f_T>700МГц$	E	B	C	nc
IP-	2SC3793	HIT	NPN	$V_{CB0}=20B; I_C=50mA; P_D=150mB; h_{21}=50...200; f_T>1400МГц$	E	B	C	nc
IS-	2SC3513	HIT	NPN	$V_{CB0}=15B; I_C=50mA; P_D=150mB; h_{21}=50...250; f_T>4500МГц$	E	B	C	nc
IT-	3SK162	HIT	nMOS	$V_{DS}=12B; I_D=35mA; P_D=150mB; P_G>18дБ; NF<3.0дБ$	S	D	G2	G1
IV-	2SK668	HIT	nFET	$GaAs; V_{DS}=6.0B; I_D=100mA; P_{CH}=150mB; P_G=10дБ; NF=2.5дБ$	S	D	S	G
IV-	3SK136	HIT	nMOS	$V_{DS}=20B; I_D=35mA; P_D=150mB; P_G>17дБ; NF<3.3дБ$	S	D	G2	G1
IW-	3SK137	HIT	nMOS	$V_{DS}=15B; I_D=35mA; P_D=150mB; P_G>10дБ; NF<5.0дБ$	S	D	G2	G1
IW-	3SK137V	HIT	nMOS	$V_{DS}=15B; I_D=35mA; P_D=150mB; P_G>20дБ; NF<3.0дБ$	S	D	G2	G1
IX-	3SK138	HIT	nMOS	$V_{DS}=15B; I_D=35mA; P_D=150mB; P_G>10дБ; NF<5.0дБ$	S	D	G2	G1
IY-	3SK194	HIT	nMOS	$V_{DS}=15B; I_D=35mA; P_D=150mB; P_G>27дБ; NF<2.5дБ$	S	D	G2	G1
IZ-	3SK154	HIT	nMOS	$V_{DS}=15B; I_D=35mA; P_D=150mB; P_G>22дБ; NF<3.0дБ$	S	D	G2	G1
JC	2SC2735	HIT	NPN	$V_{CB0}=30B; I_C=50mA; P_D=150mB; h_{21}>40; f_T>600МГц$	E	B	C	nc
MI-	2SC4126	HIT	NPN	$V_{CB0}=15B; I_C=50mA; P_D=150mB; h_{21}=50...250; f_T>4500МГц$	E	B	C	nc
MOs	BF998W	SIEM	nMOS	$V_{DS}=12B; I_D=30mA; P_D=200mB; NF=1.0дБ; I_{DSS}=2...18mA; g_F=24mCm$	D	S	G1	G2
MYs	BF1012W	SIEM	nMOS	$V_{DS}=16B; I_D=40mA; P_D=200mB; NF=1.4дБ; g_F=26mCm$	D	S	G1	G2
NI-	3SK191	HIT	nFET	$GaAs; V_{DS}=12.0B; I_D=80mA; P_{CH}=150mB; P_G>12дБ; NF<3.0дБ$	S	D	G2	G1
NI-	3SK191	HIT	nFET	$GaAs; V_{DS}=12.0B; I_D=80mA; P_{CH}=150mB; P_G>12дБ; NF<3.0дБ$	S	D	G2	G1
PAAs	BFP136W	SIEM	NPN	$V_{CB0}=20B; I_C=150mA; P_D=1000mB; h_{21}=80...250; f_T>5900МГц$	E	C	E	B

SOT-343 (продолжение)

Код	Типоминал	Фирма	Функция	Особенности	Цоколевка			
					1	2	3	4
QI-	2SC196	HIT	NPN	$V_{CB0}=25B; I_C=50_{MA}; P_D=150_{MBT}; h_{21}=50...180;$ $f_T>1800_{MГц}$	E	B	C	nc
RCs	BFP193W	SIEM	NPN	$V_{CB0}=20B; I_C=80_{MA}; P_D=580_{MBT}; h_{21}=50...200;$ $f_T=8000_{MГц}$	E	C	E	B
RDs	BFP180W	SIEM	NPN	$V_{CB0}=10B; I_C=4_{MA}; P_D=30_{MBT}; h_{21}=30...200;$ $f_T>6200_{MГц}$	E	C	E	B
REs	BFP280W	SIEM	NPN	$V_{CB0}=10B; I_C=10_{MA}; P_D=80_{MBT}; h_{21}=30...200;$ $f_T>7000_{MГц}$	E	C	E	B
RFs	BFP181W	SIEM	NPN	$V_{CB0}=20B; I_C=20_{MA}; P_D=175_{MBT}; h_{21}=50...200;$ $f_T=8000_{MГц}$	E	C	E	B
RGs	BFP182W	SIEM	NPN	$V_{CB0}=20B; I_C=35_{MA}; P_D=250_{MBT}; h_{21}=50...200;$ $f_T>8300_{MГц}$	E	C	E	B
RHs	BFP183W	SIEM	NPN	$V_{CB0}=20B; I_C=65_{MA}; P_D=450_{MBT}; h_{21}=50...200;$ $f_T=8000_{MГц}$	E	C	E	B
RIs	BFP196W	SIEM	NPN	$V_{CB0}=20B; I_C=100_{MA}; P_D=700_{MBT}; h_{21}=50...200;$ $f_T>7200_{MГц}$	E	C	E	B
TC	2SC2736	HIT	NPN	$V_{CB0}=25B; I_C=50_{MA}; P_D=150_{MBT}; h_{21}=30...200;$ $f_T>1400_{MГц}$	E	B	C	nc
TI-	2SC4197	HIT	NPN	$V_{CB0}=25B; I_C=50_{MA}; P_D=150_{MBT}; h_{21}=50...180;$ $f_T>3000_{MГц}$	E	B	C	nc
VI-	2SC4229	HIT	NPN	$V_{CB0}=30B; I_C=20_{MA}; P_D=150_{MBT}; h_{21}=50...180;$ $f_T>700_{MГц}$	E	B	C	nc
WI-	3SK197	HIT	nMOS	$V_{DS}=12B; I_D=35_{MA}; P_D=150_{MBT}; P_G=24.6_{дБ}; NF<5.5_{дБ}$	S	D	G2	G1
XB-	2SC4416	HIT	NPN	$V_{CB0}=25B; I_C=50_{MA}; P_D=150_{MBT}; h_{21}=50...180;$ $f_T>3000_{MГц}$	B	E	C	nc
XC-	2SC4415	HIT	NPN	$V_{CB0}=30B; I_C=20_{MA}; P_D=150_{MBT}; h_{21}=50...180;$ $f_T>700_{MГц}$	C	B	E	B
XE-	2SK1092	HIT	nFET	$GaAs; V_{DS}=4B; I_D=150_{MA}; P_D=150_{MBT}; P_G>8_{дБ};$ $NF<3.5_{дБ}$	S	D	nc	G
XI-	3SK196	HIT	nMOS	$V_{DS}=12B; I_D=35_{MA}; P_D=150_{MBT}; P_G=32_{дБ}; NF=1.0_{дБ}$	S	D	G2	G1
XM-	2SC4591	HIT	NPN	$V_{CB0}=15B; I_C=50_{MA}; P_D=150_{MBT}; h_{21}=40...250;$ $f_T>6500_{MГц}$	E	B	C	nc
XN-	2SC4592	HIT	NPN	$V_{CB0}=15B; I_C=50_{MA}; P_D=150_{MBT}; h_{21}=40...250;$ $f_T>7000_{MГц}$	C	E	B	E
XR-	3SK228	HIT	nFET	$GaAs; V_{DS}=12.0B; I_D=50_{MA}; P_D=150_{MBT}; P_G>17_{дБ};$ $NF<2.0_{дБ}$	S	D	G2	G1
XS-	3SK229	HIT	nFET	$GaAs; V_{DS}=12.0B; I_D=50_{MA}; P_D=150_{MBT}; P_G>17_{дБ};$ $NF<2.0_{дБ}$	S	D	G2	G1
XV-	2SC4680	HIT	NPN	$V_{CB0}=12B; I_C=50_{MA}; P_D=150_{MBT}; h_{21}>100$	E	B	C	nc

**SOT-353
SC-88A**

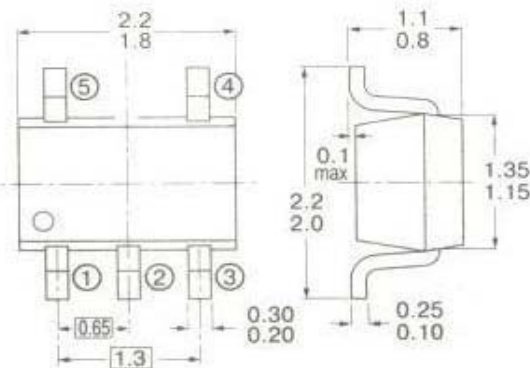
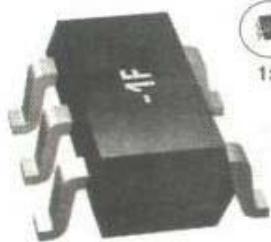

Код	Типономинал	Фирма	Функция	Особенности	Цоколевка				
					1	2	3	4	5
S1	UMS1	ROHM	2xPNP	$V_{CB0}=50B; I_C=100mA; P_D(ком)=300мВт; h_{21}>120$	B1	E1 E2	B2	C2	C1
S2	UMS2	ROHM	2xPNP	$V_{CB0}=50B; I_C=100mA; P_D(ком)=300мВт; h_{21}>120$	E1	B1 B2	E2	C2	C1
W1	UMW1N	ROHM	2xNPN	$V_{CB0}=50B; I_C=100mA; P_D(ком)=300мВт; h_{21}=180...560$	B1	E1 E2	B2	C2	C1
W10	UMW10N	ROHM	2xNPN	$V_{CB0}=30B; I_C=50mA; P_D(ком)=300мВт; h_{21}=27...270; f_T>1500MHz$	B1	E1 E2	B2	C2	C1
W11	UMW11N	ROHM	2xNPN	$V_{CB0}=30B; I_C=50mA; P_D(ком)=300мВт; h_{21}=27...270; f_T>1500MHz$	E1	B1 B2	E2	C2	C1
W12	UMW12N	ROHM	2xNPN	$V_{CB0}=50B; I_C=100mA; P_D(ком)=300мВт; h_{21}>120$	E1 C2	C1	B1	B2	E2
W13	UMW13N	ROHM	2xNPN	$V_{CB0}=30B; I_C=50mA; P_D(ком)=300мВт; h_{21}=27...270; f_T>2000MHz$	E1	B1 B2	E2	C2	C1
W2	UMW2N	ROHM	2xNPN	$V_{CB0}=50B; I_C=100mA; P_D(ком)=300мВт; h_{21}>120$	E1	B1 B2	E2	C2	C1
W5	UMW5N	ROHM	2xNPN	$V_{CB0}=50B; I_C=100mA; P_D(ком)=300мВт; h_{21}>250$	B1	E1 E2	B2	C2	C1
W6	UMW6N	ROHM	2xNPN	$V_{CB0}=30B; I_C=50mA; P_D(ком)=300мВт; h_{21}=27...270; f_T>1500MHz$	E2	B2	B1	C1	E1 C2
W7	UMW7N	ROHM	2xNPN	$V_{CB0}=20B; I_C=50mA; P_D(ком)=300мВт; h_{21}=27...270; f_T>3200MHz$	E2	B2	B1	C1	E1 C2
W8	UMW8N	ROHM	2xNPN	$V_{CB0}=20B; I_C=50mA; P_D(ком)=300мВт; h_{21}=27...270; f_T>3200MHz$	B1	E1 E2	B2	C2	C1
W9	UMW9T	ROHM	2xNPN	$V_{CB0}=20B; I_C=50mA; P_D(ком)=300мВт; h_{21}=27...270; f_T>3200MHz$	E1	B1 B2	E2	C2	C1
Y1	UMY1N	ROHM	PNP(1)+ NPN(2)	$V_{CB0}=50B; I_C=100mA; P_D(ком)=300мВт; h_{21}>120; f_T>180MHz$	B1	E1 E2	B2	C2	C1
Y3	UMY3N	ROHM	PNP(1)+ NPN(2)	$V_{CB0}=50B; I_C=50mA; P_D(ком)=300мВт; h_{21}=120...560; f_T>180MHz$	B1	E1 E2	B2	C2	C1
Y4	UMY4N	ROHM	PNP(1)+ NPN(2)	$V_{CB0}=50B; I_C=50mA; P_D(ком)=300мВт; h_{21}=120...560; f_T>180MHz$	E1	B1 B2	E2	C2	C1

SOT-363 SC-88

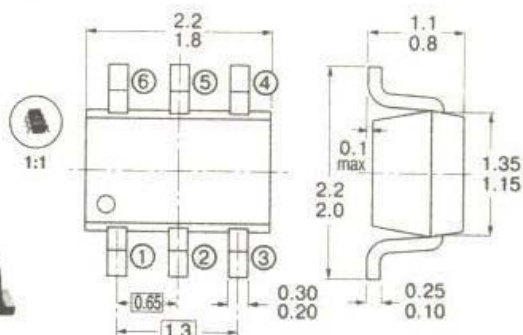

Код	Типономинал	Фирма	Функция	Особенности	Цоколевка					
					1	2	3	4	5	6
1Cs	BC847S	SIEM	2xNPN	$V_{CB0}=50B; I_C=100mA; P_D=250mBт; h_{21}=110...630; f_T=250MГц$	E1	B1	C2	E2	B2	C1
1Ps	BC847PN	SIEM	PNP(1)+NPN(2)	$V_{CB0}=50B; I_C=100mA; P_D=250mBт; h_{21}=110...630; f_T=250MГц$	E1	B1	C2	E2	B2	C1
3Cs	BC857S	SIEM	2xPNP	$V_{CB0}=50B; I_C=100mA; P_D=250mBт; h_{21}=125...630; f_T=250MГц$	E1	B1	C2	E2	B2	C1
MCs	BFS17S	SIEM	2xNPN	$V_{CB0}=25B; I_C=50mA; P_D=280mBт; h_{21}=20...150; f_T>2500MГц$	B1	E1	C2	B2	E2	C1
Res	BFS480	SIEM	2xNPN	$V_{CB0}=10B; I_C=10mA; P_D=80mBт; h_{21}=30...200; f_T=7500MГц$	B1	E1	C2	B2	E2	C1
RFs	BFS481	SIEM	2xNPN	$V_{CB0}=20B; I_C=20mA; P_D=150mBт; h_{21}=50...200; f_T=8000MГц$	B1	E1	C2	B2	E2	C1
RGs	BFS482	SIEM	2xNPN	$V_{CB0}=20B; I_C=35mA; P_D=250mBт; h_{21}=50...200; f_T=8000MГц$	B1	E1	C2	B2	E2	C1
RHs	BFS483	SIEM	2xNPN	$V_{CB0}=20B; I_C=65mA; P_D=450mBт; h_{21}=50...200; f_T=8000MГц$	B1	E1	C2	B2	E2	C1
T1	UMT1N	ROHM	2xPNP	$V_{CB0}=50B; I_C=100mA; P_D(com)=300mBт; h_{21}>120$	E1	B1	C2	E2	B2	C1
T2	UMT2N	ROHM	2xPNP	$V_{CB0}=50B; I_C=100mA; P_D(com)=300mBт; h_{21}>120$	E1	E2	B2	C2	B1	C1
T3	UMT3N	ROHM	2xPNP	$V_{CB0}=50B; I_C=100mA; P_D(com)=300mBт; h_{21}>120$	E1	B1	B2	C2	E2	C1
W1s	BCR10PN	SIEM	D-PNP(2)+D-NPN(1)	$V_{CB0}=50B; I_C=100mA; P_D=250mBт; h_{21}>30; f_T=130MГц$	E1	B1	C2	E2	B2	C1
WCs	BCR133S	SIEM	D-2xNPN	$V_{CB0}=50B; I_C=100mA; P_D=200mBт; h_{21}>30; f_T=130MГц$	E1	B1	C2	E2	B2	C1
WDs	BCR141S	SIEM	D-2xNPN	$V_{CB0}=50B; I_C=100mA; P_D=250mBт; h_{21}>50; f_T>130MГц$	E1	B1	C1	E2	B2	C2
Wes	BCR148S	SIEM	D-2xNPN	$V_{CB0}=50B; I_C=70mA; P_D=250mBт; h_{21}>70; f_T>100MГц$	E1	B1	C1	E2	B2	C2
WFs	BCR08PN	SIEM	D-PNP(2)+D-NPN(1)	$V_{CB0}=50B; I_C=100mA; P_D=250mBт; h_{21}>70; f_T=170MГц$	E1	B1	C2	E2	B2	C1
WHs	BCR108S	SIEM	D-2xNPN	$V_{CB0}=50B; I_C=100mA; P_D=200mBт; h_{21}>70; f_T>170MГц$	E1	B1	C1	E2	B2	C2
WJs	BCR135S	SIEM	D-2xNPN	$V_{CB0}=50B; I_C=100mA; P_D=250mBт; h_{21}>70; f_T>150MГц$	E1	B1	C1	E2	B2	C2
WKS	BCR119S	SIEM	D-2xNPN	$V_{CB0}=50B; I_C=100mA; P_D=250mBт; h_{21}=120...630; f_T>150MГц$	E1	B1	C1	E2	B2	C2
WMs	BCR183S	SIEM	D-2xPNP	$V_{CB0}=50B; I_C=100mA; P_D=250mBт; h_{21}>30; f_T=200MГц$	E1	B1	C2	E2	B2	C1
WNs	BCR185S	SIEM	D-2xPNP	$V_{CB0}=50B; I_C=100mA; P_D=250mBт; h_{21}>70; f_T>200MГц$	E1	B1	C1	E2	B2	C2
Wos	BCR191S	SIEM	D-2xPNP	$V_{CB0}=50B; I_C=100mA; P_D=250mBт; h_{21}>50; f_T>200MГц$	E1	B1	C1	E2	B2	C2
WPs	BCR22PN	SIEM	D-PNP(2)+D-NPN(1)	$V_{CB0}=50B; I_C=100mA; P_D=250mBт; h_{21}>50; f_T=130MГц$	E1	B1	C2	E2	B2	C1
WRs	BCR198S	SIEM	D-2xPNP	$V_{CB0}=50B; I_C=70mA; P_D=250mBт; h_{21}>70; f_T>190MГц$	E1	B1	C1	E2	B2	C2
WSs	BCR169S	SIEM	D-2xPNP	$V_{CB0}=50B; I_C=100mA; P_D=250mBт; h_{21}=120...630; f_T>150MГц$	E1	B1	C1	E2	B2	C2
WTs	BCR48PN	SIEM	D-PNP(1)+D-NPN(2)	$V_{CB0}=50B; I_C=(70NPN 100PNP)mA; P_D=250mBт; h_{21}>70; f_T>100MГц$	E1	B1	C1	E2	B2	C2
WVs	BCR35PN	SIEM	D-PNP(1)+D-NPN(2)	$V_{CB0}=50B; I_C=100mA; P_D=250mBт; h_{21}>70; f_T>150MГц$	E1	B1	C1	E2	B2	C2

SOT-363 (продолжение)

Код	Типономинал	Фирма	Функция	Особенности	Цоколевка					
					1	2	3	4	5	6
WVs	BCR129S	SIEM	D-2xNPN	$V_{CB0}=50B; I_C=100mA; P_D=250mBT;$ $h_{21}=120...630; f_T>150MГц$	E1	B1	C1	E2	B2	C2
X1	UMX1N	ROHM	2xNPN	$V_{CB0}=50B; I_C=100mA;$ $P_D(com)=300mBT; h_{21}>120$	E1	B1	C2	E2	B2	C1
X11	UMX11N	ROHM	2xNPN	$V_{CB0}=25B; I_C=20mA; h_{21}=39...180;$ $f_T>700MГц$	E1	B1	B2	C2	E2	C1
X2	UMX2N	ROHM	2xNPN	$V_{CB0}=50B; I_C=100mA;$ $P_D(com)=300mBT; h_{21}>120$	E1	E2	B2	C2	B1	C1
X3	UMX3N	ROHM	2xNPN	$V_{CB0}=50B; I_C=100mA;$ $P_D(com)=300mBT; h_{21}>120$	E1	B1	B2	C2	E2	C1
X4	UMX4N	ROHM	2xNPN	$V_{CB0}=30B; I_C=50mA;$ $P_D(com)=300mBT; h_{21}=56...180;$ $f_T>1500MГц$	E1	B1	B2	C2	E2	C1
X6	UMX6N	ROHM	2xNPN	$V_{CB0}=40B; I_C=50mA;$ $P_D(com)=300mBT; h_{21}>56;$ $f_T>300MГц$	E1	E2	B2	C2	B1	C1
Z1	UMZ1N	ROHM	D-PNP(2) + D-NPN(1)	$V_{CB0}=50B; I_C=100mA;$ $P_D(com)=300mBT; h_{21}=120...560;$ $f_T>400MГц$	E1	B1	C2	E2	B2	C1
Z2	UMZ2N	ROHM	D-PNP(1) + D-NPN(2)	$V_{CB0}=50B; I_C=100mA;$ $P_D(com)=300mBT; h_{21}=120...560;$ $f_T>180MГц$	E1	B1	B2	C2	E2	C1

SOT346
SC-59

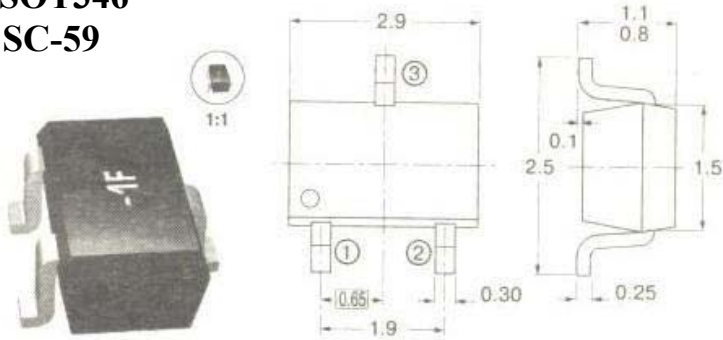

Код	Типономинал	Фирма	Функция	Особенности	Цоколевка		
					1	2	3
03	DTC143TKA	ROHM	D-NPN	$V_{CB0}=50B; I_C=100mA; P_D=200mBT; h_{21}=100...600; f_T>250MГц; R1=4.7kOM$	B	E	C
04	DTC114TKA	ROHM	D-NPN	$V_{CB0}=50B; I_C=100mA; P_D=200mBT; h_{21}=100...600; f_T>250MГц; R2=10kOM$	B	E	C
05	DTC124TKA	ROHM	D-NPN	$V_{CB0}=50B; I_C=100mA; P_D=200mBT; h_{21}=100...600; f_T>250MГц; R1=22kOM$	B	E	C
06	DTC144TKA	ROHM	D-NPN	$V_{CB0}=50B; I_C=100mA; P_D=200mBT; h_{21}=100...600; f_T>250MГц; R1=47kOM$	B	E	C
09	DTC115TKA	ROHM	D-NPN	$V_{CB0}=50B; I_C=100mA; P_D=200mBT; h_{21}=100...600; f_T>250MГц; R1=100kOM$	B	E	C
0A	DTC125TKA	ROHM	D-NPN	$V_{CB0}=50B; I_C=100mA; P_D=200mBT; h_{21}=100...600; f_T>250MГц; R1=200kOM$	B	E	C
10X	02CZ10	TOSH	DZ	$V_Z(I_{ZT}=5mA)=9.40...10.60B; I_L(V_R=8.0B)<0.5mA; Z_{ZT}(I_{ZT}=0.5mA)<120OM$	A	nc	K
11X	02CZ11	TOSH	DZ	$V_Z(I_{ZT}=5mA)=10.40...11.60B; I_L(V_R=8.5B)<0.5mA; Z_{ZT}(I_{ZT}=0.5mA)<120OM$	A	nc	K
12	DTA123EKA	ROHM	D-PNP	$V_{CB0}=-50B; I_C=-100mA; P_D=200mBT; h_{21}>20; f_T>250MГц; R1/R2=2.2/2.2kOM$	B	E	C
12X	02CZ12	TOSH	DZ	$V_Z(I_{ZT}=5mA)=11.40...12.60B; I_L(V_R=9.0B)<0.5mA; Z_{ZT}(I_{ZT}=0.5mA)<110OM$	A	nc	K
13	DTA143EKA	ROHM	D-PNP	$V_{CB0}=-50B; I_C=-100mA; P_D=200mBT; h_{21}>20; f_T>250MГц; R1/R2=4.7/4.7kOM$	B	E	C
13X	02CZ13	TOSH	DZ	$V_Z(I_{ZT}=5mA)=12.40...14.10B; I_L(V_R=10B)<0.5mA; Z_{ZT}(I_{ZT}=0.5mA)<110OM$	A	nc	K
14	DTA114EKA	ROHM	D-PNP	$V_{CB0}=-50B; I_C=-100mA; P_D=200mBT; h_{21}>30; f_T>250MГц; R1/R2=10/10kOM$	B	E	C
15	DTA124EKA	ROHM	D-PNP	$V_{CB0}=-50B; I_C=30mA; P_D=200mBT; h_{21}>56; f_T>250MГц; R1/R2=22/22kOM$	B	E	C
15X	02CZ15	TOSH	DZ	$V_Z(I_{ZT}=5mA)=13.80...15.60B; I_L(V_R=11B)<0.5mA; Z_{ZT}(I_{ZT}=0.5mA)<110OM$	A	nc	K
16	DTA144EKA	ROHM	D-PNP	$V_{CB0}=-50B; I_C=30mA; P_D=200mBT; h_{21}>68; f_T>250MГц; R1/R2=47/47kOM$	B	E	C
16X	02CZ16	TOSH	DZ	$V_Z(I_{ZT}=5mA)=15.30...17.10B; I_L(V_R=12B)<0.5mA; Z_{ZT}(I_{ZT}=0.5mA)<150OM$	A	nc	K
18X	02CZ18	TOSH	DZ	$V_Z(I_{ZT}=5mA)=16.80...19.10B; I_L(V_R=14B)<0.5mA; Z_{ZT}(I_{ZT}=0.5mA)<150OM$	A	nc	K
19	DTA115EKA	ROHM	D-PNP	$V_{CB0}=-50B; I_C=30mA; P_D=200mBT; h_{21}>82; f_T>250MГц; R1/R2=100/100kOM$	B	E	C
1T1	SST5101	ROHM	PNP	$V_{CB0}=-60B; I_C=-200mA; h_{21}=200...400; f_T>125MГц;$	B	E	C
2-0X	02CZ2.0	TOSH	DZ	$V_Z(I_{ZT}=5mA)=1.85...2.15B; I_L(V_R=0.5B)<120mA; Z_{ZT}(I_{ZT}=0.5mA)<1000OM$	A	nc	K
2-2X	02CZ2.2	TOSH	DZ	$V_Z(I_{ZT}=5mA)=2.05...2.38B; I_L(V_R=1.0B)<120mA; Z_{ZT}(I_{ZT}=0.5mA)<1000OM$	A	nc	K
2-4X	02CZ2.4	TOSH	DZ	$V_Z(I_{ZT}=5mA)=2.28...2.60B; I_L(V_R=1.0B)<120mA; Z_{ZT}(I_{ZT}=0.5mA)<1000OM$	A	nc	K
2-7X	02CZ2.7	TOSH	DZ	$V_Z(I_{ZT}=5mA)=2.50...2.90B; I_L(V_R=1.0B)<120mA; Z_{ZT}(I_{ZT}=0.5mA)<1000OM$	A	nc	K
20X	02CZ20	TOSH	DZ	$V_Z(I_{ZT}=5mA)=18.80...21.20B; I_L(V_R=15B)<0.5mA; Z_{ZT}(I_{ZT}=0.5mA)<2000OM$	A	nc	K
22	DTC123EKA	ROHM	D-NPN	$V_{CB0}=50B; I_C=100mA; P_D=200mBT; h_{21}>20; f_T>250MГц; R1/R2=2.2/2.2kOM$	B	E	C
22X	02CZ22	TOSH	DZ	$V_Z(I_{ZT}=5mA)=20.80...23.30B; I_L(V_R=17B)<0.5mA; Z_{ZT}(I_{ZT}=0.5mA)<2000OM$	A	nc	K
23	DTC143EKA	ROHM	D-NPN	$V_{CB0}=50B; I_C=100mA; P_D=200mBT; h_{21}>20; f_T>250MГц; R1/R2=4.7/4.7kOM$	B	E	C
24	DTC114EKA	ROHM	D-NPN	$V_{CB0}=50B; I_C=100mA; P_D=200mBT; h_{21}>30; f_T>250MГц; R1/R2=10/10kOM$	B	E	C
24X	02CZ24	TOSH	DZ	$V_Z(I_{ZT}=5mA)=22.80...25.60B; I_L(V_R=19B)<0.5mA; Z_{ZT}(I_{ZT}=0.5mA)<2000OM$	A	nc	K

SOT346 (продолжение)

Код	Типономинал	Фирма	Функция	Особенности	Цоколевка		
					1	2	3
25	DTC124EKA	ROHM	D-NPN	$V_{CB0}=50B; I_C=30mA; P_D=200mBT; h_{21}>56; f_T>250MГц;$ $R1/R2=22/22kOM$	B	E	C
26	DTC144EKA	ROHM	D-NPN	$V_{CB0}=50B; I_C=30mA; P_D=200mBT; h_{21}>68; f_T>250MГц;$ $R1/R2=47/47kOM$	B	E	C
27X	02CZ27	TOSH	DZ	$V_Z(I_{ZT}=2mA)=25.10...28.90B; I_L(V_R=21B)<0.5mA;$ $Z_{ZT}(I_{ZT}=0.5mA)<250OM$	A	nc	K
29	DTC115EKA	ROHM	D-NPN	$V_{CB0}=50B; I_C=20mA; P_D=200mBT; h_{21}>82; f_T>250MГц;$ $R1/R2=100/100kOM$	B	E	C
3-0X	02CZ3.0	TOSH	DZ	$V_Z(I_{ZT}=5mA)=2.80...3.20B; I_L(V_R=1.0B)<50mA;$ $Z_{ZT}(I_{ZT}=0.5mA)<1000OM$	A	nc	K
3-3X	02CZ3.3	TOSH	DZ	$V_Z(I_{ZT}=5mA)=3.10...3.50B; I_L(V_R=1.0B)<20mA;$ $Z_{ZT}(I_{ZT}=0.5mA)<1000OM$	A	nc	K
3-6X	02CZ3.6	TOSH	DZ	$V_Z(I_{ZT}=5mA)=3.40...3.80B; I_L(V_R=1.0B)<10mA;$ $Z_{ZT}(I_{ZT}=0.5mA)<1000OM$	A	nc	K
3-9X	02CZ3.9	TOSH	DZ	$V_Z(I_{ZT}=5mA)=3.70...4.10B; I_L(V_R=1.0B)<10mA;$ $Z_{ZT}(I_{ZT}=0.5mA)<1000OM$	A	nc	K
30X	02CZ30	TOSH	DZ	$V_Z(I_{ZT}=2mA)=28.00...32.00B; I_L(V_R=23B)<0.5mA;$ $Z_{ZT}(I_{ZT}=0.5mA)<250OM$	A	nc	K
33	DTA143XKA	ROHM	D-PNP	$V_{CB0}=-50B; I_C=-100mA; P_D=200mBT; h_{21}>30; f_T>250MГц;$ $R1/R2=4.7/10kOM$	B	E	C
33X	02CZ33	TOSH	DZ	$V_Z(I_{ZT}=2mA)=31.00...35.00B; I_L(V_R=25B)<0.5mA;$ $Z_{ZT}(I_{ZT}=0.5mA)<250OM$	A	nc	K
35	DTA124XKA	ROHM	D-PNP	$V_{CB0}=-50B; I_C=-100mA; P_D=200mBT; h_{21}>68; f_T>250MГц;$ $R1/R2=22/47kOM$	B	E	C
36X	02CZ36	TOSH	DZ	$V_Z(I_{ZT}=2mA)=34.00...38.00B; I_L(V_R=27B)<0.5mA;$ $Z_{ZT}(I_{ZT}=0.5mA)<250OM$	A	nc	K
39X	02CZ39	TOSH	DZ	$V_Z(I_{ZT}=2mA)=37.00...41.00B; I_L(V_R=30B)<0.5mA;$ $Z_{ZT}(I_{ZT}=0.5mA)<250OM$	A	nc	K
4-3X	02CZ4.3	TOSH	DZ	$V_Z(I_{ZT}=5mA)=4.00...4.50B; I_L(V_R=1.0B)<5mA;$ $Z_{ZT}(I_{ZT}=0.5mA)<1000OM$	A	nc	K
4-7X	02CZ4.7	TOSH	DZ	$V_Z(I_{ZT}=5mA)=4.40...4.90B; I_L(V_R=1.0B)<5mA;$ $Z_{ZT}(I_{ZT}=0.5mA)<1000OM$	A	nc	K
43	DTA143XKA	ROHM	D-PNP	$V_{CB0}=50B; I_C=100mA; P_D=200mBT; h_{21}>30; f_T>250MГц;$ $R1/R2=4.7/10kOM$	B	E	C
43X	02CZ43	TOSH	DZ	$V_Z(I_{ZT}=5mA)=40.00...45.00B; I_L(V_R=33B)<0.5mA;$ $Z_{ZT}(I_{ZT}=0.5mA)<250OM$	A	nc	K
45	DTC124XKA	ROHM	D-PNP	$V_{CB0}=50B; I_C=100mA; P_D=200mBT; h_{21}>68; f_T>250MГц;$ $R1/R2=22/47kOM$	B	E	C
47X	02CZ47	TOSH	DZ	$V_Z(I_{ZT}=5mA)=44.00...49.00B; I_L(V_R=36B)<0.5mA;$ $Z_{ZT}(I_{ZT}=0.5mA)<250OM$	A	nc	K
5-1X	02CZ5.1	TOSH	DZ	$V_Z(I_{ZT}=5mA)=4.80...5.40B; I_L(V_R=1.5B)<1mA;$ $Z_{ZT}(I_{ZT}=0.5mA)<1000OM$	A	nc	K
5-6X	02CZ5.6	TOSH	DZ	$V_Z(I_{ZT}=5mA)=5.30...6.00B; I_L(V_R=2.5B)<1mA;$ $Z_{ZT}(I_{ZT}=0.5mA)<900OM$	A	nc	K
52	DTA123YKA	ROHM	D-PNP	$V_{CB0}=-50B; I_C=-100mA; P_D=200mBT; h_{21}>33; f_T>250MГц;$ $R1/R2=2.2/10kOM$	B	E	C
54	DTA114YKA	ROHM	D-PNP	$V_{CB0}=-50B; I_C=-100mA; P_D=200mBT; h_{21}>68; f_T>250MГц;$ $R1/R2=10/4.7kOM$	B	E	C
6-2X	02CZ6.2	TOSH	DZ	$V_Z(I_{ZT}=5mA)=5.80...6.60B; I_L(V_R=3.0B)<1mA;$ $Z_{ZT}(I_{ZT}=0.5mA)<500OM$	A	nc	K
6-8X	02CZ6.8	TOSH	DZ	$V_Z(I_{ZT}=5mA)=6.40...7.20B; I_L(V_R=5.0B)<0.5mA;$ $Z_{ZT}(I_{ZT}=0.5mA)<150OM$	A	nc	K
62	DTC123YKA	ROHM	D-NPN	$V_{CB0}=50B; I_C=100mA; P_D=200mBT; h_{21}>33; f_T>250MГц;$ $R1/R2=2.2/10kOM$	B	E	C
64	DTC114YKA	ROHM	D-NPN	$V_{CB0}=50B; I_C=100mA; P_D=200mBT; h_{21}>68; f_T>250MГц;$ $R1/R2=10/4.7kOM$	B	E	C
7-5X	02CZ7.5	TOSH	DZ	$V_Z(I_{ZT}=5mA)=7.00...7.90B; I_L(V_R=6.0B)<0.5mA;$ $Z_{ZT}(I_{ZT}=0.5mA)<120OM$	A	nc	K
74	DTA114WKA	ROHM	D-PNP	$V_{CB0}=-50B; I_C=-100mA; P_D=200mBT; h_{21}>24; f_T>250MГц;$ $R1/R2=10/4.7kOM$	B	E	C
76	DTA144WKA	ROHM	D-PNP	$V_{CB0}=-50B; I_C=30mA; P_D=200mBT; h_{21}>56; f_T>250MГц;$ $R1/R2=47/22kOM$	B	E	C
8-2X	02CZ8.2	TOSH	DZ	$V_Z(I_{ZT}=5mA)=7.70...8.70B; I_L(V_R=6.5B)<0.5mA;$ $Z_{ZT}(I_{ZT}=0.5mA)<120OM$	A	nc	K
84	DTC114WKA	ROHM	D-NPN	$V_{CB0}=50B; I_C=100mA; P_D=200mBT; h_{21}>24; f_T>250MГц;$ $R1/R2=10/4.7kOM$	B	E	C
86	DTC144WKA	ROHM	D-NPN	$V_{CB0}=50B; I_C=30mA; P_D=200mBT; h_{21}>56; f_T>250MГц;$ $R1/R2=47/22kOM$	B	E	C
9-1X	02CZ9.1	TOSH	DZ	$V_Z(I_{ZT}=5mA)=8.50...9.60B; I_L(V_R=7.0B)<0.5mA;$ $Z_{ZT}(I_{ZT}=0.5mA)<120OM$	A	nc	K
93	DTA143TKA	ROHM	D-PNP	$V_{CB0}=-50B; I_C=-100mA; P_D=200mBT; h_{21}=100...600; f_T>250MГц;$ $R1=4.7kOM$	B	E	C
94	DTA114TKA	ROHM	D-PNP	$V_{CB0}=-50B; I_C=-100mA; P_D=200mBT; h_{21}=100...600; f_T>250MГц;$ $R1=10kOM$	B	E	C
95	DTA124TKA	ROHM	D-PNP	$V_{CB0}=-50B; I_C=-100mA; P_D=200mBT; h_{21}=100...600; f_T>250MГц;$ $R1=22kOM$	B	E	C

SOT346 (продолжение)

Код	Типономинал	Фирма	Функция	Особенности	Цоколевка		
					1	2	3
96	DTA144TKA	ROHM	D-PNP	$V_{CB0}=-50B$; $I_C=-100_{mA}$; $P_D=200_{mBT}$; $h_{21}=100...600$; $f_T>250_{MHz}$; $R_1=47_{kOM}$	B	E	C
99	DTA115TKA	ROHM	D-PNP	$V_{CB0}=-50B$; $I_C=-100_{mA}$; $P_D=200_{mBT}$; $h_{21}=100...600$; $f_T>250_{MHz}$; $R_1=100_{kOM}$	B	E	C
9A	DTA125TKA	ROHM	D-PNP	$V_{CB0}=-50B$; $I_C=-100_{mA}$; $P_D=200_{mBT}$; $h_{21}=100...600$; $f_T>250_{MHz}$; $R_1=200_{kOM}$	B	E	C
A3	1SS181	TOSH	2xDI	$V_R<80B$; $I_F<100A$; $V_F(I_F=100_{mA})<1.2B$; $I_R<0.5_{mA}$; $t_{RR}<4_{нс}$	K1	K2	A1 A2
A9	1SS294	TOSH	SHD	$V_R>40B$; $V_F(I_F=100_{mA})<0.6B$; $I_R(V_R=40B)<5_{mA}$; $C_T<25_{пФ}$	A	nc	K
AAQ	2SD1757KQ	ROHM	NPN	$V_{CB0}=30B$; $I_C=500_{mA}$; $P_D=200_{mBT}$; $h_{21}=120...270$; $f_T>150_{MHz}$	B	E	C
AAR	2SD1757KR	ROHM	NPN	$V_{CB0}=30B$; $I_C=500_{mA}$; $P_D=200_{mBT}$; $h_{21}=180...390$; $f_T>150_{MHz}$	B	E	C
AAS	2SD1757KS	ROHM	NPN	$V_{CB0}=30B$; $I_C=500_{mA}$; $P_D=200_{mBT}$; $h_{21}=270...560$; $f_T>150_{MHz}$	B	E	C
ACL	2SC3837KL	ROHM	NPN	$V_{CB0}=30B$; $I_C=50_{mA}$; $P_D=150_{mBT}$; $h_{21}=27...56$; $f_T=1500_{MHz}$	B	E	C
ACM	2SC3837KM	ROHM	NPN	$V_{CB0}=30B$; $I_C=50_{mA}$; $P_D=150_{mBT}$; $h_{21}=39...82$; $f_T=1500_{MHz}$	B	E	C
ACN	2SC3837KN	ROHM	NPN	$V_{CB0}=30B$; $I_C=50_{mA}$; $P_D=150_{mBT}$; $h_{21}=56...120$; $f_T=1500_{MHz}$	B	E	C
ACP	2SC3837KP	ROHM	NPN	$V_{CB0}=30B$; $I_C=50_{mA}$; $P_D=150_{mBT}$; $h_{21}=82...180$; $f_T=1500_{MHz}$	B	E	C
ACQ	2SC3837KQ	ROHM	NPN	$V_{CB0}=30B$; $I_C=50_{mA}$; $P_D=150_{mBT}$; $h_{21}=120...270$; $f_T=1500_{MHz}$	B	E	C
ADL	2SC3838KL	ROHM	NPN	$V_{CB0}=20B$; $I_C=50_{mA}$; $P_D=150_{mBT}$; $h_{21}=27...56$; $f_T=3200_{MHz}$	B	E	C
ADM	2SC3838KM	ROHM	NPN	$V_{CB0}=20B$; $I_C=50_{mA}$; $P_D=150_{mBT}$; $h_{21}=39...82$; $f_T=3200_{MHz}$	B	E	C
ADN	2SC3838KN	ROHM	NPN	$V_{CB0}=20B$; $I_C=50_{mA}$; $P_D=150_{mBT}$; $h_{21}=56...120$; $f_T=3200_{MHz}$	B	E	C
ADP	2SC3838KP	ROHM	NPN	$V_{CB0}=20B$; $I_C=50_{mA}$; $P_D=150_{mBT}$; $h_{21}=82...180$; $f_T=3200_{MHz}$	B	E	C
ADQ	2SC3838KQ	ROHM	NPN	$V_{CB0}=20B$; $I_C=50_{mA}$; $P_D=150_{mBT}$; $h_{21}=120...270$; $f_T=3200_{MHz}$	B	E	C
AEL	2SC3839KL	ROHM	NPN	$V_{CB0}=30B$; $I_C=50_{mA}$; $P_D=150_{mBT}$; $h_{21}=27...56$; $f_T>200_{MHz}$	B	E	C
AEM	2SC3839KM	ROHM	NPN	$V_{CB0}=30B$; $I_C=50_{mA}$; $P_D=150_{mBT}$; $h_{21}=39...82$; $f_T>200_{MHz}$	B	E	C
AEN	2SC3839KN	ROHM	NPN	$V_{CB0}=30B$; $I_C=50_{mA}$; $P_D=150_{mBT}$; $h_{21}=56...120$; $f_T>200_{MHz}$	B	E	C
AEP	2SC3839KP	ROHM	NPN	$V_{CB0}=30B$; $I_C=50_{mA}$; $P_D=150_{mBT}$; $h_{21}=82...180$; $f_T>200_{MHz}$	B	E	C
AEQ	2SC3839KQ	ROHM	NPN	$V_{CB0}=30B$; $I_C=50_{mA}$; $P_D=150_{mBT}$; $h_{21}=120...270$; $f_T>200_{MHz}$	B	E	C
AFP	2SD1781KP	ROHM	NPN	$V_{CB0}=40B$; $I_C=800_{mA}$; $P_D=200_{mBT}$; $h_{21}=82...180$; $f_T>150_{MHz}$	B	E	C
AFQ	2SD1781KQ	ROHM	NPN	$V_{CB0}=40B$; $I_C=800_{mA}$; $P_D=200_{mBT}$; $h_{21}=120...270$; $f_T>150_{MHz}$	B	E	C
AFR	2SD1781KR	ROHM	NPN	$V_{CB0}=40B$; $I_C=800_{mA}$; $P_D=200_{mBT}$; $h_{21}=180...390$; $f_T>150_{MHz}$	B	E	C
AHP	2SB1197KP	ROHM	PNP	$V_{CB0}=-40B$; $I_C=-800_{mA}$; $P_D=200_{mBT}$; $h_{21}=82...180$; $f_T>200_{MHz}$	B	E	C
AHQ	2SB1197KQ	ROHM	PNP	$V_{CB0}=-40B$; $I_C=-800_{mA}$; $P_D=200_{mBT}$; $h_{21}=120...270$; $f_T>200_{MHz}$	B	E	C
AHR	2SB1197KR	ROHM	PNP	$V_{CB0}=-40B$; $I_C=-800_{mA}$; $P_D=200_{mBT}$; $h_{21}=180...390$; $f_T>200_{MHz}$	B	E	C
AJP	2SD1782KP	ROHM	NPN	$V_{CB0}=80B$; $I_C=500_{mA}$; $P_D=200_{mBT}$; $h_{21}=82...180$; $f_T>180_{MHz}$	B	E	C
AJQ	2SD1782KQ	ROHM	NPN	$V_{CB0}=80B$; $I_C=500_{mA}$; $P_D=200_{mBT}$; $h_{21}=120...270$; $f_T>180_{MHz}$	B	E	C
AJR	2SD1782KR	ROHM	NPN	$V_{CB0}=80B$; $I_C=500_{mA}$; $P_D=200_{mBT}$; $h_{21}=180...390$; $f_T>180_{MHz}$	B	E	C
AKP	2SB1198KP	ROHM	PNP	$V_{CB0}=-80B$; $I_C=-500_{mA}$; $P_D=200_{mBT}$; $h_{21}=82...180$; $f_T>180_{MHz}$	B	E	C
AKQ	2SB1198KQ	ROHM	PNP	$V_{CB0}=-80B$; $I_C=-500_{mA}$; $P_D=200_{mBT}$; $h_{21}=120...270$; $f_T>180_{MHz}$	B	E	C
AKR	2SB1198KR	ROHM	PNP	$V_{CB0}=-80B$; $I_C=-500_{mA}$; $P_D=200_{mBT}$; $h_{21}=180...390$; $f_T>180_{MHz}$	B	E	C
ALM	2SC3802KM	ROHM	NPN	$V_{CB0}=30B$; $I_C=30_{mA}$; $P_D=200_{mBT}$; $h_{21}=39...82$; $f_T>110_{MHz}$	B	E	C
ALN	2SC3802KN	ROHM	NPN	$V_{CB0}=30B$; $I_C=30_{mA}$; $P_D=200_{mBT}$; $h_{21}=56...120$; $f_T>110_{MHz}$	B	E	C
ALP	2SC3802KP	ROHM	NPN	$V_{CB0}=30B$; $I_C=30_{mA}$; $P_D=200_{mBT}$; $h_{21}=82...180$; $f_T>110_{MHz}$	B	E	C
ALQ	2SC3802KQ	ROHM	NPN	$V_{CB0}=30B$; $I_C=30_{mA}$; $P_D=200_{mBT}$; $h_{21}=120...270$; $f_T>110_{MHz}$	B	E	C
AMN	2SC4018KN	ROHM	NPN	$V_{CB0}=40B$; $I_C=100_{mA}$; $P_D=200_{mBT}$; $h_{21}=56...120$; $f_T>230_{MHz}$	B	E	C
AMP	2SC4018KP	ROHM	NPN	$V_{CB0}=40B$; $I_C=100_{mA}$; $P_D=200_{mBT}$; $h_{21}=82...180$; $f_T>230_{MHz}$	B	E	C
AN	2SC2413KN	ROHM	NPN	$V_{CB0}=40B$; $I_C=50_{mA}$; $P_D=200_{mBT}$; $h_{21}=56...120$; $f_T=300_{MHz}$	B	E	C
AN	2SC2532	TOSH	NPN	$V_{CE0}=40B$; $I_C=300_{mA}$; $P_D=150_{mBT}$; $h_{21}>5000$	B	E	C
ANM	2SC4061KM	ROHM	NPN	$V_{CB0}=30B$; $I_C=100_{mA}$; $P_D=200_{mBT}$; $h_{21}=39...82$; $f_T>100_{MHz}$	B	E	C
ANN	2SC4061KN	ROHM	NPN	$V_{CB0}=30B$; $I_C=100_{mA}$; $P_D=200_{mBT}$; $h_{21}=56...120$; $f_T>100_{MHz}$	B	E	C
ANP	2SC4061KP	ROHM	NPN	$V_{CB0}=30B$; $I_C=100_{mA}$; $P_D=200_{mBT}$; $h_{21}=82...180$; $f_T>100_{MHz}$	B	E	C
AP	2SC2413KP	ROHM	NPN	$V_{CB0}=40B$; $I_C=50_{mA}$; $P_D=200_{mBT}$; $h_{21}=82...180$; $f_T=300_{MHz}$	B	E	C
AP	2SC4074M	ROHM	NPN	$V_{CB0}=18B$; $I_C=50_{mA}$; $P_D=150_{mBT}$; $h_{21}=270$; $f_T>1500_{MHz}$	B	E	C
AQ	2SC2413KQ	ROHM	NPN	$V_{CB0}=40B$; $I_C=50_{mA}$; $P_D=200_{mBT}$; $h_{21}=120...270$; $f_T=300_{MHz}$	B	E	C
AQP	2SB1051KP	ROHM	PNP	$V_{CB0}=-40B$; $I_C=-1000_{mA}$; $P_D=200_{mBT}$; $h_{21}=82...180$; $f_T>150_{MHz}$	B	E	C
AQQ	2SB1051KQ	ROHM	PNP	$V_{CB0}=-40B$; $I_C=-1000_{mA}$; $P_D=200_{mBT}$; $h_{21}=120...270$; $f_T>150_{MHz}$	B	E	C
AQR	2SB1051KR	ROHM	PNP	$V_{CB0}=-40B$; $I_C=-1000_{mA}$; $P_D=200_{mBT}$; $h_{21}=180...390$; $f_T>150_{MHz}$	B	E	C
ATQ	2SC4326KQ	ROHM	NPN	$V_{CB0}=12B$; $I_C=50_{mA}$; $P_D=150_{mBT}$; $h_{21}=120...270$; $f_T>800_{MHz}$	B	E	C
ATR	2SC4326KR	ROHM	NPN	$V_{CB0}=12B$; $I_C=50_{mA}$; $P_D=150_{mBT}$; $h_{21}=180...390$; $f_T>800_{MHz}$	B	E	C
ATS	2SC4326KS	ROHM	NPN	$V_{CB0}=12B$; $I_C=50_{mA}$; $P_D=150_{mBT}$; $h_{21}=270...560$; $f_T>800_{MHz}$	B	E	C

SOT346 (продолжение)

Код	Типономинал	Фирма	Функция	Особенности	Цоколевка		
					1	2	3
B3	1SS184	TOSH	2xDI	$V_R < 80B; I_F < 100A; V_F(I_F = 100mA) < 1.2B; I_R < 0.5mA; t_{RR} < 4нс$	A1	A2	K1 K2
B9	1SS311	TOSH	DI	$V_R < 40B; I_F < 100A; V_F(I_F = 100mA) < 1.2B; I_R < 1.0mA$	A	nc	K
BBU	2SD2114KU	ROHM	NPN	$V_{CB0} = 25B; I_C = 500mA; P_D = 200mBT; h_{21} = 560...1200; f_T > 350MГц$	B	E	C
BBV	2SD2114KV	ROHM	NPN	$V_{CB0} = 25B; I_C = 500mA; P_D = 200mBT; h_{21} = 820...1800; f_T > 350MГц$	B	E	C
BBW	2SD2114KW	ROHM	NPN	$V_{CB0} = 25B; I_C = 500mA; P_D = 200mBT; h_{21} = 1200...2700; f_T > 350MГц$	B	E	C
BDM	2SA1733KM	ROHM	PNP	$V_{CB0} = -30B; I_C = -30mA; P_D = 200mBT; h_{21} = 39...82; f_T > 400MГц$	B	E	C
BDN	2SA1733KN	ROHM	PNP	$V_{CB0} = -30B; I_C = -30mA; P_D = 200mBT; h_{21} = 56...120; f_T > 400MГц$	B	E	C
BDP	2SA1733KP	ROHM	PNP	$V_{CB0} = -30B; I_C = -30mA; P_D = 200mBT; h_{21} = 82...180; f_T > 400MГц$	B	E	C
BFR	2SC4642KR	ROHM	NPN	$V_{CB0} = 50B; I_C = 100mA; P_D = 200mBT; h_{21} = 180...390; f_T > 180MГц$	B	E	C
BFS	2SC4642KS	ROHM	NPN	$V_{CB0} = 50B; I_C = 100mA; P_D = 200mBT; h_{21} = 270...560; f_T > 180MГц$	B	E	C
BHM	2SC4699KM	ROHM	NPN	$V_{CB0} = 25B; I_C = 200mA; P_D = 200mBT; h_{21} = 39...82; f_T > 250MГц$	B	E	C
BHN	2SC4699KN	ROHM	NPN	$V_{CB0} = 25B; I_C = 200mA; P_D = 200mBT; h_{21} = 56...120; f_T > 250MГц$	B	E	C
BHP	2SC4699KP	ROHM	NPN	$V_{CB0} = 25B; I_C = 200mA; P_D = 200mBT; h_{21} = 82...180; f_T > 250MГц$	B	E	C
BJU	2SD2226KU	ROHM	NPN	$V_{CB0} = 60B; I_C = 150mA; P_D = 200mBT; h_{21} = 560...1200; f_T > 250MГц$	B	E	C
BJV	2SD2226KV	ROHM	NPN	$V_{CB0} = 60B; I_C = 150mA; P_D = 200mBT; h_{21} = 820...1800; f_T > 250MГц$	B	E	C
BJW	2SD2226KW	ROHM	NPN	$V_{CB0} = 60B; I_C = 150mA; P_D = 200mBT; h_{21} = 1200...2700; f_T > 250MГц$	B	E	C
BLL	2SC4771KL	ROHM	NPN	$V_{CB0} = 30B; I_C = 50mA; P_D = 200mBT; h_{21} = 27...56; f_T > 600MГц$	B	E	C
BLM	2SC4771KM	ROHM	NPN	$V_{CB0} = 30B; I_C = 50mA; P_D = 200mBT; h_{21} = 39...82; f_T > 600MГц$	B	E	C
BLN	2SC4771KN	ROHM	NPN	$V_{CB0} = 30B; I_C = 50mA; P_D = 200mBT; h_{21} = 56...120; f_T > 600MГц$	B	E	C
BLP	2SC4771KP	ROHM	NPN	$V_{CB0} = 30B; I_C = 50mA; P_D = 200mBT; h_{21} = 82...180; f_T > 600MГц$	B	E	C
BMQ	2SC4713KQ	ROHM	NPN	$V_{CB0} = 12B; I_C = 50mA; P_D = 200mBT; h_{21} = 120...270; f_T = 800MГц$	B	E	C
BMR	2SC4713KR	ROHM	NPN	$V_{CB0} = 12B; I_C = 50mA; P_D = 200mBT; h_{21} = 180...390; f_T = 800MГц$	B	E	C
BMS	2SC4713KS	ROHM	NPN	$V_{CB0} = 12B; I_C = 50mA; P_D = 200mBT; h_{21} = 270...560; f_T = 800MГц$	B	E	C
BQ	2SC2412KQ	ROHM	NPN	$V_{CB0} = 50B; I_C = 150mA; P_D = 200mBT; h_{21} = 120...270; f_T > 180MГц$	B	E	C
BR	2SC2412KR	ROHM	NPN	$V_{CB0} = 50B; I_C = 150mA; P_D = 200mBT; h_{21} = 180...390; f_T > 180MГц$	B	E	C
BS	2SC2412KS	ROHM	NPN	$V_{CB0} = 50B; I_C = 150mA; P_D = 200mBT; h_{21} = 270...560; f_T > 180MГц$	B	E	C
C3	1SS226	TOSH	2xDI	$V_R < 80B; I_F < 100A; V_F(I_F = 100mA) < 1.2B; I_R < 0.5mA; t_{RR} < 4нс$	A1	K2	K1 A2
C9	1SS307	TOSH	DI	$V_R < 30B; I_F < 100A; V_F(I_F = 100mA) < 1.3B; I_R < 0.01mA$	A	nc	K
CP	2SC2411KP	ROHM	NPN	$V_{CB0} = 40B; I_C = 500mA; P_D = 200mBT; h_{21} = 82...180; f_T > 250MГц$	B	E	C
CQ	2SC2411KQ	ROHM	NPN	$V_{CB0} = 40B; I_C = 500mA; P_D = 200mBT; h_{21} = 120...270; f_T > 250MГц$	B	E	C
CR	2SC2411KR	ROHM	NPN	$V_{CB0} = 40B; I_C = 500mA; P_D = 200mBT; h_{21} = 180...390; f_T > 250MГц$	B	E	C
D3	1SS187	TOSH	DI	$V_R < 80B; I_F < 100A; V_F(I_F = 100mA) < 1.2B; I_R < 0.5mA; t_{RR} < 4нс$	K	nc	A
DE	2SA1037AKLNE	ROHM	PNP	$V_{CB0} = -50B; I_C = -150mA; P_D = 200mBT; h_{21} = 390...820; f_T > 140MГц$	B	E	C
DI-	2SC3867	HIT	NPN	$U_{CB0} = 20B; I_C = 50mA; P_D = 150mBT; h_{21} = 20...200; f_T > 1.4ГГц$	E	B	C
DR	2SA1037AKLNR	ROHM	PNP	$V_{CB0} = -50B; I_C = -150mA; P_D = 200mBT; h_{21} = 180...390; f_T > 140MГц$	B	E	C
DS	2SA1037AKLNS	ROHM	PNP	$V_{CB0} = -50B; I_C = -150mA; P_D = 200mBT; h_{21} = 270...560; f_T > 140MГц$	B	E	C
E11	DTA113ZKA	ROHM	PNP	$V_{CB0} = -50B; I_C = -100mA; P_D = 200mBT; h_{21} > 33; f_T > 250MГц; R1/R2 = 1/10kOm$	B	E	C
E13	DTA143ZKA	ROHM	PNP	$V_{CB0} = -50B; I_C = -100mA; P_D = 200mBT; h_{21} > 80; f_T > 250MГц; R1/R2 = 4.7/47kOm$	B	E	C
E21	DTC113ZKA	ROHM	NPN	$V_{CB0} = 50B; I_C = 100mA; P_D = 200mBT; h_{21} > 33; f_T > 250MГц; R1/R2 = 1/10kOm$	B	E	C
E23	DTC143ZKA	ROHM	NPN	$V_{CB0} = 50B; I_C = 100mA; P_D = 200mBT; h_{21} > 80; f_T > 250MГц; R1/R2 = 4.7/47kOm$	B	E	C
E3	1SS190	TOSH	DI	$V_R < 80B; I_F < 100A; V_F(I_F = 100mA) < 1.2B; I_R < 0.5mA; t_{RR} < 4нс$	nc	K	A
E32	DTA143JKA	ROHM	PNP	$V_{CB0} = -50B; I_C = -100mA; P_D = 200mBT; h_{21} > 80; f_T > 250MГц; R1/R2 = 2.2/47kOm$	B	E	C
E42	DTC143JKA	ROHM	NPN	$V_{CB0} = 50B; I_C = 100mA; P_D = 200mBT; h_{21} > 80; f_T > 250MГц; R1/R2 = 2.2/47kOm$	B	E	C
E56	DTA144VKA	ROHM	PNP	$V_{CB0} = -50B; I_C = -100mA; P_D = 200mBT; h_{21} > 33; f_T > 250MГц; R1/R2 = 47/10kOm$	B	E	C

SOT346 (продолжение)

Код	Типоминал	Фирма	Функция	Особенности	Цоколевка		
					1	2	3
E66	DTC144VKA	ROHM	NPN	$V_{CB0}=50B; I_C=100mA; P_D=200mBт; h_{21}>33; f_T>250MГц; R1/R2=47/10kOM$	B	E	C
E79	DTA115UK	ROHM	PNP	$V_{CB0}=-50B; I_C=-100mA; P_D=200mBт; h_{21}>27; f_T>250MГц$	B	E	C
E89	DTC115UK	ROHM	NPN	$V_{CB0}=50B; I_C=100mA; P_D=200mBт; h_{21}>27; f_T>250MГц$	B	E	C
E92	DTB123TK	ROHM	PNP	$V_{CB0}=-50B; I_C=-500mA; P_D=200mBт; h_{21}=100...600; f_T>200MГц; R1=2.2kOM$	B	E	C
E94	DTB114TK	ROHM	PNP	$V_{CB0}=-50B; I_C=-500mA; P_D=200mBт; h_{21}=100...600; f_T>200MГц; R1=10kOM$	B	E	C
E97	DTB163TK	ROHM	PNP	$V_{CB0}=-50B; I_C=-500mA; P_D=200mBт; h_{21}>100...600; f_T>200MГц$	B	E	C
EC	2SC2732	HIT	NPN	$U_{CB0}=30B; I_C=20mA; P_D=150mBт; h_{21}>30; f_T>700MГц$	B	E	C
F02	DTD123TK	ROHM	NPN	$V_{CB0}=50B; I_C=500mA; P_D=200mBт; h_{21}=100...600; f_T>200MГц; R1=2.2kOM$	B	E	C
F03	DTB143TK	ROHM	PNP	$V_{CB0}=-50B; I_C=-500mA; P_D=200mBт; h_{21}>100...600; f_T>200MГц; R1=4.7kOM$	B	E	C
F04	DTD114TK	ROHM	NPN	$V_{CB0}=50B; I_C=500mA; P_D=200mBт; h_{21}=100...600; f_T>200MГц; R1=10kOM$	B	E	C
F07	DTD163TK	ROHM	NPN	$V_{CB0}=50B; I_C=500mA; P_D=200mBт; h_{21}=100...600; f_T>200MГц$	B	E	C
F11	DTB113EK	ROHM	PNP	$V_{CB0}=-50B; I_C=-500mA; P_D=200mBт; h_{21}>33; f_T>200MГц; R1/R2=1/1kOM$	B	E	C
F12	DTB123EK	ROHM	PNP	$V_{CB0}=-50B; I_C=-500mA; P_D=200mBт; h_{21}>39; f_T>200MГц; R1/R2=2.2/2.2kOM$	B	E	C
F13	DTB143EK	ROHM	PNP	$V_{CB0}=-50B; I_C=-500mA; P_D=200mBт; h_{21}>47; f_T>200MГц; R1/R2=4.7/4.7kOM$	B	E	C
F14	DTB114EK	ROHM	PNP	$V_{CB0}=-50B; I_C=-500mA; P_D=200mBт; h_{21}>56; f_T>200MГц; R1/R2=10/10kOM$	B	E	C
F21	DTD113EK	ROHM	NPN	$V_{CB0}=50B; I_C=500mA; P_D=200mBт; h_{21}>33; f_T>200MГц; R1/R2=1/1kOM$	B	E	C
F22	DTD123EK	ROHM	NPN	$V_{CB0}=50B; I_C=500mA; P_D=200mBт; h_{21}>39; f_T>200MГц; R1/R2=2.2/2.2kOM$	B	E	C
F23	DTD143EK	ROHM	NPN	$V_{CB0}=50B; I_C=500mA; P_D=200mBт; h_{21}>47; f_T>200MГц; R1/R2=4.7/4.7kOM$	B	E	C
F23	DTD143TK	ROHM	NPN	$V_{CB0}=50B; I_C=500mA; P_D=200mBт; h_{21}=100...600; f_T>200MГц; R1=4.7kOM$	B	E	C
F24	DTD114EK	ROHM	NPN	$V_{CB0}=50B; I_C=500mA; P_D=200mBт; h_{21}>56; f_T>200MГц; R1/R2=10/10kOM$	B	E	C
F3	1SS193	TOSH	DI	$V_R<80B; I_F<100A; V_F(I_F=100mA)<1.2B; I_R<0.5mA; t_{RR}<4нс$	A	nc	K
F5	1SS250	TOSH	DI	$V_R<200B; I_F<100A; V_F(I_F=100mA)<1.2B; I_R<1.0mA; t_{RR}<60нс$	A	nc	K
F52	DTB123YK	ROHM	PNP	$V_{CB0}=-50B; I_C=-500mA; P_D=200mBт; h_{21}>56; f_T>200MГц; R1/R2=2.2/10kOM$	B	E	C
F62	DTD123YK	ROHM	NPN	$V_{CB0}=50B; I_C=500mA; P_D=200mBт; h_{21}>56; f_T>200MГц; R1/R2=2.2/10kOM$	B	E	C
F9	1SS321	TOSH	2xSHD	$V_R>10B; V_F(I_F=50mA)<1.0B; I_R(V_R=10B)<0.5mA; C_T<4.5пФ$	A1	A2	K1 K2
FQ	2SA1037AKQ	ROHM	PNP	$V_{CB0}=-50B; I_C=-150mA; P_D=200mBт; h_{21}=120...270; f_T>140MГц$	B	E	C
FR	2SA1037AKR	ROHM	PNP	$V_{CB0}=-50B; I_C=-150mA; P_D=200mBт; h_{21}=180...390; f_T>140MГц$	B	E	C
FS	2SA1037AKS	ROHM	PNP	$V_{CB0}=-50B; I_C=-150mA; P_D=200mBт; h_{21}=270...560; f_T>140MГц$	B	E	C
G08	DTD133HK	ROHM	NPN	$V_{CB0}=50B; I_C=500mA; P_D=200mBт; h_{21}>56; f_T>200MГц; R1/R2=3.3/10kOM$	B	E	C
G11	DTB113ZK	ROHM	PNP	$V_{CB0}=-50B; I_C=-500mA; P_D=200mBт; h_{21}>56; f_T>200MГц; R1/R2=1/10kOM$	B	E	C
G21	DTD113ZK	ROHM	NPN	$V_{CB0}=50B; I_C=500mA; P_D=200mBт; h_{21}>56; f_T>200MГц; R1/R2=1/10kOM$	B	E	C
G3	1SS196	TOSH	DI	$V_R<80B; I_F<100A; V_F(I_F=100mA)<1.2B; I_R<0.5mA; t_{RR}<4нс$	nc	A	K
G3C	DTB122JK	ROHM	PNP	$V_{CB0}=-50B; I_C=-500mA; P_D=200mBт; h_{21}>47; f_T>250MГц; R1/R2=0.22/4.7kOM$	B	E	C
G4C	DTD122JK	ROHM	NPN	$V_{CB0}=50B; I_C=500mA; P_D=200mBт; h_{21}>47; f_T>250MГц; R1/R2=0.22/4.7kOM$	B	E	C
G98	DTB133HK	ROHM	PNP	$V_{CB0}=-50B; I_C=-500mA; P_D=200mBт; h_{21}>56; f_T>200MГц; R1/R2=3.3/10kOM$	B	E	C
GC	2SC2734	HIT	NPN	$U_{CB0}=20B; I_C=50mA; P_D=150mBт; h_{21}>20...200; f_T>1.4ГГц$	B	E	C
GE	2SA1455KE	ROHM	PNP	$V_{CB0}=-120B; I_C=-50mA; P_D=200mBт; h_{21}=390...820; f_T>140MГц$	B	E	C
GR	2SA1455KR	ROHM	PNP	$V_{CB0}=-50B; I_C=-150mA; P_D=200mBт; h_{21}=180...390; f_T>140MГц$	B	E	C
GS	2SA1455KS	ROHM	PNP	$V_{CB0}=-50B; I_C=-150mA; P_D=200mBт; h_{21}=270...560; f_T>140MГц$	B	E	C

SOT346 (продолжение)

Код	Типономинал	Фирма	Функция	Особенности	Цоколевка		
					1	2	3
H02	DTC323TK	ROHM	NPN	$V_{CB0}=30B; I_C=600_{MA}; P_D=200_{MBT}; h_{21}=100...600; f_T>200_{MГц}; R_1=2.2_{кОм}$	B	E	C
H03	DTC343TK	ROHM	NPN	$V_{CB0}=30B; I_C=600_{MA}; P_D=200_{MBT}; h_{21}=100...600; f_T>200_{MГц}; R_1=4.7_{кОм}$	B	E	C
H04	DTC314TK	ROHM	NPN	$V_{CB0}=30B; I_C=600_{MA}; P_D=200_{MBT}; h_{21}=100...600; f_T>200_{MГц}; R_1=10_{кОм}$	B	E	C
H07	DTC363TK	ROHM	NPN	$V_{CB0}=30B; I_C=600_{MA}; P_D=200_{MBT}; h_{21}=100...600; f_T>200_{MГц}; R_1=6.8_{кОм}$	B	E	C
H27	DTC363EK	ROHM	NPN	$V_{CB0}=30B; I_C=600_{MA}; P_D=200_{MBT}; h_{21}>70; f_T>200_{MГц}; R_1/R_2=6.8/6.8_{кОм}$	B	E	C
H9	1SS344	TOSH	SHD	$V_R>20B; V_F(I_F=500_{MA})<0.55B; I_R(V_R=20B)<0.5_{мкА}; C_T<120_{пФ}$	A	nc	K
HC	2SC2733	HIT	NPN	$U_{CB0}=30B; I_C=50_{MA}; P_D=150_{MBT}; h_{21}>60; f_T>600_{MГц}$	B	E	C
HE	2SC3906KE	ROHM	NPN	$V_{CB0}=120B; I_C=50_{MA}; P_D=200_{MBT}; h_{21}=390...820; f_T>140_{MГц}$	B	E	C
HP	2SA1036KP	ROHM	PNP	$V_{CB0}=-40B; I_C=-500_{MA}; P_D=200_{MBT}; h_{21}=82...180; f_T>200_{MГц}$	B	E	C
HQ	2SA1036KQ	ROHM	PNP	$V_{CB0}=-40B; I_C=-500_{MA}; P_D=200_{MBT}; h_{21}=120...270; f_T>200_{MГц}$	B	E	C
HR	2SA1036KR	ROHM	PNP	$V_{CB0}=-40B; I_C=-500_{MA}; P_D=200_{MBT}; h_{21}=180...390; f_T>200_{MГц}$	B	E	C
HR	2SC3906KR	ROHM	NPN	$V_{CB0}=120B; I_C=50_{MA}; P_D=200_{MBT}; h_{21}=180...390; f_T>140_{MГц}$	B	E	C
HS	2SC3906KS	ROHM	NPN	$V_{CB0}=120B; I_C=50_{MA}; P_D=200_{MBT}; h_{21}=270...560; f_T>140_{MГц}$	B	E	C
I9	1SS336	TOSH	2xDI	$V_R<80B; I_F<200A; V_F(I_F=200_{MA})<1.2B; I_R<0.5_{мкА}; t_{RR}<20_{нс}$	K1	K2	A1 A2
ID-	2SC3127	HIT	NPN	$U_{CB0}=20B; I_C=50_{MA}; P_D=150_{MBT}; f_T>3.5_{ГГц}$	B	E	C
IE	2SC3722KE	ROHM	NPN	$V_{CB0}=120B; I_C=50_{MA}; P_D=200_{MBT}; h_{21}=390...820; f_T>140_{MГц}$	B	E	C
IG-	2SK360	HIT	nMOS	$U_{DS}=20B; I_D=30_{MA}; P_D=150_{MBT}; N_F=2.0_{дБ}$	D	G	S
IJ-	2SC3374	HIT	NPN	$U_{CB0}=20B; I_C=20_{MA}; P_D=150_{MBT}; h_{21}=20...200; f_T>400_{MГц}$	B	E	C
IL-	2SC3493	HIT	NPN	$U_{CB0}=15B; I_C=20_{MA}; P_D=150_{MBT}; h_{21}=30...200; f_T>700_{MГц}$	B	E	C
IP-	2SC3793	HIT	NPN	$U_{CB0}=20B; I_C=50_{MA}; P_D=150_{MBT}; h_{21}=50...200; f_T>1.4_{ГГц}$	B	E	C
IR	2SC3722KR	ROHM	NPN	$V_{CB0}=120B; I_C=50_{MA}; P_D=200_{MBT}; h_{21}=120...390; f_T>140_{MГц}$	B	E	C
IS	2SC3722KS	ROHM	NPN	$V_{CB0}=120B; I_C=50_{MA}; P_D=200_{MBT}; h_{21}=270...560; f_T>140_{MГц}$	B	E	C
IS-	2SC3513	HIT	NPN	$U_{CB0}=15B; I_C=50_{MA}; P_D=150_{MBT}; h_{21}=50...250; f_T>4.5_{ГГц}$	B	E	C
J9	1SS337	TOSH	2xDI	$V_R<80B; I_F<200A; V_F(I_F=200_{MA})<1.2B; I_R<0.5_{мкА}; t_{RR}<20_{нс}$	A1	A2	K1 K2
JC	2SC2735	HIT	NPN	$U_{CB0}=30B; I_C=50_{MA}; P_D=150_{MBT}; h_{21}>40; f_T>600_{MГц}$	E	B	C
JM	2SC2059KM	ROHM	NPN	$V_{CB0}=25B; I_C=20_{MA}; P_D=150_{MBT}; h_{21}=39...82; f_T>500_{MГц}$	B	E	C
JN	2SC2059KN	ROHM	NPN	$V_{CB0}=25B; I_C=20_{MA}; P_D=150_{MBT}; h_{21}=56...120; f_T>500_{MГц}$	B	E	C
JP	2SC2059KP	ROHM	NPN	$V_{CB0}=25B; I_C=20_{MA}; P_D=150_{MBT}; h_{21}=82...180; f_T>500_{MГц}$	B	E	C
K14	DTA114GKA	ROHM	PNP	$V_{CB0}=-50B; I_C=-100_{MA}; P_D=200_{MBT}; h_{21}>30; f_T>250_{MГц}; R_2=10_{кОм}$	B	E	C
K15	DTA124GKA	ROHM	PNP	$V_{CB0}=-50B; I_C=-100_{MA}; P_D=200_{MBT}; h_{21}>56; f_T>250_{MГц}; R_2=22_{кОм}$	B	E	C
K16	DTA144GKA	ROHM	PNP	$V_{CB0}=-50B; I_C=-100_{MA}; P_D=200_{MBT}; h_{21}>68; f_T>250_{MГц}; R_2=47_{кОм}$	B	E	C
K19	DTA115GKA	ROHM	PNP	$V_{CB0}=-50B; I_C=-100_{MA}; P_D=200_{MBT}; h_{21}>82; f_T>250_{MГц}; R_2=100_{кОм}$	B	E	C
K24	DTC114GKA	ROHM	PNP	$V_{CB0}=50B; I_C=100_{MA}; P_D=200_{MBT}; h_{21}>30; f_T>250_{MГц}; R_2=10_{кОм}$	B	E	C
K25	DTC124GKA	ROHM	PNP	$V_{CB0}=50B; I_C=100_{MA}; P_D=200_{MBT}; h_{21}>56; f_T>250_{MГц}; R_2=22_{кОм}$	B	E	C
K26	DTC144GKA	ROHM	PNP	$V_{CB0}=50B; I_C=100_{MA}; P_D=200_{MBT}; h_{21}>68; f_T>250_{MГц}; R_2=47_{кОм}$	B	E	C
K29	DTC115GKA	ROHM	PNP	$V_{CB0}=50B; I_C=100_{MA}; P_D=200_{MBT}; h_{21}>82; f_T>250_{MГц}; R_2=100_{кОм}$	B	E	C
K3B	DTA1D3RKA	ROHM	PNP	$V_{CB0}=-50B; I_C=-30_{MA}; P_D=200_{MBT}; h_{21}>20; f_T>250_{MГц}; R_1/R_2=2.7/1_{кОм}$	B	E	C
K4B	DTC1D3RKA	ROHM	PNP	$V_{CB0}=50B; I_C=30_{MA}; P_D=200_{MBT}; h_{21}>20; f_T>250_{MГц}; R_1/R_2=2.7/1_{кОм}$	B	E	C
K9	ISS348	TOSH	SHD	$V_R>80B; V_F(I_F=100_{MA})<0.7B; I_R(V_R=80B)<5_{мкА}; C_T<100_{пФ}$	A	nc	K
KE	2SK1062	TOSH	nMOS	$V_{DS}=60B; I_D=200_{MA}; P_D=200_{MBT}; R_{DS(on)}=0.6_{Ом}$	G	S	D
KF	2SJ168	TOSH	pMOS	$V_{DS}=-60B; I_D=-200_{MA}; P_D=200_{MBT}; R_{DS(on)}=1.3_{Ом}$	G	S	D
KH	2SK1826	TOSH	nMOS	$V_{DS}=50B; I_D=50_{MA}; P_D=200_{MBT}; R_{DS(on)}=20_{Ом}$	G	S	D
KI	2SK1828	TOSH	nMOS	$V_{DS}=20B; I_D=50_{MA}; P_D=100_{MBT}; R_{DS(on)}=20_{Ом}$	G	S	D
KJ	2SK2036	TOSH	nMOS	$V_{DS}=20B; I_D=100_{MA}; P_D=200_{MBT}; R_{DS(on)}=3.5_{Ом}$	G	S	D

SOT346 (продолжение)

Код	Типономинал	Фирма	Функция	Особенности	Цоколевка		
					1	2	3
KK	2SK2823	TOSH	nMOS	$V_{DS}=20B; I_D=100_{MA}; P_D=200_{MBT}; R_{DS(on)}=70_{OM};$	G	S	D
KM	2SK2009	TOSH	nMOS	$V_{DS}=30B; I_D=200_{MA}; P_D=200_{MBT}; R_{DS(on)}=1.20_{OM};$	G	S	D
KN	2SJ305	TOSH	pMOS	$V_{DS}=-30B; I_D=-200_{MA}; P_D=200_{MBT}; R_{DS(on)}=2.40_{OM};$	G	S	D
KP	2SK2033	TOSH	nMOS	$V_{DS}=20B; I_D=100_{MA}; P_D=200_{MBT}; R_{DS(on)}=80_{OM};$	G	S	D
KQ	2SJ343	TOSH	pMOS	$V_{DS}=-50B; I_D=-50_{MA}; P_D=200_{MBT}; R_{DS(on)}=20_{OM};$	G	S	D
KS	2SJ345	TOSH	pMOS	$V_{DS}=-20B; I_D=50_{MA}; P_D=200_{MBT}; R_{DS(on)}=20_{OM};$	G	S	D
L14	DTB114GK	ROHM	PNP	$V_{CB0}=-50B; I_C=-500_{MA}; P_D=200_{MBT}; h_{21}>56; f_T>200_{MГц}; R_2=10_{кОМ}$	B	E	C
L24	DTD114GK	ROHM	NPN	$V_{CB0}=50B; I_C=500_{MA}; P_D=200_{MBT}; h_{21}>56; f_T>200_{MГц}; R_2=10_{кОМ}$	B	E	C
L9	1SS349	TOSH	SHD	$V_R>20B; V_F(I_F=1A)<0.55B; I_R(V_R=20B)<50_{мкА}; C_T=250_{пФ}$	A	nc	K
LE	2SC2412KLNE	ROHM	NPN	$V_{CB0}=50B; I_C=150_{MA}; P_D=200_{MBT}; h_{21}=390...820; f_T>180_{MГц}$	B	E	C
LG	2SC2712GR	TOSH	NPN	$V_{CB0}=50B; I_C=150_{MA}; P_D=150_{MBT}; h_{21}=200...400; f_T>80_{MГц}$	B	E	C
LL	2SC2712BL	TOSH	NPN	$V_{CE0}=50B; I_C=150_{MA}; P_D=150_{MBT}; h_{21}=350...700; f_T>80_{MГц}$	B	E	C
LO	2SC2712O	TOSH	NPN	$V_{CE0}=50B; I_C=150_{MA}; P_D=150_{MBT}; h_{21}=70...140; f_T>80_{MГц}$	B	E	C
LR	2SC2412KLN	ROHM	NPN	$V_{CB0}=50B; I_C=150_{MA}; P_D=200_{MBT}; h_{21}=180...390; f_T>180_{MГц}$	B	E	C
LS	2SC2412KLNS	ROHM	NPN	$V_{CB0}=50B; I_C=150_{MA}; P_D=200_{MBT}; h_{21}=270...560; f_T>180_{MГц}$	B	E	C
LY	2SC2712Y	TOSH	NPN	$V_{CE0}=50B; I_C=150_{MA}; P_D=150_{MBT}; h_{21}=120...240; f_T>80_{MГц}$	B	E	C
N9	1SS379	TOSH	2xDI	$V_R>10B; V_F(I_F=100_{MA})<0.5B; I_R(V_R=10B)<20_{мкА}; C_T<40_{пФ}$	A1	K2	K1 K2
O9	1SS377	TOSH	2xDI	$V_R>10B; V_F(I_F=100_{MA})<0.5B; I_R(V_R=10B)<20_{мкА}; C_T<40_{пФ}$	A1	A2	K1 K2
P9	1SS379	TOSH	2xDI	$V_R<80B; I_F<100A; V_F(I_F=200_{MA})<1.3B; I_R<0.01_{мкА};$	A1	K2	K1 K2
QA	RN1421	TOSH	dNPN	$V_{CE0}=50B; I_C=800_{MA}; P_D=200_{MBT}; f_T>250_{MГц}; R_1/R_2=1/1_{кОМ}$	B	E	C
QB	RN1422	TOSH	dNPN	$V_{CE0}=50B; I_C=800_{MA}; P_D=200_{MBT}; f_T>250_{MГц}; R_1/R_2=2.2/2.2_{кОМ}$	B	E	C
QC	RN1423	TOSH	dNPN	$V_{CE0}=50B; I_C=800_{MA}; P_D=200_{MBT}; f_T>250_{MГц}; R_1/R_2=4.7/4.7_{кОМ}$	B	E	C
QD	RN1424	TOSH	dNPN	$V_{CE0}=50B; I_C=800_{MA}; P_D=200_{MBT}; f_T>250_{MГц}; R_1/R_2=10/10_{кОМ}$	B	E	C
QE	RN1425	TOSH	dNPN	$V_{CE0}=50B; I_C=800_{MA}; P_D=200_{MBT}; f_T>250_{MГц}; R_1/R_2=0.47/10_{кОМ}$	B	E	C
QF	RN1426	TOSH	dNPN	$V_{CE0}=50B; I_C=800_{MA}; P_D=200_{MBT}; f_T>250_{MГц}; R_1/R_2=1/10_{кОМ}$	B	E	C
QG	RN1427	TOSH	dNPN	$V_{CE0}=50B; I_C=800_{MA}; P_D=200_{MBT}; f_T>250_{MГц}; R_1/R_2=2.2/10_{кОМ}$	B	E	C
QI	2SC4196	HIT	NPN	$U_{CB0}=25B; I_C=50_{MA}; P_D=150_{MBT}; h_{21}=50...180; f_T>1.8_{ГГц}$	B	E	C
R1A	MMST3904	ROHM	NPN	$V_{CB0}=25B; I_C=50_{MA}; P_D=150_{MBT}; h_{21}=50...180; f_T>1.8_{ГГц}$	B	E	C
R1B	MMST2222	ROHM	NPN	$V_{CB0}=25B; I_C=50_{MA}; P_D=150_{MBT}; h_{21}=50...180; f_T>1.8_{ГГц}$	B	E	C
R1C	MMST1130	ROHM	NPN	$V_{CB0}=30B; I_C=200_{MA}; h_{21}=120...360;$	B	E	C
R1C	MMSTA20	ROHM	NPN	$V_{CB0}=40B; I_C=200_{MA}; h_{21}>120; f_T>125_{MГц}$	B	E	C
R1G	MMSTA06	ROHM	NPN	$V_{CB0}=80B; I_C=500_{MA}; h_{21}>100; f_T>100_{MГц}$	B	E	C
R1K	MMST6428	ROHM	NPN	$V_{CB0}=60B; I_C=200_{MA}; h_{21}=250...650; f_T>100_{MГц}$	B	E	C
R1M	MMSTA13	ROHM	NPN	$V_{CB0}=30B; I_C=500_{MA}; h_{21}>10000; f_T>125_{MГц}$	B	E	C
R1P	MMST2222A	ROHM	NPN	$V_{CB0}=75B; I_C=600_{MA}; h_{21}=100...300; f_T>250_{MГц}$	B	E	C
R1N	MMSTA14	ROHM	NPN	$V_{CB0}=30B; I_C=500_{MA}; h_{21}>20000; f_T>125_{MГц}$	B	E	C
R1O	MMST5088	ROHM	NPN	$V_{CB0}=35B; I_C=200_{MA}; h_{21}=300...900; f_T>50_{MГц}$	B	E	C
R1R	MMST5089	ROHM	NPN	$V_{CB0}=30B; I_C=200_{MA}; h_{21}=400...1200; f_T>50_{MГц}$	B	E	C
R2A	MMST3906	ROHM	PNP	$V_{CB0}=-40B; I_C=-200_{MA}; h_{21}=100...300; f_T>250_{MГц}$	B	E	C
R2B	MMST2907	ROHM	PNP	$V_{CB0}=-60B; I_C=-600_{MA}; h_{21}=100...300; f_T>200_{MГц}$	B	E	C
R2C	MMSTA70	ROHM	PNP	$V_{CB0}=-60B; I_C=-200_{MA}; h_{21}=160...400; f_T>125_{MГц}$	B	E	C
R2F	MMST2907A	ROHM	PNP	$V_{CB0}=-60B; I_C=-600_{MA}; h_{21}=100...300; f_T>200_{MГц}$	B	E	C
R2G	MMSTA56	ROHM	PNP	$V_{CB0}=-80B; I_C=-500_{MA}; h_{21}>100; f_T>50_{MГц}$	B	E	C
R2K	MMST8598	ROHM	PNP	$V_{CB0}=-60B; I_C=-200_{MA}; h_{21}=100...300; f_T>150_{MГц}$	B	E	C
R2P	MMST5086	ROHM	PNP	$V_{CB0}=-50B; I_C=-200_{MA}; h_{21}=150...500; f_T>40_{MГц}$	B	E	C
R2O	MMST5087	ROHM	PNP	$V_{CB0}=-50B; I_C=-200_{MA}; h_{21}=250...800; f_T>40_{MГц}$	B	E	C
R2Q	SST7157	ROHM	PNP	$V_{CB0}=-60B; I_C=-200_{MA}; h_{21}>100;$	B	E	C
R2T	MMST4403	ROHM	PNP	$V_{CB0}=-40B; I_C=-600_{MA}; h_{21}=100...300; f_T>200_{MГц}$	B	E	C
R2U	MMSTA63	ROHM	PNP	$V_{CB0}=-30B; I_C=-300_{MA}; h_{21}>5000; f_T>125_{MГц}$	B	E	C
R2V	MMSTA64	ROHM	PNP	$V_{CB0}=-30B; I_C=-300_{MA}; h_{21}>10000; f_T>125_{MГц}$	B	E	C
R2X	MMST4401	ROHM	PNP	$V_{CB0}=-60B; I_C=-600_{MA}; h_{21}=100...300; f_T>250_{MГц}$	B	E	C
R9	1SS392	TOSH	2xSHD	$V_R>40B; V_F(I_F=100_{MA})<0.6B; I_R(V_R=40B)<5_{мкА}; C_T<25_{пФ}$	A1	A2	K1 K2
R93	SSTTIS93	ROHM	PNP	$V_{CB0}=-40B; I_C=-800_{MA}; h_{21}=100...300; f_T>50_{MГц}$	B	E	C
RA	RN2421	TOSH	dPNP	$V_{CE0}=-50B; I_C=-800_{MA}; P_D=200_{MBT}; f_T>250_{MГц}; R_1/R_2=1/1_{кОМ}$	B	E	C
RAT	MMST28	ROHM	NPN	$V_{CB0}=80B; I_C=500_{MA}; h_{21}>10000; f_T>125_{MГц}$	B	E	C
RB	RN2422	TOSH	dPNP	$V_{CE0}=-50B; I_C=-800_{MA}; P_D=200_{MBT}; f_T>250_{MГц}; R_1/R_2=2.2/2.2_{кОМ}$	B	E	C
RBR	MMST6838	ROHM	NPN	$V_{CB0}=50B; I_C=200_{MA}; h_{21}>200; f_T>50_{MГц}$	B	E	C

SOT346 (продолжение)

Код	Типоминал	Фирма	Функция	Особенности	Цоколевка		
					1	2	3
RC	RN2423	TOSH	dPNP	$V_{CE0}=-50B; I_C=-800mA; P_D=200mBт; f_T>250MГц; R1/R2=4.7/4.7kOM$	B	E	C
RD	RN2424	TOSH	dPNP	$V_{CE0}=-50B; I_C=-800mA; P_D=200mBт; f_T>250MГц; R1/R2=10/10kOM$	B	E	C
RE	2SA1514KE	ROHM	PNP	$V_{CE0}=-120B; I_C=-50mA; P_D=200mBт; h_{21}=390...820; f_T>140MГц$	B	E	C
RE	RN2425	TOSH	dPNP	$V_{CE0}=-50B; I_C=-800mA; P_D=200mBт; f_T>250MГц; R1/R2=0.47/10kOM$	B	E	C
RF	RN2426	TOSH	dPNP	$V_{CE0}=-50B; I_C=-800mA; P_D=200mBт; f_T>250MГц; R1/R2=1/10kOM$	B	E	C
RFQ	SST6839	ROHM	PNP	$V_{CB0}=-50B; I_C=-200mA; h_{21}>100; f_T>50MГц$	B	E	C
RG	RN2427	TOSH	dPNP	$V_{CE0}=-50B; I_C=-800mA; P_D=200mBт; f_T>250MГц; R1/R2=2.2/10kOM$	B	E	C
RR	2SA1514KR	ROHM	PNP	$V_{CE0}=-120B; I_C=-50mA; P_D=200mBт; h_{21}=180...390; f_T>140MГц$	B	E	C
RS	2SA1514KS	ROHM	PNP	$V_{CE0}=-120B; I_C=-50mA; P_D=200mBт; h_{21}=270...560; f_T>140MГц$	B	E	C
RVZ	MMST4126	ROHM	PNP	$V_{CB0}=-25B; I_C=-200mA; h_{21}=120...360; f_T>250MГц$	B	E	C
RZC	MMST4124	ROHM	NPN	$V_{CB0}=30B; I_C=200mA; h_{21}=120...360; f_T>300MГц$	B	E	C
S9	1SS394	TOSH	SHD	$V_R>10B; V_F(I_F=100mA)<0.5B; I_R(V_R=10B)<20mA; C_T<40пФ$	A	nc	K
SM	2SC3082KM	ROHM	NPN	$V_{CB0}=30B; I_C=50mA; P_D=200mBт; h_{21}=39...82; f_T>110MГц$	B	E	C
SN	2SC3082KN	ROHM	NPN	$V_{CB0}=30B; I_C=50mA; P_D=200mBт; h_{21}=56...120; f_T>110MГц$	B	E	C
SP	2SC3082KP	ROHM	NPN	$V_{CB0}=30B; I_C=50mA; P_D=200mBт; h_{21}=82...180; f_T>110MГц$	B	E	C
SQ	2SC3082KQ	ROHM	NPN	$V_{CB0}=30B; I_C=50mA; P_D=200mBт; h_{21}=120...270; f_T>110MГц$	B	E	C
T9	1SS396	TOSH	2xSHD	$V_R>40B; V_F(I_F=100mA)<0.6B; I_R(V_R=40B)<5mA; C_T<25пФ$	A1	K2	K1 A2
TC	2SC2736	HIT	NPN	$U_{CB0}=30B; I_C=50mA; P_D=150mBт; h_{21}=30...200; f_T>1.4ГГц$	B	E	C
TE	2SC33906KE	ROHM	NPN	$V_{CB0}=120B; I_C=50mA; P_D=200mBт; h_{21}=390...820; f_T>140MГц$	B	E	C
TI-	2SC4197	HIT	NPN	$U_{CB0}=25B; I_C=50mA; P_D=150mBт; h_{21}=30...200; f_T>1.4ГГц$	B	E	C
TR	2SC33906KR	ROHM	NPN	$V_{CB0}=120B; I_C=50mA; P_D=200mBт; h_{21}=390...820; f_T>140MГц$	B	E	C
TS	2SC33906KS	ROHM	NPN	$U_{CB0}=25B; I_C=50mA; P_D=150mBт; h_{21}=50...180; f_T>3ГГц$	B	E	C
UA	2SB852KA	ROHM	PNP	$V_{CB0}=-40B; I_C=-300mA; P_D=200mBт; h_{21}>1000; f_T>200MГц$	B	E	C
UB	2SB852KB	ROHM	PNP	$V_{CB0}=-40B; I_C=-300mA; P_D=200mBт; h_{21}>5000; f_T>200MГц$	B	E	C
UI-	2SC4229	HIT	NPN	$U_{CB0}=30B; I_C=20mA; P_D=150mBт; h_{21}=50...180; f_T>700MГц$	B	E	C
WA	2SD1383KA	ROHM	NPN	$V_{CB0}=40B; I_C=300mA; P_D=300mBт; h_{21}>1000; f_T>250MГц$	B	E	C
WB	2SD1383KB	ROHM	NPN	$V_{CB0}=40B; I_C=300mA; P_D=200mBт; h_{21}>5000; f_T>250MГц$	B	E	C
X	2SB1051K	ROHM	PNP	$V_{CB0}=32B; I_C=-1000mA; P_D=200mBт; h_{21}=390; f_T>150MГц$	B	E	C
X9	ISS398	TOSH	2xDI	$V_R>400B; I_F<100mA; V_F(I_F=100mA)<1.3B; I_R<1.0mA;$	A1	K2	K1 A2
XA	RN1401	TOSH	dNPN	$V_{CE0}=50B; I_C=100mA; P_D=200mBт; f_T=200MГц; R1/R2=4.7/4.7kOM$	B	E	C
XB	RN1402	TOSH	dNPN	$V_{CE0}=50B; I_C=100mA; P_D=200mBт; f_T>250MГц; R1/R2=10/10kOM$	B	E	C
XB	2SC4416	HIT	NPN	$U_{CB0}=25B; I_C=50mA; P_D=150mBт; h_{21}=50...180; f_T>3ГГц$	E	B	C
XC	RN1403	TOSH	dNPN	$V_{CE0}=50B; I_C=100mA; P_D=200mBт; f_T=200MГц; R1/R2=22/22kOM$	B	E	C
XD	RN1404	TOSH	dNPN	$V_{CE0}=50B; I_C=100mA; P_D=200mBт; f_T=200MГц; R1/R2=47/47kOM$	B	E	C
XE	RN1405	TOSH	dNPN	$V_{CE0}=50B; I_C=100mA; P_D=200mBт; f_T=200MГц; R1/R2=2.2/47kOM$	B	E	C
XF	RN1406	TOSH	dNPN	$V_{CE0}=50B; I_C=100mA; P_D=200mBт; f_T=200MГц; R1/R2=4.7/4.7kOM$	B	E	C
XH	RN1407	TOSH	dNPN	$V_{CE0}=50B; I_C=100mA; P_D=200mBт; f_T=200MГц; R1/R2=10/47kOM$	B	E	C
XI	RN1408	TOSH	dNPN	$V_{CE0}=50B; I_C=100mA; P_D=200mBт; f_T=200MГц; R1/R2=22/47kOM$	B	E	C
XJ	RN1409	TOSH	dNPN	$V_{CE0}=50B; I_C=100mA; P_D=200mBт; f_T=200MГц; R1/R2=47/22kOM$	B	E	C
XK	RN1410	TOSH	dNPN	$V_{CE0}=50B; I_C=100mA; P_D=200mBт; f_T=200MГц; R1=4.7kOM$	B	E	C
XM	RN1411	TOSH	dNPN	$V_{CE0}=50B; I_C=100mA; P_D=200mBт; f_T=200MГц; R1=10kOM$	B	E	C
XM	2SC4591	HIT	NPN	$U_{CB0}=15B; I_C=50mA; P_D=150mBт; h_{21}=40...250; f_T>6.5ГГц$	B	E	C
XN	RN1412	TOSH	dNPN	$V_{CE0}=50B; I_C=100mA; P_D=200mBт; f_T=200MГц; R1=22kOM$	B	E	C
XP	RN1413	TOSH	dNPN	$V_{CE0}=50B; I_C=100mA; P_D=200mBт; f_T=200MГц; R1=47kOM$	B	E	C
XQ	RN1414	TOSH	dNPN	$V_{CE0}=50B; I_C=100mA; P_D=200mBт; f_T=200MГц; R1/R2=1/10kOM$	B	E	C
XS	RN1415	TOSH	dNPN	$V_{CE0}=50B; I_C=100mA; P_D=200mBт; f_T=200MГц; R1/R2=2.2/10kOM$	B	E	C
XT	RN1416	TOSH	dNPN	$V_{CE0}=50B; I_C=100mA; P_D=200mBт; f_T=200MГц; R1/R2=4.7/10kOM$	B	E	C
XU	RN1417	TOSH	dNPN	$V_{CE0}=50B; I_C=100mA; P_D=200mBт; f_T=200MГц; R1/R2=10/4.7kOM$	B	E	C
XU	2SC4680	HIT	NPN	$U_{CB0}=12B; I_C=50mA; P_D=150mBт; h_{21}>100$	B	E	C
XW	RN1418	TOSH	dNPN	$V_{CE0}=50B; I_C=100mA; P_D=200mBт; f_T=200MГц; R1/R2=47/10kOM$	B	E	C
YA	RN2401	TOSH	dNPN	$V_{CE0}=-50B; I_C=-100mA; P_D=200mBт; f_T=200MГц; R1/R2=4.7/4.7kOM$	B	E	C
YB	RN2402	TOSH	dPNP	$V_{CE0}=-50B; I_C=-100mA; P_D=200mBт; f_T=200MГц; R1/R2=10/10kOM$	B	E	C
YC	RN2403	TOSH	dPNP	$V_{CE0}=-50B; I_C=-100mA; P_D=200mBт; f_T=200MГц; R1/R2=22/22kOM$	B	E	C
YD	RN2404	TOSH	dPNP	$V_{CE0}=-50B; I_C=-100mA; P_D=200mBт; f_T=200MГц; R1/R2=47/47kOM$	B	E	C

SOT346 (продолжение)

Код	Типоминал	Фирма	Функция	Особенности	Цоколевка		
					1	2	3
YE	RN2405	TOSH	dPNP	$V_{CE0}=-50B; I_C=-100mA; P_D=200mBт; f_T=200MГц; R1/R2=2.2/47kOM$	B	E	C
YF	RN2406	TOSH	dPNP	$V_{CE0}=-50B; I_C=-100mA; P_D=200mBт; f_T=200MГц; R1/R2=4.7/47kOM$	B	E	C
YH	RN2407	TOSH	dPNP	$V_{CE0}=-50B; I_C=-100mA; P_D=200mBт; f_T=200MГц; R1/R2=10/47kOM$	B	E	C
YI	RN2408	TOSH	dPNP	$V_{CE0}=-50B; I_C=-100mA; P_D=200mBт; f_T=200MГц; R1/R2=22/47kOM$	B	E	C
YJ	RN2409	TOSH	dPNP	$V_{CE0}=-50B; I_C=-100mA; P_D=200mBт; f_T=200MГц; R1/R2=47/22kOM$	B	E	C
YK	RN2410	TOSH	dPNP	$V_{CE0}=-50B; I_C=-100mA; P_D=200mBт; f_T=20MГц; R1=4.7kOM$	B	E	C
YM	RN2411	TOSH	dPNP	$V_{CE0}=-50B; I_C=-100mA; P_D=200mBт; f_T=20MГц; R1=10kOM$	B	E	C
YN	RN2412	TOSH	dPNP	$V_{CE0}=-50B; I_C=-100mA; P_D=200mBт; f_T=20MГц; R1=22kOM$	B	E	C
YP	2SD1484KP	ROHM	NPN	$V_{CB0}=50B; I_C=500mA; P_D=200mBт; h_{21}=82...180; f_T>250MГц$	B	E	C
YP	RN2413	TOSH	dPNP	$V_{CE0}=-50B; I_C=-100mA; P_D=200mBт; f_T=20MГц; R1=47kOM$	B	E	C
YQ	2SD1484KQ	ROHM	NPN	$V_{CB0}=50B; I_C=500mA; P_D=200mBт; h_{21}=120...270; f_T>250MГц$	B	E	C
YQ	RN2414	TOSH	dPNP	$V_{CE0}=-50B; I_C=-100mA; P_D=200mBт; f_T=200MГц; R1/R2=1/10kOM$	B	E	C
YR	2SD1484KR	TOSH	NPN	$V_{CB0}=50B; I_C=500mA; P_D=200mBт; h_{21}=180...390; f_T>250MГц$	B	E	C
YS	RN2415	TOSH	dPNP	$V_{CE0}=-50B; I_C=-100mA; P_D=200mBт; f_T=200MГц; R1/R2=2.2/10kOM$	B	E	C
YT	RN2416	TOSH	dPNP	$V_{CE0}=-50B; I_C=-100mA; P_D=200mBт; f_T=200MГц; R1/R2=4.7/10kOM$	B	E	C
YU	RN2417	TOSH	dPNP	$V_{CE0}=-50B; I_C=-100mA; P_D=200mBт; f_T=200MГц; R1/R2=10/4.7kOM$	B	E	C
YW	RN2418	TOSH	dPNP	$V_{CE0}=-50B; I_C=-100mA; P_D=200mBт; f_T=200MГц; R1/R2=47/10kOM$	B	E	C

SOT – 416
SC – 75A

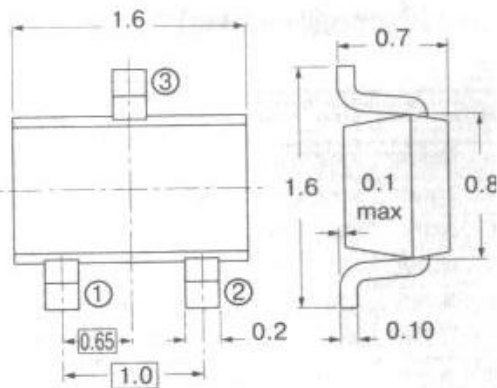

Код	Типономинал	Фирма	Функция	Особенности	Цоколевка		
					1	2	3
03	DTC143TE	ROHM	D-NPN	$V_{CB0}=50B; I_C=100mA; P_D=150mBT; h_{21}=100...600; f_T>250MГц$ $R1=4.7kOm$	B	E	C
04	DTC114TE	ROHM	D-NPN	$V_{CB0}=50B; I_C=100mA; P_D=150mBT; h_{21}=100...600; f_T>250MГц$ $R1=10kOm$	B	E	C
05	DTC124TE	ROHM	D-NPN	$V_{CB0}=50B; I_C=100mA; P_D=150mBT; h_{21}=100...600; f_T>250MГц$ $R1=22kOm$	B	E	C
06	DTC144TE	ROHM	D-NPN	$V_{CB0}=50B; I_C=100mA; P_D=150mBT; h_{21}=100...600; f_T>250MГц$ $R1=47kOm$	B	E	C
12	DTA123EE	ROHM	D-NPN	$V_{CB0}=50B; I_C=100mA; P_D=150mBT; h_{21}>20; f_T>250MГц$ $R1/R2=2.2/2.2kOm$	B	E	C
13	DTA143EE	ROHM	D-NPN	$V_{CB0}=50B; I_C=100mA; P_D=150mBT; h_{21}>20; f_T>250MГц$ $R1/R2=4.7/4.7kOm$	B	E	C
14	DTA114EE	ROHM	D-NPN	$V_{CB0}=50B; I_C=100mA; P_D=150mBT; h_{21}>30; f_T>250MГц$ $R1/R2=10/10kOm$	B	E	C
15	DTA124EE	ROHM	D-NPN	$V_{CB0}=50B; I_{C(max)}=100mA; P_D=150mBT; h_{21}>56; f_T>250MГц$ $R1/R2=22/22kOm$	B	E	C
16	DTA144EE	ROHM	D-NPN	$V_{CB0}=50B; I_{C(max)}=100mA; P_D=150mBT; h_{21}>68; f_T>250MГц$ $R1/R2=47/47kOm$	B	E	C
19	DTA115EE	ROHM	D-NPN	$V_{CB0}=50B; I_{C(max)}=100mA; P_D=150mBT; h_{21}>82; f_T>250MГц$ $R1/R2=100/100kOm$	B	E	C
22	DTC123EE	ROHM	D-NPN	$V_{CB0}=50B; I_C=100mA; P_D=150mBT; h_{21}>20; f_T>250MГц$ $R1/R2=2.2/2.2kOm$	B	E	C
23	DTC143EE	ROHM	D-NPN	$V_{CB0}=50B; I_C=100mA; P_D=150mBT; h_{21}>20; f_T>250MГц$ $R1/R2=4.7/4.7kOm$	B	E	C
24	DTC114EE	ROHM	D-NPN	$V_{CB0}=50B; I_C=100mA; P_D=150mBT; h_{21}>30; f_T>250MГц$ $R1/R2=10/10kOm$	B	E	C
25	DTC124EE	ROHM	D-NPN	$V_{CB0}=50B; I_{C(max)}=100mA; P_D=150mBT; h_{21}>56; f_T>250MГц$ $R1/R2=22/22kOm$	B	E	C
26	DTC144EE	ROHM	D-NPN	$V_{CB0}=50B; I_{C(max)}=100mA; P_D=150mBT; h_{21}>68; f_T>250MГц$ $R1/R2=47/47kOm$	B	E	C
29	DTC115EE	ROHM	D-NPN	$V_{CB0}=50B; I_{C(max)}=100mA; P_D=150mBT; h_{21}>82; f_T>250MГц$ $R1/R2=100/100kOm$	B	E	C
33	DTA143XE	ROHM	D-NPN	$V_{CB0}=50B; I_C=100mA; P_D=150mBT; h_{21}>20; f_T>250MГц$ $R1/R2=4.7/4.7kOm$	B	E	C
35	DTA124XE	ROHM	D-NPN	$V_{CB0}=50B; I_C=100mA; P_D=150mBT; h_{21}>68; f_T>250MГц$ $R1/R2=22/47kOm$	B	E	C
43	DTC143XE	ROHM	D-NPN	$V_{CB0}=50B; I_C=100mA; P_D=150mBT; h_{21}>30; f_T>250MГц$ $R1/R2=4.7/10kOm$	B	E	C
45	DTA124XE	ROHM	D-NPN	$V_{CB0}=50B; I_C=100mA; P_D=150mBT; h_{21}>68; f_T>250MГц$ $R1/R2=22/47kOm$	B	E	C
52	DTA123YE	ROHM	D-NPN	$V_{CB0}=50B; I_C=100mA; P_D=150mBT; h_{21}>33; f_T>250MГц$ $R1/R2=2.2/10kOm$	B	E	C
54	DTA114YE	ROHM	D-NPN	$V_{CB0}=50B; I_C=100mA; P_D=150mBT; h_{21}>68; f_T>250MГц$ $R1/R2=10/47kOm$	B	E	C
62	DTC123YE	ROHM	D-NPN	$V_{CB0}=50B; I_C=100mA; P_D=150mBT; h_{21}>33; f_T>250MГц$ $R1/R2=2.2/10kOm$	B	E	C
64	DTC114YE	ROHM	D-NPN	$V_{CB0}=50B; I_C=100mA; P_D=150mBT; h_{21}>68; f_T>250MГц$ $R1/R2=10/47kOm$	B	E	C
69	DTC115TE	ROHM	D-NPN	$V_{CB0}=50B; I_C=100mA; P_D=150mBT; h_{21}=100...600; f_T>250MГц$ $R1=100kOm$	B	E	C
74	DTA114WE	ROHM	D-NPN	$V_{CB0}=50B; I_C=100mA; P_D=150mBT; h_{21}>24; f_T>250MГц$ $R1/R2=10/4.7kOm$	B	E	C
76	DTA144WE	ROHM	D-NPN	$V_{CB0}=50B; I_{C(max)}=100mA; P_D=150mBT; h_{21}>56; f_T>250MГц$ $R1/R2=47/22kOm$	B	E	C
84	DTC114WE	ROHM	D-NPN	$V_{CB0}=50B; I_C=100mA; P_D=150mBT; h_{21}>24; f_T>250MГц$ $R1/R2=10/4.7kOm$	B	E	C

SOT – 416 (продолжение)

Код	Типоминал	Фирма	Функция	Особенности	Цоколевка		
					1	2	3
86	DTC144WE	ROHM	D-NPN	$V_{CB0}=50B; I_{C(max)}=100mA; P_D=150mBт; h_{21}>56; f_T>250MГц$ $R1/R2=47/22kOM$	B	E	C
93	DTA143TE	ROHM	D-NPN	$V_{CB0}=50B; I_C=100mA; P_D=150mBт; h_{21}=100...600; f_T>250MГц$ $R1=4.7kOM$	B	E	C
94	DTA114TE	ROHM	D-NPN	$V_{CB0}=50B; I_C=100mA; P_D=150mBт; h_{21}=100...600; f_T>250MГц$ $R1=10kOM$	B	E	C
95	DTA124TE	ROHM	D-NPN	$V_{CB0}=50B; I_C=100mA; P_D=150mBт; h_{21}=100...600; f_T>250MГц$ $R1=22kOM$	B	E	C
96	DTA144TE	ROHM	D-NPN	$V_{CB0}=50B; I_C=100mA; P_D=150mBт; h_{21}=100...600; f_T>250MГц$ $R1=47kOM$	B	E	C
99	DTA115TE	ROHM	D-NPN	$V_{CB0}=50B; I_C=100mA; P_D=150mBт; h_{21}=100...600; f_T>250MГц$ $R1=100kOM$	B	E	C
A3	ISS360	TOSH	2xDI	$V_R<80B; I_F<100A; V_F(I_F=100mA)<1.2B; I_R<0.5mA; t_{RR}<4нс$	K1	K2	A1 A2
AN	2SC4618	ROHM	NPN	$V_{CB0}=40B; I_C=50mA; P_D=150mBт; h_{21}=56...120; f_T>300MГц$	B	E	C
AP	2SC4618	ROHM	NPN	$V_{CB0}=40B; I_C=50mA; P_D=150mBт; h_{21}=82...180; f_T>300MГц$	B	E	C
AQ	2SC4618	ROHM	NPN	$V_{CB0}=40B; I_C=50mA; P_D=150mBт; h_{21}=120...270; f_T>300MГц$	B	E	C
B3	ISS361	TOSH	2xDI	$V_R<80B; I_F<100A; V_F(I_F=100mA)<1.2B; I_R<0.5mA; t_{RR}<4нс$	A1	A2	K1 K2
BQ	2SC4617	ROHM	NPN	$V_{CB0}=50B; I_C=150mA; P_D=200mBт; h_{21}=120...270;$ $f_T>180MГц$	B	E	C
BR	2SC4617	ROHM	NPN	$V_{CB0}=50B; I_C=150mA; P_D=200mBт; h_{21}=180...390;$ $f_T>180MГц$	B	E	C
BS	2SC4617	ROHM	NPN	$V_{CB0}=50B; I_C=150mA; P_D=200mBт; h_{21}=270...560;$ $f_T>180MГц$	B	E	C
C3	ISS362	TOSH	2xDI	$V_R<80B; I_F<80A; V_F(I_F=80mA)<1.2B; I_R<0.5mA; t_{RR}<4нс$	A1	K2	K1 A2
E11	DTA113ZE	ROHM	D-PNP	$V_{CB0}=50B; I_C=100mA; P_D=150mBт; h_{21}>33; f_T>250MГц$ $R1/R2=1/10kOM$	B	E	C
E13	DTA143ZE	ROHM	D-PNP	$V_{CB0}=50B; I_C=100mA; P_D=150mBт; h_{21}>80; f_T>250MГц$ $R1/R2=4.7/4.7kOM$	B	E	C
E21	DTC113ZE	ROHM	D-NPN	$V_{CB0}=50B; I_C=100mA; P_D=150mBт; h_{21}>33; f_T>250MГц$ $R1/R2=1/10kOM$	B	E	C
E23	DTC143ZE	ROHM	D-NPN	$V_{CB0}=50B; I_C=100mA; P_D=150mBт; h_{21}>80; f_T>250MГц$ $R1/R2=4.7/4.7kOM$	B	E	C
E32	DTA123JE	ROHM	D-PNP	$V_{CB0}=50B; I_C=100mA; P_D=150mBт; h_{21}>80; f_T>250MГц$ $R1/R2=2.2/47kOM$	B	E	C
E42	DTC123JE	ROHM	D-NPN	$V_{CB0}=50B; I_C=100mA; P_D=150mBт; h_{21}>80; f_T>250MГц$ $R1/R2=2.2/47kOM$	B	E	C
E56	DTA144VE	ROHM	D-PNP	$V_{CB0}=50B; I_C=100mA; P_D=150mBт; h_{21}>33; f_T>250MГц$ $R1/R2=47/10kOM$	B	E	C
E66	DTC144VE	ROHM	D-NPN	$V_{CB0}=50B; I_C=100mA; P_D=150mBт; h_{21}>33; f_T>250MГц$ $R1/R2=47/10kOM$	B	E	C
FQ	2SA177A	ROHM	PNP	$V_{CB0}=50B; I_C=150mA; P_D=200mBт; h_{21}=120...270;$ $f_T>140MГц$	B	E	C
FR	2SA177A	ROHM	PNP	$V_{CB0}=50B; I_C=150mA; P_D=200mBт; h_{21}=180...390;$ $f_T>140MГц$	B	E	C
FS	2SA177A	ROHM	PNP	$V_{CB0}=50B; I_C=150mA; P_D=200mBт; h_{21}=270...560;$ $f_T>140MГц$	B	E	C
JM	2SC4649	ROHM	NPN	$V_{CB0}=25B; I_C=20mA; P_D=150mBт; h_{21}=39...82; f_T>500MГц$	B	E	C
JN	2SC4649	ROHM	NPN	$V_{CB0}=25B; I_C=20mA; P_D=150mBт; h_{21}=56...120; f_T>500MГц$	B	E	C
JP	2SC4649	ROHM	NPN	$V_{CB0}=25B; I_C=20mA; P_D=150mBт; h_{21}=82...180; f_T>500MГц$	B	E	C
K19	DTA115GE	ROHM	D-PNP	$V_{CB0}=50B; I_C=100mA; P_D=150mBт; h_{21}>82; f_T>250MГц$ $R2=100kOM$	B	E	C
K29	DTC115GE	ROHM	D-NPN	$V_{CB0}=50B; I_C=100mA; P_D=150mBт; h_{21}>82; f_T>250MГц$ $R2=100kOM$	B	E	C
K3B	DTA1D3RE	ROHM	D-PNP	$V_{CB0}=50B; I_{C(max)}=100mA; P_D=150mBт; h_{21}>20; f_T>250MГц$	B	E	C
K4B	DTA1D3RE	ROHM	D-NPN	$V_{CB0}=50B; I_{C(max)}=100mA; P_D=150mBт; h_{21}>20; f_T>250MГц$	B	E	C
KI	2SK1830	TOSH	nFET	$V_{DS}=20B; I_C=50mA; P_D=200mBт; R_{DS(on)}=20OM$	G	S	D
KK	2SK2825	TOSH	nFET	$V_{DS}=20B; I_C=100mA; P_D=200mBт; R_{DS(on)}=10OM$	G	S	D
KP	2SK2035	TOSH	nFET	$V_{DS}=20B; I_C=100mA; P_D=200mBт; R_{DS(on)}=8OM$	G	S	D
KS	2SJ347	TOSH	pFET	$V_{DS}=-20B; I_C=-50mA; P_D=200mBт; R_{DS(on)}=20OM$	G	S	D
09	ISS385	TOSH	2xSHD	$V_R>10B; V_F(I_F=100mA)<0.5B; I_R(V_R=10B)<20mA;$ $C_T<20пФ$	A1	A2	K1 K2
SM	2SC4619	ROHM	NPN	$V_{CB0}=30B; I_C=50mA; P_D=150mBт; h_{21}=39...82; f_T>110MГц$	B	E	C
SN	2SC4619	ROHM	NPN	$V_{CB0}=30B; I_C=50mA; P_D=150mBт; h_{21}=56...120; f_T>110MГц$	B	E	C
SP	2SC4619	ROHM	NPN	$V_{CB0}=30B; I_C=50mA; P_D=150mBт; h_{21}=82...180; f_T>110MГц$	B	E	C
SQ	2SC4619	ROHM	NPN	$V_{CB0}=30B; I_C=50mA; P_D=150mBт; h_{21}=120...270; f_T>110MГц$	B	E	C
XA	RN1101	TOSH	D-NPN	$V_{CE0}=50B; I_C=150mA; P_D=100mBт; f_T>250MГц;$ $R1/R2=4.7/4.7kOM$	B	E	C

SOT – 416 (продолжение)

Код	Типоминал	Фирма	Функция	Особенности	Цоколевка		
					1	2	3
XB	RN1102	TOSH	D-NPN	$V_{CE0}=50B; I_C=150_{MA}; P_D=100_{mBT}; f_T>250_{MГц}; R1/R2=10/10_{кОм}$	B	E	C
XC	RN1103	TOSH	D-NPN	$V_{CE0}=50B; I_C=150_{MA}; P_D=100_{mBT}; f_T>250_{MГц}; R1/R2=22/22_{кОм}$	B	E	C
XD	RN1104	TOSH	D-NPN	$V_{CE0}=50B; I_C=150_{MA}; P_D=100_{mBT}; f_T>250_{MГц}; R1/R2=47/47_{кОм}$	B	E	C
XE	RN1105	TOSH	D-NPN	$V_{CE0}=50B; I_C=150_{MA}; P_D=100_{mBT}; f_T>250_{MГц}; R1/R2=2.2/47_{кОм}$	B	E	C
XF	RN1106	TOSH	D-NPN	$V_{CE0}=50B; I_C=150_{MA}; P_D=100_{mBT}; f_T>250_{MГц}; R1/R2=4.7/4.7_{кОм}$	B	E	C
XH	RN1107	TOSH	D-NPN	$V_{CE0}=50B; I_C=150_{MA}; P_D=100_{mBT}; f_T>250_{MГц}; R1/R2=10/47_{кОм}$	B	E	C
XI	RN1108	TOSH	D-NPN	$V_{CE0}=50B; I_C=150_{MA}; P_D=100_{mBT}; f_T>250_{MГц}; R1/R2=22/47_{кОм}$	B	E	C
XJ	RN1109	TOSH	D-NPN	$V_{CE0}=50B; I_C=150_{MA}; P_D=100_{mBT}; f_T>250_{MГц}; R1/R2=47/22_{кОм}$	B	E	C
XK	RN1110	TOSH	D-NPN	$V_{CE0}=50B; I_C=150_{MA}; P_D=100_{mBT}; f_T>250_{MГц}; R1=4.7_{кОм}$	B	E	C
XM	RN1111	TOSH	D-NPN	$V_{CE0}=50B; I_C=150_{MA}; P_D=100_{mBT}; f_T>250_{MГц}; R1=10_{кОм}$	B	E	C
XN	RN1112	TOSH	D-NPN	$V_{CE0}=50B; I_C=150_{MA}; P_D=100_{mBT}; f_T>250_{MГц}; R1=22_{кОм}$	B	E	C
XP	RN1113	TOSH	D-NPN	$V_{CE0}=50B; I_C=150_{MA}; P_D=100_{mBT}; f_T>250_{MГц}; R1=47_{кОм}$	B	E	C
XQ	RN1114	TOSH	D-NPN	$V_{CE0}=50B; I_C=150_{MA}; P_D=100_{mBT}; f_T>250_{MГц}; R1/R2=1/10_{кОм}$	B	E	C
XS	RN1115	TOSH	D-NPN	$V_{CE0}=50B; I_C=150_{MA}; P_D=100_{mBT}; f_T>250_{MГц}; R1/R2=2.2/10_{кОм}$	B	E	C
XT	RN1116	TOSH	D-NPN	$V_{CE0}=50B; I_C=150_{MA}; P_D=100_{mBT}; f_T>250_{MГц}; R1/R2=4.7/10_{кОм}$	B	E	C
XU	RN1117	TOSH	D-NPN	$V_{CE0}=50B; I_C=150_{MA}; P_D=100_{mBT}; f_T>250_{MГц}; R1/R2=10/4.7_{кОм}$	B	E	C
XW	RN1118	TOSH	D-NPN	$V_{CE0}=50B; I_C=150_{MA}; P_D=100_{mBT}; f_T>250_{MГц}; R1/R2=47/10_{кОм}$	B	E	C
YA	RN2101	TOSH	D-NPN	$V_{CE0}=50B; I_C=150_{MA}; P_D=100_{mBT}; f_T>250_{MГц}; R1/R2=4.7/4.7_{кОм}$	B	E	C
YB	RN2102	TOSH	D-NPN	$V_{CE0}=50B; I_C=150_{MA}; P_D=100_{mBT}; f_T>250_{MГц}; R1/R2=10/10_{кОм}$	B	E	C
YC	RN2103	TOSH	D-NPN	$V_{CE0}=50B; I_C=150_{MA}; P_D=100_{mBT}; f_T>250_{MГц}; R1/R2=22/22_{кОм}$	B	E	C
YD	RN2104	TOSH	D-NPN	$V_{CE0}=50B; I_C=150_{MA}; P_D=100_{mBT}; f_T>250_{MГц}; R1/R2=47/47_{кОм}$	B	E	C
YE	RN2105	TOSH	D-NPN	$V_{CE0}=50B; I_C=150_{MA}; P_D=100_{mBT}; f_T>250_{MГц}; R1/R2=2.2/47_{кОм}$	B	E	C
YF	RN2106	TOSH	D-NPN	$V_{CE0}=50B; I_C=150_{MA}; P_D=100_{mBT}; f_T>250_{MГц}; R1/R2=4.7/4.7_{кОм}$	B	E	C
YH	RN2107	TOSH	D-NPN	$V_{CE0}=50B; I_C=150_{MA}; P_D=100_{mBT}; f_T>250_{MГц}; R1/R2=10/47_{кОм}$	B	E	C
YI	RN2108	TOSH	D-NPN	$V_{CE0}=50B; I_C=150_{MA}; P_D=100_{mBT}; f_T>250_{MГц}; R1/R2=22/47_{кОм}$	B	E	C
YJ	RN2109	TOSH	D-NPN	$V_{CE0}=50B; I_C=150_{MA}; P_D=100_{mBT}; f_T>250_{MГц}; R1/R2=47/22_{кОм}$	B	E	C
YK	RN2110	TOSH	D-NPN	$V_{CE0}=50B; I_C=150_{MA}; P_D=100_{mBT}; f_T>250_{MГц}; R1=4.7_{кОм}$	B	E	C
YM	RN2121	TOSH	D-NPN	$V_{CE0}=50B; I_C=150_{MA}; P_D=100_{mBT}; f_T>250_{MГц}; R1=10_{кОм}$	B	E	C
YN	RN2112	TOSH	D-NPN	$V_{CE0}=50B; I_C=150_{MA}; P_D=100_{mBT}; f_T>250_{MГц}; R1=22_{кОм}$	B	E	C
YP	RN2113	TOSH	D-NPN	$V_{CE0}=50B; I_C=150_{MA}; P_D=100_{mBT}; f_T>250_{MГц}; R1=47_{кОм}$	B	E	C
YQ	RN2114	TOSH	D-NPN	$V_{CE0}=50B; I_C=150_{MA}; P_D=100_{mBT}; f_T>250_{MГц}; R1/R2=1/10_{кОм}$	B	E	C
YS	RN2115	TOSH	D-NPN	$V_{CE0}=50B; I_C=150_{MA}; P_D=100_{mBT}; f_T>250_{MГц}; R1/R2=2.2/10_{кОм}$	B	E	C
YT	RN2116	TOSH	D-NPN	$V_{CE0}=50B; I_C=150_{MA}; P_D=100_{mBT}; f_T>250_{MГц}; R1/R2=4.7/10_{кОм}$	B	E	C
YU	RN2117	TOSH	D-NPN	$V_{CE0}=50B; I_C=150_{MA}; P_D=100_{mBT}; f_T>250_{MГц}; R1/R2=10/4.7_{кОм}$	B	E	C
YW	RN2118	TOSH	D-NPN	$V_{CE0}=50B; I_C=150_{MA}; P_D=100_{mBT}; f_T>250_{MГц}; R1/R2=47/10_{кОм}$	B	E	C

SOT89

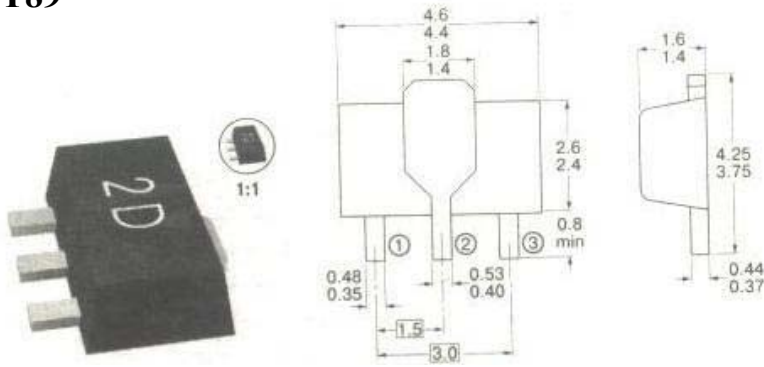

Код	Типономинал	Фирма	Функция	Особенности	Цоколевка		
					1	2	3
	BCX68	SIEM	NPN	$V_{CB0}=-20B$; $I_C=1A$; $P_D=1BT$; $h_{21}=85...375$; $f_T>100MГц$	B	E	C
	BCX69	SIEM	PNP	$V_{CB0}=-20B$; $I_C=-1A$; $P_D=1BT$; $h_{21}=85...375$; $f_T>100MГц$	B	E	C
1A	SXT3904	SIEM	NPN	$V_{CB0}=40B$; $I_C=200mA$; $P_D=1BT$; $h_{21}=100...300$; $f_T>300MГц$	B	E	C
1D	SXTA42	SIEM	NPN	$V_{CB0}=300B$; $I_C=500mA$; $P_D=1BT$; $h_{21}>40$; $f_T>50MГц$	B	E	C
1E	SXTA43	SIEM	NPN	$V_{CB0}=200B$; $I_C=500mA$; $P_D=1BT$; $h_{21}>40$; $f_T>50MГц$	B	E	C
10Y	BZV49-C10	PHIL	DZ	$V_Z(I_{ZT}=5.0mA)=9.4...10.6B$; $I_L(V_R=5.0B)<20 Ом$; $I_{ZM}=250mA$	A	K	A
11Y	BZV49-C11	PHIL	DZ	$V_Z(I_{ZT}=5.0mA)=10.4...11.6B$; $I_L(V_R=5.0B)<20 Ом$; $I_{ZM}=250mA$	A	K	A
12Y	BZV49-C12	PHIL	DZ	$V_Z(I_{ZT}=5.0mA)=11.4...12.7B$; $I_L(V_R=5.0B)<25 Ом$; $I_{ZM}=250mA$	A	K	A
13Y	BZV49-C13	PHIL	DZ	$V_Z(I_{ZT}=5.0mA)=12.4...14.1B$; $I_L(V_R=5.0B)<30 Ом$; $I_{ZM}=250mA$	A	K	A
15Y	BZV49-C15	PHIL	DZ	$V_Z(I_{ZT}=5.0mA)=13.8...15.6B$; $I_L(V_R=5.0B)<30 Ом$; $I_{ZM}=250mA$	A	K	A
16Y	BZV49-C16	PHIL	DZ	$V_Z(I_{ZT}=5.0mA)=15.3...17.1B$; $I_L(V_R=5.0B)<40 Ом$; $I_{ZM}=250mA$	A	K	A
18Y	BZV49-C18	PHIL	DZ	$V_Z(I_{ZT}=5.0mA)=16.8...19.1B$; $I_L(V_R=5.0B)<45 Ом$; $I_{ZM}=250mA$	A	K	A
20Y	BZV49-C20	PHIL	DZ	$V_Z(I_{ZT}=5.0mA)=18.8...21.2B$; $I_L(V_R=5.0B)<55 Ом$; $I_{ZM}=250mA$	A	K	A
22Y	BZV49-C22	PHIL	DZ	$V_Z(I_{ZT}=5.0mA)=20.8...23.3B$; $I_L(V_R=5.0B)<55 Ом$; $I_{ZM}=250mA$	A	K	A
24Y	BZV49-C24	PHIL	DZ	$V_Z(I_{ZT}=5.0mA)=22.8...25.6B$; $I_L(V_R=5.0B)<70 Ом$; $I_{ZM}=250mA$	A	K	A
27Y	BZV49-C27	PHIL	DZ	$V_Z(I_{ZT}=5.0mA)=25.1...28.9B$; $I_L(V_R=5.0B)<80 Ом$; $I_{ZM}=250mA$	A	K	A
2A	SXT3906	SIEM	PNP	$V_{CB0}=-40B$; $I_C=-200mA$; $P_D=1BT$; $h_{21}=100...300$; $f_T>250MГц$	B	E	C
2D	SXTA92	SIEM	PNP	$V_{CB0}=-300B$; $I_C=-500mA$; $P_D=1BT$; $h_{21}>25$; $f_T>50MГц$	B	E	C
2E	SXTA93	SIEM	PNP	$V_{CB0}=-200B$; $I_C=-500mA$; $P_D=1BT$; $h_{21}>25$; $f_T>50MГц$	B	E	C
2F	SXT2907A	SIEM	PNP	$V_{CB0}=-60B$; $I_C=-600mA$; $P_D=1BT$; $h_{21}=100...300$; $f_T>200MГц$	B	E	C
2P	SXT2222A	SIEM	NPN	$V_{CB0}=75B$; $I_C=600mA$; $P_D=1BT$; $h_{21}=100...300$; $f_T>300MГц$	B	E	C
2Y4	BZV49-C2V4	PHIL	DZ	$V_Z(I_{ZT}=5.0mA)=2.2...2.6B$; $I_L(V_R=5.0B)<100 Ом$; $I_{ZM}=250mA$	A	K	A
2Y7	BZV49-C2V7	PHIL	DZ	$V_Z(I_{ZT}=5.0mA)=2.5...2.9B$; $I_L(V_R=5.0B)<100 Ом$; $I_{ZM}=250mA$	A	K	A
30Y	BZV49-C30	PHIL	DZ	$V_Z(I_{ZT}=2.0mA)=28.0...32.0B$; $I_L(V_R=2.0B)<80 Ом$; $I_{ZM}=250mA$	A	K	A
33Y	BZV49-C33	PHIL	DZ	$V_Z(I_{ZT}=2.0mA)=31.0...35.0B$; $I_L(V_R=2.0B)<80 Ом$; $I_{ZM}=250mA$	A	K	A
36Y	BZV49-C36	PHIL	DZ	$V_Z(I_{ZT}=2.0mA)=34.0...38.0B$; $I_L(V_R=2.0B)<90 Ом$; $I_{ZM}=250mA$	A	K	A
39Y	BZV49-C39	PHIL	DZ	$V_Z(I_{ZT}=2.0mA)=37.0...41.0B$; $I_L(V_R=2.0B)<130 Ом$; $I_{ZM}=250mA$	A	K	A
3Y0	BZV49-C3V0	PHIL	DZ	$V_Z(I_{ZT}=5.0mA)=2.8...3.2B$; $I_L(V_R=5.0B)<95 Ом$; $I_{ZM}=250mA$	A	K	A
3Y3	BZV49-C3V3	PHIL	DZ	$V_Z(I_{ZT}=5.0mA)=3.1...3.5B$; $I_L(V_R=5.0B)<95 Ом$; $I_{ZM}=250mA$	A	K	A
3Y6	BZV49-C3V6	PHIL	DZ	$V_Z(I_{ZT}=5.0mA)=3.4...3.8B$; $I_L(V_R=5.0B)<90 Ом$; $I_{ZM}=250mA$	A	K	A

SOT89 (продолжение)

Код	Типономинал	Фирма	Функция	Особенности	Цоколевка		
					1	2	3
3Y9	BZV49-C3V9	PHIL	DZ	$V_Z(I_{ZT}=5.0\text{mA})=3.7\text{...}4.1\text{B}$; $I_L(V_R=5.0\text{B})<90\text{Om}$; $I_{ZM}=250\text{mA}$	A	K	A
43Y	BZV49-C43	PHIL	DZ	$V_Z(I_{ZT}=2.0\text{mA})=40.0\text{...}46.0\text{B}$; $I_L(V_R=2.0\text{B})<150\text{Om}$; $I_{ZM}=250\text{mA}$	A	K	A
47Y	BZV49-C47	PHIL	DZ	$V_Z(I_{ZT}=2.0\text{mA})=44.0\text{...}50.0\text{B}$; $I_L(V_R=2.0\text{B})<170\text{Om}$; $I_{ZM}=250\text{mA}$	A	K	A
4Y3	BZV49-C4V3	PHIL	DZ	$V_Z(I_{ZT}=5.0\text{mA})=4.0\text{...}4.6\text{B}$; $I_L(V_R=5.0\text{B})<90\text{Om}$; $I_{ZM}=250\text{mA}$	A	K	A
4Y7	BZV49-C4V7	PHIL	DZ	$V_Z(I_{ZT}=5.0\text{mA})=4.4\text{...}5.0\text{B}$; $I_L(V_R=5.0\text{B})<80\text{Om}$; $I_{ZM}=250\text{mA}$	A	K	A
51Y	BZV49-C51	PHIL	DZ	$V_Z(I_{ZT}=2.0\text{mA})=48.0\text{...}54.0\text{B}$; $I_L(V_R=2.0\text{B})<180\text{Om}$; $I_{ZM}=250\text{mA}$	A	K	A
56Y	BZV49-C56	PHIL	DZ	$V_Z(I_{ZT}=2.0\text{mA})=52.0\text{...}60.0\text{B}$; $I_L(V_R=2.0\text{B})<200\text{Om}$; $I_{ZM}=250\text{mA}$	A	K	A
5Y1	BZV49-C5V1	PHIL	DZ	$V_Z(I_{ZT}=5.0\text{mA})=4.8\text{...}5.4\text{B}$; $I_L(V_R=5.0\text{B})<60\text{Om}$; $I_{ZM}=250\text{mA}$	A	K	A
5Y6	BZV49-C5V6	PHIL	DZ	$V_Z(I_{ZT}=5.0\text{mA})=5.2\text{...}6.0\text{B}$; $I_L(V_R=5.0\text{B})<40\text{Om}$; $I_{ZM}=250\text{mA}$	A	K	A
62Y	BZV49-C62	PHIL	DZ	$V_Z(I_{ZT}=2.0\text{mA})=58.0\text{...}66.0\text{B}$; $I_L(V_R=2.0\text{B})<215\text{Om}$; $I_{ZM}=250\text{mA}$	A	K	A
68Y	BZV49-C68	PHIL	DZ	$V_Z(I_{ZT}=2.0\text{mA})=64.0\text{...}72.0\text{B}$; $I_L(V_R=2.0\text{B})<240\text{Om}$; $I_{ZM}=250\text{mA}$	A	K	A
6A	KIA7019AF	KEC	VD	$V_{RG}=1.9\text{B}$; $V_{CC}(\text{max})=15\text{B}$; $P_D=500\text{mBт}$	V_{CC}	GND	OUT
6B	KIA7021AF	KEC	VD	$V_{RG}=2.1\text{B}$; $V_{CC}(\text{max})=15\text{B}$; $P_D=500\text{mBт}$	V_{CC}	GND	OUT
6C	KIA7023AF	KEC	VD	$V_{RG}=2.3\text{B}$; $V_{CC}(\text{max})=15\text{B}$; $P_D=500\text{mBт}$	V_{CC}	GND	OUT
6D	KIA7025AF	KEC	VD	$V_{RG}=2.5\text{B}$; $V_{CC}(\text{max})=15\text{B}$; $P_D=500\text{mBт}$	V_{CC}	GND	OUT
6E	KIA7027AF	KEC	VD	$V_{RG}=2.7\text{B}$; $V_{CC}(\text{max})=15\text{B}$; $P_D=500\text{mBт}$	V_{CC}	GND	OUT
6F	KIA7029AF	KEC	VD	$V_{RG}=2.9\text{B}$; $V_{CC}(\text{max})=15\text{B}$; $P_D=500\text{mBт}$	V_{CC}	GND	OUT
6G	KIA7031AF	KEC	VD	$V_{RG}=3.1\text{B}$; $V_{CC}(\text{max})=15\text{B}$; $P_D=500\text{mBт}$	V_{CC}	GND	OUT
6H	KIA7032AF	KEC	VD	$V_{RG}=3.2\text{B}$; $V_{CC}(\text{max})=15\text{B}$; $P_D=500\text{mBт}$	V_{CC}	GND	OUT
6J	KIA7033AF	KEC	VD	$V_{RG}=3.3\text{B}$; $V_{CC}(\text{max})=15\text{B}$; $P_D=500\text{mBт}$	V_{CC}	GND	OUT
6K	KIA7034AF	KEC	VD	$V_{RG}=3.4\text{B}$; $V_{CC}(\text{max})=15\text{B}$; $P_D=500\text{mBт}$	V_{CC}	GND	OUT
6L	KIA7035AF	KEC	VD	$V_{RG}=3.5\text{B}$; $V_{CC}(\text{max})=15\text{B}$; $P_D=500\text{mBт}$	V_{CC}	GND	OUT
6M	KIA7036AF	KEC	VD	$V_{RG}=3.6\text{B}$; $V_{CC}(\text{max})=15\text{B}$; $P_D=500\text{mBт}$	V_{CC}	GND	OUT
6N	KIA7039AF	KEC	VD	$V_{RG}=3.9\text{B}$; $V_{CC}(\text{max})=15\text{B}$; $P_D=500\text{mBт}$	V_{CC}	GND	OUT
6P	KIA7042AF	KEC	VD	$V_{RG}=4.2\text{B}$; $V_{CC}(\text{max})=15\text{B}$; $P_D=500\text{mBт}$	V_{CC}	GND	OUT
6R	KIA7045AF	KEC	VD	$V_{RG}=4.5\text{B}$; $V_{CC}(\text{max})=15\text{B}$; $P_D=500\text{mBт}$	V_{CC}	GND	OUT
6Y2	BZV49-C6V2	PHIL	DZ	$V_Z(I_{ZT}=5.0\text{mA})=5.8\text{...}6.6\text{B}$; $I_L(V_R=5.0\text{B})<10\text{Om}$; $I_{ZM}=250\text{mA}$	A	K	A
6Y8	BZV49-C6V8	PHIL	DZ	$V_Z(I_{ZT}=5.0\text{mA})=6.4\text{...}7.2\text{B}$; $I_L(V_R=5.0\text{B})<15\text{Om}$; $I_{ZM}=250\text{mA}$	A	K	A
75Y	BZV49-C75	PHIL	DZ	$V_Z(I_{ZT}=2.0\text{mA})=70.0\text{...}79.0\text{B}$; $I_L(V_R=2.0\text{B})<255\text{Om}$; $I_{ZM}=250\text{mA}$	A	K	A
7Y5	BZV49-C7V5	PHIL	DZ	$V_Z(I_{ZT}=5.0\text{mA})=7.0\text{...}7.92\text{B}$; $I_L(V_R=5.0\text{B})<15\text{Om}$; $I_{ZM}=250\text{mA}$	A	K	A
8Y2	BZV49-C8V2	PHIL	DZ	$V_Z(I_{ZT}=5.0\text{mA})=7.7\text{...}8.7\text{B}$; $I_L(V_R=5.0\text{B})<15\text{Om}$; $I_{ZM}=250\text{mA}$	A	K	A
9Y1	BZV49-C9V1	PHIL	DZ	$V_Z(I_{ZT}=5.0\text{mA})=8.5\text{...}9.6\text{B}$; $I_L(V_R=5.0\text{B})<15\text{Om}$; $I_{ZM}=250\text{mA}$	A	K	A
A27	PXTA27	PHIL	NPN	$V_{CB0}=60\text{B}$; $I_C=500\text{mA}$; $P_D=1\text{Bт}$; $h_{21}>100$; $f_T>125\text{MГц}$	B	E	C
AA	BCX51	PHIL	PNP	$V_{CB0}=-45\text{B}$; $I_C=-1\text{A}$; $P_D=1\text{Bт}$; $h_{21}=40\text{...}250$; $f_T=50\text{MГц}$	B	E	C
AA	BCX51	SIEM	PNP	$V_{CB0}=-45\text{B}$; $I_C=-1\text{A}$; $P_D=1\text{Bт}$; $h_{21}=40\text{...}250$; $f_T=125\text{MГц}$	B	E	C
AB	BCX51-6	PHIL	PNP	$V_{CB0}=-45\text{B}$; $I_C=-1\text{A}$; $P_D=1\text{Bт}$; $h_{21}=40\text{...}100$; $f_T=125\text{MГц}$	B	E	C
AC	BCX51-10	PHIL	PNP	$V_{CB0}=-45\text{B}$; $I_C=-1\text{A}$; $P_D=1\text{Bт}$; $h_{21}=63\text{...}160$; $f_T=50\text{MГц}$	B	E	C
AC	BCX51-10	SIEM	PNP	$V_{CB0}=-45\text{B}$; $I_C=-1\text{A}$; $P_D=1\text{Bт}$; $h_{21}=63\text{...}160$; $f_T=125\text{MГц}$	B	E	C
AC	2SA1690	ROHM	PNP	$V_{CB0}=-400\text{B}$; $I_C=-100\text{mA}$; $P_D=2\text{Bт}$; $h_{21}=56\text{...}270$	B	E	C
AD	BCX51-16	PHIL	PNP	$V_{CB0}=-45\text{B}$; $I_C=-1\text{A}$; $P_D=1\text{Bт}$; $h_{21}=100\text{...}250$; $f_T=50\text{MГц}$	B	E	C
AD	BCX51-16	SIEM	PNP	$V_{CB0}=-45\text{B}$; $I_C=-1\text{A}$; $P_D=1\text{Bт}$; $h_{21}=100\text{...}250$; $f_T=125\text{MГц}$	B	E	C
AE	BCX52	PHIL	PNP	$V_{CB0}=-60\text{B}$; $I_C=-1\text{A}$; $P_D=1\text{Bт}$; $h_{21}=40\text{...}250$; $f_T=50\text{MГц}$	B	E	C
AE	BCX52	SIEM	PNP	$V_{CB0}=-60\text{B}$; $I_C=-1\text{A}$; $P_D=1\text{Bт}$; $h_{21}=40\text{...}250$; $f_T=125\text{MГц}$	B	E	C
AEP	2SB1424	ROHM	PNP	$V_{CB0}=-20\text{B}$; $I_C=-3\text{A}$; $P_D=500\text{mBт}$; $h_{21}=82\text{...}180$; $f_T>240\text{MГц}$	B	E	C
AEQ	2SB1424	ROHM	PNP	$V_{CB0}=-20\text{B}$; $I_C=-3\text{A}$; $P_D=500\text{mBт}$; $h_{21}=120\text{...}270$; $f_T>240\text{MГц}$	B	E	C
AER	2SB1424	ROHM	PNP	$V_{CB0}=-20\text{B}$; $I_C=-3\text{A}$; $P_D=500\text{mBт}$; $h_{21}=180\text{...}390$; $f_T>240\text{MГц}$	B	E	C
AF	BCX52-06	PHIL	PNP	$V_{CB0}=-60\text{B}$; $I_C=-1\text{A}$; $h_{21}=40\text{...}100$; $f_T=125\text{MГц}$	B	E	C
AF	BCX52-6	SIEM	PNP	$V_{CB0}=-60\text{B}$; $I_C=-1\text{A}$; $P_D=1\text{Bт}$; $h_{21}=40\text{...}100$; $f_T=125\text{MГц}$	B	E	C
AG	BCX52-10	PHIL	PNP	$V_{CB0}=-60\text{B}$; $I_C=-1\text{A}$; $P_D=1\text{Bт}$; $h_{21}=63\text{...}160$; $f_T=50\text{MГц}$	B	E	C

SOT89 (продолжение)

Код	Типономинал	Фирма	Функция	Особенности	Цоколевка		
					1	2	3
AG	BCX52-10	SIEM	PNP	$V_{CB0}=-60B; I_C=-1A; P_D=1BТ; h_{21}=63...160; f_T=125MГц$	B	E	C
AGP	2SA1797	ROHM	PNP	$V_{CB0}=-50B; I_C=-2A; P_D=500MВТ; h_{21}=82...180; f_T>200MГц$	B	E	C
AGQ	2SA1797	ROHM	PNP	$V_{CB0}=-50B; I_C=-2A; P_D=500MВТ; h_{21}=120...270; f_T>200MГц$	B	E	C
AH	BCX53	PHIL	PNP	$V_{CB0}=-100B; I_C=-1A; P_D=1BТ; h_{21}=40...250; f_T=50MГц$	B	E	C
AH	BCX53	SIEM	PNP	$V_{CB0}=-80B; I_C=-1A; P_D=1BТ; h_{21}=40...250; f_T=125MГц$	B	E	C
AHN	2SA1759	ROHM	PNP	$V_{CB0}=-400B; I_C=-100MA; P_D=500MВТ; h_{21}=56...120; f_T>12MГц$	B	E	C
AHP	2SA1759	ROHM	PNP	$V_{CB0}=-400B; I_C=-100MA; P_D=500MВТ; h_{21}=82...180; f_T>12MГц$	B	E	C
AHQ	2SA1759	ROHM	PNP	$V_{CB0}=-400B; I_C=-100MA; P_D=500MВТ; h_{21}=120...270; f_T>12MГц$	B	E	C
AHQ	2SD2098	ROHM	NPN	$V_{CB0}=50B; I_C=5A; P_D=500MВТ; h_{21}=120...270; f_T>150MГц$	B	E	C
AHR	2SD2098	ROHM	NPN	$V_{CB0}=50B; I_C=5A; P_D=500MВТ; h_{21}=180...390; f_T>150MГц$	B	E	C
AHS	2SD2098	ROHM	NPN	$V_{CB0}=50B; I_C=5A; P_D=500MВТ; h_{21}=270...560; f_T>150MГц$	B	E	C
AJ	BCX53-6	PHIL	PNP	$V_{CB0}=-100B; I_C=-1A; h_{21}=40...100; f_T=50MГц$	B	E	C
AJ	BCX53-6	SIEM	PNP	$V_{CB0}=-80B; I_C=-1A; P_D=1BТ; h_{21}=40...100; f_T=125MГц$	B	E	C
AJN	2SA1812	ROHM	PNP	$V_{CB0}=-400B; I_C=-500MA; P_D=500MВТ; h_{21}=56...120; f_T>12MГц$	B	E	C
AJP	2SA1812	ROHM	PNP	$V_{CB0}=-400B; I_C=-100MA; P_D=500MВТ; h_{21}=82...180; f_T>12MГц$	B	E	C
AJQ	2SA1812	ROHM	PNP	$V_{CB0}=-400B; I_C=-100MA; P_D=500MВТ; h_{21}=120...270; f_T>12MГц$	B	E	C
AK	BCX53-10	PHIL	PNP	$V_{CB0}=-100B; I_C=-1A; P_D=1BТ; h_{21}=63...160; f_T=50MГц$	B	E	C
AK	BCX53-10	SIEM	PNP	$V_{CB0}=-80B; I_C=-1A; P_D=1BТ; h_{21}=63...160; f_T=125MГц$	B	E	C
AL	BCX53-16	PHIL	PNP	$V_{CB0}=-100B; I_C=-1A; P_D=1BТ; h_{21}=100...250; f_T=50MГц$	B	E	C
AL	BCX53-16	SIEM	PNP	$V_{CB0}=-80B; I_C=-1A; P_D=1BТ; h_{21}=100...250; f_T=125MГц$	B	E	C
ALP	2SA1900	ROHM	PNP	$V_{CB0}=-60B; I_C=-1A; P_D=500MВТ; h_{21}=82...180; f_T>150MГц$	B	E	C
ALQ	2SA1900	ROHM	PNP	$V_{CB0}=-60B; I_C=-1A; P_D=500MВТ; h_{21}=120...270; f_T>150MГц$	B	E	C
ALR	2SA1900	ROHM	PNP	$V_{CB0}=-60B; I_C=-1A; P_D=500MВТ; h_{21}=180...390; f_T>150MГц$	B	E	C
AM	BCX52-16	PHIL	PNP	$V_{CB0}=-60B; I_C=-1A; P_D=1BТ; h_{21}=100...250; f_T=50MГц$	B	E	C
AM	BCX52-16	SIEM	PNP	$V_{CB0}=-60B; I_C=-1A; P_D=1BТ; h_{21}=100...250; f_T=125MГц$	B	E	C
AR	2SC3338	HIT	NPN	$V_{CB0}=20B; I_C=50MA; P_D=400MВТ; P_G=8,3dB; f_T>3.5ГГц$	B	E	C
AR1	BSR40	PHIL	NPN	$V_{CB0}=70B; I_C=1A; P_D=1BТ; h_{21}=40...120; f_T>100MГц$	B	E	C
AR2	BSR41	PHIL	NPN	$V_{CB0}=70B; I_C=1A; P_D=1BТ; h_{21}=100...300; f_T>100$	B	E	C
AR3	BSR42	PHIL	NPN	$V_{CB0}=90B; I_C=1A; P_D=1BТ; h_{21}=40...120; f_T>100MГц$	B	E	C
AR4	BSR43	PHIL	NPN	$V_{CB0}=90B; I_C=1A; P_D=1BТ; h_{21}=100...300; f_T>100MГц$	B	E	C
AS1	BST50	PHIL	NPN	$V_{CB0}=60B; I_C=500MA; P_D=1BТ; h_{21}>2000$	B	E	C
AS2	BST51	PHIL	NPN	$V_{CB0}=80B; I_C=500MA; P_D=1BТ; h_{21}>2000$	B	E	C
AS3	BST52	PHIL	NPN	$V_{CB0}=90B; I_C=500MA; P_D=1BТ; h_{21}>2000$	B	E	C
AT1	BST39	PHIL	NPN	$V_{CB0}=400B; I_C=1A; P_D=1BТ; h_{21}>40; f_T>70MГц$	B	E	C
AT2	BST40	PHIL	NPN	$V_{CB0}=300B; I_C=1A; P_D=1BТ; h_{21}>40; f_T>70MГц$	B	E	C
ATN	2SA1812	ROHM	PNP	$V_{CB0}=-400B; I_C=-500MA; P_D=500MВТ; h_{21}=56...120; f_T>12MГц$	B	E	C
ATP	2SA1812	ROHM	PNP	$V_{CB0}=-400B; I_C=-500MA; P_D=500MВТ; h_{21}=82...180; f_T>12MГц$	B	E	C
ATQ	2SA1812	ROHM	PNP	$V_{CB0}=-400B; I_C=-500MA; P_D=500MВТ; h_{21}=120...270; f_T>12MГц$	B	E	C
BA	BCX54	PHIL	NPN	$V_{CB0}=45B; I_C=1A; P_D=1BТ; h_{21}=40...250; f_T=130MГц$	B	E	C
BA	BCX54	SIEM	NPN	$V_{CB0}=45B; I_C=1A; P_D=1BТ; h_{21}=40...250; f_T=100MГц$	B	E	C
BAP	2SB1132	ROHM	PNP	$V_{CB0}=-40B; I_C=-1A; P_D=500MВТ; h_{21}=82...180; f_T>150MГц$	B	E	C
BAQ	2SB1132	ROHM	PNP	$V_{CB0}=-40B; I_C=-1A; P_D=500MВТ; h_{21}=120...270; f_T>150MГц$	B	E	C
BAR	2SB1132	ROHM	PNP	$V_{CB0}=-40B; I_C=-1A; P_D=500MВТ; h_{21}=180...390; f_T>150MГц$	B	E	C
BB	BCX54-6	PHIL	NPN	$V_{CB0}=45B; I_C=1A; P_D=1BТ; h_{21}=40...100; f_T=100MГц$	B	E	C
BB	BCX54-6	SIEM	NPN	$V_{CB0}=45B; I_C=1A; P_D=1BТ; h_{21}=40...100; f_T=100MГц$	B	E	C
BC	BCX54-10	PHIL	NPN	$V_{CB0}=45B; I_C=1A; P_D=1BТ; h_{21}=63...160; f_T=130MГц$	B	E	C
BC	BCX54-10	SIEM	NPN	$V_{CB0}=45B; I_C=1A; P_D=1BТ; h_{21}=63...160; f_T=100MГц$	B	E	C
BSP	2SB1188	ROHM	PNP	$V_{CB0}=-40B; I_C=-2A; P_D=500MВТ; h_{21}=82...180; f_T>100MГц$	B	E	C

SOT89 (продолжение)

Код	Типономинал	Фирма	Функция	Особенности	Цоколевка		
					1	2	3
BCQ	2SB1188	ROHM	PNP	$V_{CB0}=-40B; I_C=-2A; P_D=500MВт; h_{21}=120...270; f_T>100MГц$	B	E	C
BCR	2SB1188	ROHM	PNP	$V_{CB0}=-40B; I_C=-2A; P_D=500MВт; h_{21}=180...390; f_T>100MГц$	B	E	C
BD	BCX54-16	PHIL	NPN	$V_{CB0}=45B; I_C=1A; P_D=1Вт; h_{21}=100...250; f_T=130MГц$	B	E	C
BD	BCX54-16	SIEM	NPN	$V_{CB0}=45B; I_C=1A; P_D=1Вт; h_{21}=100...250; f_T=100MГц$	B	E	C
BDP	2SB1189	ROHM	PNP	$V_{CB0}=-80B; I_C=-700MA; P_D=500MВт; h_{21}=82...180; f_T>100MГц$	B	E	C
BDQ	2SB1189	ROHM	PNP	$V_{CB0}=-80B; I_C=-700MA; P_D=500MВт; h_{21}=120...270; f_T>100MГц$	B	E	C
BDR	2SB1189	ROHM	PNP	$V_{CB0}=-80B; I_C=-700MA; P_D=500MВт; h_{21}=180...390; f_T>100MГц$	B	E	C
BE	BCX55	PHIL	NPN	$V_{CB0}=60B; I_C=1A; P_D=1Вт; h_{21}=40...250; f_T=130MГц$	B	E	C
BE	BCX55	SIEM	NPN	$V_{CB0}=60B; I_C=1A; P_D=1Вт; h_{21}=40...250; f_T=100MГц$	B	E	C
BE	2SB1260	ROHM	PNP	$V_{CB0}=-80B; I_C=-1A; P_D=2Вт; h_{21}=82...390; f_T>100MГц$	B	E	C
BF	BCX55-06	SIEM	NPN	$V_{CB0}=60B; I_C=1A; P_D=1Вт; h_{21}=40...100; f_T=100MГц$	B	E	C
BF	BCX55-6	PHIL	NPN	$V_{CB0}=60B; I_C=1A; P_D=1Вт; h_{21}=40...100; f_T=100MГц$	B	E	C
BFP	2SB1308	ROHM	PNP	$V_{CB0}=-30B; I_C=-3A; P_D=500MВт; h_{21}=82...180; f_T>120MГц$	B	E	C
BFQ	2SB1308	ROHM	PNP	$V_{CB0}=-30B; I_C=-3A; P_D=500MВт; h_{21}=120...270; f_T>120MГц$	B	E	C
BFR	2SB1308	ROHM	PNP	$V_{CB0}=-30B; I_C=-3A; P_D=500MВт; h_{21}=180...390; f_T>120MГц$	B	E	C
BG	BCX55-10	PHIL	NPN	$V_{CB0}=60B; I_C=1A; P_D=1Вт; h_{21}=63...160; f_T=130MГц$	B	E	C
BG	BCX55-10	SIEM	NPN	$V_{CB0}=60B; I_C=1A; P_D=1Вт; h_{21}=63...160; f_T=100MГц$	B	E	C
BH	BCX56	PHIL	NPN	$V_{CB0}=100B; I_C=1A; P_D=1Вт; h_{21}=40...250; f_T=130MГц$	B	E	C
BH	BCX56	SIEM	NPN	$V_{CB0}=80B; I_C=1A; P_D=1Вт; h_{21}=40...250; f_T=100MГц$	B	E	C
BHP	2SB1386	ROHM	PNP	$V_{CB0}=-30B; I_C=-5A; P_D=500MВт; h_{21}=82...180; f_T>120MГц$	B	E	C
BHQ	2SB1386	ROHM	PNP	$V_{CB0}=-30B; I_C=-5A; P_D=500MВт; h_{21}=120...270; f_T>120MГц$	B	E	C
BHR	2SB1386	ROHM	PNP	$V_{CB0}=-30B; I_C=-5A; P_D=500MВт; h_{21}=180...390; f_T>120MГц$	B	E	C
BJ	BCX56-06	SIEM	NPN	$V_{CB0}=80B; I_C=1A; P_D=1Вт; h_{21}=40...100; f_T=100MГц$	B	E	C
BJ	BCX56-6	PHIL	NPN	$V_{CB0}=80B; I_C=1A; P_D=1Вт; h_{21}=40...100; f_T=50MГц$	B	E	C
BJE	2SB1427	ROHM	PNP	$V_{CB0}=-20B; I_C=-2A; P_D=500MВт; h_{21}=390...820; f_T>90MГц$	B	E	C
BJS	2SB1427	ROHM	PNP	$V_{CB0}=-20B; I_C=-2A; P_D=500MВт; h_{21}=270...560; f_T>90MГц$	B	E	C
BJU	2SB1427	ROHM	PNP	$V_{CB0}=-20B; I_C=-2A; P_D=500MВт; h_{21}=560...1200; f_T>90MГц$	B	E	C
BK	BCX56-10	PHIL	NPN	$V_{CB0}=100B; I_C=1A; P_D=1Вт; h_{21}=63...160; f_T=130MГц$	B	E	C
BK	BCX56-10	SIEM	NPN	$V_{CB0}=80B; I_C=1A; P_D=1Вт; h_{21}=63...160; f_T=100MГц$	B	E	C
BL	BCX56-16	PHIL	NPN	$V_{CB0}=100B; I_C=1A; P_D=1Вт; h_{21}=100...250; f_T=130MГц$	B	E	C
BL	BCX56-16	SIEM	NPN	$V_{CB0}=80B; I_C=1A; P_D=1Вт; h_{21}=100...250; f_T=100MГц$	B	E	C
BLP	2SB1561	ROHM	PNP	$V_{CB0}=-60B; I_C=-2A; P_D=500MВт; h_{21}=82...180; f_T>200MГц$	B	E	C
BLQ	2SB1561	ROHM	PNP	$V_{CB0}=-60B; I_C=-2A; P_D=500MВт; h_{21}=120...270; f_T>200MГц$	B	E	C
BM	BCX55-16	PHIL	NPN	$V_{CB0}=60B; I_C=1A; P_D=1Вт; h_{21}=100...250; f_T=130MГц$	B	E	C
BM	BCX55-16	SIEM	NPN	$V_{CB0}=60B; I_C=1A; P_D=1Вт; h_{21}=100...250; f_T=100MГц$	B	E	C
BO	2SA1200	TOSH	PNP	$V_{CE0}=-150B; I_C=-50MA; P_D=500MВт; h_{21}>70...140; f_T>120MГц$	B	E	C
BO	KTA1660	KEC	PNP	$V_{CB0}=-150B; I_C=-50MA; P_D=500MВт; h_{21}=70...140; f_T>120MГц$	B	E	C
BR1	BSR30	PHIL	PNP	$V_{CB0}=-70B; I_C=-1A; P_D=1Вт; h_{21}=40...120; f_T>100MГц$	B	E	C
BR2	BSR31	PHIL	PNP	$V_{CB0}=-70B; I_C=-1A; P_D=1Вт; h_{21}=100...300; f_T>100MГц$	B	E	C
BR3	BSR32	PHIL	PNP	$V_{CB0}=-90B; I_C=-1A; P_D=1Вт; h_{21}=40...120; f_T>100MГц$	B	E	C
BR4	BSR33	PHIL	PNP	$V_{CB0}=-90B; I_C=-1A; P_D=1Вт; h_{21}=100...300; f_T>100MГц$	B	E	C
BS1	BST60	PHIL	PNP	$V_{CE0}=-60B; I_C=-500MA; P_D=1Вт; h_{21}>2000$	B	E	C
BS2	BST61	PHIL	PNP	$V_{CE0}=-80B; I_C=-500MA; P_D=1Вт; h_{21}>2000$	B	E	C
BS3	BST62	PHIL	PNP	$V_{CE0}=-90B; I_C=-500MA; P_D=1Вт; h_{21}>2000$	B	E	C
BT1	BST15	PHIL	PNP	$V_{CB0}=-200B; I_C=-1A; P_D=1Вт; h_{21}=30...150; f_T>15MГц$	B	E	C
BT2	BST16	PHIL	PNP	$V_{CB0}=-350B; I_C=-1A; P_D=1Вт; h_{21}=30...120; f_T>15MГц$	B	E	C
BY	2SA1200	TOSH	PNP	$V_{CE0}=-150B; I_C=-50MA; P_D=500MВт; h_{21}>120...240; f_T>120MГц$	B	E	C
BY	KTA1660	KEC	PNP	$V_{CB0}=-150B; I_C=-50MA; P_D=500MВт; h_{21}=120...240; f_T>120MГц$	B	E	C
CAC	BC868	PHIL	NPN	$V_{CB0}=25B; I_C=1A; P_D=1Вт; h_{21}=85...375; f_T>40MГц$	B	E	C

SOT89 (продолжение)

Код	Типономинал	Фирма	Функция	Особенности	Цоколевка		
					1	2	3
CB	BCX68-10	SIEM	NPN	$V_{CB0}=20B; I_C=1A; P_D=1BT; h_{21}=85...160; f_T=100MГц$	B	E	C
CBC	BC868-10	PHIL	NPN	$V_{CB0}=25B; I_C=1A; P_D=1BT; h_{21}=160...500; f_T>40MГц$	B	E	C
CBN	2SC4132	ROHM	NPN	$V_{CB0}=120B; I_C=2A; P_D=500mBT; h_{21}=56...120; f_T>80MГц$	B	E	C
CBP	2SC4132	ROHM	NPN	$V_{CB0}=120B; I_C=2A; P_D=500mBT; h_{21}=82...180; f_T>80MГц$	B	E	C
CBQ	2SC4132	ROHM	NPN	$V_{CB0}=120B; I_C=2A; P_D=500mBT; h_{21}=120...270; f_T>80MГц$	B	E	C
CBR	2SC4132	ROHM	NPN	$V_{CB0}=120B; I_C=2A; P_D=500mBT; h_{21}=180...390; f_T>80MГц$	B	E	C
CC	BCX68-16	SIEM	NPN	$V_{CB0}=20B; I_C=1A; P_D=1BT; h_{21}=100...250; f_T=100MГц$	B	E	C
CCC	BC868-16	PHIL	NPN	$V_{CB0}=25B; I_C=1A; P_D=1BT; h_{21}=100...250; f_T>40MГц$	B	E	C
CD	BCX68-25	SIEM	NPN	$V_{CB0}=20B; I_C=1A; P_D=1BT; h_{21}=160...375; f_T=100MГц$	B	E	C
CDC	BC68-25	PHIL	NPN	$V_{CB0}=25B; I_C=1A; P_D=1BT; h_{21}>160; f_T>40MГц$	B	E	C
CEC	BC869	PHIL	PNP	$V_{CB0}=-25B; I_C=-1A; P_D=1BT; h_{21}=85...375; f_T>40MГц$	B	E	C
CEN	2SC4504	ROHM	NPN	$V_{CB0}=400B; I_C=100mA; P_D=500mBT; h_{21}=56...120; f_T>20MГц$	B	E	C
CEP	2SC4504	ROHM	NPN	$V_{CB0}=400B; I_C=100mA; P_D=500mBT; h_{21}=82...180; f_T>20MГц$	B	E	C
CEQ	2SC4504	ROHM	NPN	$V_{CB0}=400B; I_C=100mA; P_D=500mBT; h_{21}=120...270; f_T>20MГц$	B	E	C
CF	BCX69-10	SIEM	PNP	$V_{CB0}=-20B; I_C=-1A; P_D=1BT; h_{21}=85...160; f_T=100MГц$	B	E	C
CFC	BC869-10	PHIL	PNP	$V_{CB0}=-25B; I_C=-1A; P_D=1BT; h_{21}>160; f_T>40MГц$	B	E	C
CFQ	2SD2150	ROHM	NPN	$V_{CB0}=40B; I_C=3A; P_D=500mBT; h_{21}=120...270; f_T>290MГц$	B	E	C
CFR	2SD2150	ROHM	NPN	$V_{CB0}=40B; I_C=3A; P_D=500mBT; h_{21}=180...390; f_T>290MГц$	B	E	C
CFS	2SD2150	ROHM	NPN	$V_{CB0}=40B; I_C=3A; P_D=500mBT; h_{21}=270...560; f_T>290MГц$	B	E	C
CG	BCX69-16	SIEM	PNP	$V_{CB0}=-20B; I_C=-1A; P_D=1BT; h_{21}=100...250; f_T=100MГц$	B	E	C
CGC	BC869-16	PHIL	PNP	$V_{CB0}=-25B; I_C=-1A; P_D=1BT; h_{21}=100...250; f_T>40MГц$	B	E	C
CGP	2S5053	ROHM	NPN	$V_{CB0}=60B; I_C=1A; P_D=500mBT; h_{21}=82...180; f_T>150MГц$	B	E	C
CGQ	2S5053	ROHM	NPN	$V_{CB0}=60B; I_C=1A; P_D=500mBT; h_{21}=120...270; f_T>150MГц$	B	E	C
CGR	2S5053	ROHM	NPN	$V_{CB0}=60B; I_C=1A; P_D=500mBT; h_{21}=180...390; f_T>150MГц$	B	E	C
CH	BCX69-25	SIEM	PNP	$V_{CB0}=-20B; I_C=-1A; P_D=1BT; h_{21}=160...375; f_T=100MГц$	B	E	C
CHC	BC869-25	PHIL	PNP	$V_{CB0}=-25B; I_C=-1A; P_D=1BT; h_{21}=160; f_T>40MГц$	B	E	C
CR	2SC4422	HIT	NPN	$V_{CB0}=15B; I_C=50mA; P_D=400mBT; h_{21}=50-250; f_T>4.5ГГц$	B	E	C
DA	BF622	PHIL	NPN	$V_{CB0}=250B; I_C=50mA; P_D=1BT; h_{21}>50; f_T>60MГц$	B	E	C
DA	BF622	SIEM	NPN	$V_{CB0}=250B; I_C=50mA; P_D=1BT; h_{21}>50; f_T=100MГц$	B	E	C
DAP	2SD1664	ROHM	NPN	$V_{CB0}=40B; I_C=1A; P_D=500mBT; h_{21}=82...180; f_T>150MГц$	B	E	C
DAQ	2SD1664	ROHM	NPN	$V_{CB0}=40B; I_C=1A; P_D=500mBT; h_{21}=120...270; f_T>150MГц$	B	E	C
DAR	2SD1664	ROHM	NPN	$V_{CB0}=40B; I_C=1A; P_D=500mBT; h_{21}=180...390; f_T>150MГц$	B	E	C
DB	BF623	PHIL	PNP	$V_{CB0}=-250B; I_C=-50mA; P_D=1BT; h_{21}>50; f_T>60MГц$	B	E	C
DB	BF623	SIEM	PNP	$V_{CB0}=-250B; I_C=-50mA; P_D=1BT; h_{21}>50; f_T=100MГц$	B	E	C
DBP	2SD1766	ROHM	NPN	$V_{CB0}=40B; I_C=2A; P_D=500mBT; h_{21}=82...180; f_T>100MГц$	B	E	C
DBQ	2SD1766	ROHM	NPN	$V_{CB0}=40B; I_C=2A; P_D=500mBT; h_{21}=120...270; f_T>100MГц$	B	E	C
DBR	2SD1766	ROHM	NPN	$V_{CB0}=40B; I_C=2A; P_D=500mBT; h_{21}=180...390; f_T>100MГц$	B	E	C
DC	BF620	PHIL	NPN	$V_{CB0}=300B; I_C=50mA; P_D=1BT; h_{21}>50; f_T>60MГц$	B	E	C
DC	BFN23	SIEM	NPN	$V_{CB0}=300B; I_C=50mA; P_D=1BT; h_{21}>40; f_T=100MГц$	B	E	C
DCP	2SD1767	ROHM	NPN	$V_{CB0}=80B; I_C=700mA; P_D=500mBT; h_{21}=82...180; f_T>120MГц$	B	E	C
DCQ	2SD1767	ROHM	NPN	$V_{CB0}=80B; I_C=700mA; P_D=500mBT; h_{21}=120...270; f_T>120MГц$	B	E	C
DCR	2SD1767	ROHM	NPN	$V_{CB0}=80B; I_C=700mA; P_D=500mBT; h_{21}=180...390; f_T>120MГц$	B	E	C
DD	BFN23	SIEM	NPN	$V_{CB0}=250B; I_C=200mA; P_D=1BT; h_{21}>40; f_T>70MГц$	B	E	C
DDP	2SD1766	ROHM	NPN	$V_{CB0}=40B; I_C=2A; P_D=500mBT; h_{21}=82...180; f_T>100MГц$	B	E	C
DDQ	2SD1766	ROHM	NPN	$V_{CB0}=40B; I_C=2A; P_D=500mBT; h_{21}=120...270; f_T>100MГц$	B	E	C
DDR	2SD1766	ROHM	NPN	$V_{CB0}=40B; I_C=2A; P_D=500mBT; h_{21}=180...390; f_T>100MГц$	B	E	C

SOT89 (продолжение)

Код	Типономинал	Фирма	Функция	Особенности	Цоколевка		
					1	2	3
DE	2SD1834	ROHM	NPN	$V_{CB0}=60B; I_C=1A; P_D=500mBт; h_{21}>2000$	B	E	C
DE	BFN18	SIEM	NPN	$V_{CB0}=300B; I_C=200mA; P_D=1Bт; h_{21}>30; f_T>70MГц$	B	E	C
DF	BF621	PHIL	PNP	$V_{CB0}=-300B; I_C=-50mA; P_D=1Bт; h_{21}>50; f_T>60MГц$	B	E	C
DF	BFN21	SIEM	PNP	$V_{CB0}=-300B; I_C=-50mA; P_D=1Bт; h_{21}>40; f_T=100MГц$	B	E	C
DF	2SD1898	ROHM	NPN	$V_{CB0}=80B; I_C=1A; P_D=2Bт; h_{21}=82...390; f_T>100MГц$	B	E	C
DG	BFN17	SIEM	PNP	$V_{CB0}=-250B; I_C=-200mA; P_D=1Bт; h_{21}>40; f_T=100MГц$	B	E	C
DGQ	2SD1963	ROHM	NPN	$V_{CB0}=50B; I_C=3A; P_D=500mBт; h_{21}=120...270; f_T>150MГц$	B	E	C
DGR	2SD1963	ROHM	NPN	$V_{CB0}=50B; I_C=3A; P_D=500mBт; h_{21}=180...390; f_T>150MГц$	B	E	C
DGS	2SD1963	ROHM	NPN	$V_{CB0}=50B; I_C=3A; P_D=500mBт; h_{21}=270...560; f_T>150MГц$	B	E	C
DH	BFN19	SIEM	PNP	$V_{CB0}=-300B; I_C=-200mA; P_D=1Bт; h_{21}>30; f_T=100MГц$	B	E	C
DJQ	2SD2098	ROHM	NPN	$V_{CB0}=50B; I_C=5A; P_D=500mBт; h_{21}=120...270; f_T>150MГц$	B	E	C
DJR	2SD2098	ROHM	NPN	$V_{CB0}=50B; I_C=5A; P_D=500mBт; h_{21}=180...390; f_T>150MГц$	B	E	C
DJS	2SD2098	ROHM	NPN	$V_{CB0}=50B; I_C=5A; P_D=500mBт; h_{21}=270...560; f_T>150MГц$	B	E	C
DKP	2SC4672	ROHM	NPN	$V_{CB0}=60B; I_C=2A; P_D=500mBт; h_{21}=82...180; f_T>210MГц$	B	E	C
DKQ	2SC4672	ROHM	NPN	$V_{CB0}=60B; I_C=2A; P_D=500mBт; h_{21}=120...270; f_T>210MГц$	B	E	C
DLN	2SD2167	ROHM	NPN	$V_{CB0}=31B; I_C=2A; P_D=500mBт; h_{21}=56...120; f_T>100MГц$	B	E	C
DLQ	2SD2167	ROHM	NPN	$V_{CB0}=31B; I_C=2A; P_D=500mBт; h_{21}=120...270; f_T>100MГц$	B	E	C
DLP	2SD2167	ROHM	NPN	$V_{CB0}=31B; I_C=2A; P_D=500mBт; h_{21}=82...180; f_T>100MГц$	B	E	C
DM	2SD2170	ROHM	NPN	$V_{CB0}=90B; I_C=2A; P_D=500mBт; h_{21}=1000...10000; f_T>80MГц$	B	E	C
DO	2SA1201	TOSH	PNP	$V_{CE0}=-120B; I_C=-800mA; P_D=500mBт; h_{21}>70...140; f_T=120MГц$	B	E	C
DP	2SD2195	ROHM	NPN	$V_{CB0}=100B; I_C=2A; P_D=500mBт; h_{21}=1000...10000; f_T>80MГц$	B	E	C
DQN	2SD2211	ROHM	NPN	$V_{CB0}=160B; I_C=1500mA; P_D=500mBт; h_{21}=56...120; f_T>80MГц$	B	E	C
DQP	2SD2211	ROHM	NPN	$V_{CB0}=160B; I_C=1500mA; P_D=500mBт; h_{21}=82...180; f_T>80MГц$	B	E	C
DQQ	2SD2211	ROHM	NPN	$V_{CB0}=160B; I_C=1500mA; P_D=500mBт; h_{21}=120...270; f_T>80MГц$	B	E	C
DR	2SC4643	HIT	NPN	$V_{CB0}=15B; I_C=50mA; P_D=400mBт; h_{21}=40-250; f_T>5.5TГц$	B	E	C
DR	2SD2212	ROHM	NPN	$V_{CB0}=60B; I_C=2A; P_D=500mBт; h_{21}=1000...10000; f_T>80MГц$	B	E	C
DTP	2SD2391	ROHM	NPN	$V_{CB0}=60B; I_C=2A; P_D=500mBт; h_{21}=82...180; f_T>210MГц$	B	E	C
DTQ	2SD2391	ROHM	NPN	$V_{CB0}=60B; I_C=2A; P_D=500mBт; h_{21}=120...270; f_T>210MГц$	B	E	C
DY	2SA1201	TOSH	PNP	$V_{CE0}=-120B; I_C=-800mA; P_D=500mBт; h_{21}>120...240; f_T=120MГц$	B	E	C
E01	DTDG14GP	ROHM	D-NPN	$V_{CB0}=60B; I_C=1A; P_D=500mBт; h_{21}>300; f_T>80MГц; R_2=10kOm$	B	E	C
ED	BCV28	SIEM	PNP	$V_{CB0}=-40B; I_C=-500mA; P_D=1Bт; h_{21}>100; f_T=200MГц$	B	E	C
EE	BCV48	SIEM	PNP	$V_{CB0}=-80B; I_C=-500mA; P_D=1Bт; h_{21}>400; f_T=200MГц$	B	E	C
EF	BCV29	SIEM	NPN	$V_{CB0}=40B; I_C=500mA; P_D=1Bт; h_{21}>100; f_T=150MГц$	B	E	C
EG	BCV49	SIEM	NPN	$V_{CB0}=80B; I_C=500mA; P_D=1Bт; h_{21}>400; f_T=150MГц$	B	E	C
FGs	BFQ19S	SIEM	NPN	$V_{CB0}=20B; I_C=75mA; P_D=1Bт; h_{21}=40...220; f_T=5500MГц$	B	E	C
FO	2SA1202	TOSH	PNP	$V_{CE0}=-80B; I_C=-400mA; P_D=500mBт; h_{21}>70...140; f_T=120MГц$	B	E	C
FY	2SA1202	TOSH	PNP	$V_{CE0}=-80B; I_C=-400mA; P_D=500mBт; h_{21}>120...240; f_T=120MГц$	B	E	C
GA	BAW78A	SIEM	DI	$V_R<50B; I_F<1A; V_F(I_F=1A)<1.6B; I_R<1.0mA; C_D<10пФ; t_{RR}<1000нс$	A	K	nc
GB	BAW78B	SIEM	DI	$V_R<100B; I_F<1A; V_F(I_F=1A)<1.6B; I_R<1.0mA; C_D<10пФ; t_{RR}<1000нс$	A	K	nc
GC	BAW78C	SIEM	DI	$V_R<200B; I_F<1A; V_F(I_F=1A)<1.6B; I_R<1.0mA; C_D<10пФ; t_{RR}<1000нс$	A	K	nc
GD	BAW78D	SIEM	DI	$V_R<400B; I_F<1A; V_F(I_F=1A)<1.6B; I_R<1.0mA; C_D<10пФ; t_{RR}<1000нс$	A	K	nc
GE	BAW79A	SIEM	2xDI	$V_R<50B; I_F<1A; V_F(I_F=1A)<1.6B; I_R<1.0mA; C_D<10пФ; t_{RR}<1000нс$	A1	K1 K2	A2
GF	BAW79B	SIEM	2xDI	$V_R<100B; I_F<1A; V_F(I_F=1A)<1.6B; I_R<1.0mA; C_D<10пФ; t_{RR}<1000нс$	A1	K1 K2	A2
GG	BAW79C	SIEM	2xDI	$V_R<200B; I_F<1A; V_F(I_F=1A)<1.6B; I_R<1.0mA; C_D<10пФ; t_{RR}<1000нс$	A1	K1 K2	A2
GH	BAW79D	SIEM	2xDI	$V_R<400B; I_F<1A; V_F(I_F=1A)<1.6B; I_R<1.0mA; C_D<10пФ; t_{RR}<1000нс$	A1	K1 K2	A2
GO	KTC4375	KEC	NPN	$V_{CB0}=30B; I_C=1.5A; P_D=500mBт; h_{21}=100...200; f_T>120MГц$	B	E	C
GY	KTC4375	KEC	NPN	$V_{CB0}=30B; I_C=1.5A; P_D=500mBт; h_{21}=160...320; f_T>120MГц$	B	E	C
HO	2SA1203	TOSH	PNP	$V_{CB0}=-30B; I_C=-1.5A; P_D=500mBт; h_{21}=100...200; f_T=200MГц$	B	E	C
HO	KTA1663	KEC	PNP	$V_{CB0}=-30B; I_C=-1.5A; P_D=500mBт; h_{21}=100...200; f_T>120MГц$	B	E	C
HY	2SA1203	TOSH	PNP	$V_{CE0}=-30B; I_C=-1.5A; P_D=500mBт; h_{21}>160...320; f_T=120MГц$	B	E	C
HY	KTA1663	KEC	PNP	$V_{CB0}=-30B; I_C=-1.5A; P_D=500mBт; h_{21}=160...320; f_T>120MГц$	B	E	C
JO	2SA1384	TOSH	NPN	$V_{CE0}=-30B; I_C=-100mA; P_D=500mBт; h_{21}>50...150; f_T>50MГц$	B	E	C
JR	2SA1384	TOSH	NPN	$V_{CE0}=-30B; I_C=-100mA; P_D=500mBт; h_{21}>30...90; f_T>50MГц$	B	E	C
KA	2SC4409	TOSH	NPN	$V_{CE0}=80B; I_C=2A; P_D=500mBт; h_{21}>120...240; f_T=100MГц$	B	E	C
KA	BSS87	SIEM	nMOS	$V_{DS}=240B; I_D=290mA; P_D=1Bт; g_F=50mC; R_{DS}=10Om$	G	D	S
KB	2SC4539	TOSH	NPN	$V_{CE0}=30B; I_C=1.2A; P_D=500mBт; h_{21}>120...400; f_T=100MГц$	B	E	C

SOT89 (продолжение)

Код	Типономинал	Фирма	Функция	Особенности	Цоколевка		
					1	2	3
KB	BSS192	SIEM	pMOS	$V_{DS}=-240B; I_D=-150mA; P_D=1Bт; g_F=120MCM; R_{DS}=3.5OM$	G	D	S
KC	2SC4540	TOSH	NPN	$V_{CE0}=50B; I_C=1A; P_D=500MBт; h_{21}>120...400; f_T=100MГц$	B	E	C
KD	2SC4541	TOSH	NPN	$V_{CE0}=50B; I_C=3A; P_D=1500MBт; h_{21}>120...400; f_T=100MГц$	B	E	C
LA	2SC1681	TOSH	PNP	$V_{CE0}=-60B; I_C=-2A; P_D=500MBт; h_{21}>120...400; f_T=100MГц$	B	E	C
LA	KTD1003	KEC	NPN	$V_{CB0}=60B; I_C=1.0A; P_D=500MBт; h_{21}=800...1600; f_T>250MГц$	B	E	C
LB	2SC1734	TOSH	PNP	$V_{CE0}=-40B; I_C=-1.2A; P_D=500MBт; h_{21}>120...400; f_T=100MГц$	B	E	C
LB	KTD1003	KEC	NPN	$V_{CB0}=60B; I_C=1.0A; P_D=500MBт; h_{21}=1200...2400; f_T>250MГц$	B	E	C
LC	2SC1735	TOSH	PNP	$V_{CE0}=-60B; I_C=-1A; P_D=500MBт; h_{21}=120...400; f_T=100MГц$	B	E	C
LC	KTD1003	KEC	NPN	$V_{CB0}=60B; I_C=1.0A; P_D=500MBт; h_{21}=2000...3200; f_T>250MГц$	B	E	C
LD	2SC1736	TOSH	PNP	$V_{CE0}=-60B; I_C=-3A; P_D=500MBт; h_{21}=120...400; f_T=100MГц$	B	E	C
N01	DTDM12ZP	ROHM	D-NPN	$V_{CB0}=30B; I_C=3A; P_D=500MBт; h_{21}>68; f_T>80MГц$	B	E	C
p1A	PXT3904	PHIL	NPN	$V_{CB0}=60B; I_C=200MA; P_D=1Bт; h_{21}=100...300; f_T>300MГц$	B	E	C
p1B	PXT2222	PHIL	NPN	$V_{CB0}=60B; I_C=600MA; P_D=1Bт; h_{21}=100...300; f_T>250MГц$	B	E	C
p1D	PXTA42	PHIL	NPN	$V_{CB0}=300B; I_C=500MA; P_D=1Bт; h_{21}>40; f_T>50MГц$	B	E	C
p1E	PXTA43	PHIL	NPN	$V_{CB0}=200B; I_C=500MA; P_D=1Bт; h_{21}>40; f_T>50MГц$	B	E	C
p1N	PXTA14	PHIL	NPN	$V_{CB0}=30B; I_C=300MA; P_D=1Bт; h_{21}>20000; f_T>125MГц$	B	E	C
p1P	PXT2222A	PHIL	NPN	$V_{CB0}=75B; I_C=600MA; P_D=1Bт; h_{21}=100...300; f_T>300MГц$	B	E	C
p2A	PXT3906	PHIL	PNP	$V_{CB0}=-40B; I_C=-200MA; P_D=1Bт; h_{21}=100...300; f_T>250MГц$	B	E	C
p2B	PXT2907	PHIL	PNP	$V_{CB0}=-60B; I_C=-600MA; P_D=1Bт; h_{21}=100...300; f_T>200MГц$	B	E	C
p2D	PXTA92	PHIL	PNP	$V_{CB0}=-300B; I_C=-500MA; P_D=1Bт; h_{21}>40; f_T>50MГц$	B	E	C
p2E	PXTA93	PHIL	PNP	$V_{CB0}=-200B; I_C=-500MA; P_D=1Bт; h_{21}>40; f_T>50MГц$	B	E	C
p2F	PXT2907A	PHIL	PNP	$V_{CB0}=-60B; I_C=-600MA; P_D=1Bт; h_{21}=100...300; f_T>200MГц$	B	E	C
p2F	PXT2907A	PHIL	PNP	$V_{CB0}=-60B; I_C=-600MA; P_D=1Bт; h_{21}=100...300; f_T>200MГц$	B	E	C
p2T	PXT4403	PHIL	PNP	$V_{CB0}=-40B; I_C=-600MA; P_D=1Bт; h_{21}=100...300; f_T>200MГц$	B	E	C
p2V	PXTA64	PHIL	PNP	$V_{CB0}=-30B; I_C=-300MA; P_D=1Bт; h_{21}>10000; f_T>125MГц$	B	E	C
p2X	PXT4401	PHIL	NPN	$V_{CB0}=40B; I_C=600MA; P_D=1Bт; h_{21}=100...300; f_T>250MГц$	B	E	C
PO	KTC4376	KEC	NPN	$V_{CB0}=35B; I_C=0.8A; P_D=500MBт; h_{21}=100...200; f_T>120MГц$	B	E	C
PY	KTC4376	KEC	NPN	$V_{CB0}=35B; I_C=0.8A; P_D=500MBт; h_{21}=160...320; f_T>120MГц$	B	E	C
RCs	BFQ193	SIEM	NPN	$V_{CB0}=20B; I_C=80MA; P_D=600MBт; h_{21}=50...200; f_T=7500MГц$	B	E	C
RO	2SA1204	TOSH	PNP	$V_{CE0}=-35B; I_C=-800MA; P_D=500MBт; h_{21}>100...200; f_T=120MГц$	B	E	C
RO	KTA1664	KEC	PNP	$V_{CB0}=-35B; I_C=-0.8A; P_D=500MBт; h_{21}=100...200; f_T>120MГц$	B	E	C
RY	2SA1204	TOSH	PNP	$V_{CE0}=-35B; I_C=-800MA; P_D=500MBт; h_{21}>160...320; f_T=120MГц$	B	E	C
RY	KTA1664	KEC	PNP	$V_{CB0}=-35B; I_C=-0.8A; P_D=500MBт; h_{21}=160...320; f_T>120MГц$	B	E	C
SA	2SC2982	TOSH	NPN	$V_{CE0}=30B; I_C=2A; P_D=500MBт; h_{21}>140...240; f_T=140MГц$	B	E	C
SB	2SC2982	TOSH	NPN	$V_{CE0}=30B; I_C=2A; P_D=500MBт; h_{21}>200...330; f_T=140MГц$	B	E	C
SC	2SC2982	TOSH	NPN	$V_{CE0}=30B; I_C=2A; P_D=500MBт; h_{21}>300...450; f_T=140MГц$	B	E	C
SCO	KSC2881	SAMS	NPN	$V_{CE0}=30B; I_C=2A; P_D=500MBт; h_{21}>300...450; f_T=140MГц$	B	E	C
SCY	KSC2881	SAMS	NPN	$V_{CB0}=120B; I_C=800MA; P_D=500MBт; h_{21}=120...240; f_T>120MГц$	B	E	C
SD	2SC2982	TOSH	NPN	$V_{CE0}=30B; I_C=2A; P_D=500MBт; h_{21}>420...600; f_T=140MГц$	B	E	C
SDO	KSA1201	SAMS	PNP	$V_{CB0}=-120B; I_C=-800MA; P_D=500MBт; h_{21}=80...160; f_T>120MГц$	B	E	C
SDO	KSA1203	SAMS	PNP	$V_{CB0}=-30B; I_C=-1.5A; P_D=500MBт; h_{21}=100...200; f_T>120MГц$	B	E	C
SDY	KSA1201	SAMS	PNP	$V_{CB0}=-120B; I_C=-800MA; P_D=500MBт; h_{21}=120...240; f_T>120MГц$	B	E	C
SDY	KSA1203	SAMS	PNP	$V_{CB0}=-30B; I_C=-1.5A; P_D=500MBт; h_{21}=160...320; f_T>120MГц$	B	E	C
SHO	KSC2883	SAMS	NPN	$V_{CB0}=30B; I_C=1500MA; P_D=500MBт; h_{21}=100...200; f_T>120MГц$	B	E	C
SHY	KSC2883	SAMS	NPN	$V_{CB0}=30B; I_C=1500MA; P_D=500MBт; h_{21}=160...320; f_T>120MГц$	B	E	C
SLG	KSB798	SAMS	PNP	$V_{CB0}=-30B; I_C=-1A; P_D=2Bт; h_{21}=200...400; f_T>110MГц$	B	E	C
SLO	KSB798	SAMS	PNP	$V_{CB0}=-30B; I_C=-1A; P_D=2Bт; h_{21}=90...180; f_T>110MГц$	B	E	C
SLY	KSB798	SAMS	PNP	$V_{CB0}=-30B; I_C=-1A; P_D=2Bт; h_{21}=135...270; f_T>110MГц$	B	E	C
SSA	KSC2982	SAMS	NPN	$V_{CB0}=30B; I_C=2A; P_D=500MBт; h_{21}=140...240; f_T>150MГц$	B	E	C
SSB	KSC2982	SAMS	NPN	$V_{CB0}=30B; I_C=2A; P_D=500MBт; h_{21}=200...330; f_T>150MГц$	B	E	C
SSC	KSC2982	SAMS	NPN	$V_{CB0}=30B; I_C=2A; P_D=500MBт; h_{21}=300...450; f_T>150MГц$	B	E	C
SSD	KSC2982	SAMS	NPN	$V_{CB0}=30B; I_C=2A; P_D=500MBт; h_{21}=420...600; f_T>150MГц$	B	E	C
SYR	KSD1621	SAMS	NPN	$V_{CB0}=30B; I_C=2A; P_D=500MBт; h_{21}=100...200; f_T>150MГц$	B	E	C
SYS	KSD1621	SAMS	NPN	$V_{CB0}=30B; I_C=2A; P_D=500MBт; h_{21}=140...280; f_T>150MГц$	B	E	C
SYT	KSD1621	SAMS	NPN	$V_{CB0}=30B; I_C=2A; P_D=500MBт; h_{21}=200...400; f_T>150MГц$	B	E	C
SYU	KSD1621	SAMS	NPN	$V_{CB0}=30B; I_C=2A; P_D=500MBт; h_{21}=280...560; f_T>150MГц$	B	E	C
SZR	KSB1121	SAMS	PNP	$V_{CB0}=-30B; I_C=-2A; P_D=500MBт; h_{21}=100...200; f_T>150MГц$	B	E	C
SZS	KSB1121	SAMS	PNP	$V_{CB0}=-30B; I_C=-2A; P_D=500MBт; h_{21}=140...280; f_T>150MГц$	B	E	C
SZT	KSB1121	SAMS	PNP	$V_{CB0}=-30B; I_C=-2A; P_D=500MBт; h_{21}=200...400; f_T>150MГц$	B	E	C
SZU	KSB1121	SAMS	PNP	$V_{CB0}=-30B; I_C=-2A; P_D=500MBт; h_{21}=280...560; f_T>150MГц$	B	E	C
TA	2SA1314	TOSH	PNP	$V_{CE0}=-20B; I_C=-2A; P_D=500MBт; h_{21}>140...280; f_T=140MГц$	B	E	C

SOT89 (продолжение)

Код	Типономинал	Фирма	Функция	Особенности	Цоколевка		
					1	2	3
TB	2SA1314	TOSH	PNP	$V_{CE0}=-20B; I_C=-2A; P_D=500мВт; h_{21}>200...400; f_T=140МГц$	B	E	C
TC	2SA1314	TOSH	PNP	$V_{CE0}=-20B; I_C=-2A; P_D=500мВт; h_{21}>300...600; f_T=140МГц$	B	E	C
VO	2SC3803	TOSH	NPN	$V_{CE0}=45; I_C=200мА; P_D=1Вт; h_{21}>70...140; f_T>100МГц$	B	E	C
VR	2SC3803R	TOSH	NPN	$V_{CE0}=45; I_C=200мА; P_D=1Вт; h_{21}>40...80; f_T>100МГц$	B	E	C
VY	2SC3803Y	TOSH	NPN	$V_{CE0}=45; I_C=200мА; P_D=1Вт; h_{21}>140...280; f_T>100МГц$	B	E	C
VY	2SC3803Y	TOSH	NPN	$V_{CE0}=45; I_C=200мА; P_D=1Вт; h_{21}>140...280; f_T>200МГц$	B	E	C

Список сокращений и аббревиатур названий
зарубежных фирм – производителей.

Сокр-ние	Полное название фирмы
8X8	8x8, Inc.
ACAP	Acapella, Ltd.
ACC	ACC Miroelectronics Corp.
ACCUL	Acculin, Inc.
ACTEL	Actel Corporation
AD	Analog Devices
ADAP	Adaptec
AEROF	Aeroflex Corcuit Technology
AHA	Advanced Hardware Architectures, Inc.
AIT	AITech International
AKM	AKM Semiconductor, Inc.
ALD	Advanced Linear Devices
ALLEG	Allegro Micro Systems, Inc.
ALLIA	Alliance Semiconductor
ALPHA	Alpha Semiconductor
ALT	AverLogic Tehnologies, Inc.
ALTER	Altera Corporation
AMC	Accutek Microcircuit Corporation
AMCC	AMCC (Applied Micro Circuits Corp)
AMD	Advanced Micro Devices, Inc.
AMI	American Microsystems, Inc.
AMS	Applied Microsystems Corporation
AMSI	Austria Micro Systeme International, Inc.
ANAD	Anadigics, Inc.
ANALO	Analogic Corporation
APEX	Apex Microtechnology Corporation
APTEX	Aptek Williams, Inc.
APTOS	Aptos Semiconductor Corporation
ARRAY	Array Microsystems
AS	Analog Systems
ASHL	Ashling Microsystems Ltd.
ASPEC	Aspec Technology, Inc.
ASTEC	Astec Semiconductor
ATMEL	Atmel Corporation
AUST	Austin Semiconductor Inc.
AVG	AVG Semiconductors
AVX	AVX kyocera
B-B	Burr-Brown Corporation
BEL	Bel Fuse Incorporated
BENCH	Benchmark Microelectronics
BOUR	BOURNS
BROOK	Brooktree Corporation
BUTT	Butterfly DSP, Inc.
C&T	Chips and Technologies, Incorporated
CALOG	Calogic Corporation
CATAL	Catalyst Semiconductors
CCD	Cologne Chip Designs
CDIL	CDIL
CEC	Chip Express Corporation

Сокр-ние	Полное название фирмы
CENTO	Centon Electronics, Inc.
CENTS	Central Semiconductor, Inc.
CENTU	Century Microelectronics, Inc.
CERM	Cermetec Microelectronics, Inc.
CHERR	Cherry Semiconductor Corporation
CHRON	Chrontel
CL	Cirrus Logic, Inc.
CMDC	California Micro Devices Corporation
CML	Consumer Microcircuits Limited
COLOR	Colorado Microcircuits
COMC	Comcore Semiconductor
COML	Comlinear Corporation
CONV	Conversion Devices, Inc.
CPC	CP Clare Corporation
CPS	Crosspoint Solutions, Inc.
CROSS	Crossline Semiconductor, Inc.
CRYST	Crystal
CTC	CTC
CYBER	Cybernetic Micro Systems
CYPR	Cyress Semiconductor Corp.
CYRIX	Cyrix Corporation
DALL	Dallas Semiconductor
DALSA	Dalsa Incorporated
DATEL	Datel, Inc.
DDD	Data Delay Devices, Inc.
DENSE	Dense-Pac Microsystems, Inc.
DIGIT	Digital Semiconductor
DION	Dionics Inc.
DSPG	DSP Group, Inc.
EDGE	Edge Technology, Inc.
EDI	Electronic Designs Inc.
EG&GI	EG&GI IC Sensors
EG&GR	EG&GR Reticon Corporation
ELANT	Elantec, Inc.
ELET	Eletech Electronics
ELMOS	Elmos Electronik in MOS-Technologie GmbH
ELNA	ELNA
EMBED	Embedded Support Tools Corp.
EMM	EM Microelectronics
EMS	Enhanced Memory Systems
EMUL	Emulation Tehnology, Inc.
ENABL	Enable Semiconductor, Inc.
EPSON	Epson America Inc.
ERIC	Ericsson Components
ESC	ESC Electronics Corporation
ESS	ESS Tehnology, Inc.
ETC	Electronic Tehnology Corporation
EUROM	Eurom Ltd.
EXAR	Exar Corporation

Список сокращений и аббревиатур названий
зарубежных фирм – производителей (продолжение)

Сокр-ние	Полное название фирмы
EXEL	EXEL Microelectronics, Inc.
EXPO	Exponential Tehnology, Inc.
FAIR	Fairchild Semiconductor
FUJIT	Fujitsu Microelectronics, Inc.
GALIL	Galileo Tehnology
GENES	Genesis Microchip Inc.
GENN	Gennum Corporation
GETE	GETb Engineering Corp.
G-LINK	G-Link Tehnology Corporation
GOAL	Goal Electronics Inc.
GREEN	Greenwich Instruments USA
GS	General Semiconductors
GSI	GSI Tehnology
HARR	Harris Corporation
HIFN	Hifn
HIT	Hitachi Semiconductor (America), Inc.
HOLT	Holt Integrated Circuits, Inc.
HOLTE	Holtek Microelectronics Inc.
HONEY	Honeywell Solid State Electronics Ctr.
HP	Hewlett-Packard-Logic Systems Division
HUAL	Hualon Microelectronics Corp.
HUGH	Hughes Aircraft Co.
HUNT	Hantsville Microsystems, Inc.
HYU	Hyundai Electronics America
IBM	IBM Corporation
IC-H	IC Haus
ICS	Integrated Circuit Systems, Inc.
ICT	ICT Inc.
IC-W	IC Works, Inc.
IDEAL	Ideal Semiconductor
IDT	Integrated Device Tehnology, Inc.
ILC	ILC Data Device Corp.
ILS	Integrated Logic Systems Inc.
IMI	International Microcircuits, Inc.
IMP	IMP, Inc.
IMPAL	Impala Linear Corporation
INTEL	Intel Corporation
INTRO	Intronics, Inc.
IO	Iotech, Inc.
IPC	Interpoint Corporation
IR	International Rectifier Corp.
ISD	Informatio Storage Devices, Inc
ISOC	Isocom Incorporated
ISS	Integrated Silicon Solution Inc.
IST	International Semiconductor Tehnologies
ITI	Interface Tehnology, Inc.
ITT	ITT Semiconductor
ITTI	Integrated Telecom Tehnology, Inc.
IXYS	IXYS Corporation

Сокр-ние	Полное название фирмы
KAWAS	Kawasaki LSI, USA
KEC	Korean Electr. Corp.
KEMET	KEMET
KRUE	Krueger Company
LAMBD	Lambda Advanced Analog
LANSD	Lansdate Semiconductor, Inc.
LATT	Lattice Semiconductor Corp.
LD	Logic Devices Inc.
LECRO	LeCroy Corporation
LEVEL	Level One
LG	LG Semicon Company, Ltd.
LINF	Linfinity Microelectronics
LINT	Lintel security S. A
LIS	Linear Integrated Systems
LM	Lockheed martin
LSI-C	LSI Computer Systems, inc.
LSI-L	LSI logic Corporation
LT	Linear Tehnology Corporation
LUC	Lucent Tehnologies Inc.
M/A	M/A-COM, Inc.
MALL	Mallory
MARV	Marvell Semiconductor, Inc.
MATRA	Matra MHS, Inc.
MATS	Matsuo
MAXIM	Maxim Integrated Products
M-C	Mini-Circuits
M-CHIP	Microchip Tehnology, Inc.
MICR	Micrel
MICRO	Microtek International, Inc.
MII	Micropac industries, Inc.
MISI	Micronix Integrated Systems, Inc.
MITEL	Mitel Semiconductor
MITS	Mitsubishi Electronics America, Inc.
ML	Micro Linear
MLINK	MetaLink Corporation
MNC	Micro Networks Company
MOSAI	Mosaic Semiconductor, Inc.
MOSEL	Mosel-Vitelic
MOSYS	MOSYS
MOT	Motorola Semiconductor Products
MPSC	MagePOWER Semiconductor Corporation
M-R	Micro-Rel
MSIC	Mixed Signal Integration Corporation
MSIS	MSIS Semiconductor, Incorporated
MTI	Micron Tehnology, Inc.
MUR	Murata
MUSIC	Music Semiconductors, Inc.
MX-C	MX-COM, Inc.
NACC	NACC
NANO	Nanoteq (Pty) Ltd

Список сокращений и аббревиатур названий
зарубежных фирм – производителей (продолжение)

Сокр-ние	Полное название фирмы
NCM	NCM Corporation
NEC	NEC Electronics Inc.
NEWP	Newport Components Limited
NEXC	Nexcom Technology, Inc.
NI	National Instruments
NJR	NJR Corporation
NOHAU	Nohau Corporation
NOVER	Nover
NPC	Nippon Precision Circuits Ltd.
NPNX	NPNX Corporation
NS	National Semiconductor Corporation
NTE	NTE Electronics, Inc.
OAK	Oak Technology, Inc.
OEI	Optical Electronics Inc.
OKI	OKI Semiconductor, Inc.
ONCH	OnChip System, Inc.
OPTEK	Optek Technology, Inc.
OPTI	OPTi Inc.
OPTO	Optotec Limited
ORBIT	Orbit Semiconductor Inc.
ORION	Orion Instruments, Inc.
OXFOR	Oxford Micro Device, Inc.
PANAS	Panasonic Industrial Company Electronic Comp.
PARAD	Paradigm Technology, Inc.
PCA	PCA Electronics Inc.
PCC	Power Convertibles Corporation
P-EGG	Philips ECG
PEPS	Performance Electronic Packaging Services
PERIC	Pericom Semiconductor Corporation
PHIL	Philips Semiconductors
PHYLO	Phylon Inc.
PI	Power Integration, Inc.
PLESS	GEC Plessey Semiconductors
PLX	PLX Technology, Inc.
PMC-S	PMC-Sierra
PMD	Performance Motion Devices, Inc.
PSC	Performance Semiconductor Corp.
PT	Power Trends
QLC	QuickLogic Corp.
QLOG	Qlogic Corporation
QS	Quality Semiconductor
QUALC	Qualcomm Incorporated
R&E	R&E International, Inc.
RAMTR	Ramtron Corporation
RAYTH	Raytheon Company
REALT	Realtek Semiconductor Corporation
RF-M	RF Micro Devices
RICOH	Ricoh Corporation
RMV	RMV Electronics

Сокр-ние	Полное название фирмы
ROCH	Rochester Electronics Incorporated
ROCK	Rockwell Semiconductor Systems
ROHM	ROHM Corporation
S+M	Siemens Matsushita Components.
SAMS	Samsung Semiconductor, Inc.
SANYO	Sanyo Semiconductor Corporation
SCI	Silicon Composers, Inc.
SEEQ	SEEQ Technology, Incorporated
SEI	Space Electronics Incorporated
SEIKO	Seiko Instruments USA, Inc.
SEMT	Semtech Corporation
SENS	Sensory, Inc.
SEPON	Seponix Corporation
SHARP	Sharp Electronics Corporation
SIEM	Siemens Microelectronics Inc.
SIGN	Signum Systems
SIL	Siliconix Inc.
SILIC	Silicom Inc.
SIMT	Simtek Corporation
SINC	Sincera
SIPEX	Sipex Corporation
SIS	SIS Microelectronics, Inc.
SMC	Standard Microsystems Corporation
S-MOS	S-MOS System, Inc.
SMS	Samsung Microwave Semiconductor, Inc.
SOFT	Soft Device
SOLIT	Solitron Device, Inc.
SONY	Sony Semiconductor Company of America
SOUTH	South African Micro-Electronic Systems (Pry) Ltd.
SPACE	Space Research Tehnology, Inc.
SPT	Signal Processing Tehnologies
SS	Silicon Systems Inc.
SST	Silicon Storage Tehnology, Inc.
ST	SGS-THOMSON Microelectronics, Inc.
STANF	Stanford Telecommunications Inc.
SUMIT	Sumitomo Metal Industries, Ltd.
SUN	Sun Microsystems, Inc.
SUPER	Supertex, Inc.
SYFER	Syfer
SYMB	Symbios Logic
SYNER	Synergy Semiconductor Corporation
SYNT	Syntax Yehnology Inc.
SYSTR	Systronix. Inc.
TDK	TDK Semiconductor Corp.
TECH	Technitrol Pulse Components Div.
TELC	TelCom Semiconductor
TELEF	Telefunken Semiconductors
TELT	Teltone Corporation
TEMIC	Temic Semiconductors

**Список сокращений и аббревиатур названий
зарубежных фирм – производителей (продолжение)**

Сокр-ние	Полное название фирмы
THAL	Thaler Corp
THAT	THAT Corporation
THES	Thesys Gesellschaft fur Mikroelektronik mbH
THIRD	Third Domain, Inc.
THOMS	Thomson Components and Corporation
TI	Texas Instruments, Inc.
TLSI	TLSI Incorporated
TOKO	Toko America Incorporated
TOSH	Toshiba America Electronic Components, Inc.
TRANS	TranSwich Corporation
TRID	Trident Microsystems Incorporated
TRIQ	TriQuint Semiconductor
TRITE	TriTech Microelectronics
TSENG	Tseng Labs, Inc.
TSQW	Tsquare, Inc.
TUNDR	Tundra Semiconductor Corporation
TURBO	Turbo IC, Inc.
UMC	United Microelectronics Corporation
UNITR	Unitrode Integrated Circuits Corp.
UNIV	Universal Semiconductor Inc.
USM	US MikroChips, Inc.
USAR	USAR Systems, Inc.
UTM	United Technologies Microelectronics Center
V3	V3 Semiconductor

Сокр-ние	Полное название фирмы
VADEM	Vadem
VANT	Vantis Corporation
VETRA	Vetra Systems Corporation
VIA	VIA Technologies, Inc.
VISH	Vishay Lite On
VITES	Vitesse Semiconductor Corp.
VITR	Vitramon
VLSI	VLSI Technology Inc.
VORT	Vortex Incorporated
VTC	VTC Inc.
WAFER	Waferscale Integration Inc. Western Digital Corporation
WD	Western Digital Corporation
WDC	The Western Design Center, Inc.
WELTR	Weltrend
WHITE	White Microelectronics
WINB	Winbond Electronics Corp.
WOLF	Wolfson Microelectronics
XECOM	Xecom, Inc.
XICOR	Xicor, Inc.
XILIN	Xilinx Corp.
YAGEO	Yageo
YAMA	Yamaha Corp of America
ZAXT	Zaxtek, Inc.
ZETEX	Zetex

**Список
общих сокращений и аббревиатур**

Сокр-ние	Полное название фирмы
EIA	Electronic Industries Association
EIAJ	Electronic Industries Association of Japan
IEC	International Electrotechnical Commission
JEDEC	Joint Electronic Device Engineering Council
SIA	Semiconductor Industry Association
ISO	International Organization for Standardization

Полное название фирмы
Ассоциация электронной промышленности (США)
Ассоциация электронной промышленности (Япония)
Международная Электротехническая Комиссия
Объединенный технический совет по электронным приборам
Ассоциация полупроводниковой промышленности (США)
Международная организация по стандартизации

**Список
сокращений и аббревиатур в графе «Цоколевка»**

A	Anode
B	Base
C	Collector
D	Drain
E	emitter

Анод
База
Коллектор
Сток
Эмиттер

G	Gate
K	Kathode (Cathode)
S	Source
nc	Not connect
x	

Затвор
Катод
Исток
не подсоединен
безразличное состояние

Список
сокращений и аббревиатур в графе «Функция»

Сокр-ние	Полное название фирмы
BD	варикал
BTD	динистор
BYD	Быстрый выпрямительный диод с «мягким» восстановлением
BYG	Выпрямительный диод общего применения
BYH	Быстрый высоковольтный выпрямительный диод с «мягким» восстановлением
BYV	Высоковольтный выпрямительный диод
CPIN	Переключательный р-і-п диод
D	Диод общего применения
DI	Импульсный диод
DIH	Импульсный диод с большим рабочим током
DL	Диод общего применения с малым током утечки
DL	Лавинный диод
dNPN	п-р-п Транзистор Дарлингтона
dPNP	р-п-р Транзистор Дарлингтона
D-NPN	«цифровой» транзистор, т.е. в корпусе помимо самого транзистора находятся один или несколько резисторов. Традиционные способы проверки неисправности могут не подойти.
D-PNP	«цифровой» транзистор

Сокр-ние	Полное название фирмы
DTV	Диод для переключения диапазонов телевизионного приемника
DZ	Стабилитрон
FD	Быстродействующий диод
FID	Быстродействующий импульсный диод
FRD	Быстровосстанавливающийся выпрямительный диод
NPN	п-р-п транзистор
PD	Несимметричный динистор для защиты оборудования связи
PIN	р-і-п диод
PNP	р-п-р транзистор
PZ	Защитный стабилитрон
SD	Импульсный переключающий диод
SHD	Диод Шоттки
SHY	Выпрямительный диод Шоттки
SPD	Симметричный динистор для защиты оборудования связи
SPZ	Симметричный защитный стабилитрон
VAR	варикал
VD	Монитор напряжения (детектор напряжения)
VS	Подавитель выбросов напряжения (супрессор)

Список
сокращений и аббревиатур в графе «Особенности»

Сокр-ние	Полное название фирмы
C_{2V}	Ёмкость при напряжении на варикале 2В
C_{2V}/C_{30V}	Отношение ёмкостей для различных напряжений
C_D	Ёмкость диода
C_T	Суммарная ёмкость
f_T	Граничная частота
g_F	Прямая проводимость полевого транзистора
h_{21}	Статический коэффициент передачи тока
I_{cb0}	Обратный ток коллектор-база
I_c	Ток коллектора
I_D	Ток стока
I_{DSS}	Ток стока при нулевом потенциале на затворе
I_F	Прямой ток
I_T	Средний ток в состоянии включения
I_{jeak}	Ток утечки
I_R	Обратный ток
I_{ZM}	Максимальный ток стабилизации
I_{ZT}	Ток стабилизации в контрольной точке
I_{PP}	Пиковый импульсный ток разряда
I_Z	Ток стабилизации
L_T	Суммарная индуктивность
P_D	Рассеиваемая мощность

Сокр-ние	Полное название фирмы
R_{Dson}	Сопротивление канала в открытом состоянии
R_Z	Динамическое сопротивление
T_{cvz}	Температурный коэффициент напряжения стабилизации (Т Н)
T_{OFF}	Время выключения
t_{RR}	Время обратного восстановления
V_C	Напряжение фиксации (коллектора)
V_{CBO}	Обратное напряжение коллектор-база
V_{CEO}	Обратное напряжение коллектор-база
V_{cesat}	Напряжение насыщения коллектор-эмиттер
V_{DS}	Напряжение сток-исток
V_{GS}	Напряжение затвор-исток
V_{GSS}	Напряжение пробоя затвор-исток
V_F	Прямое напряжение
V_R	обратное напряжение
V_{BR}	Напряжение пробоя
V_{WM}	Напряжение выключения
V_Z	Напряжение стабилизации
Z_Z	Дифференциальное сопротивление
Z_{ZT}	Дифференциальное сопротивление в контрольной точке