

NO. OF CONTACTS	A MAX	B BSC	C MAX	D MAX	E MAX	F MAX JACKSCREW BODY STYLE #1 ONLY
9	.785	.565	.308	.310	.330	.400
15	.935	.715	.308	.310	.330	.550
21	1.085	.865	.308	.310	.330	.700
25	1.185	.965	.308	.310	.330	.800
31	1.335	1.115	.308	.310	.330	.950
37	1.485	1.265	.308	.310	.330	1.100
51	1.435	1.215	.351	.400	.345	1.045
69	1.735	1.515	.351	.400	.455	1.333
100	2.170	1.800	.394	.510	.400	1.550

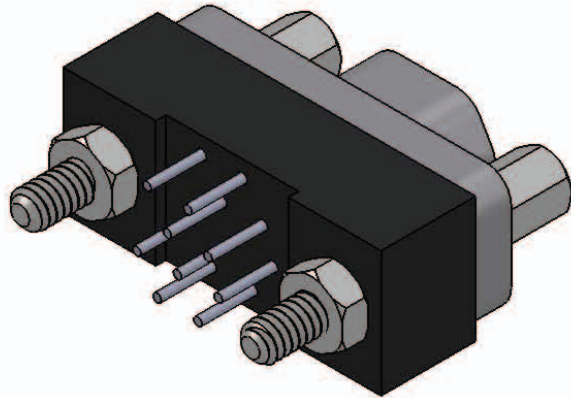

BACK VIEW

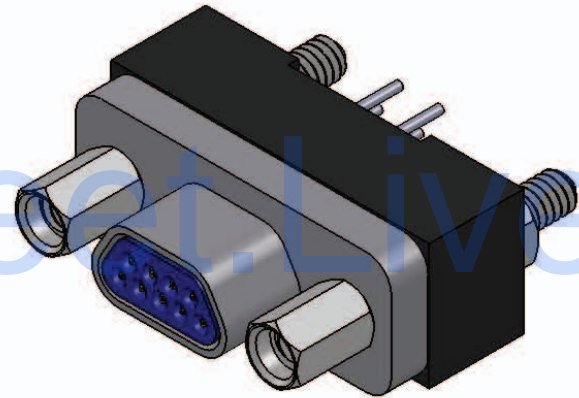
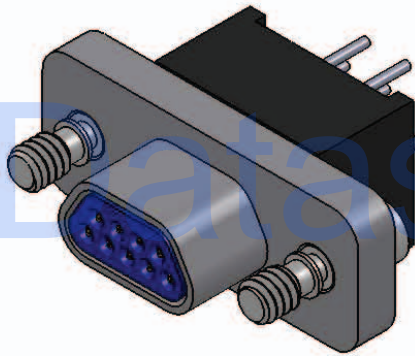

BODY STYLE #1

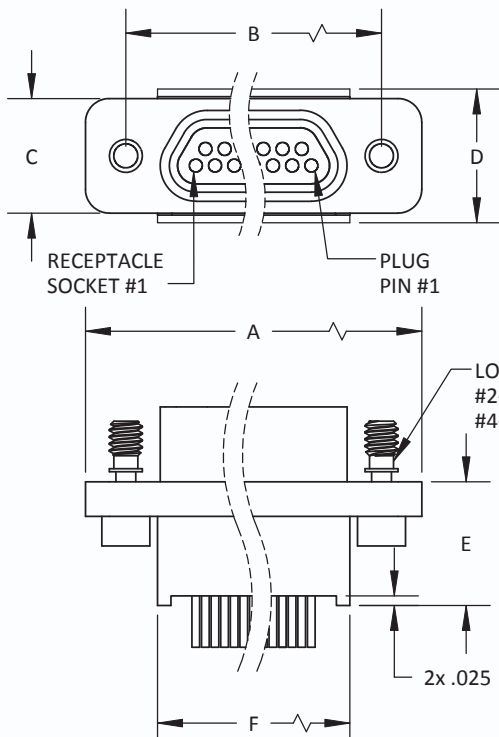

BODY STYLE #2

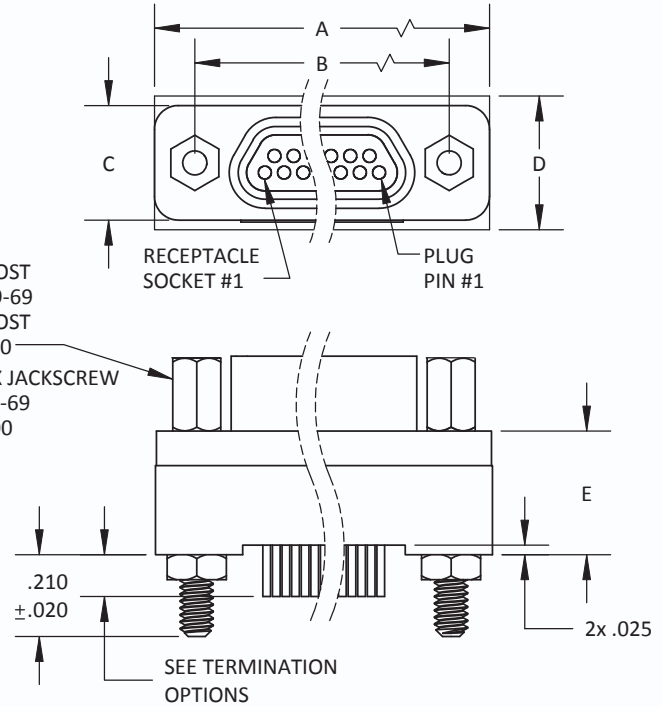

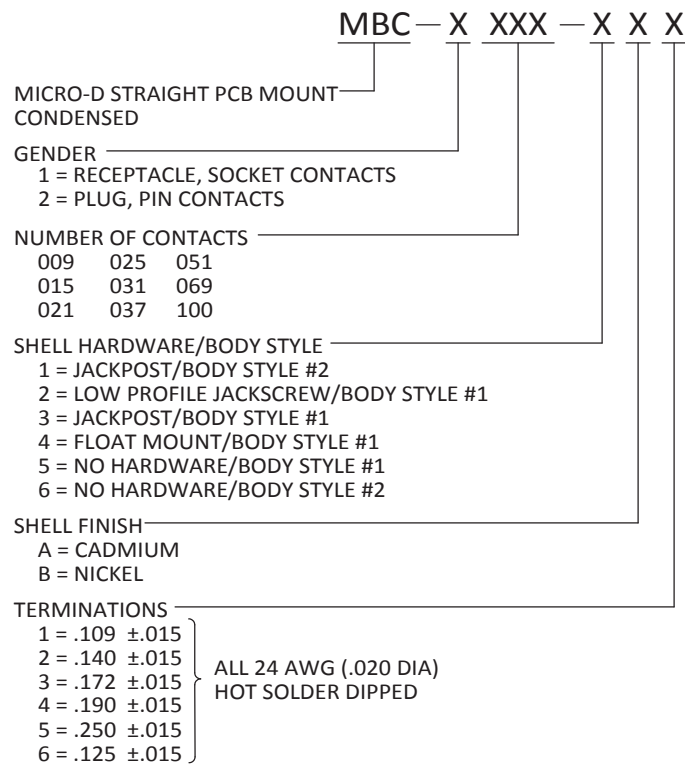

MATERIALS AND FINISHES ARE IAW MIL-DTL-83513  
FOR DETAILS SEE MIL SPEC OR WWW.CRISTEK.COM

**1. MATERIALS:**

SHELL - ALUMINUM ALLOY  
INSULATOR/BACKSHELL - GLASS FILLED THERMOPLASTIC  
PIN/SOCKET CONTACT - COPPER ALLOY  
INTERFACIAL SEAL - FLUOROSILICONE BLEND

**2. FINISH:**

SHELL - ELECTROLESS NICKEL OR CADMIUM  
OVER ELECTROLESS NICKEL  
PIN/SOCKET CONTACT - GOLD OVER NICKEL

**3. SPECIFICATIONS:**

CURRENT RATING ----- 3 AMPS MAX  
TEMPERATURE RATING ----- -55° C TO +125° C  
INSULATION RESISTANCE ----- 5000 MEGOHMS MIN  
DWV AT SEA LEVEL ----- 600 VAC  
DWV AT 70,000 FT ALTITUDE --- 150 VAC  
CONTACT RESISTANCE ----- 24 AWG = 25 MILLIOHMS MAX.  
CONTACT RETENTION ----- 5 lb MINIMUM AXIAL LOAD  
ENGAGEMENT FORCE ----- 6 oz MAX  
SEPARATION FORCE ----- 0.5 oz MIN

**4. ADDITIONAL INFORMATION:**

DESIGN AND PERFORMANCE IN GENERAL  
ACCORDANCE WITH M83513 WHERE APPLICABLE.  
CONTACT CRISTEK FOR OTHER CONFIGURATIONS.

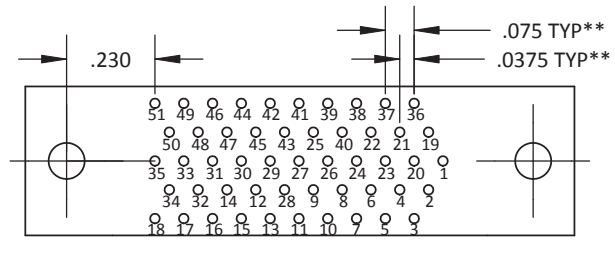
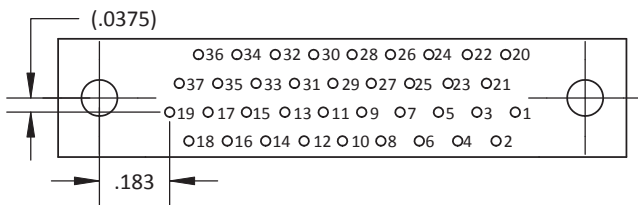
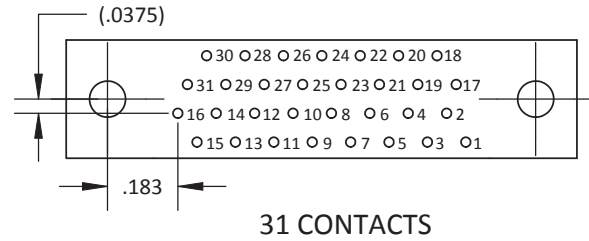
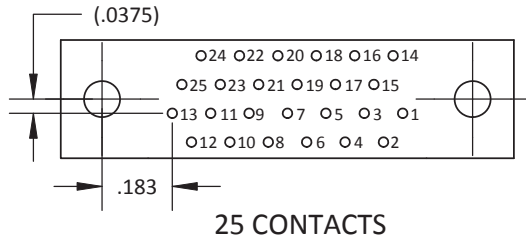
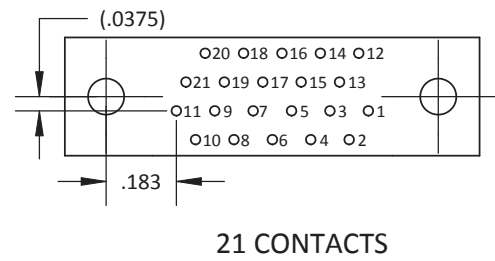
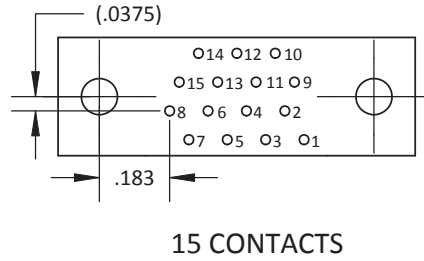
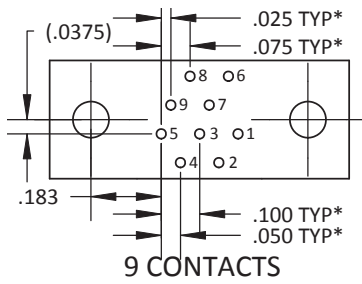

37 CONTACTS

51 CONTACTS

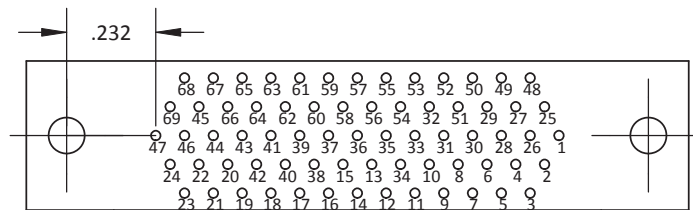

69 CONTACTS

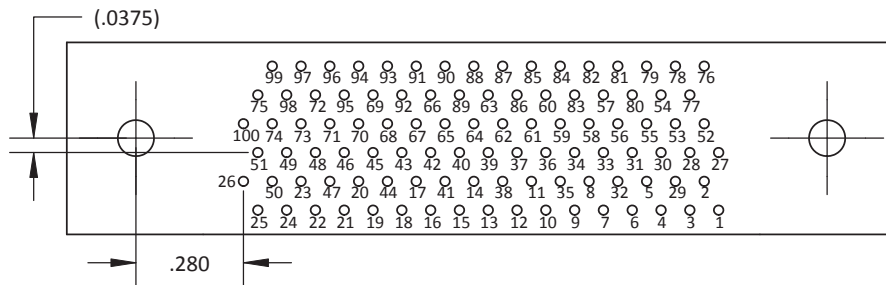

100 CONTACTS

**MBC PLUG PCB LAYOUTS**

\* SIZES 9-37: 0.100 X 0.075 GRID PATTERN OFFSET BY 0.050

\*\* SIZES 51-100: 0.075 X 0.075 GRID PATTERN OFFSET BY 0.0375

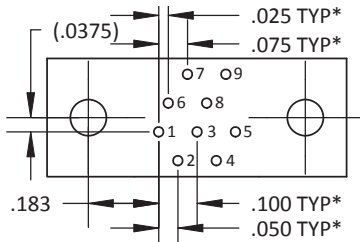

9 CONTACTS

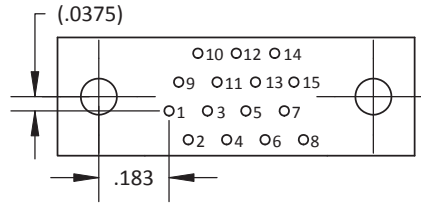

15 CONTACTS

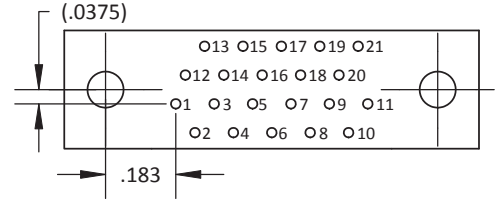

21 CONTACTS

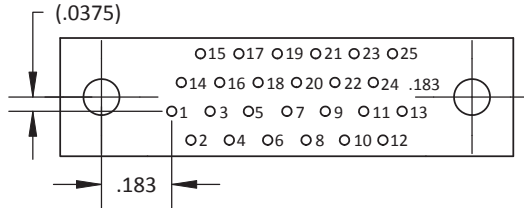

25 CONTACTS

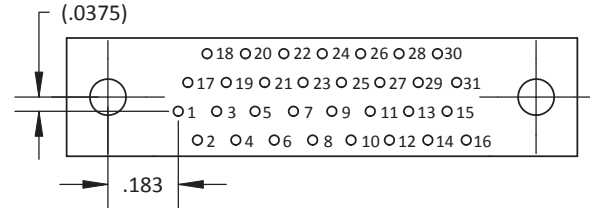

31 CONTACTS

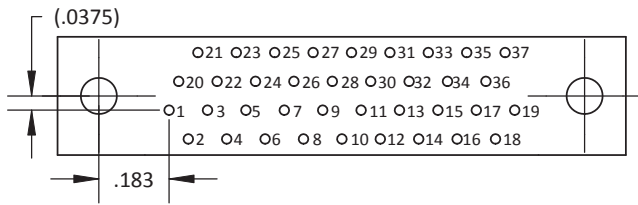

37 CONTACTS

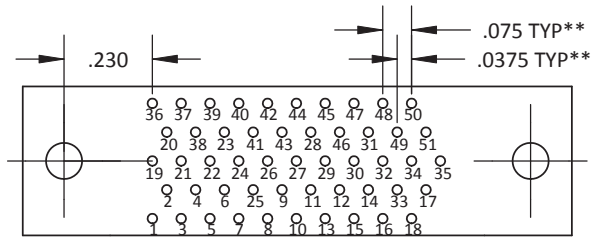

51 CONTACTS

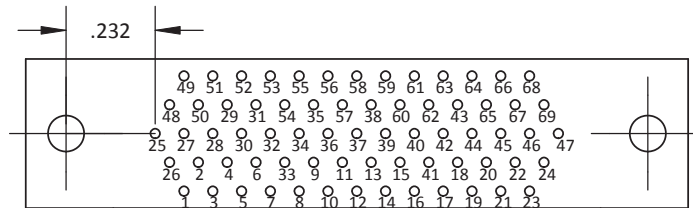

69 CONTACTS

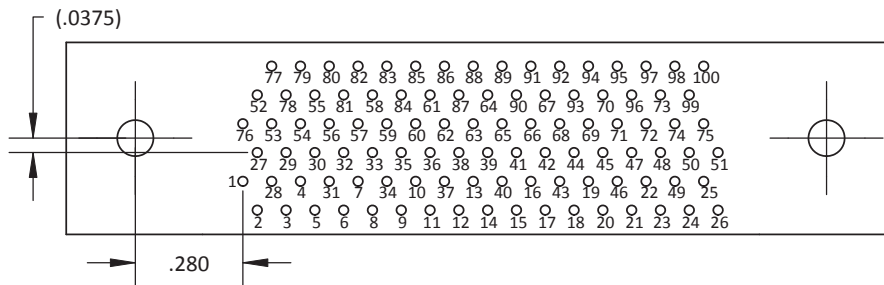

100 CONTACTS

**MBC RECEPTACLE PCB LAYOUTS**

\* SIZES 9-37: 0.100 X 0.075 GRID PATTERN OFFSET BY 0.050

\*\* SIZES 51-100: 0.075 X 0.075 GRID PATTERN OFFSET BY 0.0375