

GaAs PHEMT MMIC DRIVER AMPLIFIER, 18 - 40 GHz

Typical Applications

The HMC635LC4 is ideal for:

- Point-to-Point Radios
- Point-to-Multi-Point Radios & VSAT
- LO Driver for Mixers
- Military & Space

Features

- Gain: 18.5 dB ^[2]
- P1dB: +22 dBm ^[2]
- Output IP3: +27 dBm
- Saturated Power: +23.5 dBm @ 15% PAE ^[2]
- Supply Voltage: +5V @ 280 mA
- 50 Ohm Matched Input/Output
- 24 Lead Ceramic 4x4mm SMT Package: 16mm²

Functional Diagram

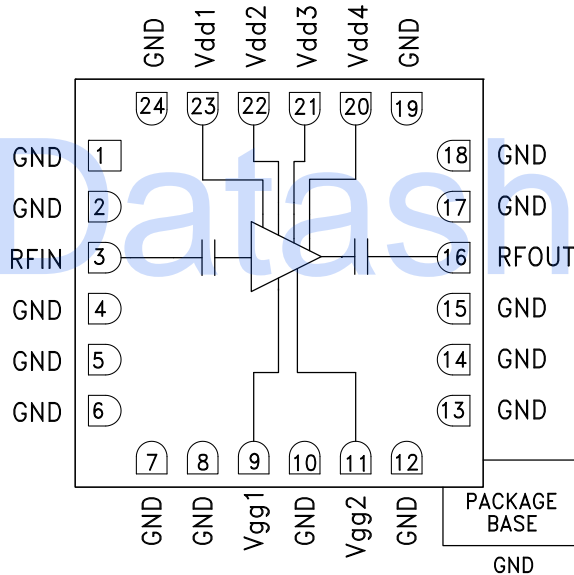

General Description

The HMC635LC4 is a GaAs PHEMT MMIC Driver Amplifier die which operates between 18 and 40 GHz. The amplifier provides 18.5 dB of gain, +27 dBm Output IP3, and +22 dBm of output power at 1 dB gain compression, while requiring 280 mA at a +5V supply. Ideal as a driver amplifier for microwave radio applications, or as an LO driver for mixers operating between 18 and 40 GHz, the HMC635LC4 is capable of providing up to +23.5 dBm of saturated output power at 15% PAE. The amplifier's I/Os are DC blocked and internally matched to 50 Ohms making it ideal for integration into Multi-Chip-Modules (MCMs).

Electrical Specifications

$$T_A = +25^\circ \text{C}, V_{dd} = V_{dd1}, 2, 3, 4 = +5\text{V}, I_{dd} = I_{dd1} + I_{dd2} + I_{dd3} + I_{dd4} = 280\text{mA} \text{ [1]}$$

| Parameter | Min. | Typ. | Max. | Min. | Typ. | Max. | Units | |
|---|---------|-------|---------|------|-------|------|--------|-----|
| Frequency Range | 18 - 36 | | 36 - 40 | | | | | GHz |
| Gain ^[2] | 15 | 18.5 | | 15 | 17.5 | | dB | |
| Gain Variation Over Temperature | | 0.045 | 0.06 | | 0.045 | 0.06 | dB/ °C | |
| Input Return Loss | | 13 | | | 7 | | dB | |
| Output Return Loss | | 10 | | | 7 | | dB | |
| Output Power for 1 dB Compression (P1dB) ^[2] | 19 | 22 | | 16 | 21 | | dBm | |
| Saturated Output Power (P _{sat}) ^[2] | | 23.5 | | | 21.5 | | dBm | |
| Output Third Order Intercept (IP3) | 22 | 27 | | 21 | 26 | | dBm | |
| Noise Figure ^[2] | | 7 | | | 7 | | dB | |
| Total Supply Current (I _{dd1} + I _{dd2} + I _{dd3} + I _{dd4}) | | 280 | | | 280 | | mA | |

[1] Adjust V_{gg1} = V_{gg2} between -2 to 0V to achieve I_{dd} = 280 mA Typical.

[2] Board loss subtracted out for gain, power and noise figure measurements.

GaAs PHEMT MMIC DRIVER AMPLIFIER, 18 - 40 GHz

Broadband Gain & Return Loss [1]

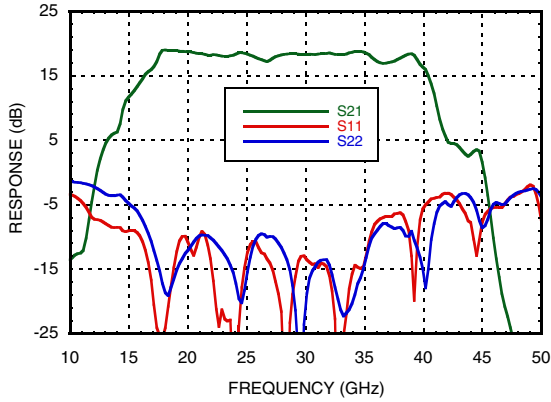

Gain vs. Temperature [1]

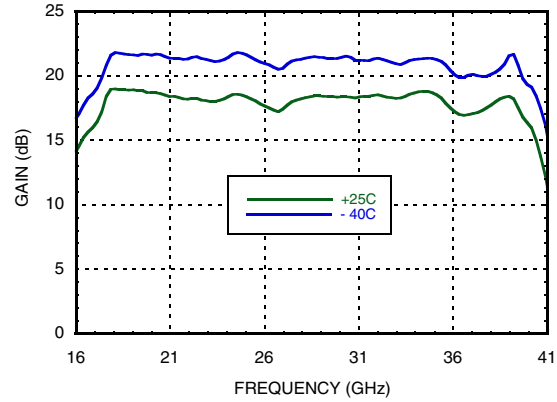

Input Return Loss vs. Temperature

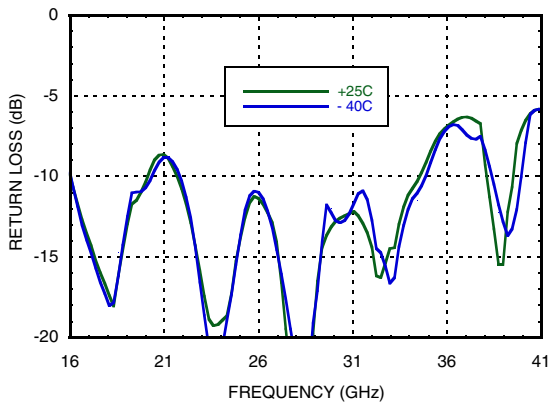

Output Return Loss vs. Temperature

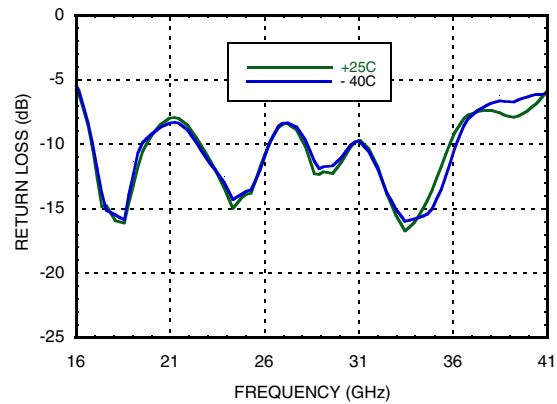

P1dB vs. Temperature [1]

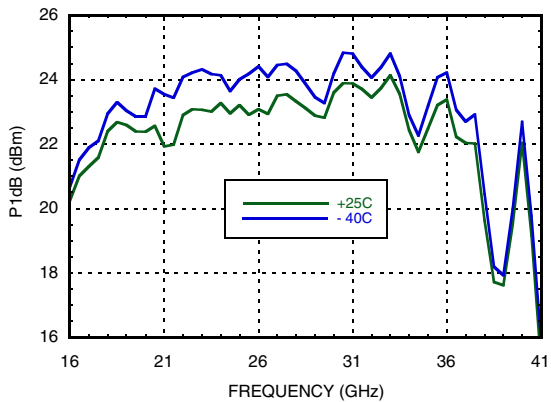

Psat vs. Temperature [1]

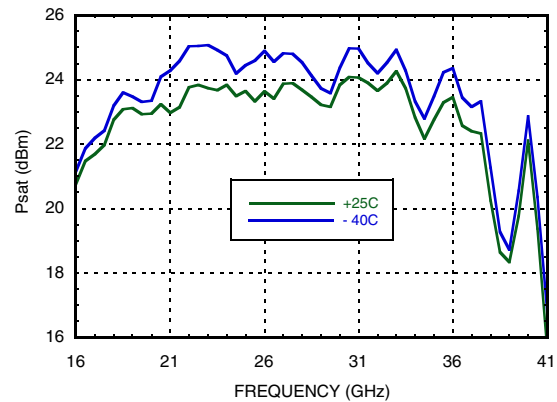

[1] Board loss subtracted out for gain, power and noise figure measurements.

GaAs PHEMT MMIC DRIVER AMPLIFIER, 18 - 40 GHz

Power Compression @ 30 GHz [1]

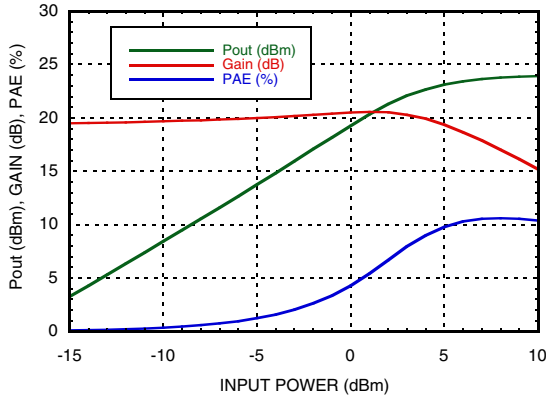

Power Compression @ 40 GHz [1]

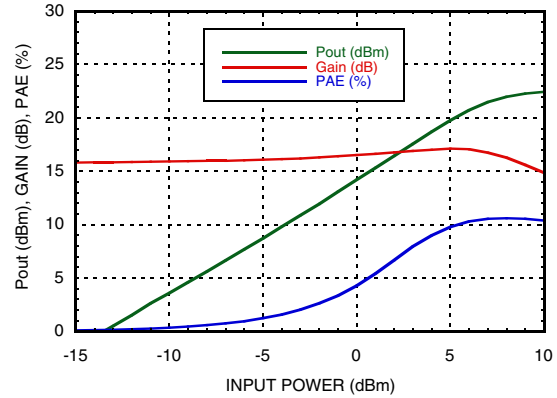

Output IP3 vs. Temperature

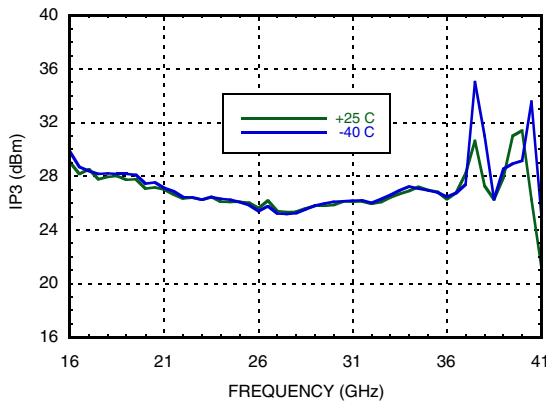

Noise Figure vs. Temperature [1]

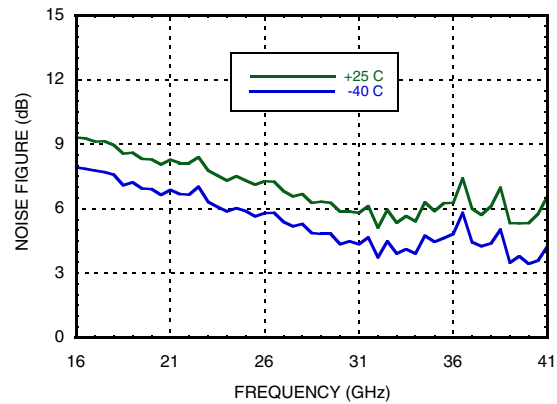

Gain & Power vs. Supply Voltage @ 30 GHz [1]

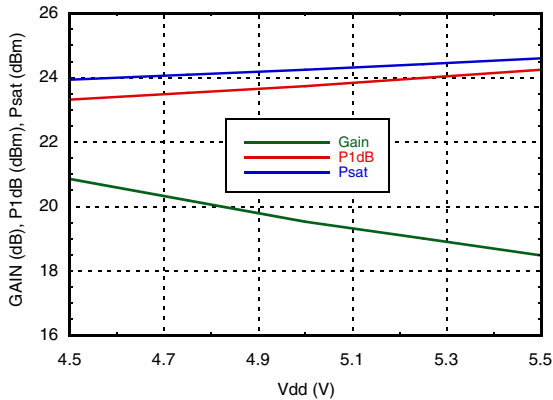

Reverse Isolation vs. Temperature

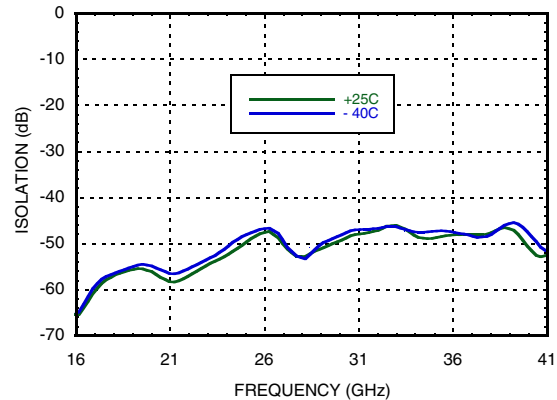

[1] Board loss subtracted out for gain, power and noise figure measurements.

GaAs PHEMT MMIC DRIVER AMPLIFIER, 18 - 40 GHz

Absolute Maximum Ratings

| | |
|--|----------------|
| Drain Bias Voltage (Vdd1, 2, 3, 4) | +5.5V |
| Gate Bias Voltage (Vgg1, Vgg2) | -3 to 0V |
| RF Input Power (RFIN)(Vdd = +5 Vdc) | 15 dBm |
| Channel Temperature | 175 °C |
| Continuous Pdiss (T= 70 °C) (derate 15.1 mW/°C above 70 °C) | 1.575 W |
| Thermal Resistance (channel to package base) | 66.4 °C/W |
| Storage Temperature | -65 to +150 °C |
| Operating Temperature | -55 to +85 °C |

Typical Supply Current vs. Vdd

| Vdd (V) | Idd (mA) |
|---------|----------|
| 4.5 | 277 |
| 5.0 | 280 |
| 5.5 | 286 |

Note: Amplifier will operate over full voltage ranges shown above



**ELECTROSTATIC SENSITIVE DEVICE
OBSERVE HANDLING PRECAUTIONS**

Outline Drawing

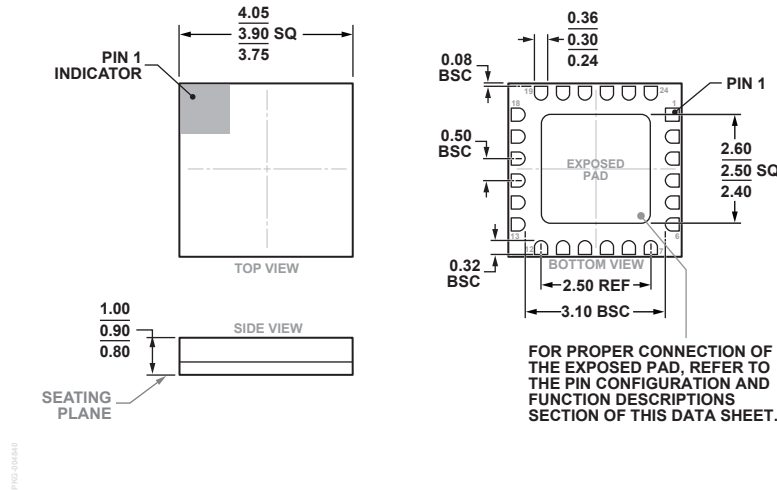

24-Terminal Ceramic Leadless Chip Carrier [LCC]
(E-24-1)
Dimensions shown in millimeters.

Package Information

| Part Number | Package Body Material | Lead Finish | MSL Rating | Package Marking ^[2] |
|-------------|-----------------------|------------------|---------------------|--------------------------------|
| HMC635LC4 | Alumina, White | Gold over Nickel | MSL3 ^[1] | H635 XXXX |

[1] Max peak reflow temperature of 260 °C

[2] 4-Digit lot number XXXX

GaAs PHEMT MMIC DRIVER AMPLIFIER, 18 - 40 GHz

Pin Descriptions

| Pin Number | Function | Description | Interface Schematic |
|--|-------------|---|---------------------|
| 1, 2, 4 - 8, 10, 12 - 15, 17 - 19, 24, Ground Paddle | GND | These pins and package bottom must be connected to RF/DC ground | |
| 3 | RFIN | This pad is AC coupled and matched to 50 Ohms. | |
| 16 | RFOUT | This pad is AC coupled and matched to 50 Ohms. | |
| 9, 11 | Vgg1, Vgg2 | Gate control for amplifier, please follow "MMIC Amplifier Biasing Procedure" application note. See assembly diagram for required external components. | |
| 20 - 23 | Vdd4 - Vdd1 | Power Supply Voltage for the amplifier. See assembly diagram for required external components. | |

Application Circuit

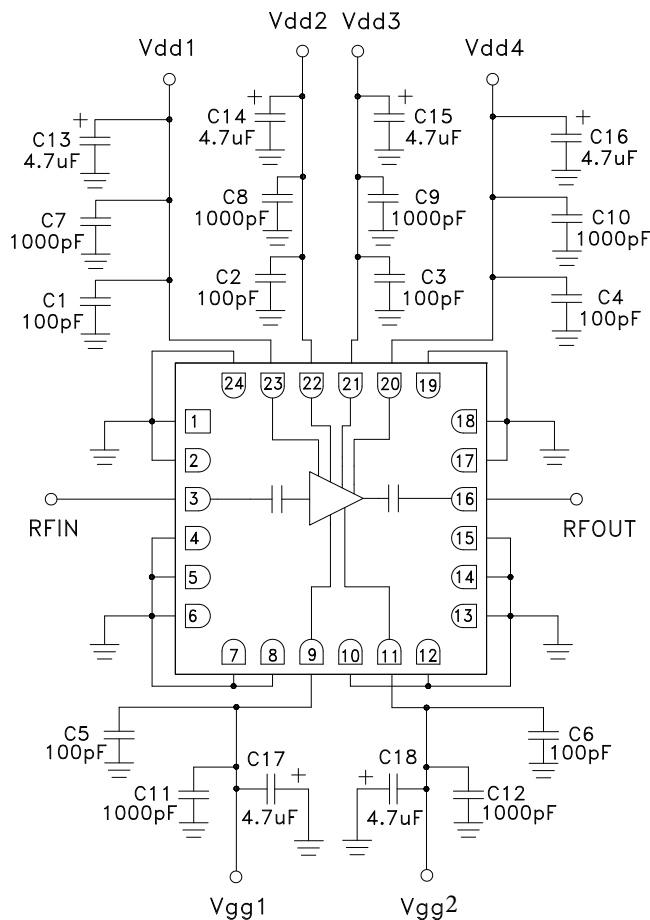

GaAs PHEMT MMIC DRIVER AMPLIFIER, 18 - 40 GHz

Evaluation PCB

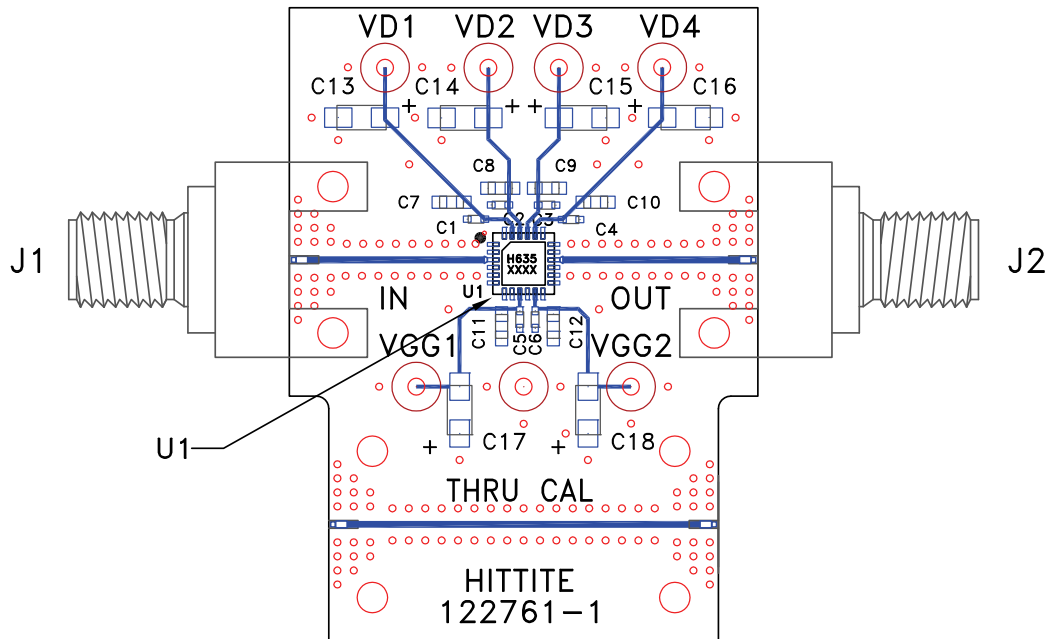

List of Materials for Evaluation 122763 ^[1]

| Item | Description |
|--------------------------|--------------------------------------|
| J1 - J2 | 2.92 mm PC Mount K-Connector |
| VD1 - VD4, VGG1, VGG2 | DC Pin |
| C1 - C6 | 100 pF Capacitor, 0402 Pkg. |
| C7 - C12 | 1000 pF Capacitor, 0603 Pkg. |
| C13 - C18 | 4.7 μF Capacitor, Tantalum, Case A |
| U1 | HMC635LC4 Driver Amplifier |
| PCB ^[2] | 122761 Evaluation PCB ^[3] |

[1] Reference this number when ordering complete evaluation PCB

[2] Circuit Board Material: Rogers 4350 or Arlon 25FR

[3] Due to the very high frequency operation of this product a custom LC4 PCB footprint and solder stencil are required for this design. Performance shown in this data sheet was produced using this custom footprint. DO NOT USE Hittite's standard LC4 footprint. Please contact Applications for details.

The circuit board used in the application should use RF circuit design techniques. Signal lines should have 50 Ohm impedance while the package ground leads and exposed paddle should be connected directly to the ground plane similar to that shown. A sufficient number of via holes should be used to connect the top and bottom ground planes. The evaluation board should be mounted to an appropriate heat sink. The evaluation circuit board shown is available from Analog Devices upon request.

Mouser Electronics

Authorized Distributor

Click to View Pricing, Inventory, Delivery & Lifecycle Information:

[Analog Devices Inc.:](#)

[HMC635LC4](#) [HMC635LC4TR](#) [122763-HMC635LC4](#)