

# TIP41, TIP41A, TIP41B, TIP41C (NPN); TIP42, TIP42A, TIP42B, TIP42C (PNP)



ON Semiconductor®

<http://onsemi.com>

## Complementary Silicon Plastic Power Transistors

Designed for use in general purpose amplifier and switching applications.

### Features

- ESD Ratings: Machine Model, C; > 400 V  
Human Body Model, 3B; > 8000 V
- Epoxy Meets UL 94 V-0 @ 0.125 in
- Pb-Free Packages are Available\*

### MAXIMUM RATINGS

Rating	Symbol	Value	Unit
Collector-Emitter Voltage TIP41, TIP42 TIP41A, TIP42A TIP41B, TIP42B TIP41C, TIP42C	$V_{CEO}$	40 60 80 100	Vdc
Collector-Base Voltage TIP41, TIP42 TIP41A, TIP42A TIP41B, TIP42B TIP41C, TIP42C	$V_{CB}$	40 60 80 100	Vdc
Emitter-Base Voltage	$V_{EB}$	5.0	Vdc
Collector Current- Continuous Peak	$I_C$	6.0 10	Adc
Base Current	$I_B$	2.0	Adc
Total Power Dissipation @ $T_C = 25^\circ\text{C}$ Derate above $25^\circ\text{C}$	$P_D$	65 0.52	W W/ $^\circ\text{C}$
Total Power Dissipation @ $T_A = 25^\circ\text{C}$ Derate above $25^\circ\text{C}$	$P_D$	2.0 0.016	W W/ $^\circ\text{C}$
Unclamped Inductive Load Energy (Note 1)	E	62.5	mJ
Operating and Storage Junction, Temperature Range	$T_J, T_{stg}$	-65 to +150	$^\circ\text{C}$

### THERMAL CHARACTERISTICS

Characteristic	Symbol	Max	Unit
Thermal Resistance, Junction-to-Case	$R_{\theta JC}$	1.67	$^\circ\text{C}/\text{W}$
Thermal Resistance, Junction-to-Ambient	$R_{\theta JA}$	57	$^\circ\text{C}/\text{W}$

Stresses exceeding Maximum Ratings may damage the device. Maximum Ratings are stress ratings only. Functional operation above the Recommended Operating Conditions is not implied. Extended exposure to stresses above the Recommended Operating Conditions may affect device reliability.

1.  $I_C = 2.5\text{ A}$ ,  $L = 20\text{ mH}$ , P.R.F. = 10 Hz,  $V_{CC} = 10\text{ V}$ ,  $R_{BE} = 100\ \Omega$ .

\*For additional information on our Pb-Free strategy and soldering details, please download the ON Semiconductor Soldering and Mounting Techniques Reference Manual, SOLDERRM/D.

## 6 AMPERE COMPLEMENTARY SILICON POWER TRANSISTORS 40-60-80-100 VOLTS, 65 WATTS

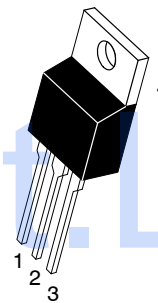

### MARKING DIAGRAM

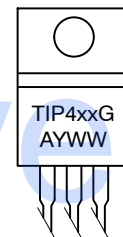

TO-220AB  
CASE 221A  
STYLE 1

STYLE 1:  
PIN 1. BASE  
2. COLLECTOR  
3. EMITTER  
4. COLLECTOR

TIP4xx = Device Code  
xx = 1, 1A, 1B, 1C  
2, 2A, 2B, 2C  
A = Assembly Location  
Y = Year  
WW = Work Week  
G = Pb-Free Package

### ORDERING INFORMATION

See detailed ordering and shipping information in the package dimensions section on page 3 of this data sheet.

# TIP41, TIP41A, TIP41B, TIP41C (NPN); TIP42, TIP42A, TIP42B, TIP42C (PNP)

## ELECTRICAL CHARACTERISTICS ( $T_C = 25^\circ\text{C}$ unless otherwise noted)

Characteristic	Symbol	Min	Max	Unit	
<b>OFF CHARACTERISTICS</b>					
Collector–Emitter Sustaining Voltage (Note 2) ( $I_C = 30\text{ mA}$ , $I_B = 0$ )	TIP41, TIP42 TIP41A, TIP42A TIP41B, TIP42B TIP41C, TIP42C	$V_{CE(sus)}$	40 60 80 100	– – – –	Vdc
Collector Cutoff Current ( $V_{CE} = 30\text{ Vdc}$ , $I_B = 0$ ) ( $V_{CE} = 60\text{ Vdc}$ , $I_B = 0$ )	TIP41, TIP41A, TIP42, TIP42A TIP41B, TIP41C, TIP42B, TIP42C	$I_{CEO}$	– –	0.7 0.7	mAdc
Collector Cutoff Current ( $V_{CE} = 40\text{ Vdc}$ , $V_{EB} = 0$ ) ( $V_{CE} = 60\text{ Vdc}$ , $V_{EB} = 0$ ) ( $V_{CE} = 80\text{ Vdc}$ , $V_{EB} = 0$ ) ( $V_{CE} = 100\text{ Vdc}$ , $V_{EB} = 0$ )	TIP41, TIP42 TIP41A, TIP42A TIP41B, TIP42B TIP41C, TIP42C	$I_{CES}$	– – – –	400 400 400 400	$\mu\text{Adc}$
Emitter Cutoff Current ( $V_{BE} = 5.0\text{ Vdc}$ , $I_C = 0$ )		$I_{EBO}$	–	1.0	mAdc
<b>ON CHARACTERISTICS (Note 2)</b>					
DC Current Gain ( $I_C = 0.3\text{ Adc}$ , $V_{CE} = 4.0\text{ Vdc}$ ) ( $I_C = 3.0\text{ Adc}$ , $V_{CE} = 4.0\text{ Vdc}$ )		$h_{FE}$	30 15	– 75	–
Collector–Emitter Saturation Voltage ( $I_C = 6.0\text{ Adc}$ , $I_B = 600\text{ mA}$ )		$V_{CE(sat)}$	–	1.5	Vdc
Base–Emitter On Voltage ( $I_C = 6.0\text{ Adc}$ , $V_{CE} = 4.0\text{ Vdc}$ )		$V_{BE(on)}$	–	2.0	Vdc
<b>DYNAMIC CHARACTERISTICS</b>					
Current–Gain — Bandwidth Product ( $I_C = 500\text{ mA}$ , $V_{CE} = 10\text{ Vdc}$ , $f_{test} = 1.0\text{ MHz}$ )		$f_T$	3.0	–	MHz
Small–Signal Current Gain ( $I_C = 0.5\text{ Adc}$ , $V_{CE} = 10\text{ Vdc}$ , $f = 1.0\text{ kHz}$ )		$h_{fe}$	20	–	–

2. Pulse Test: Pulse Width  $\leq 300\ \mu\text{s}$ , Duty Cycle  $\leq 2.0\%$ .

# TIP41, TIP41A, TIP41B, TIP41C (NPN); TIP42, TIP42A, TIP42B, TIP42C (PNP)



Figure 1. Darlington Circuit Schematic

## ORDERING INFORMATION

Device	Package	Shipping
TIP41	TO-220	50 Units / Rail
TIP41G	TO-220 (Pb-Free)	50 Units / Rail
TIP41A	TO-220	50 Units / Rail
TIP41AG	TO-220 (Pb-Free)	50 Units / Rail
TIP41B	TO-220	50 Units / Rail
TIP41BG	TO-220 (Pb-Free)	50 Units / Rail
TIP41C	TO-220	50 Units / Rail
TIP41CG	TO-220 (Pb-Free)	50 Units / Rail
TIP42	TO-220	50 Units / Rail
TIP42G	TO-220 (Pb-Free)	50 Units / Rail
TIP42A	TO-220	50 Units / Rail
TIP42AG	TO-220 (Pb-Free)	50 Units / Rail
TIP42B	TO-220	50 Units / Rail
TIP42BG	TO-220 (Pb-Free)	50 Units / Rail
TIP42C	TO-220	50 Units / Rail
TIP42CG	TO-220 (Pb-Free)	50 Units / Rail

TIP41, TIP41A, TIP41B, TIP41C (NPN); TIP42, TIP42A, TIP42B, TIP42C (PNP)

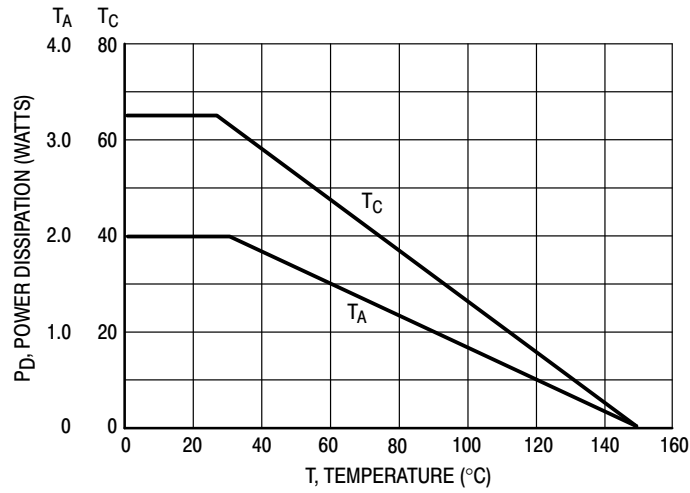

Figure 2. Power Derating

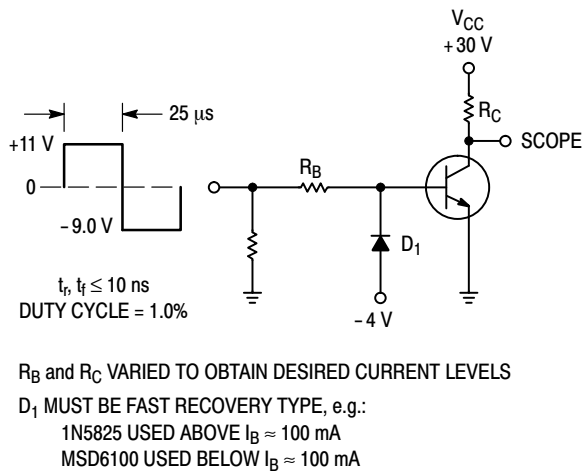

Figure 3. Switching Time Test Circuit

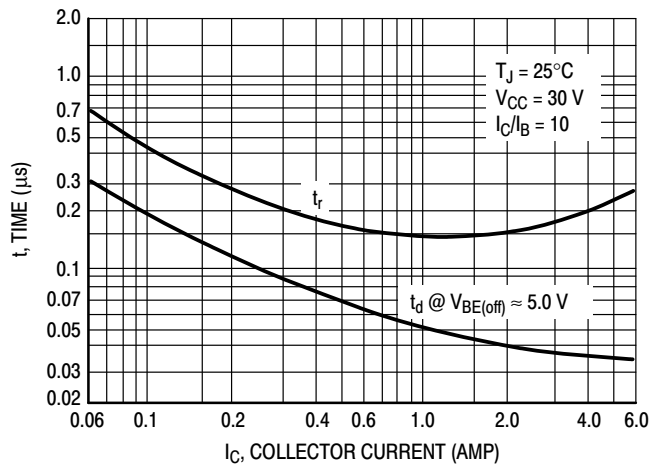

Figure 4. Turn-On Time

TIP41, TIP41A, TIP41B, TIP41C (NPN); TIP42, TIP42A, TIP42B, TIP42C (PNP)

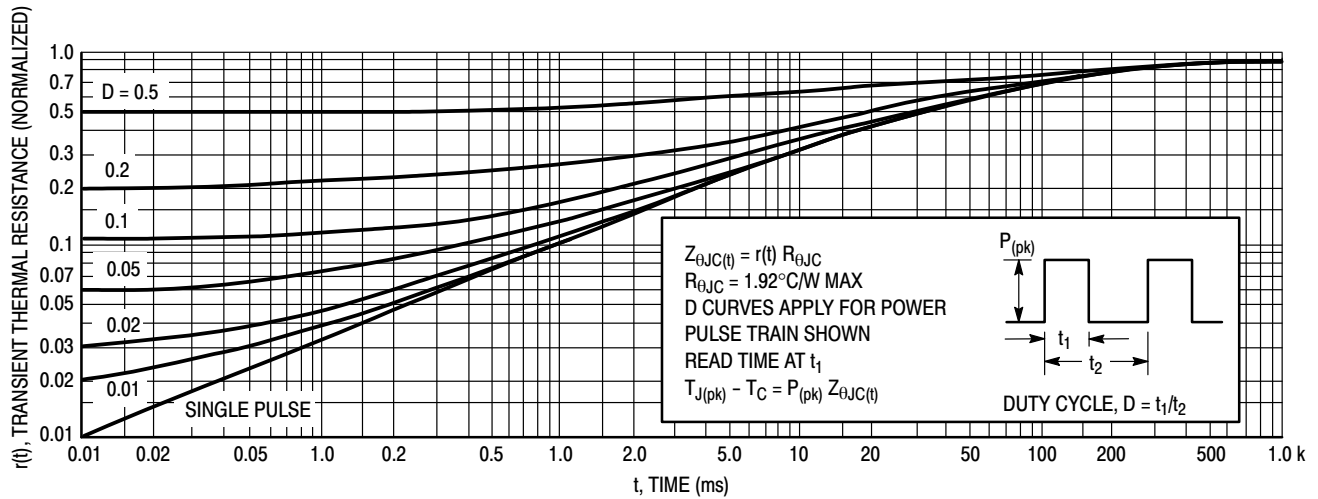

Figure 5. Thermal Response

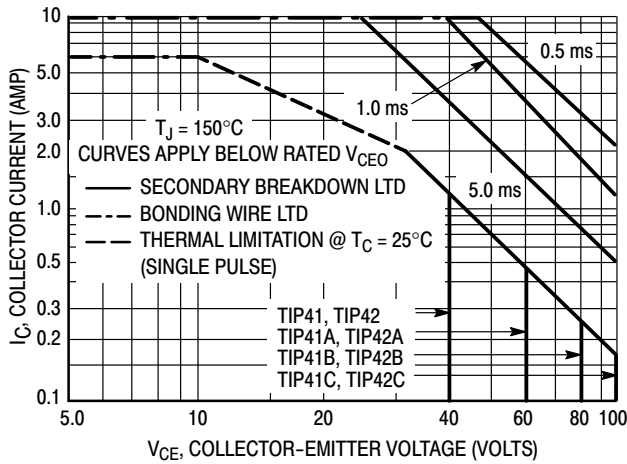

Figure 6. Active-Region Safe Operating Area

There are two limitations on the power handling ability of a transistor: average junction temperature and second breakdown. Safe operating area curves indicate  $I_C - V_{CE}$  limits of the transistor that must be observed for reliable operation; i.e., the transistor must not be subjected to greater dissipation than the curves indicate.

The data of Figure 6 is based on  $T_{J(pk)} = 150^{\circ}\text{C}$ ;  $T_C$  is variable depending on conditions. Second breakdown pulse limits are valid for duty cycles to 10% provided  $T_{J(pk)} \leq 150^{\circ}\text{C}$ .  $T_{J(pk)}$  may be calculated from the data in Figure 5. At high case temperatures, thermal limitations will reduce the power that can be handled to values less than the limitations imposed by second breakdown.

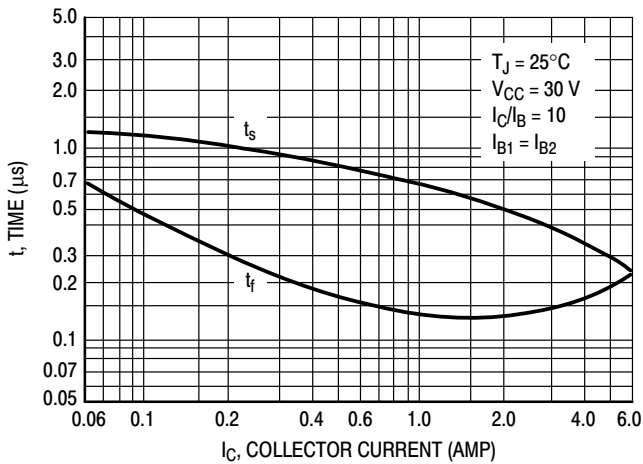

Figure 7. Turn-Off Time

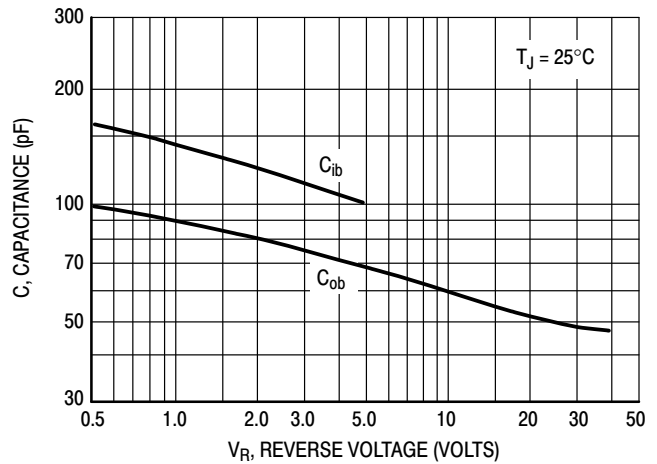

Figure 8. Capacitance

TIP41, TIP41A, TIP41B, TIP41C (NPN); TIP42, TIP42A, TIP42B, TIP42C (PNP)

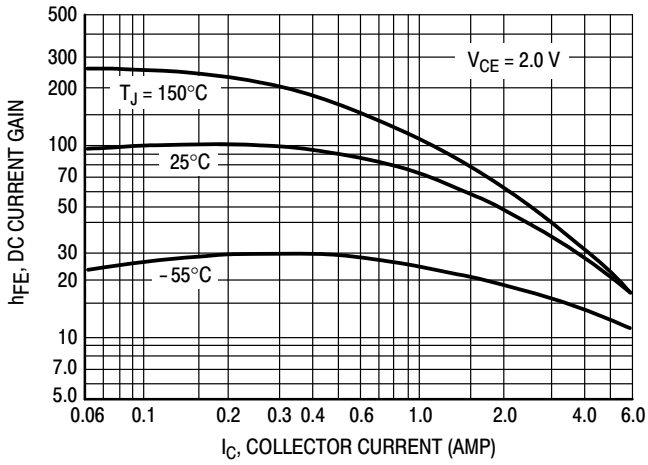

Figure 9. DC Current Gain

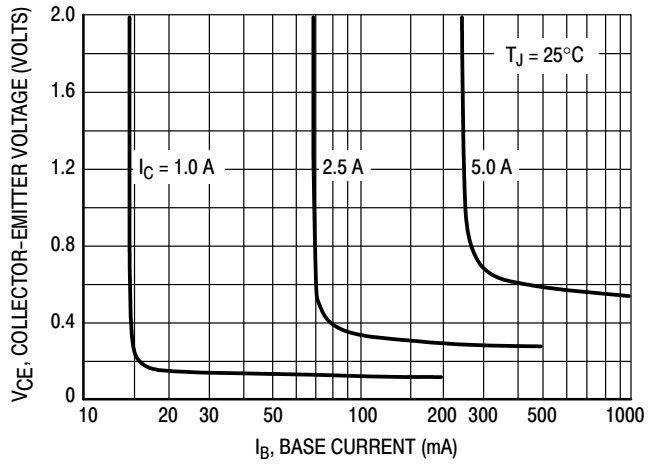

Figure 10. Collector Saturation Region

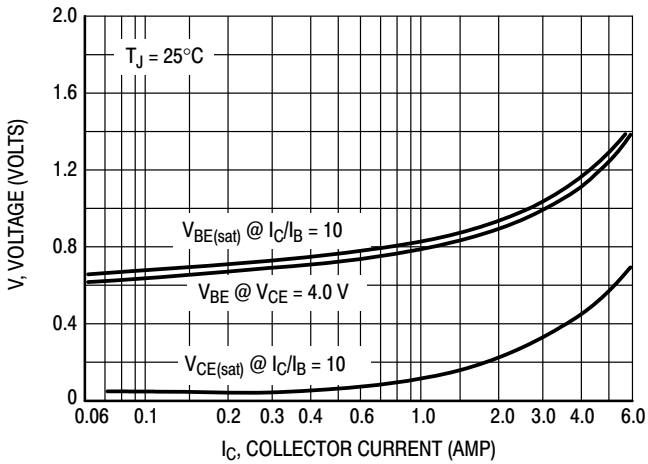

Figure 11. "On" Voltages

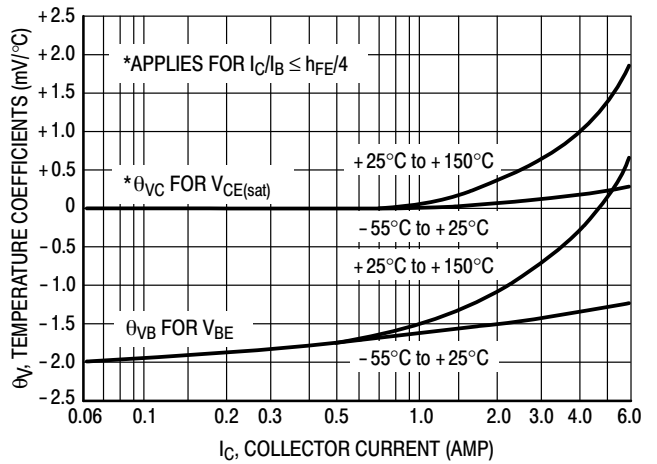

Figure 12. Temperature Coefficients

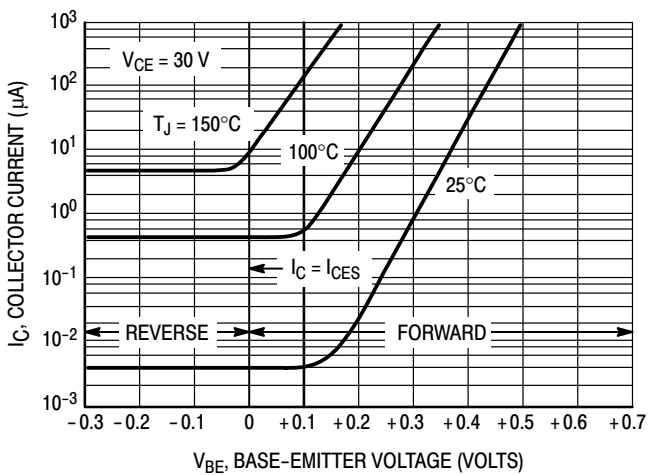

Figure 13. Collector Cut-Off Region

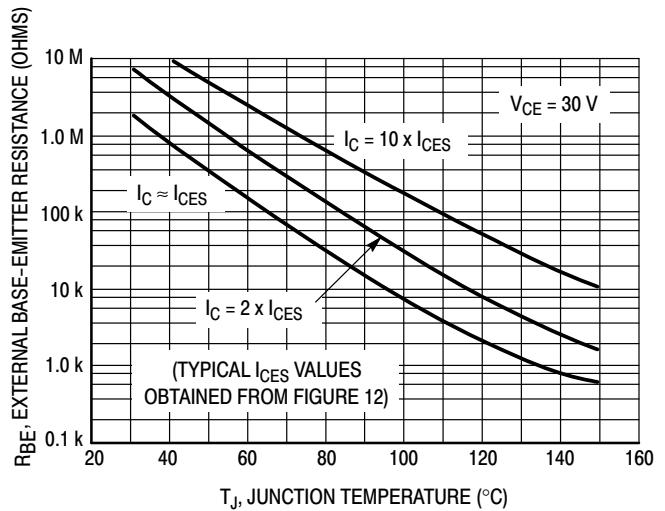
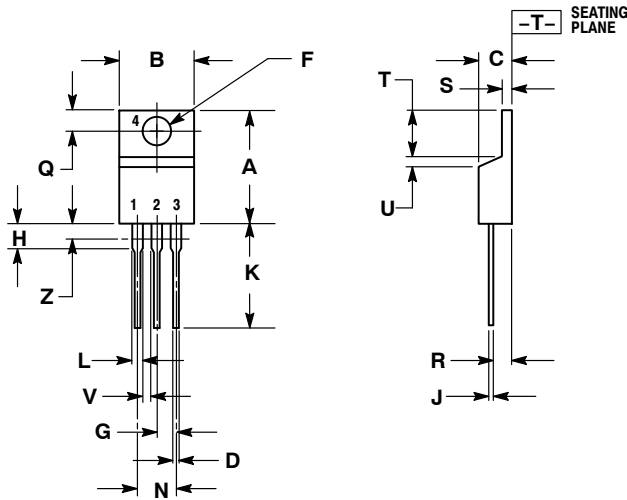

Figure 14. Effects of Base-Emitter Resistance

# TIP41, TIP41A, TIP41B, TIP41C (NPN); TIP42, TIP42A, TIP42B, TIP42C (PNP)

## PACKAGE DIMENSIONS

### TO-220 CASE 221A-09 ISSUE AG



- NOTES:
1. DIMENSIONING AND TOLERANCING PER ANSI Y14.5M, 1982.
  2. CONTROLLING DIMENSION: INCH.
  3. DIMENSION Z DEFINES A ZONE WHERE ALL BODY AND LEAD IRREGULARITIES ARE ALLOWED.

DIM	INCHES		MILLIMETERS	
	MIN	MAX	MIN	MAX
A	0.570	0.620	14.48	15.75
B	0.380	0.405	9.66	10.28
C	0.160	0.190	4.07	4.82
D	0.025	0.036	0.64	0.91
F	0.142	0.161	3.61	4.09
G	0.095	0.105	2.42	2.66
H	0.110	0.161	2.80	4.10
J	0.014	0.025	0.36	0.64
K	0.500	0.562	12.70	14.27
L	0.045	0.060	1.15	1.52
N	0.190	0.210	4.83	5.33
Q	0.100	0.120	2.54	3.04
R	0.080	0.110	2.04	2.79
S	0.045	0.055	1.15	1.39
T	0.235	0.255	5.97	6.47
U	0.000	0.050	0.00	1.27
V	0.045	---	1.15	---
Z	---	0.080	---	2.04

- STYLE 1:
1. BASE
  2. COLLECTOR
  3. EMITTER
  4. COLLECTOR

**ON Semiconductor** and **ON** are registered trademarks of Semiconductor Components Industries, LLC (SCILLC). SCILLC reserves the right to make changes without further notice to any products herein. SCILLC makes no warranty, representation or guarantee regarding the suitability of its products for any particular purpose, nor does SCILLC assume any liability arising out of the application or use of any product or circuit, and specifically disclaims any and all liability, including without limitation special, consequential or incidental damages. "Typical" parameters which may be provided in SCILLC data sheets and/or specifications can and do vary in different applications and actual performance may vary over time. All operating parameters, including "Typicals" must be validated for each customer application by customer's technical experts. SCILLC does not convey any license under its patent rights nor the rights of others. SCILLC products are not designed, intended, or authorized for use as components in systems intended for surgical implant into the body, or other applications intended to support or sustain life, or for any other application in which the failure of the SCILLC product could create a situation where personal injury or death may occur. Should Buyer purchase or use SCILLC products for any such unintended or unauthorized application, Buyer shall indemnify and hold SCILLC and its officers, employees, subsidiaries, affiliates, and distributors harmless against all claims, costs, damages, and expenses, and reasonable attorney fees arising out of, directly or indirectly, any claim of personal injury or death associated with such unintended or unauthorized use, even if such claim alleges that SCILLC was negligent regarding the design or manufacture of the part. SCILLC is an Equal Opportunity/Affirmative Action Employer. This literature is subject to all applicable copyright laws and is not for resale in any manner.

### PUBLICATION ORDERING INFORMATION

**LITERATURE FULFILLMENT:**  
Literature Distribution Center for ON Semiconductor  
P.O. Box 5163, Denver, Colorado 80217 USA  
**Phone:** 303-675-2175 or 800-344-3860 Toll Free USA/Canada  
**Fax:** 303-675-2176 or 800-344-3867 Toll Free USA/Canada  
**Email:** orderlit@onsemi.com

**N. American Technical Support:** 800-282-9855 Toll Free  
USA/Canada  
**Europe, Middle East and Africa Technical Support:**  
Phone: 421 33 790 2910  
**Japan Customer Focus Center**  
Phone: 81-3-5773-3850

**ON Semiconductor Website:** [www.onsemi.com](http://www.onsemi.com)  
**Order Literature:** <http://www.onsemi.com/orderlit>  
For additional information, please contact your local  
Sales Representative