

BC846ALT1G Series, SBC846ALT1G Series



ON Semiconductor®

<http://onsemi.com>

General Purpose Transistors

NPN Silicon

Features

- Moisture Sensitivity Level: 1
- ESD Rating – Human Body Model: >4000 V
– Machine Model: >400 V
- AEC-Q101 Qualified and PPAP Capable
- S Prefix for Automotive and Other Applications Requiring Unique Site and Control Change Requirements
- These Devices are Pb-Free, Halogen Free/BFR Free and are RoHS Compliant

MAXIMUM RATINGS

Rating	Symbol	Value	Unit
Collector-Emitter Voltage BC846, SBC846 BC847, BC850, SBC847 BC848, BC849, SBC848	V_{CEO}	65 45 30	Vdc
Collector-Base Voltage BC846, SBC846 BC847, BC850, SBC847 BC848, BC849, SBC848	V_{CBO}	80 50 30	Vdc
Emitter-Base Voltage BC846, SBC846 BC847, BC850, SBC847 BC848, BC849, SBC848	V_{EBO}	6.0 6.0 5.0	Vdc
Collector Current – Continuous	I_C	100	mAdc

Stresses exceeding Maximum Ratings may damage the device. Maximum Ratings are stress ratings only. Functional operation above the Recommended Operating Conditions is not implied. Extended exposure to stresses above the Recommended Operating Conditions may affect device reliability.

THERMAL CHARACTERISTICS

Characteristic	Symbol	Max	Unit
Total Device Dissipation FR-5 Board, (Note 1) $T_A = 25^\circ\text{C}$ Derate above 25°C	P_D	225 1.8	mW mW/ $^\circ\text{C}$
Thermal Resistance, Junction-to-Ambient (Note 1)	$R_{\theta JA}$	556	$^\circ\text{C}/\text{W}$
Total Device Dissipation Alumina Substrate (Note 2) $T_A = 25^\circ\text{C}$ Derate above 25°C	P_D	300 2.4	mW mW/ $^\circ\text{C}$
Thermal Resistance, Junction-to-Ambient (Note 2)	$R_{\theta JA}$	417	$^\circ\text{C}/\text{W}$
Junction and Storage Temperature Range	T_J, T_{stg}	-55 to +150	$^\circ\text{C}$

1. FR-5 = 1.0 × 0.75 × 0.062 in.
2. Alumina = 0.4 × 0.3 × 0.024 in 99.5% alumina.

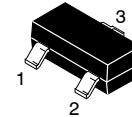
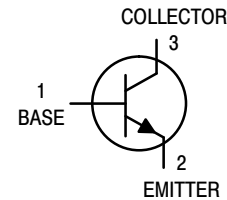

SOT-23
CASE 318
STYLE 6

MARKING DIAGRAM

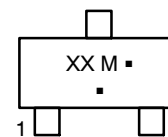

- XX = Device Code
- M = Date Code*
- = Pb-Free Package

(Note: Microdot may be in either location)

*Date Code orientation and/or overbar may vary depending upon manufacturing location.

ORDERING INFORMATION

See detailed ordering and shipping information in the package dimensions section on page 12 of this data sheet.

BC846ALT1G Series, SBC846ALT1G Series

ELECTRICAL CHARACTERISTICS ($T_A = 25^\circ\text{C}$ unless otherwise noted)

Characteristic	Symbol	Min	Typ	Max	Unit	
OFF CHARACTERISTICS						
Collector – Emitter Breakdown Voltage ($I_C = 10\text{ mA}$)	BC846A, B, SBC846A, B BC847A, B, C, BC850B, C, SBC847C BC848A, B, C, BC849B, C, SBC848B	$V_{(BR)CEO}$	65 45 30	– – –	– – –	V
Collector – Emitter Breakdown Voltage ($I_C = 10\ \mu\text{A}$, $V_{EB} = 0$)	BC846A, B BC847A, B, C, BC850B, C, SBC847C BC848A, B, C, BC849B, C, SBC848B	$V_{(BR)CES}$	80 50 30	– – –	– – –	V
Collector – Base Breakdown Voltage ($I_C = 10\ \mu\text{A}$)	BC846A, B, SBC846A, B BC847A, B, C, BC850B, C, SBC847C BC848A, B, C, BC849B, C, SBC848B	$V_{(BR)CBO}$	80 50 30	– – –	– – –	V
Emitter – Base Breakdown Voltage ($I_E = 1.0\ \mu\text{A}$)	BC846A, B, SBC846A, B BC847A, B, C, BC850B, C, SBC847C BC848A, B, C, BC849B, C, SBC848B	$V_{(BR)EBO}$	6.0 6.0 5.0	– – –	– – –	V
Collector Cutoff Current ($V_{CB} = 30\text{ V}$) ($V_{CB} = 30\text{ V}$, $T_A = 150^\circ\text{C}$)		I_{CBO}	– –	– –	15 5.0	nA μA
ON CHARACTERISTICS						
DC Current Gain ($I_C = 10\ \mu\text{A}$, $V_{CE} = 5.0\text{ V}$)	BC846A, BC847A, BC848A, SBC846A BC846B, BC847B, BC848B, SBC846B, SBC848B BC847C, BC848C, SBC847C	h_{FE}	– – –	90 150 270	– – –	–
($I_C = 2.0\text{ mA}$, $V_{CE} = 5.0\text{ V}$)	BC846A, BC847A, BC848A, SBC846A, SBC846A BC846B, BC847B, BC848B, BC849B, BC850B, SBC846B, SBC848B BC847C, BC848C, BC849C, BC850C, SBC847C		110 200 420	180 290 520	220 450 800	
Collector – Emitter Saturation Voltage ($I_C = 10\text{ mA}$, $I_B = 0.5\text{ mA}$) ($I_C = 100\text{ mA}$, $I_B = 5.0\text{ mA}$)		$V_{CE(sat)}$	– –	– –	0.25 0.6	V
Base – Emitter Saturation Voltage ($I_C = 10\text{ mA}$, $I_B = 0.5\text{ mA}$) ($I_C = 100\text{ mA}$, $I_B = 5.0\text{ mA}$)		$V_{BE(sat)}$	– –	0.7 0.9	– –	V
Base – Emitter Voltage ($I_C = 2.0\text{ mA}$, $V_{CE} = 5.0\text{ V}$) ($I_C = 10\text{ mA}$, $V_{CE} = 5.0\text{ V}$)		$V_{BE(on)}$	580 –	660 –	700 770	mV
SMALL-SIGNAL CHARACTERISTICS						
Current – Gain – Bandwidth Product ($I_C = 10\text{ mA}$, $V_{CE} = 5.0\text{ Vdc}$, $f = 100\text{ MHz}$)		f_T	100	–	–	MHz
Output Capacitance ($V_{CB} = 10\text{ V}$, $f = 1.0\text{ MHz}$)		C_{obo}	–	–	4.5	pF
Noise Figure ($I_C = 0.2\text{ mA}$, $V_{CE} = 5.0\text{ Vdc}$, $R_S = 2.0\text{ k}\Omega$, $f = 1.0\text{ kHz}$, $BW = 200\text{ Hz}$)	BC846A,B, BC847A,B,C, BC848A,B,C, SBC846A, B, SBC847C, SBC848B BC849B,C, BC850B,C	NF	– –	– –	10 4.0	dB

BC846ALT1G Series, SBC846ALT1G Series

BC846A, BC847A, BC848A, SBC846A

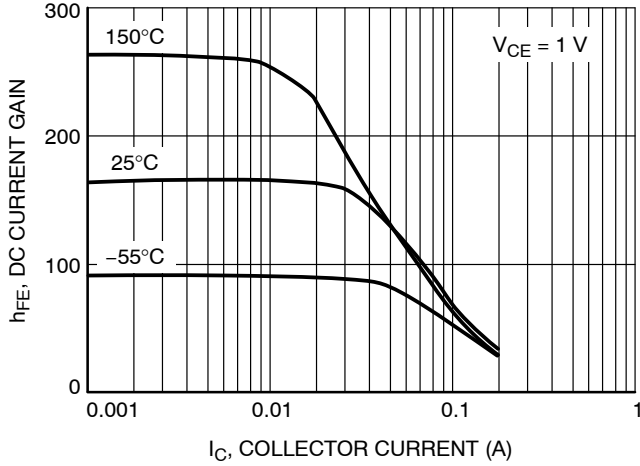

Figure 1. DC Current Gain vs. Collector Current

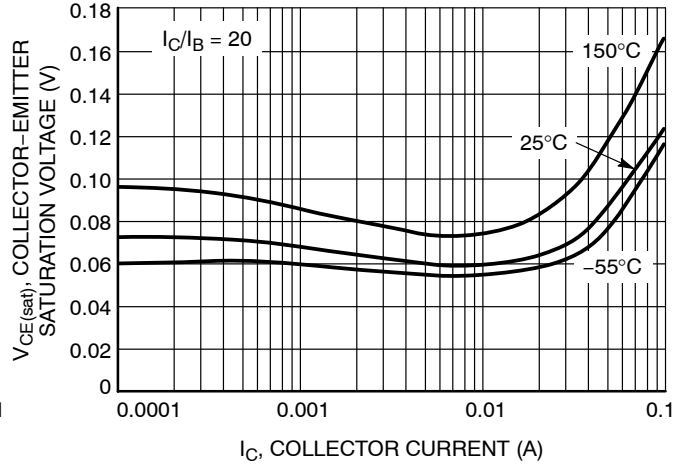

Figure 2. Collector Emitter Saturation Voltage vs. Collector Current

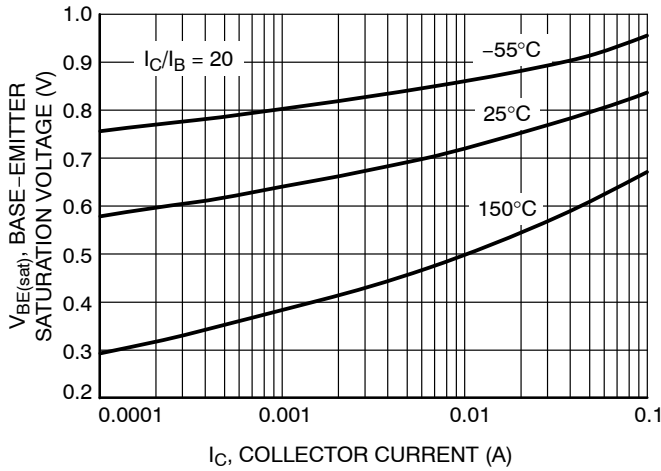

Figure 3. Base Emitter Saturation Voltage vs. Collector Current

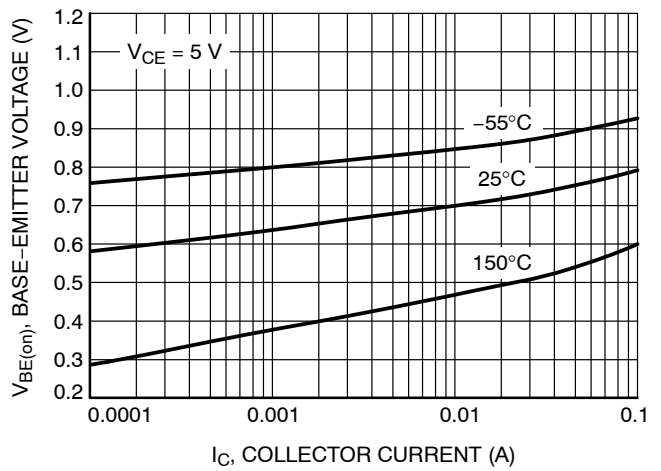

Figure 4. Base Emitter Voltage vs. Collector Current

BC846ALT1G Series, SBC846ALT1G Series

BC846A, BC847A, BC848A, SBC846A

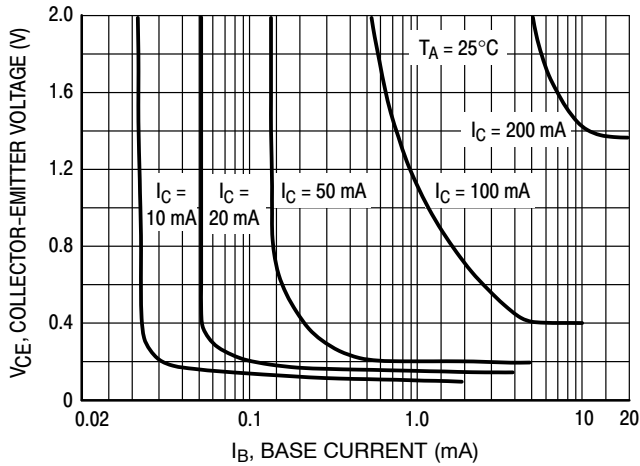

Figure 5. Collector Saturation Region

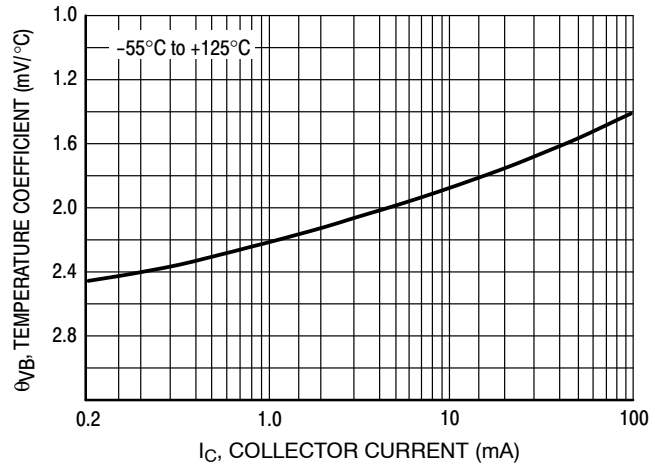

Figure 6. Base-Emitter Temperature Coefficient

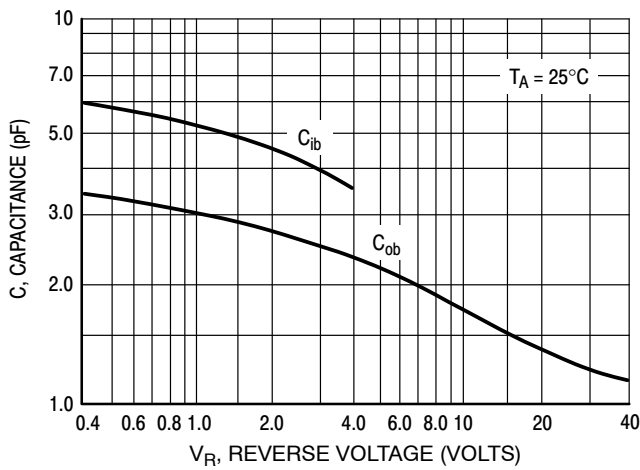

Figure 7. Capacitances

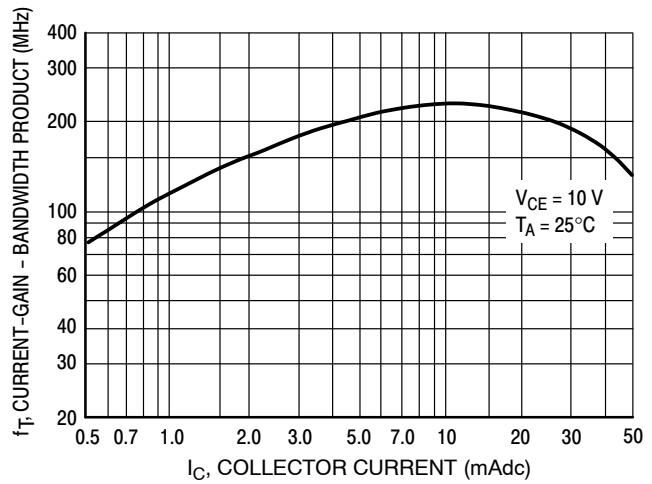

Figure 8. Current-Gain - Bandwidth Product

BC846ALT1G Series, SBC846ALT1G Series

BC846B, SBC846B

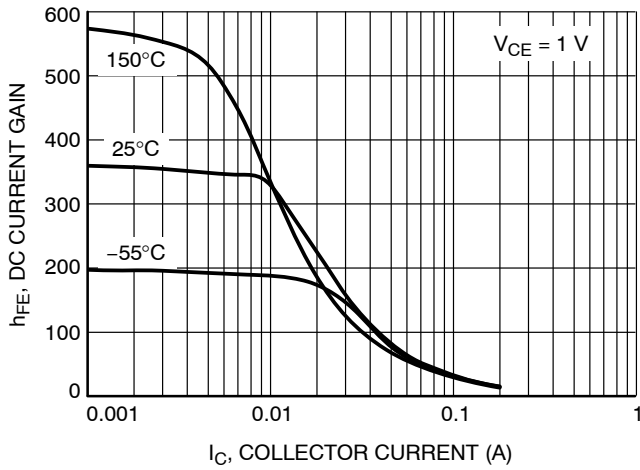

Figure 9. DC Current Gain vs. Collector Current

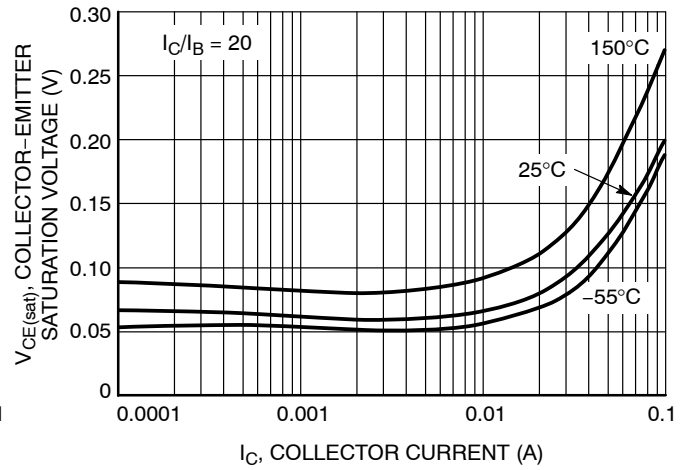

Figure 10. Collector Emitter Saturation Voltage vs. Collector Current

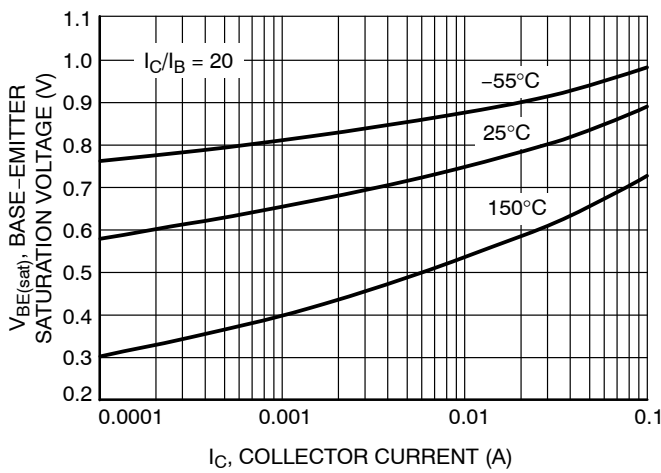

Figure 11. Base Emitter Saturation Voltage vs. Collector Current

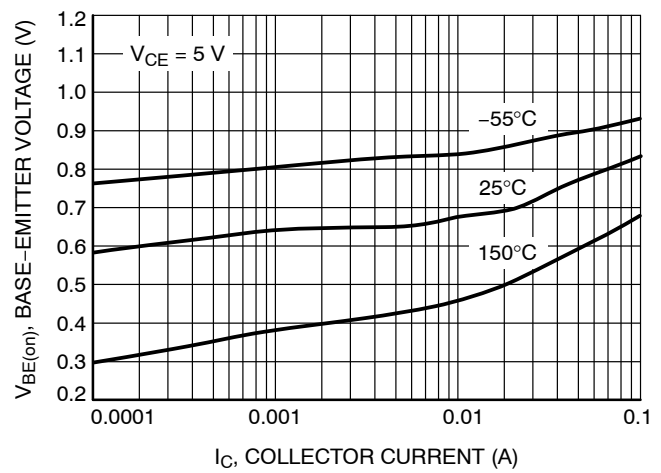

Figure 12. Base Emitter Voltage vs. Collector Current

BC846ALT1G Series, SBC846ALT1G Series

BC846B, SBC846B

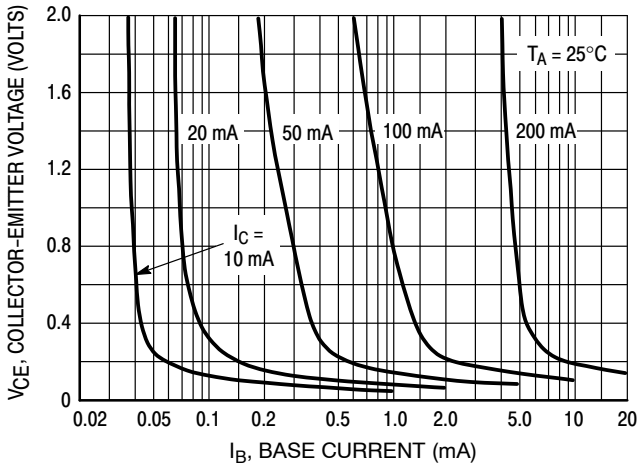

Figure 13. Collector Saturation Region

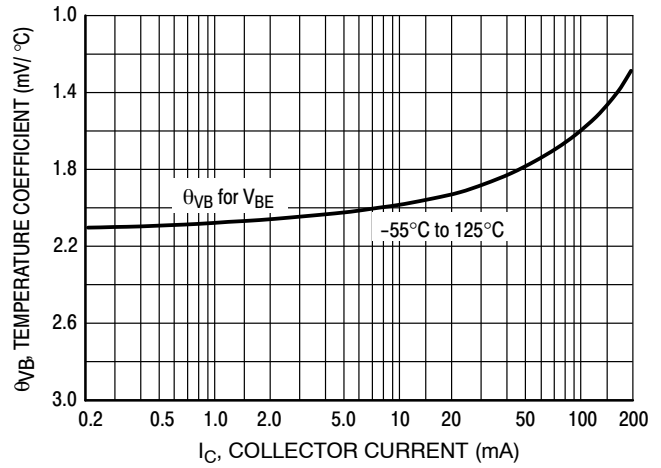

Figure 14. Base-Emitter Temperature Coefficient

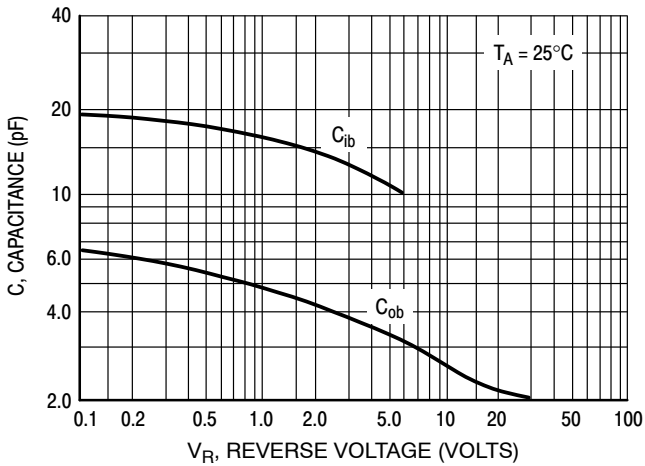

Figure 15. Capacitance

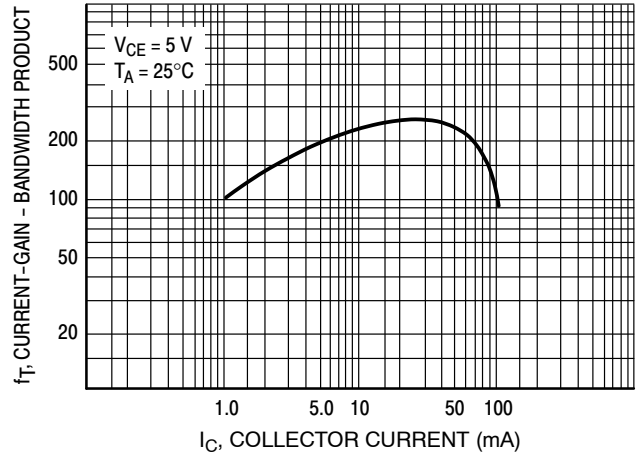

Figure 16. Current-Gain - Bandwidth Product

BC846ALT1G Series, SBC846ALT1G Series

BC847B, BC848B, BC849B, BC850B, SBC846B, SBC847B, SBC848B

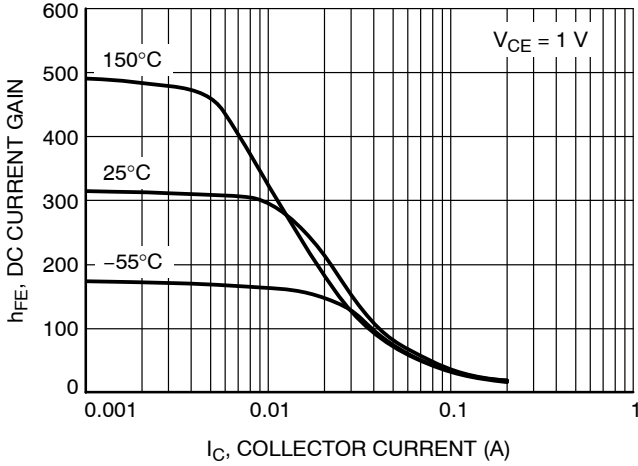

Figure 17. DC Current Gain vs. Collector Current

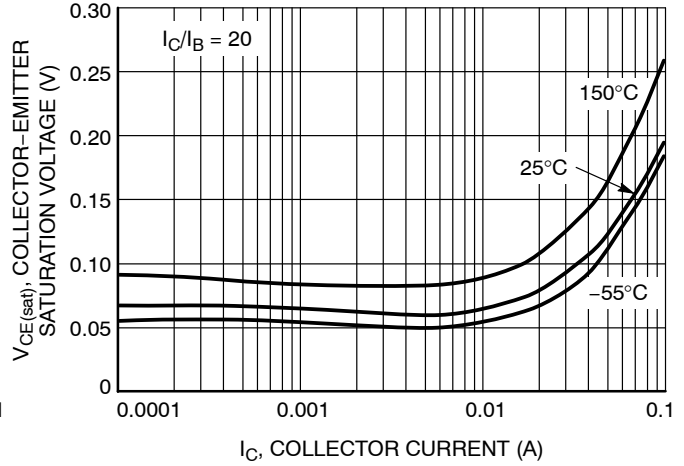

Figure 18. Collector Emitter Saturation Voltage vs. Collector Current

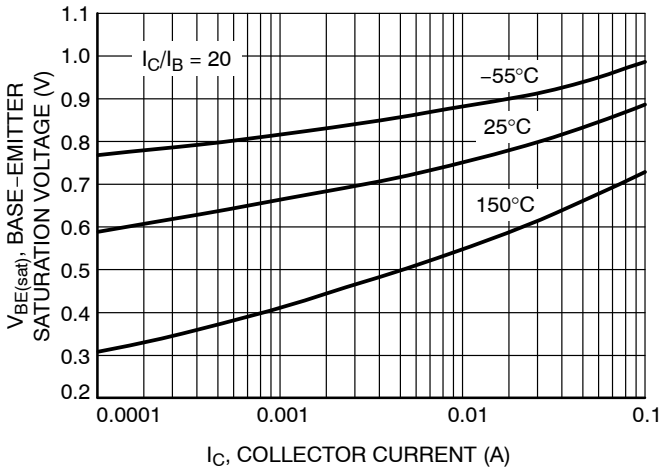

Figure 19. Base Emitter Saturation Voltage vs. Collector Current

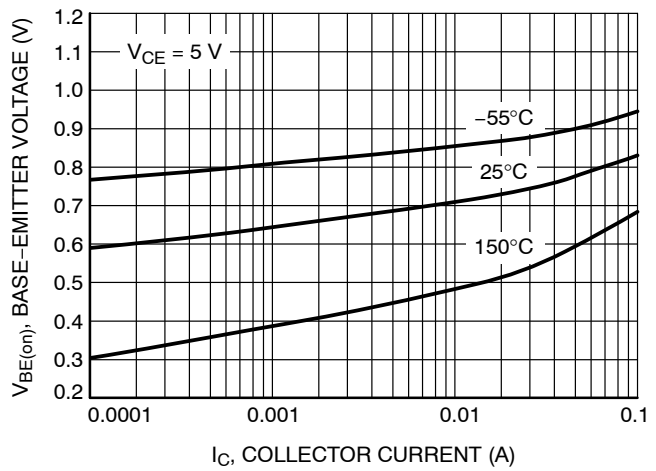

Figure 20. Base Emitter Voltage vs. Collector Current

BC846ALT1G Series, SBC846ALT1G Series

BC847B, BC848B, BC849B, BC850B, SBC846B, SBC847B, SBC848B

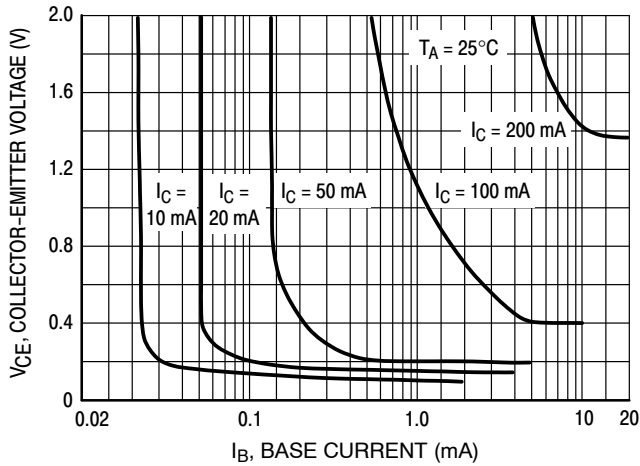

Figure 21. Collector Saturation Region

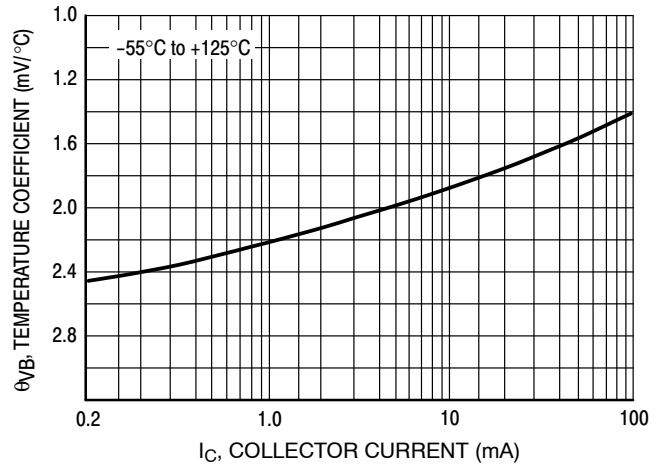

Figure 22. Base-Emitter Temperature Coefficient

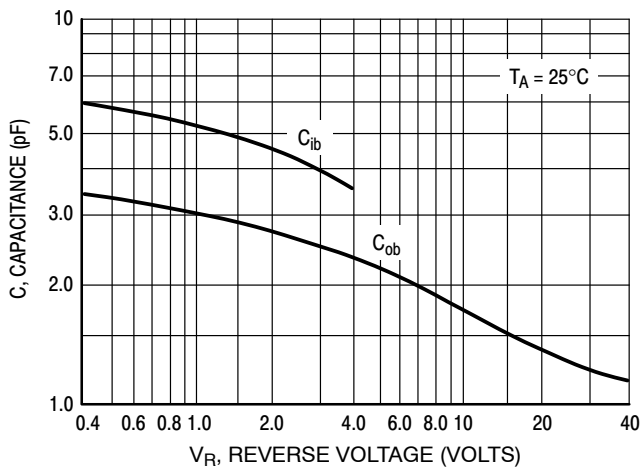

Figure 23. Capacitances

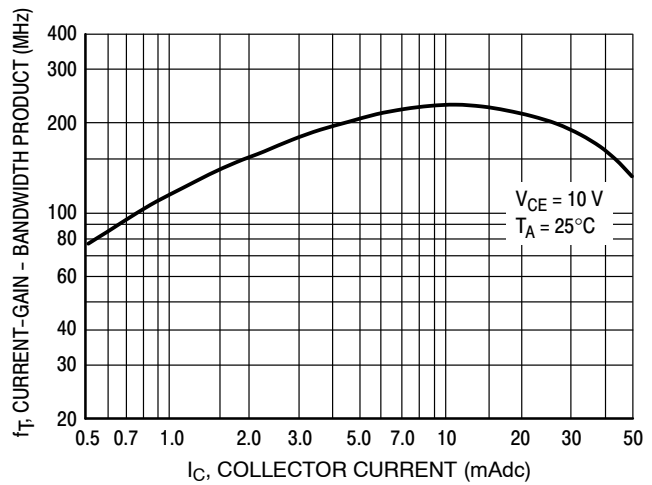

Figure 24. Current-Gain - Bandwidth Product

BC846ALT1G Series, SBC846ALT1G Series

BC847C, BC848C, BC849C, BC850C, SBC847C

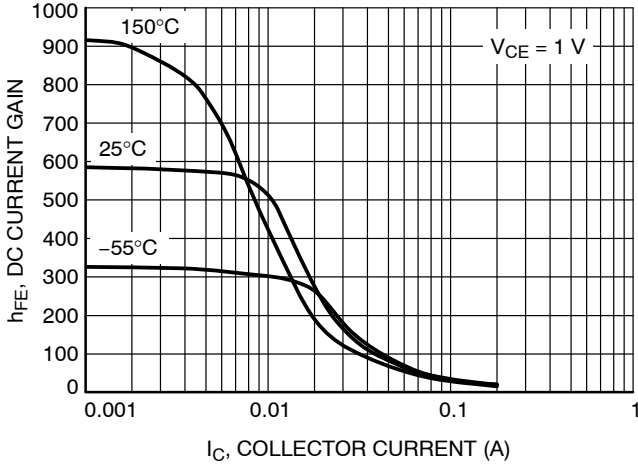

Figure 25. DC Current Gain vs. Collector Current

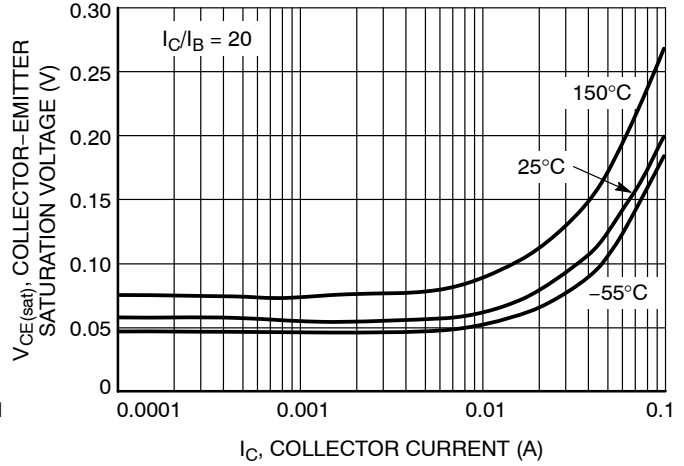

Figure 26. Collector Emitter Saturation Voltage vs. Collector Current

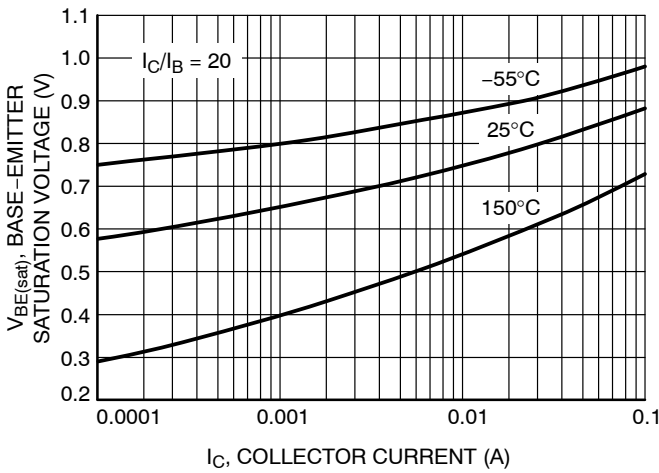

Figure 27. Base Emitter Saturation Voltage vs. Collector Current

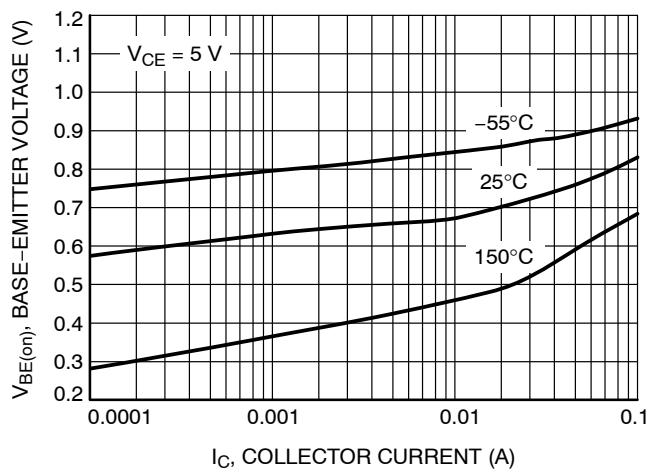

Figure 28. Base Emitter Voltage vs. Collector Current

BC846ALT1G Series, SBC846ALT1G Series

BC847C, BC848C, BC849C, BC850C, SBC847C

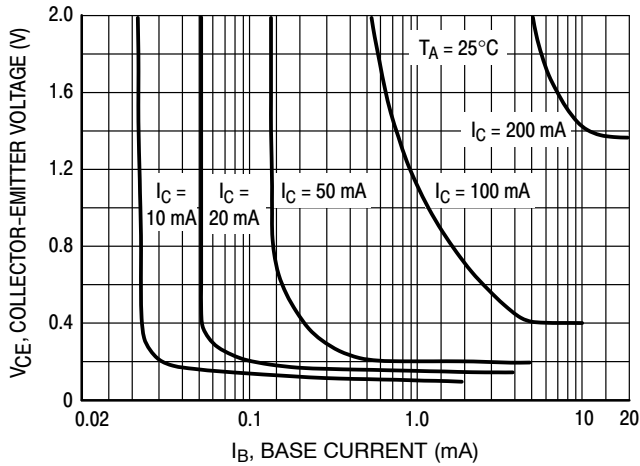

Figure 29. Collector Saturation Region

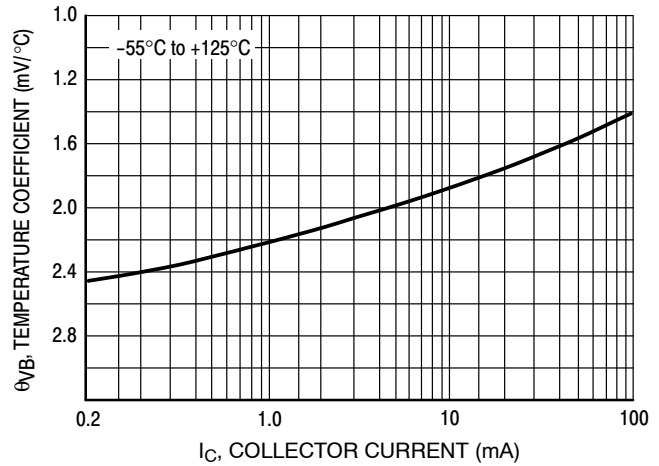

Figure 30. Base-Emitter Temperature Coefficient

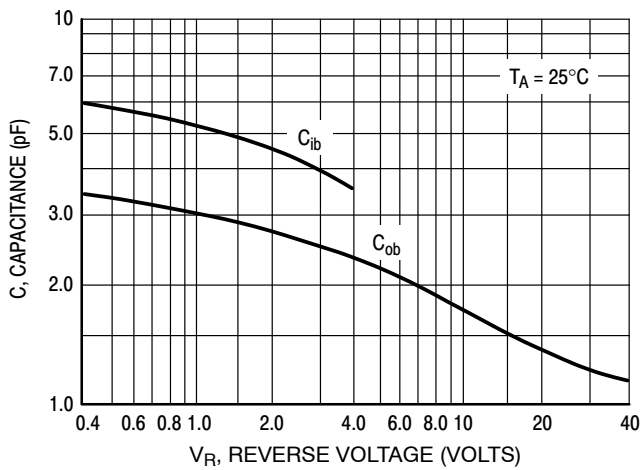

Figure 31. Capacitances

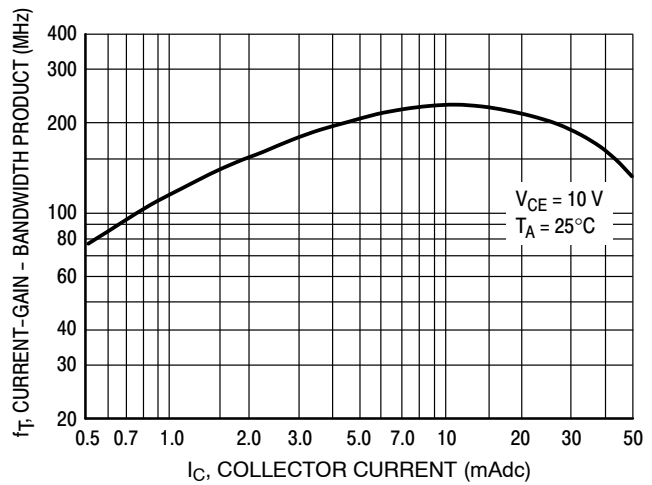

Figure 32. Current-Gain - Bandwidth Product

BC846ALT1G Series, SBC846ALT1G Series

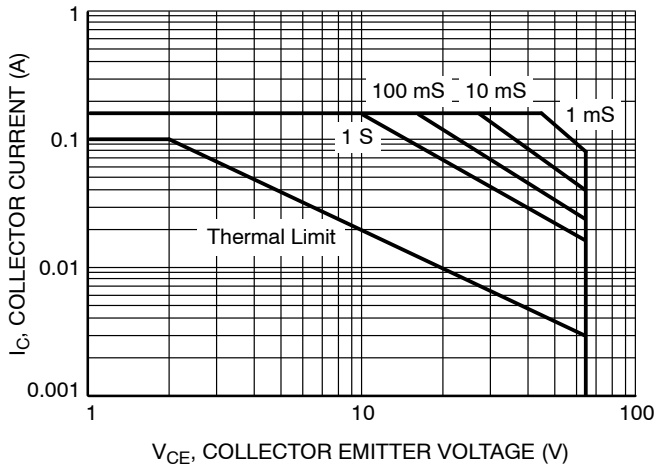

Figure 33. Safe Operating Area for BC846A, BC846B

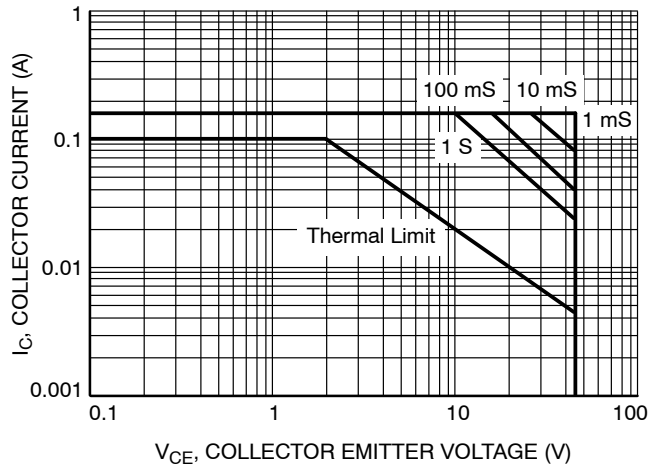

Figure 34. Safe Operating Area for BC847A, BC847B, BC847C, BC850B, BC850C

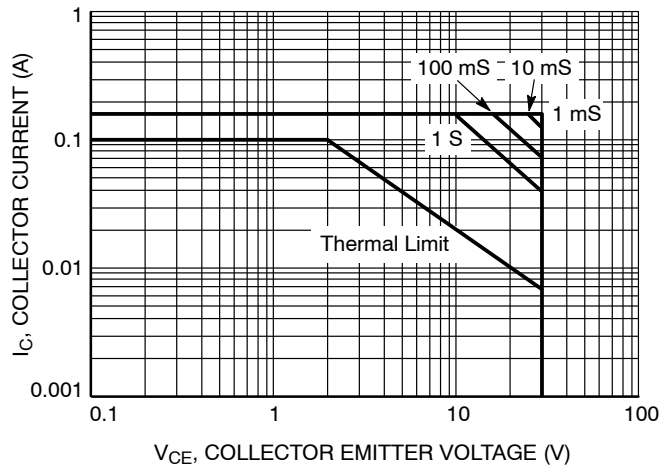

Figure 35. Safe Operating Area for BC848A, BC848B, BC848C, BC849B, BC849C

BC846ALT1G Series, SBC846ALT1G Series

ORDERING INFORMATION

Device	Marking	Package	Shipping†
BC846ALT1G	1A	SOT-23 (Pb-Free)	3,000 / Tape & Reel
SBC846ALT1G			
BC846ALT3G	1A	SOT-23 (Pb-Free)	10,000 / Tape & Reel
BC846BLT1G	1B	SOT-23 (Pb-Free)	3,000 / Tape & Reel
SBC846BLT1G			
BC846BLT3G	1B	SOT-23 (Pb-Free)	10,000 / Tape & Reel
SBC846BLT3G			
BC847ALT1G	1E	SOT-23 (Pb-Free)	3,000 / Tape & Reel
BC847ALT3G		SOT-23 (Pb-Free)	10,000 / Tape & Reel
BC847BLT1G	1F	SOT-23 (Pb-Free)	3,000 / Tape & Reel
SBC847BLT1G			
BC847BLT3G	1F	SOT-23 (Pb-Free)	10,000 / Tape & Reel
BC847CLT1G	1G	SOT-23 (Pb-Free)	3,000 / Tape & Reel
SBC847CLT1G			
BC847CLT3G	1G	SOT-23 (Pb-Free)	10,000 / Tape & Reel
BC848ALT1G	1J	SOT-23 (Pb-Free)	3,000 / Tape & Reel
BC848BLT1G	1K	SOT-23 (Pb-Free)	3,000 / Tape & Reel
SBC848BLT1G			
BC848BLT3G	1K	SOT-23 (Pb-Free)	10,000 / Tape & Reel
BC848CLT1G	1L	SOT-23 (Pb-Free)	3,000 / Tape & Reel
BC848CLT3G		SOT-23 (Pb-Free)	10,000 / Tape & Reel
BC849BLT1G	2B	SOT-23 (Pb-Free)	3,000 / Tape & Reel
BC849BLT3G		SOT-23 (Pb-Free)	10,000 / Tape & Reel
BC849CLT1G	2C	SOT-23 (Pb-Free)	3,000 / Tape & Reel
BC849CLT3G		SOT-23 (Pb-Free)	10,000 / Tape & Reel
BC850BLT1G	2F	SOT-23 (Pb-Free)	3,000 / Tape & Reel
BC850CLT1G	2G	SOT-23 (Pb-Free)	

†For information on tape and reel specifications, including part orientation and tape sizes, please refer to our Tape and Reel Packaging Specifications Brochure, BRD8011/D.

BC846ALT1G Series, SBC846ALT1G Series

PACKAGE DIMENSIONS

SOT-23 (TO-236)
CASE 318-08
ISSUE AP

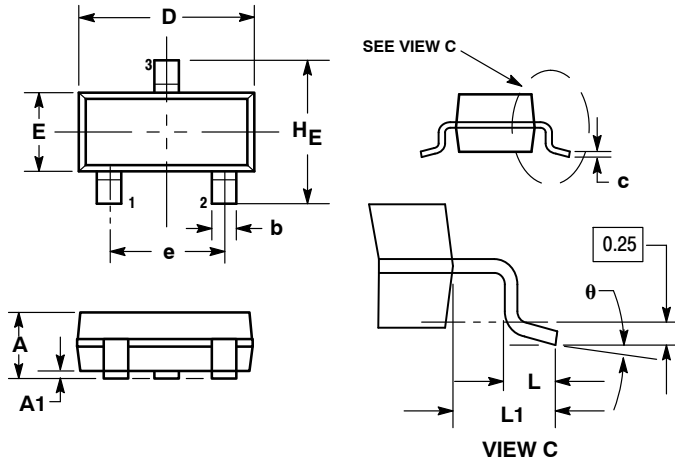

- NOTES:
1. DIMENSIONING AND TOLERANCING PER ANSI Y14.5M, 1982.
 2. CONTROLLING DIMENSION: INCH.
 3. MAXIMUM LEAD THICKNESS INCLUDES LEAD FINISH THICKNESS. MINIMUM LEAD THICKNESS IS THE MINIMUM THICKNESS OF BASE MATERIAL.
 4. DIMENSIONS D AND E DO NOT INCLUDE MOLD FLASH, PROTRUSIONS, OR GATE BURRS.

DIM	MILLIMETERS			INCHES		
	MIN	NOM	MAX	MIN	NOM	MAX
A	0.89	1.00	1.11	0.035	0.040	0.044
A1	0.01	0.06	0.10	0.001	0.002	0.004
b	0.37	0.44	0.50	0.015	0.018	0.020
c	0.09	0.13	0.18	0.003	0.005	0.007
D	2.80	2.90	3.04	0.110	0.114	0.120
E	1.20	1.30	1.40	0.047	0.051	0.055
e	1.78	1.90	2.04	0.070	0.075	0.081
L	0.10	0.20	0.30	0.004	0.008	0.012
L1	0.35	0.54	0.69	0.014	0.021	0.029
HE	2.10	2.40	2.64	0.083	0.094	0.104
θ	0°	---	10°	0°	---	10°

STYLE 6:
PIN 1. BASE
2. EMITTER
3. COLLECTOR

SOLDERING FOOTPRINT*

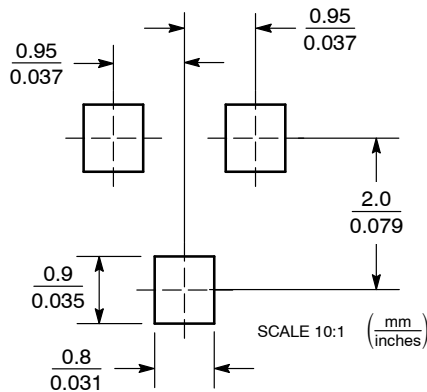

*For additional information on our Pb-Free strategy and soldering details, please download the ON Semiconductor Soldering and Mounting Techniques Reference Manual, SOLDERRM/D.

ON Semiconductor and are registered trademarks of Semiconductor Components Industries, LLC (SCILLC). SCILLC reserves the right to make changes without further notice to any products herein. SCILLC makes no warranty, representation or guarantee regarding the suitability of its products for any particular purpose, nor does SCILLC assume any liability arising out of the application or use of any product or circuit, and specifically disclaims any and all liability, including without limitation special, consequential or incidental damages. "Typical" parameters which may be provided in SCILLC data sheets and/or specifications can and do vary in different applications and actual performance may vary over time. All operating parameters, including "Typicals" must be validated for each customer application by customer's technical experts. SCILLC does not convey any license under its patent rights nor the rights of others. SCILLC products are not designed, intended, or authorized for use as components in systems intended for surgical implant into the body, or other applications intended to support or sustain life, or for any other application in which the failure of the SCILLC product could create a situation where personal injury or death may occur. Should Buyer purchase or use SCILLC products for any such unintended or unauthorized application, Buyer shall indemnify and hold SCILLC and its officers, employees, subsidiaries, affiliates, and distributors harmless against all claims, costs, damages, and expenses, and reasonable attorney fees arising out of, directly or indirectly, any claim of personal injury or death associated with such unintended or unauthorized use, even if such claim alleges that SCILLC was negligent regarding the design or manufacture of the part. SCILLC is an Equal Opportunity/Affirmative Action Employer. This literature is subject to all applicable copyright laws and is not for resale in any manner.

PUBLICATION ORDERING INFORMATION

LITERATURE FULFILLMENT:
Literature Distribution Center for ON Semiconductor
P.O. Box 5163, Denver, Colorado 80217 USA
Phone: 303-675-2175 or 800-344-3860 Toll Free USA/Canada
Fax: 303-675-2176 or 800-344-3867 Toll Free USA/Canada
Email: orderlit@onsemi.com

N. American Technical Support: 800-282-9855 Toll Free
USA/Canada
Europe, Middle East and Africa Technical Support:
Phone: 421 33 790 2910
Japan Customer Focus Center
Phone: 81-3-5817-1050

ON Semiconductor Website: www.onsemi.com
Order Literature: <http://www.onsemi.com/orderlit>
For additional information, please contact your local
Sales Representative