

New

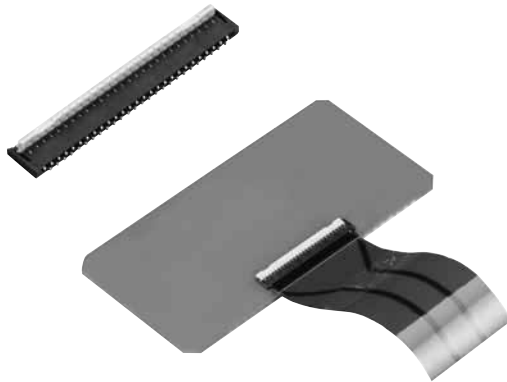

Compliance with RoHS Directive

FEATURES

1. Ultra slim and low profile design (Pitch: 0.3 mm)
The adoption of the back lock has achieved the ultra-slim body with a 3.15 mm depth (including the lever).
The 0.9 mm low-profile facilitates the thickness and size reduction of target equipment.

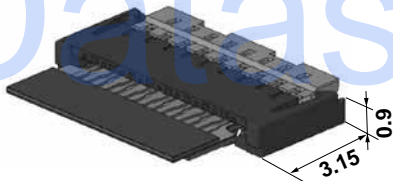

Unit: mm

- 2. High holding force has been achieved in addition to a structure able to temporarily hold the FPC.
- 3. Excellent workability

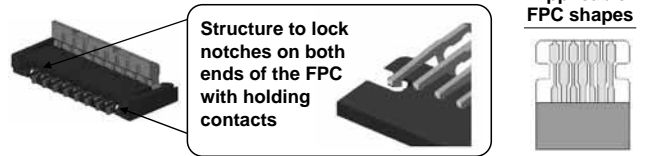

- (1) The inserted FPC can be temporarily held until the lever is closed.
- (2) When the lever is closed, the holding contacts lock the FPC by its notches, enhancing the FPC holding force.
- 4. Mechanical design freedom achieved by top and bottom double contacts**
- 5. Easy-to-handle back lock structure**
- 6. Wiring patterns can be located underneath the connector.**
- 7. Man-hours for assembly can be reduced by delivering the connectors with their levers opened.**

APPLICATIONS

Compact mobile devices “Cellular phones, Smartphones, Tablet PC, Digital cameras and DVC, etc”

ORDERING INFORMATION

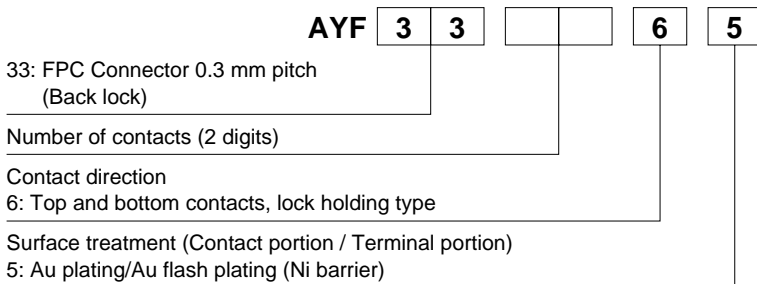

PRODUCT TYPES

Height	Number of contacts	Part number	Packing	
			Inner carton (1-reel)	Outer carton
0.9 mm	11	AYF331165	5,000 pieces	10,000 pieces
	25	AYF332565		
	51	AYF335165		

Notes: 1. Order unit;

For mass production: in 1-inner carton (1-reel) units

Samples for mounting check: in 50-connector units. Please contact our sales office.

2. Please contact our sales office for connectors having a number of contacts other than those listed above.

SPECIFICATIONS

1. Characteristics

	Item	Specifications	Conditions
Electrical characteristics	Rated current	0.2A/contact	
	Rated voltage	50V AC/DC	
	Insulation resistance	Min. 1,000M Ω (initial)	Using 250V DC megger (applied for 1 min.)
	Breakdown voltage	150V AC for 1 min.	No short-circuiting or damage at a detection current of 1 mA when the specified voltage is applied for one minute.
	Contact resistance	Max. 100m Ω	Based on the contact resistance measurement method specified by JIS C 5402.
Mechanical characteristics	FPC holding force	Min. 0.13N/contacts \times contacts + 1.00N (initial)	Measurement of the maximum force applied until the inserted compatible FPC is pulled out in the insertion axis direction while the connector lever is closed
	Contact holding force	Min. 0.20N/contacts	Measuring the maximum force. As the contact and holding contact are axially pull out.
Environmental characteristics	Ambient temperature	-55°C to +85°C	No freezing at low temperatures. No dew condensation.
	Storage temperature	-55°C to +85°C (product only) -40°C to +50°C (emboss packing)	
	Thermal shock resistance (with FPC inserted)	5 cycles, insulation resistance min. 100M Ω , contact resistance max. 100m Ω	Sequence 1. -55 $\frac{3}{5}$ °C, 30 minutes 2. ~, Max. 5 minutes 3. 85 $\frac{3}{5}$ °C, 30 minutes 4. ~, Max. 5 minutes
	Humidity resistance (with FPC inserted)	120 hours, insulation resistance min. 100M Ω , contact resistance max. 100m Ω	Bath temperature 40 \pm 2°C, humidity 90 to 95% R.H.
	Saltwater spray resistance (with FPC inserted)	24 hours, insulation resistance min. 100M Ω , contact resistance max. 100m Ω	Bath temperature 35 \pm 2°C, saltwater concentration 5 \pm 1%
	H ₂ S resistance (with FPC inserted)	48 hours, contact resistance max. 100m Ω	Bath temperature 40 \pm 2°C, gas concentration 3 \pm 1 ppm, humidity 75 to 80% R.H.
	Soldering heat resistance	Peak temperature: 260°C or less 300°C within 5 sec. 350°C within 3 sec.	Reflow soldering Soldering iron
Lifetime characteristics	Insertion and removal life	20 times	Repeated insertion and removal: min. 10 sec./time
Unit weight		51-contact type: 0.09 g	

2. Material and surface treatment

Part name	Material	Surface treatment
Molded portion	Housing: LCP resin (UL94V-0) Lever: LCP resin (UL94V-0)	—
Contact	Copper alloy	Contact portion; Base: Ni plating, Surface: Au plating Terminal portion; Base: Ni plating, Surface: Au plating
Holding contact	Copper alloy	Base: Ni plating, Surface: Au plating

DIMENSIONS (Unit: mm)

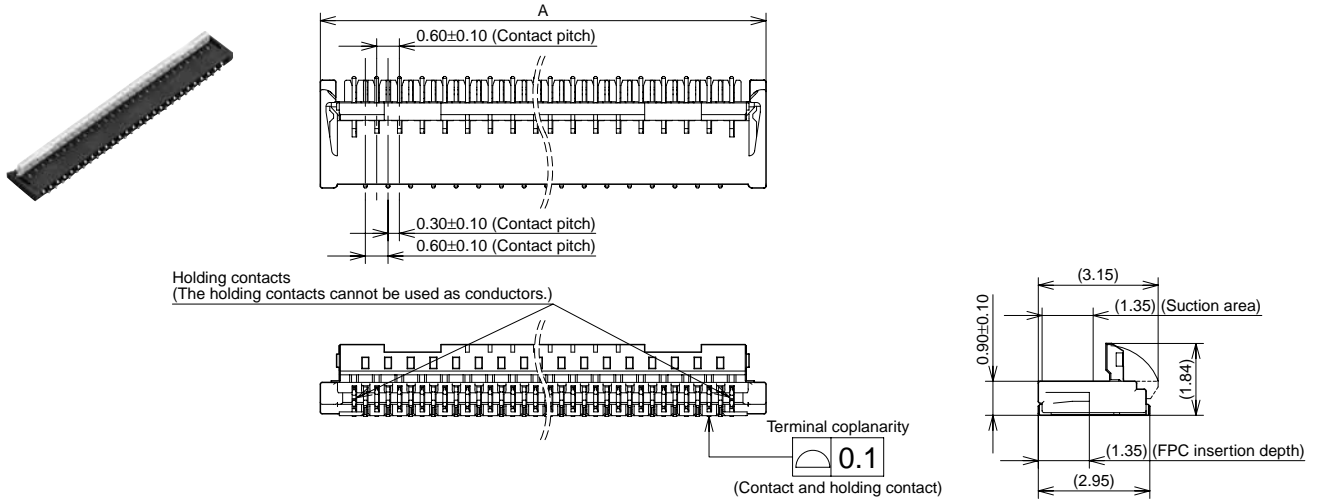

General tolerance: ±0.3

Number of contacts/ dimension	A	B	C	D
11	5.40	3.00	2.40	3.60
25	9.60	7.20	6.60	7.80
51	17.40	15.00	14.40	15.60

Recommended FPC dimensions

(Finished thickness: t = 0.2±0.03)

The conductive parts should be based by Ni plating and then Au plating.

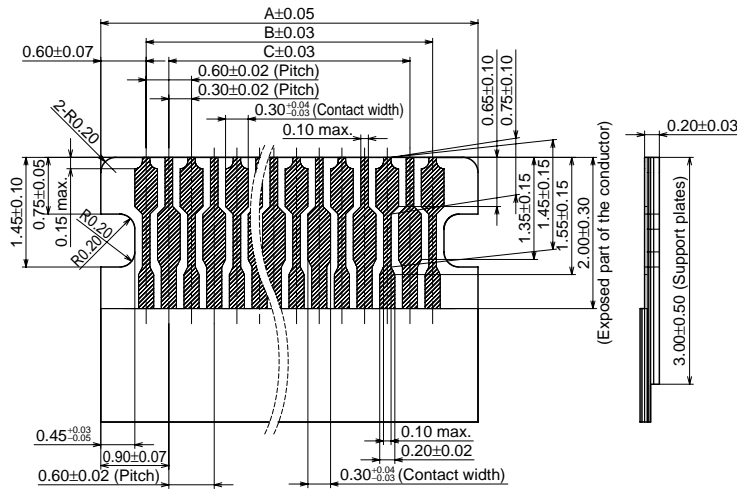

Number of contacts/ dimension	A	B	C
11	4.20	3.00	2.40
25	8.40	7.20	6.60
51	16.20	15.00	14.40

EMBOSSED TAPE DIMENSIONS (Unit: mm) (Common for respective contact type)

• Specifications for taping

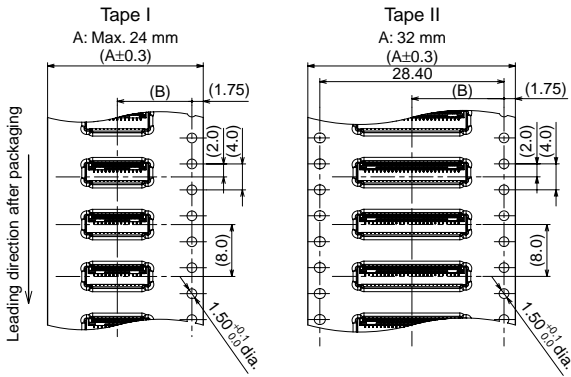

• Specifications for the plastic reel
(In accordance with EIAJ ET-7200B)

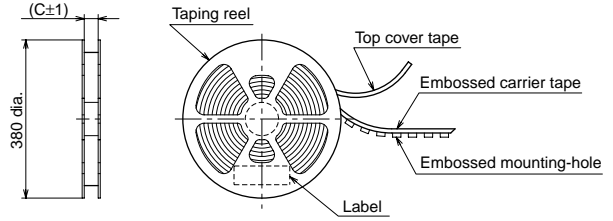

• Dimension table (Unit: mm)

Number of contacts	Type of taping	A	B	C	Quantity per reel
11 contacts	Tape I	16.0	7.5	17.4	5,000
25 contacts	Tape I	24.0	11.5	25.4	5,000
51 contacts	Tape II	32.0	14.2	33.4	5,000

• Connector orientation with respect to embossed tape feeding direction

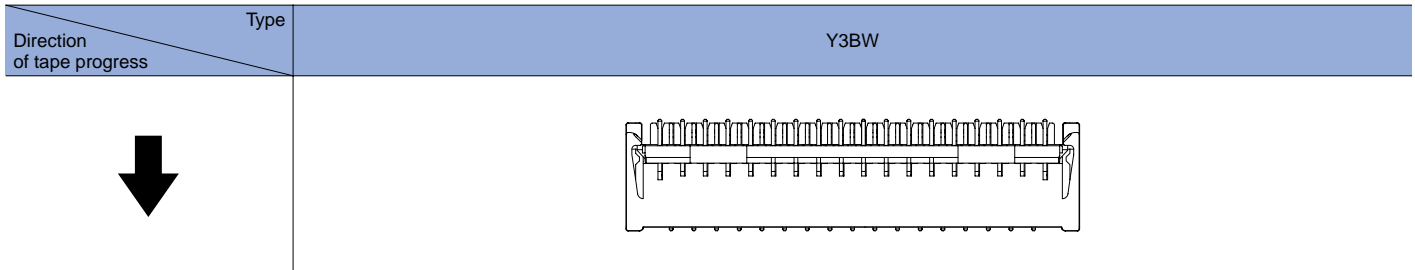

NOTES

1. Recommended PC board and metal mask patterns

Appropriate control of solder amount is required to minimize solder bridges and other defects for connectors with 0.2 mm or 0.3 mm pitch terminals, which require high-density mounting. Refer to the recommended pattern.

Recommended PC board pattern
(Mount pad arrangement pattern) (TOP VIEW)

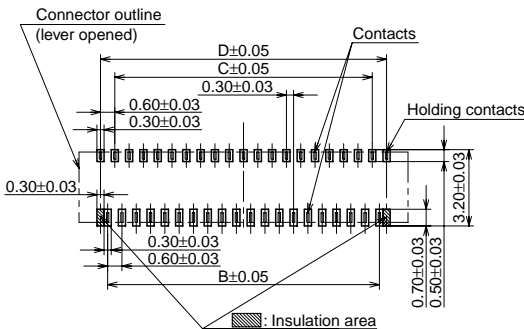

Number of contacts/ dimension	B	C	D
11	3.00	2.40	3.60
25	7.20	6.60	7.80
51	15.00	14.40	15.60

Recommended PC board pattern (TOP VIEW)

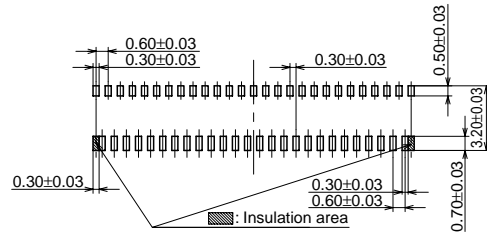

Recommended metal mask pattern
Metal mask thickness: When 120 μm
(Terminal opening ratio: 50%)
(Metal-part opening ratio: 51%)

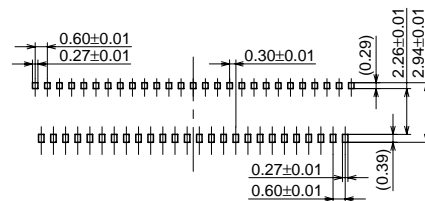

2. Holding contacts

The holding contacts cannot be used as conductors. The holding contacts are located on both ends of the contacts, and the shape of the soldered portions is the same as that of the other contacts. Therefore, be careful to avoid any confusion.

3. Precautions for insertion/removal of FPC

Avoid touching the lever (applying any external force) until an FPC is inserted. Do not open/close the lever without an FPC inserted. Failure to follow this instruction will cause the contacts to warp, leading to the contact tips interfering with the insertion of an FPC, deforming the terminals. Failure to follow this instruction may cause the lever to be removed, terminals to be deformed, and/or the FPC insertion force to increase.

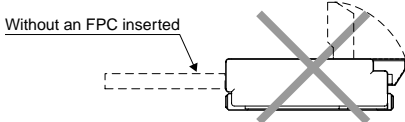

These connectors are of the back lock type, which has the FPC insertion section on the opposite side of the lever. Be careful not to make a mistake in the FPC insertion position or the lever opening/closing position. Otherwise, a contact failure or connector breakage may occur.

These connectors have top and bottom double contacts. Do not insert an FPC upside down. Inserting an FPC in a direction opposite to that you intended may cause an operation failure or malfunction.

Insert an FPC with the lever opened at right angle, that is, in the factory default position.

Completely insert the FPC horizontally. An FPC inserted at an excessive angle to the board may cause the deformation of metal parts, FPC insertion failures, and FPC circuit breakages. Insert the FPC to the full depth of the connector without altering the angle.

Do not apply an excessive load to the lever in the opening direction beyond its open position; otherwise, the lever may be deformed or removed.

Do not apply an excessive load to the lever in a direction perpendicular to the lever rotation axis or in the lever opening direction; otherwise, the terminals may be deformed, and the lever may be removed.

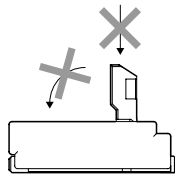

To close the lever, turn down the lever by pressing the entire lever or both sides of the lever with the balls of fingers. Be careful. If pressure to the lever is applied unevenly, such as to an edge only, it may deform or break. Also, make sure that the lever is closed completely. Not doing so will cause a faulty connection. Avoid applying an excessive load to the top of the lever during or after closing the lever. Otherwise, the terminals may be deformed.

When opening the lever to remove the FPC, ensure that the lever will not go over the initial position; otherwise, the lever may be removed.

To open the lever, a load applied to the lever unevenly or on only one side may deform and break the lever.

Remove the FPC at parallel with the lever fully opened. If the lever is closed, or if the FPC is forcedly pulled, the product or FPC may break.

If a lever is accidentally detached during the handling of a connector, do not use the connector any longer.

After an FPC is inserted, carefully handle it so as not to apply excessive stress to the base of the FPC.

Please follow the precautions below when wiring the connected FPC.

Depending on the conditions of use, conduction failures, connector breakage, removal of the lever lock, FPC breaks/damage, or other problems may be caused.

- Carefully wiring the FPC so as not to apply a load directly to the connector.
- Avoid sharply bending the FPC by the base at the FPC insertion point of the connector.
- Keep the wired points of the FPC free from a load.
- Fix the FPC if it is possible that a load may be applied to the FPC.
- Keep the FPC notches free from a bending load.

Bending stress tends to concentrate on notches and may cause the FPC to be broken or damaged.

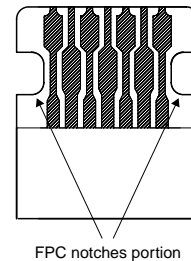

For other details, please verify with the product specification sheets.

NOTES FOR USE (COMMON)

1. PC board design

Design the recommended foot pattern in order to secure the mechanical strength in the soldered areas of the terminal.

2. FPC and equipment design

Design the FPC based on the recommended dimensions to ensure the required connector performance. In addition, carefully check the equipment design and take required measures for the equipment to prevent the FPC from being removed subsequent to a fall, vibration, or other impact due to the FPC size, weight, or the reaction force of the routed FPC.

3. Connector mounting

In case the connector is picked up by chucking during mounting, an excessive moulder chucking force may deform the molded or metal part of the connector. Consult us in advance if chucking is to be applied.

4. Soldering

1) Manual soldering

- Due to the low profile, if an excessive amount of solder is applied to this product during manual soldering, the solder may creep up to near the contact points, or interference by solder may cause imperfect contact.
- Make sure that the soldering iron tip is heated within the temperature and time limits indicated in the specifications.
- Flux from the solder wire may adhere to the contact surfaces during soldering operations. After soldering, carefully check the contact surfaces and clean off any flux before use.
- Be aware that a load applied to the connector terminals while soldering may displace the contact.
- Thoroughly clean the iron tip.

2) Reflow soldering

- Screen-printing is recommended for printing paste solder
- To determine the relationship between the screen opening area and the PC board foot pattern area, refer to the diagrams in the recommended patterns for PC boards and metal masks when setting.
- Note that excess solder on the terminals prevents complete insertion of the FPC, and that excess solder on the metal clips prevents the lever from rotating.
- Note that excess solder inhibits the slider lock operation.

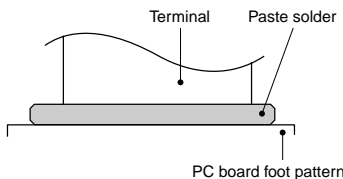

- Screen thickness of 120µm is recommended for paste solder printing.
- Consult us when using a screen-printing thickness other than that recommended.
- Depending on the size of the connector being used, self alignment may not be possible. Accordingly, carefully position the terminal with the PC board pattern.

- The recommended reflow temperature profile is given in the figure below.

Recommended reflow temperature profile

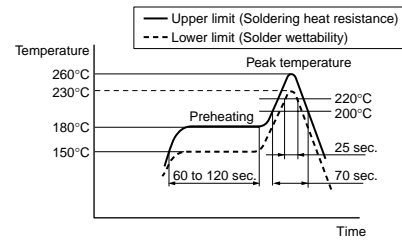

- The temperature is measured on the surface of the PC board near the connector terminal.
- Some solder and flux types may cause serious solder creeping. Take the solder and flux characteristics into consideration when setting the reflow soldering conditions.
- When performing reflow soldering on the back of the PC board after reflow soldering the connector, secure the connector using, for example, an adhesive. (Double reflow soldering on the same side is possible)
- 3) Reworking on a soldered portion
 - Finish reworking in one operation.
 - For reworking of the solder bridge, use a soldering iron with a flat tip. Do not add flux, otherwise, the flux may creep to the contact parts.
 - Use a soldering iron whose tip temperature is within the temperature range specified in the specifications.

5. Do not drop the product or handle carelessly. Otherwise, the terminals may become deformed due to excessive force or the solderability during reflow soldering may degrade.

6. Don't open/close the lever or insert/remove an FPC until the connector is soldered. Forcibly applied external pressure on the terminals can weaken the adherence of the terminals to the molded part or cause the terminals to lose their evenness. In addition, do not insert an FPC into the connector before soldering the connector.

7. When cutting or bending the PC board after mounting the connector, be careful that the soldered sections are subjected to excessive forces.

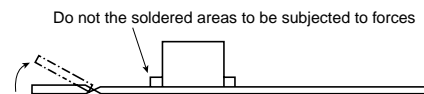

8. Other notes

When coating the PC board after soldering the connector to prevent the deterioration of insulation, perform the coating in such a way so that the coating does not get on the connector. The connectors are not meant to be used for switching.

For other details, please verify with the product specification sheets.