

TCR2BF series TCR2BE series

200 mA CMOS Low Drop-Out Regulator with Auto-discharge

The TCR2BF series and TCR2BE series are CMOS general-purpose single-output voltage regulators with an on/off control input, featuring low dropout voltage and low quiescent bias current. These voltage regulators can be enabled and disabled via the CONTROL pin.

These voltage regulators are available in fixed output voltages between 1.0 V and 5.0 V in SMV package, 1.0 to 3.6V in ESV package, and capable of driving up to 200 mA. They feature overcurrent protection and auto-discharge function.

The TCR2BF series and TCR2BE series are offered in the compact SMV (SOT-25)(SC-74A) and ESV (SOT-553) and allow the use of small ceramic input and output capacitors. Thus, these devices are ideal for portable applications that require high-density board assembly such as cellular phones.

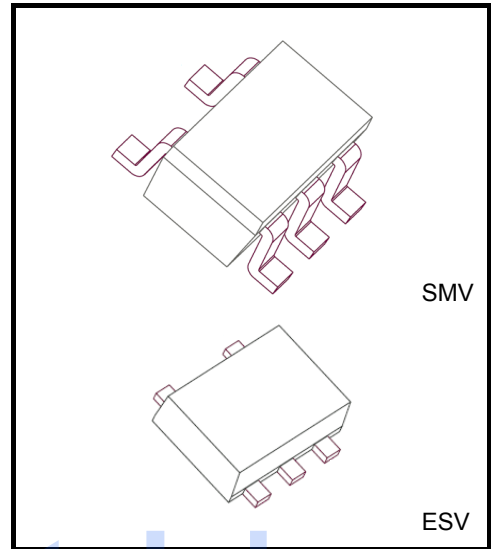

Weight:
SMV (SOT-25)(SC-74A) : 16 mg (typ.)
ESV (SOT-553) : 3.0 mg (typ.)

Features

- Wide fixed output voltage line up
TCR2BF series (SMV package) : $V_{OUT} = 1.0$ to 5.0 V
TCR2BE series (ESV package) : $V_{OUT} = 1.0$ to 3.6 V
- Low output noise voltage ($V_{NO} = 50 \mu V_{RMS}$ (typ.) at 2.8 V-output, $I_{OUT} = 10$ mA, $10 \text{ Hz} \leq f \leq 100 \text{ kHz}$)
- Low quiescent bias current ($I_B = 75 \mu A$ (max) at $I_{OUT} = 0$ mA)
- Low stand-by current ($I_{B(OFF)} = 0.1 \mu A$ (typ.) at Stand-by mode)
- High ripple rejection (R.R. = 70 dB (typ.) at $I_{OUT} = 10$ mA, $f = 1\text{kHz}$)
- Overcurrent protection
- Auto-discharge
- Pull-down connection at CONTROL
- Ceramic capacitors can be used ($C_{IN} = 0.1\mu F$, $C_{OUT} = 1.0 \mu F$)
- Small package, SMV (SOT-25) (SC-74A) and ESV (SOT-553)

Pin Assignment (top view)

SMV (SOT-25)(SC-74A)

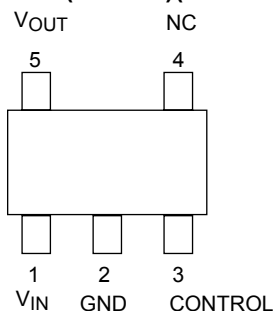

ESV (SOT-553)

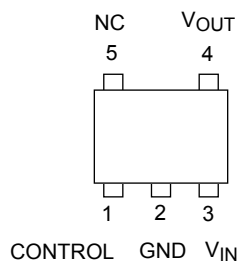

List of Products Number, Output Voltage, and Marking

Product No.		V _{OUT} (V)(typ.)	Marking	Product No.		V _{OUT} (V)(typ.)	Marking
SMV(SOT-25)	ESV(SOT-553)			SMV(SOT-25)	ESV(SOT-553)		
TCR2BF10	TCR2BE10	1.0	1M0	TCR2BF29*	TCR2BE29*	2.9	2M9
TCR2BF105*	TCR2BE105*	1.05	1MA	TCR2BF295*	TCR2BE295*	2.95	2ME
TCR2BF11*	TCR2BE11*	1.1	1M1	TCR2BF30	TCR2BE30	3.0	3M0
TCR2BF115	TCR2BE115	1.15	1MB	TCR2BF31	TCR2BE31	3.1	3M1
TCR2BF12	TCR2BE12	1.2	1M2	TCR2BF32	TCR2BE32	3.2	3M2
TCR2BF125	TCR2BE125	1.25	1MC	TCR2BF33	TCR2BE33	3.3	3M3
TCR2BF13*	TCR2BE13*	1.3	1M3	TCR2BF34*	TCR2BE34*	3.4	3M4
TCR2BF14*	TCR2BE14*	1.4	1M4	TCR2BF35*	TCR2BE35*	3.5	3M5
TCR2BF15	TCR2BE15	1.5	1M5	TCR2BF36	TCR2BE36	3.6	3M6
TCR2BF16*	TCR2BE16*	1.6	1M6	TCR2BF37*	—	3.7	3M7
TCR2BF17*	TCR2BE17*	1.7	1M7	TCR2BF38*	—	3.8	3M8
TCR2BF175*	TCR2BE175*	1.75	1MF	TCR2BF39*	—	3.9	3M9
TCR2BF18	TCR2BE18	1.8	1M8	TCR2BF40	—	4.0	4M0
TCR2BF19*	TCR2BE19*	1.9	1M9	TCR2BF41*	—	4.1	4M1
TCR2BF20*	TCR2BE20*	2.0	2M0	TCR2BF42*	—	4.2	4M2
TCR2BF21*	TCR2BE21*	2.1	2M1	TCR2BF43*	—	4.3	4M3
TCR2BF22*	TCR2BE22*	2.2	2M2	TCR2BF44*	—	4.4	4M4
TCR2BF23*	TCR2BE23*	2.3	2M3	TCR2BF45	—	4.5	4M5
TCR2BF24*	TCR2BE24*	2.4	2M4	TCR2BF46*	—	4.6	4M6
TCR2BF25	TCR2BE25	2.5	2M5	TCR2BF47*	—	4.7	4M7
TCR2BF26*	TCR2BE26*	2.6	2M6	TCR2BF48*	—	4.8	4M8
TCR2BF27	TCR2BE27	2.7	2M7	TCR2BF49*	—	4.9	4M9
TCR2BF28	TCR2BE28	2.8	2M8	TCR2BF50	—	5.0	5M0
TCR2BF285*	TCR2BE285*	2.85	2MD				

Please contact your local Toshiba representative if you are interested in products with * sign

Marking (top view)

Example: TCR2BF33 (3.3 V output)

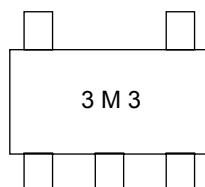

Example: TCR2BE33 (3.3 V output)

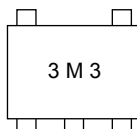

Absolute Maximum Ratings (Ta = 25°C)

Characteristics	Symbol	Rating	Unit	
Input voltage	V _{IN}	6.0	V	
Control voltage	V _{CT}	-0.3 to 6.0	V	
Output voltage	V _{OUT}	-0.3 to V _{IN} + 0.3	V	
Output current	I _{OUT}	200	mA	
Power dissipation	P _D	SMV	200 (Note 1)	mW
			380 (Note 2)	
		ESV	150 (Note 1)	
			320 (Note 3)	
Operation temperature range	T _{opr}	-40 to 85	°C	
Junction temperature	T _j	150	°C	
Storage temperature range	T _{stg}	-55 to 150	°C	

Note: Using continuously under heavy loads (e.g. the application of high temperature/current/voltage and the significant change in temperature, etc.) may cause this product to decrease in the reliability significantly even if the operating conditions (i.e. operating temperature/current/voltage, etc.) are within the absolute maximum ratings and the operating ranges.

Please design the appropriate reliability upon reviewing the Toshiba Semiconductor Reliability Handbook ("Handling Precautions"/"Derating Concept and Methods") and individual reliability data (i.e. reliability test report and estimated failure rate, etc).

Note 1: Unit Rating

Note 2: Rating at mounting on a board
(Glass epoxy board dimension: 30 mm × 30 mm, Copper area: 50 mm²)

Note 3: Rating at mounting on a board
(Glass epoxy board dimension: 30 mm × 30 mm, Copper area: 20 mm²)

Electrical Characteristics

(Unless otherwise specified,

$V_{IN} = V_{OUT} + 1\text{ V}$, $I_{OUT} = 50\text{ mA}$, $C_{IN} = 0.1\text{ }\mu\text{F}$, $C_{OUT} = 1.0\text{ }\mu\text{F}$, $T_j = 25^\circ\text{C}$)

Characteristics	Symbol	Test Condition	Min	Typ.	Max	Unit	
Output voltage	V_{OUT}	—	$V_{OUT} \leq 1.4\text{ V}$	-30	—	+30	mV
			$1.5\text{ V} \leq V_{OUT}$	-2	—	+2	%
Line regulation	Reg·line	$V_{OUT} + 0.5\text{ V} \leq V_{IN} \leq 6\text{ V}$, $I_{OUT} = 1\text{ mA}$	—	1	15	mV	
Load regulation	Reg·load	$1\text{ mA} \leq I_{OUT} \leq 150\text{ mA}$	—	10	30	mV	
Quiescent current	I_B	$I_{OUT} = 0\text{ mA}$	—	40	75	μA	
Stand-by current	I_B (OFF)	$V_{CT} = 0\text{ V}$	—	0.1	1.0	μA	
Dropout voltage	$V_{IN} - V_{OUT}$	Please refer to the Dropout voltage table					
Temperature coefficient	T_{CVO}	$-40^\circ\text{C} \leq T_{opr} \leq 85^\circ\text{C}$	—	100	—	ppm/ $^\circ\text{C}$	
Output noise voltage	V_{NO}	$V_{IN} = V_{OUT} + 1\text{ V}$, $I_{OUT} = 10\text{ mA}$, $10\text{ Hz} \leq f \leq 100\text{ kHz}$, $T_a = 25^\circ\text{C}$ (Note 4)	—	50	—	μV_{rms}	
Input voltage	V_{IN}	—	$V_{OUT} : 1.0\text{V}$	1.55	—	6.0	V
			$V_{OUT} : 1.05\text{V to } 1.1\text{V}$	$V_{OUT} + 0.50\text{ V}$	—	6.0	
			$V_{OUT} : 1.15\text{V to } 1.2\text{V}$	1.58	—	6.0	
			$V_{OUT} : 1.25\text{V}$	1.59	—	6.0	
			$V_{OUT} : 1.3\text{V}$	1.63	—	6.0	
			$V_{OUT} : 1.4\text{V}$	1.68	—	6.0	
			$V_{OUT} : 1.5\text{V to } 1.75\text{V}$	$V_{OUT} + 0.25\text{ V}$	—	6.0	
			$V_{OUT} : 1.8\text{V to } 2.4\text{V}$	$V_{OUT} + 0.20\text{ V}$	—	6.0	
			$V_{OUT} : 2.5\text{V to } 5.0\text{V}$	$V_{OUT} + 0.15\text{ V}$	—	6.0	
Ripple rejection ratio	R.R.	$V_{IN} = V_{OUT} + 1\text{ V}$, $I_{OUT} = 10\text{ mA}$, $f = 1\text{ kHz}$, $V_{Ripple} = 500\text{ mV}_{p-p}$, $T_a = 25^\circ\text{C}$	—	70	—	dB	
Control voltage (ON)	V_{CT} (ON)	—	1.1	—	6.0	V	
Control voltage (OFF)	V_{CT} (OFF)	—	0	—	0.4	V	

Note 4: The 2.8V output product.

Dropout Voltage

($I_{OUT} = 50 \text{ mA}$, $C_{IN} = 0.1 \mu\text{F}$, $C_{OUT} = 1.0 \mu\text{F}$, $T_j = 25^\circ\text{C}$)

Output voltage	Symbol	Min	Typ.	Max	Unit
$V_{OUT} : 1.0\text{V}$	$V_{IN-V_{OUT}}$	—	350	550	mV
$V_{OUT} : 1.05\text{V}$		—	340	500	
$V_{OUT} : 1.1\text{V}$		—	310	500	
$V_{OUT} : 1.15\text{V}$		—	290	430	
$V_{OUT} : 1.2\text{V}$		—	260	380	
$V_{OUT} : 1.25\text{V}$		—	250	340	
$V_{OUT} : 1.3\text{V}$		—	230	330	
$V_{OUT} : 1.4\text{V}$		—	190	280	
$V_{OUT} : 1.5\text{V to } 1.75\text{V}$		—	160	250	
$V_{OUT} : 1.8\text{V to } 2.4\text{V}$		—	130	200	
$V_{OUT} : 2.5\text{V to } 5.0\text{V}$		—	100	150	

Application Note

1. Recommended Application Circuit

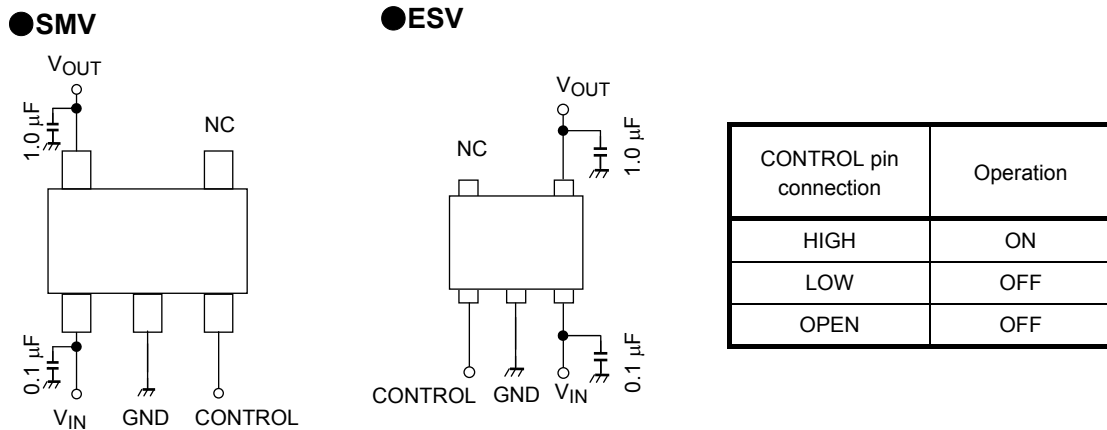

The figure above shows the recommended configuration for using a Low-Dropout regulator. Insert a capacitor at V_{OUT} and V_{IN} pins for stable input/output operation. (Ceramic capacitors can be used).

2. Power Dissipation

Power dissipation is measured on the board shown below.

Testing Board of Thermal Resistance

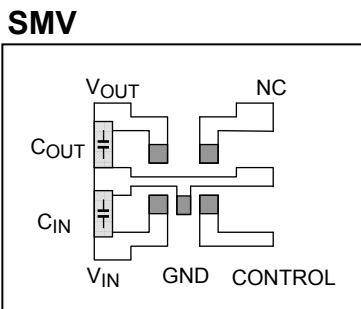

*Board material: Glass Epoxy
 Board dimension: 30 mm × 30 mm
 Copper area: 50 mm², t = 0.8 mm

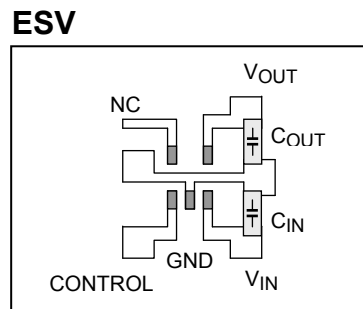

*Board material: Glass Epoxy
 Board dimension: 30 mm × 30 mm
 Copper area: 20 mm², t = 0.8 mm

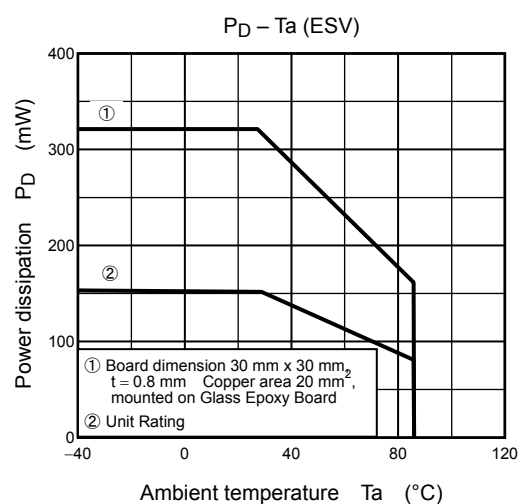
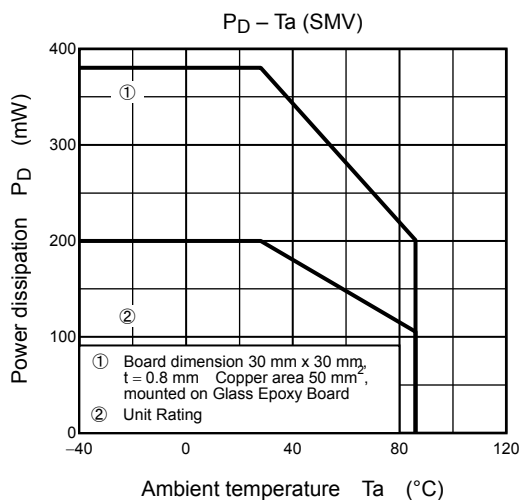

Attention in Use

- **Output Capacitors**
Ceramic capacitors can be used for these devices. However, because of the type of the capacitors, there might be unexpected thermal features. Please consider application condition for selecting capacitors. And Toshiba recommend the ESR of ceramic capacitor is under 10 Ω .
- **Mounting**
The long distance between IC and output capacitor might affect phase assurance by impedance in wire and inductor. For stable power supply, output capacitor need to mount near IC as much as possible. Also GND pattern need to be large and make the wire impedance small as possible.
- **Permissible Loss**
Please have enough design patterns for expected maximum permissible loss. And under consideration of surrounding temperature, input voltage, and output current etc, we recommend proper dissipation ratings for maximum permissible loss; in general maximum dissipation rating is 70 to 80 percent.
- **Overcurrent Protection Circuit**
Overcurrent protection circuit is designed in these products, but this does not assure for the suppression of uprising device operation. If output pins and GND pins are shorted out, these products might be break down. In use of these products, please read through and understand dissipation idea for absolute maximum ratings from the above mention or our 'Semiconductor Reliability Handbook'. Then use these products under absolute maximum ratings in any condition. Furthermore, Toshiba recommend inserting failsafe system into the design.

Representative Typical Characteristics

1) Output Voltage vs. Input Voltage

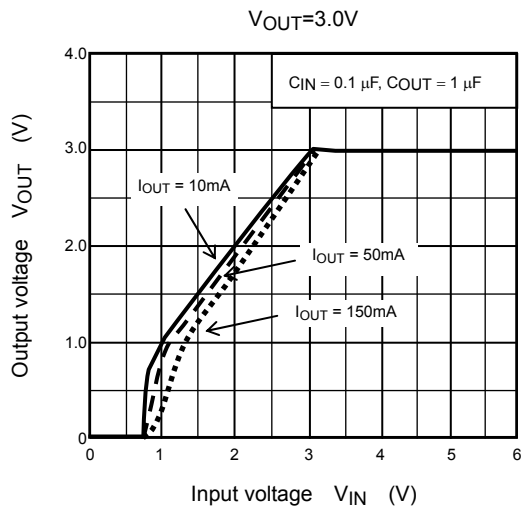
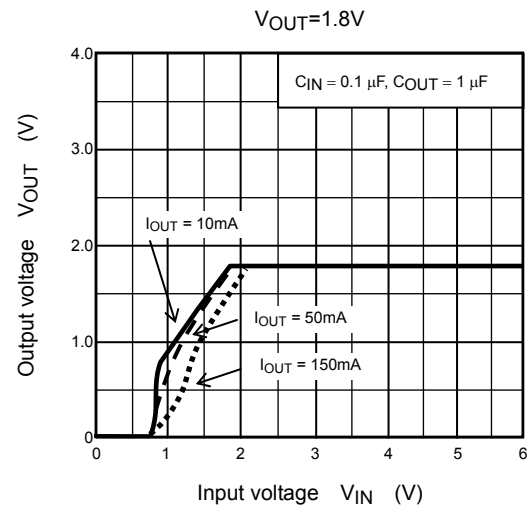
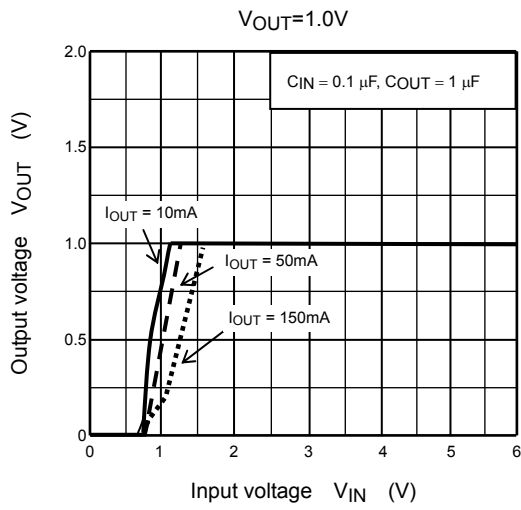

2) Output Voltage vs. Output Current

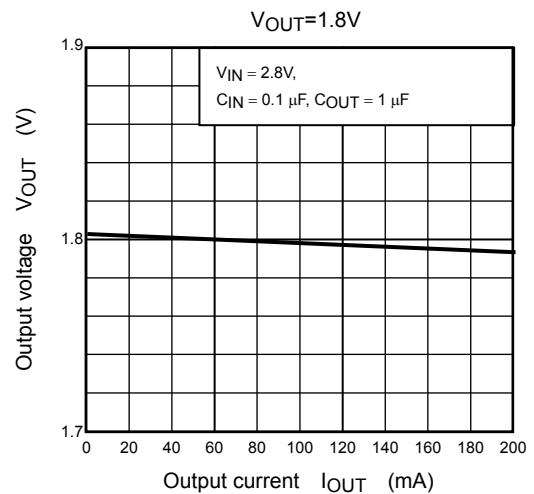
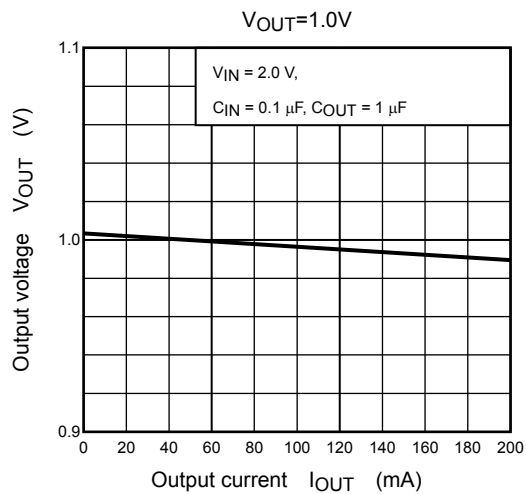

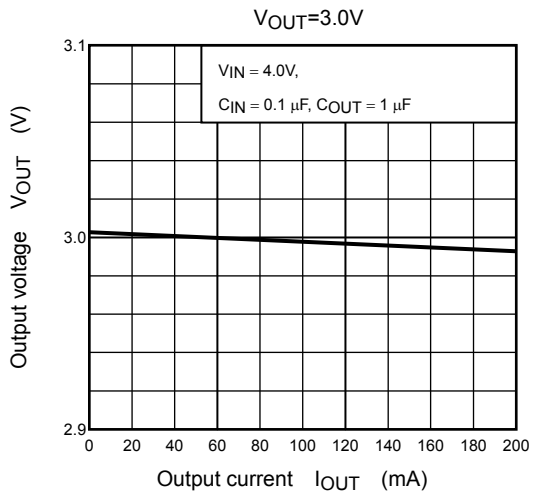

3) Output Voltage vs. Ambient Temperature

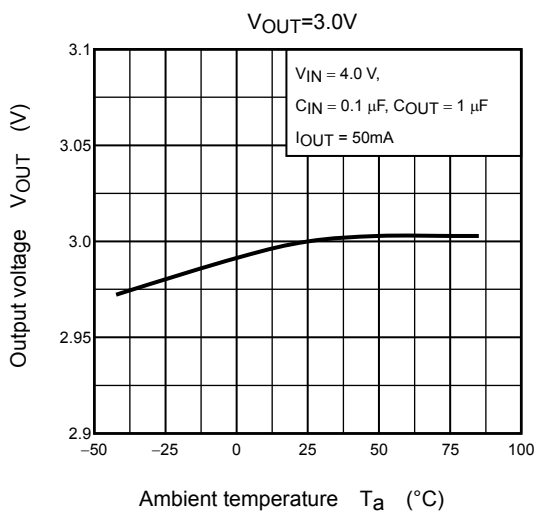
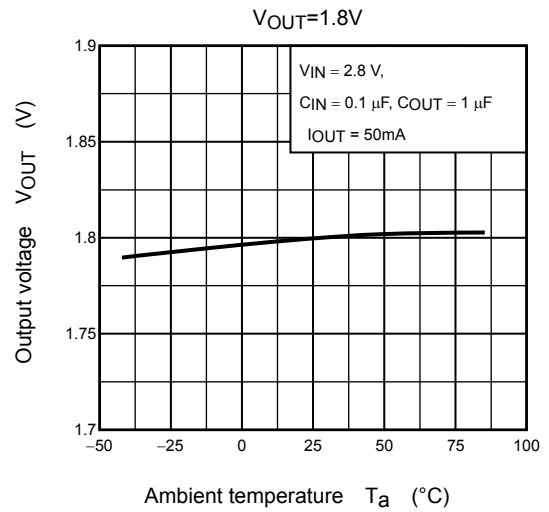
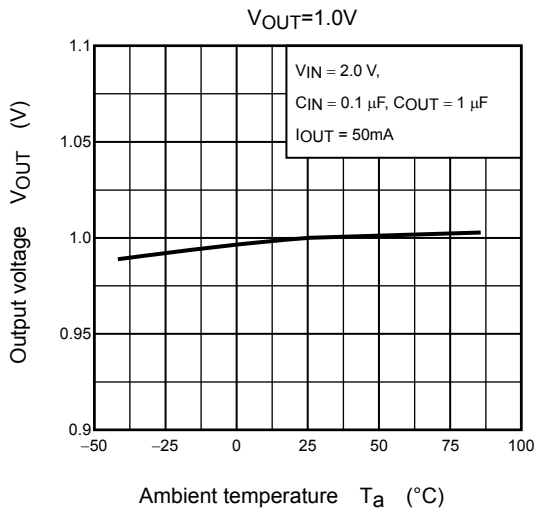

4) Dropout Voltage vs. Output Current

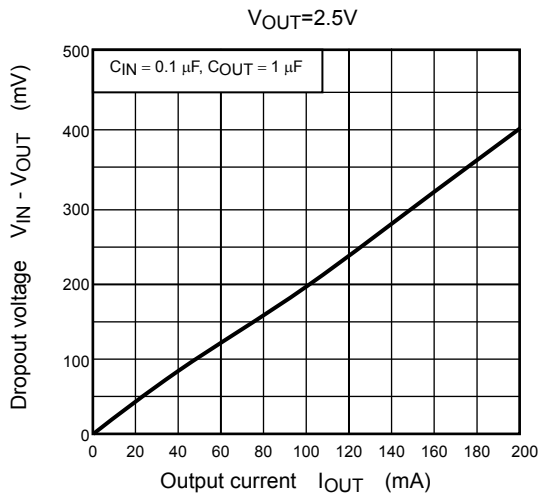
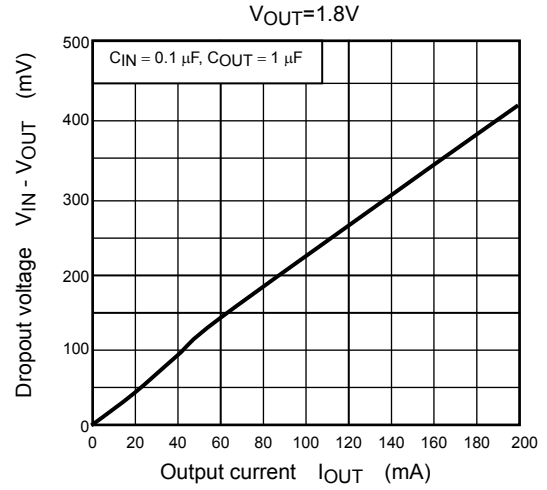
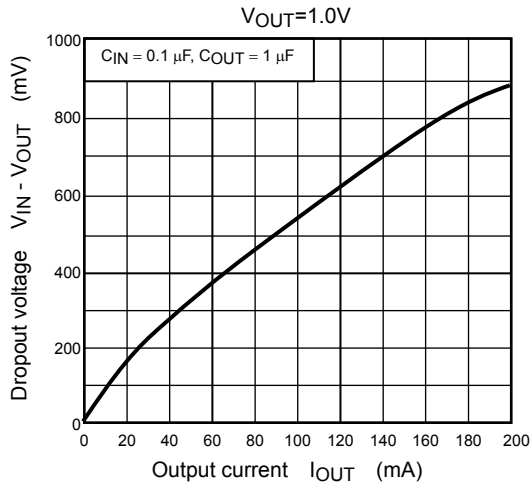

5) Quiescent Current vs. Input Voltage

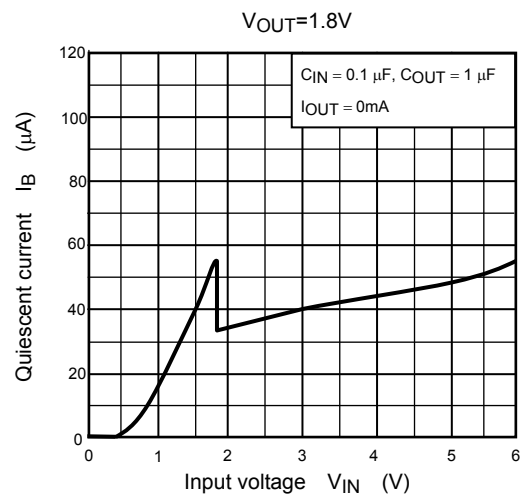
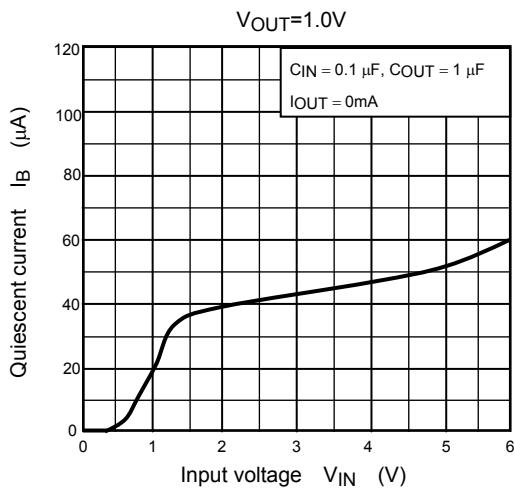

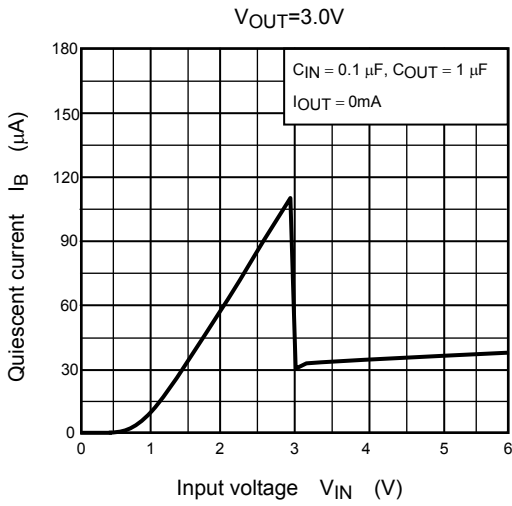

6) Quiescent Current vs.Ambient Temperature

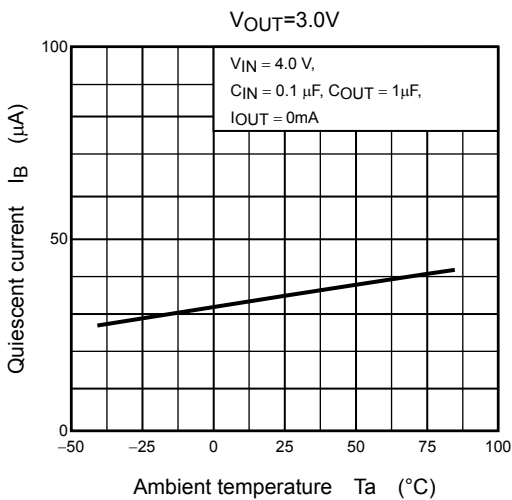
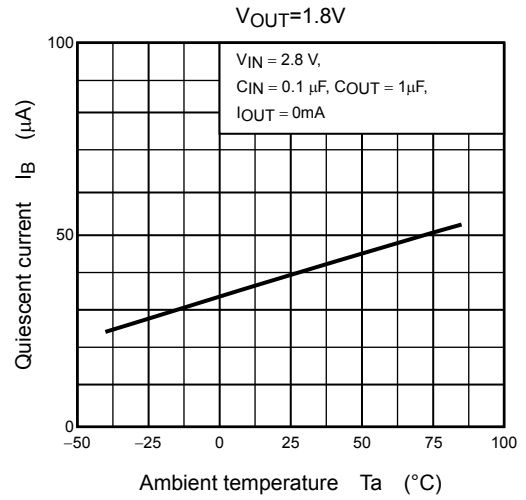
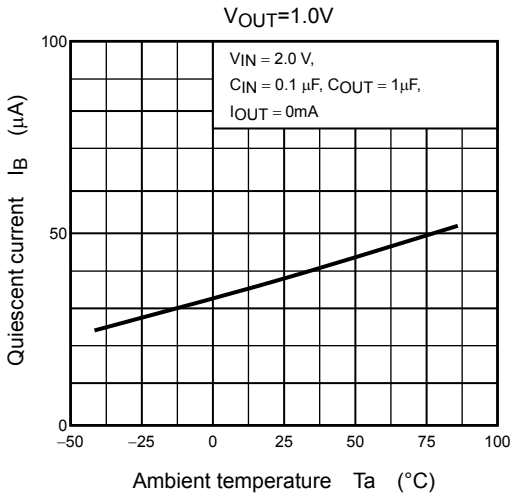

7) Overcurrent protection characteristics (Overcurrent protection characteristic does not assure for the suppression of uprising device operation. We recommend proper dissipation ratings for maximum permissible loss.)

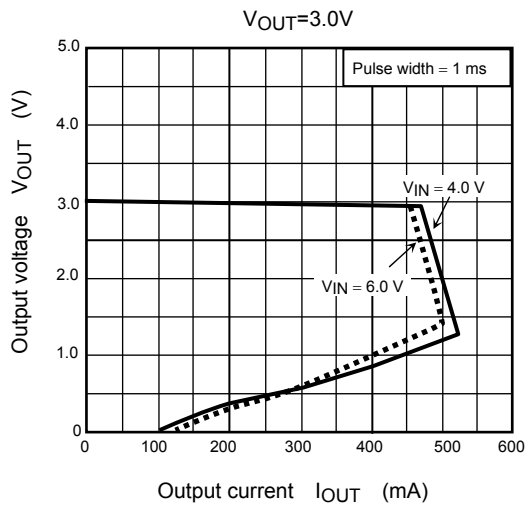
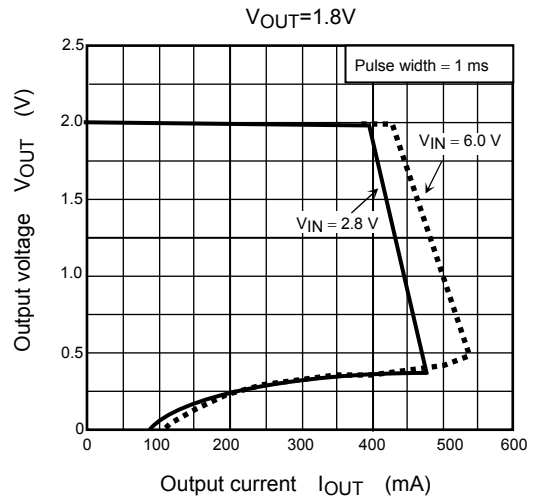
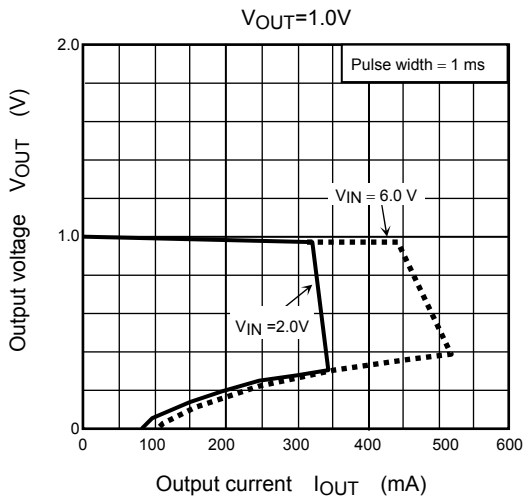

8) Ripple Rejection Ratio vs. Frequency

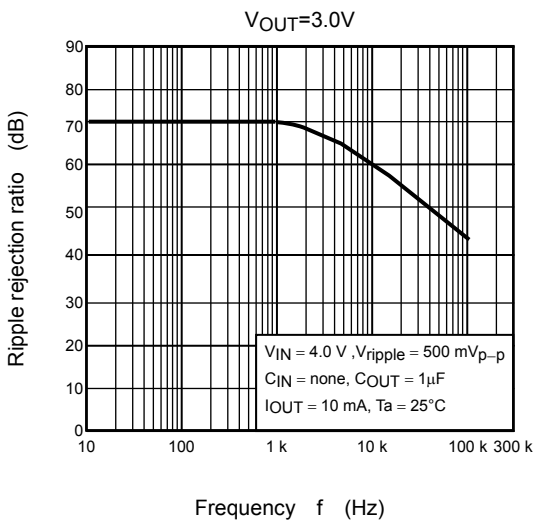

9) Control Transient Response (Auto-Discharge)

$V_{OUT}=1.0V$ (Turn on waveform)

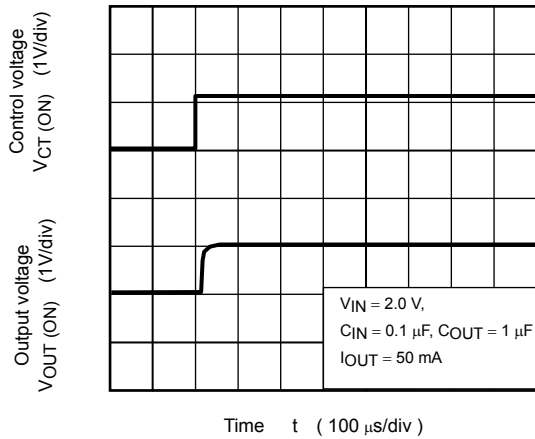

$V_{OUT}=1.0V$ (Turn off waveform)

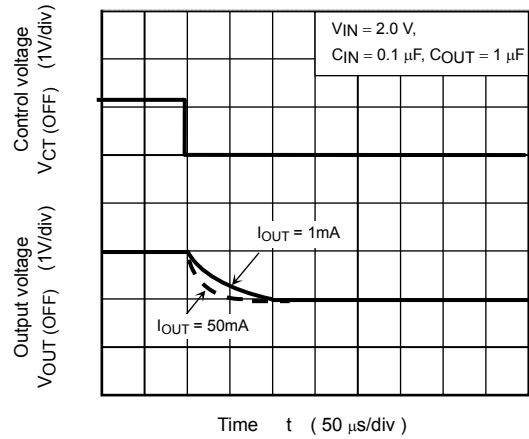

$V_{OUT}=1.8V$ (Turn on waveform)

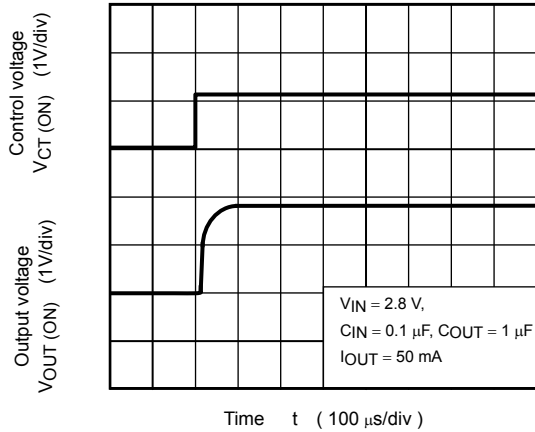

$V_{OUT}=1.8V$ (Turn off waveform)

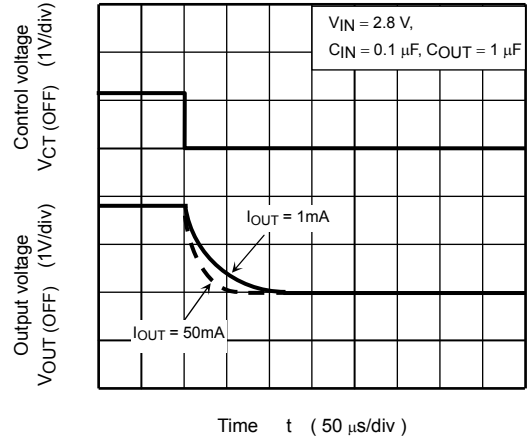

$V_{OUT}=3.0V$ (Turn on waveform)

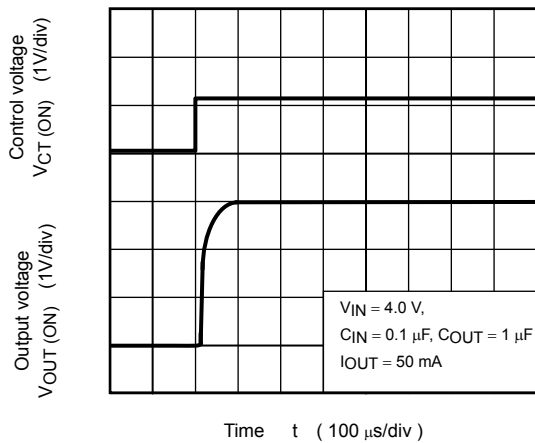

$V_{OUT}=3.0 V$ (Turn off waveform)

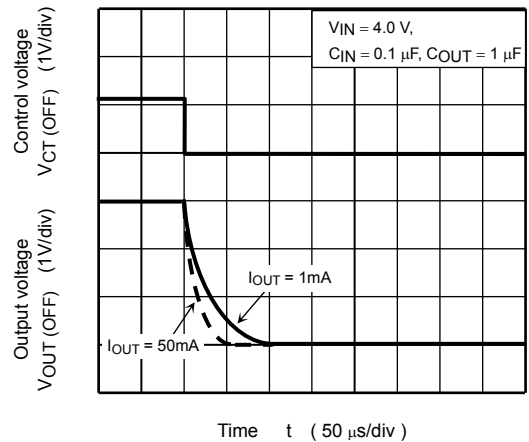

10) Load Transient Response

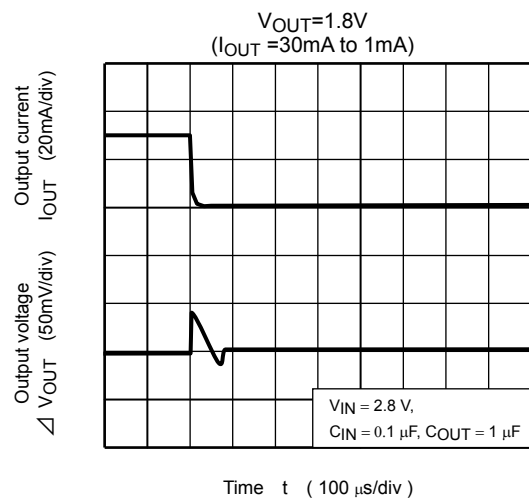
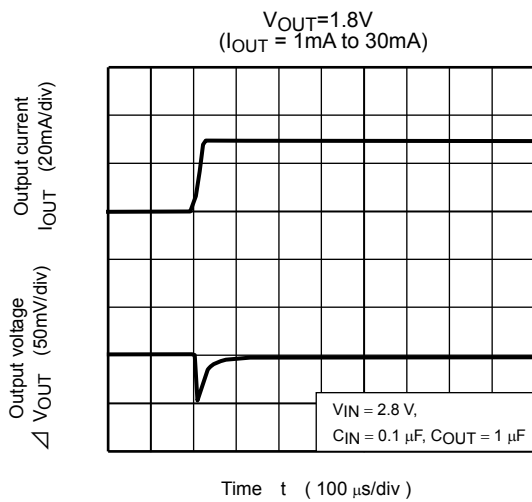
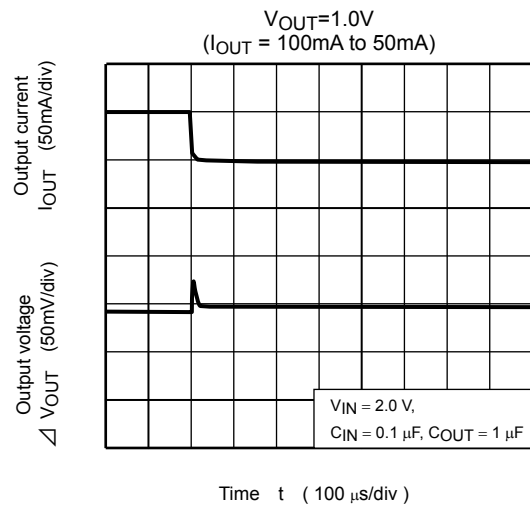
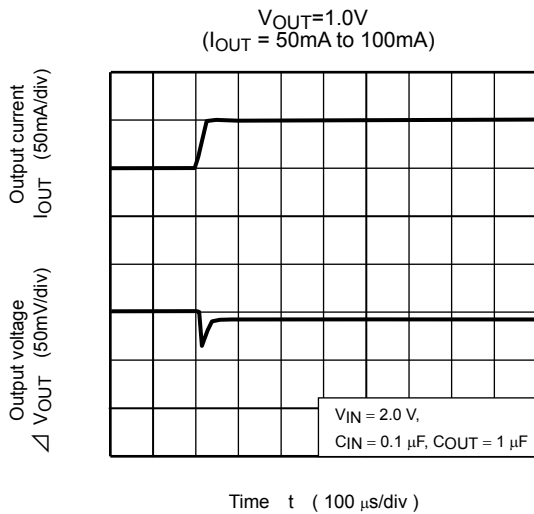
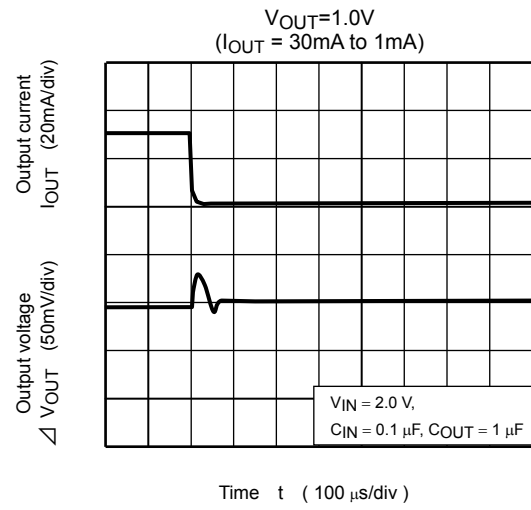
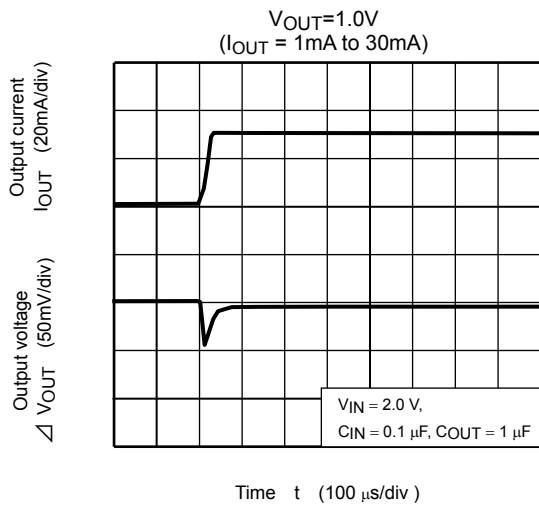

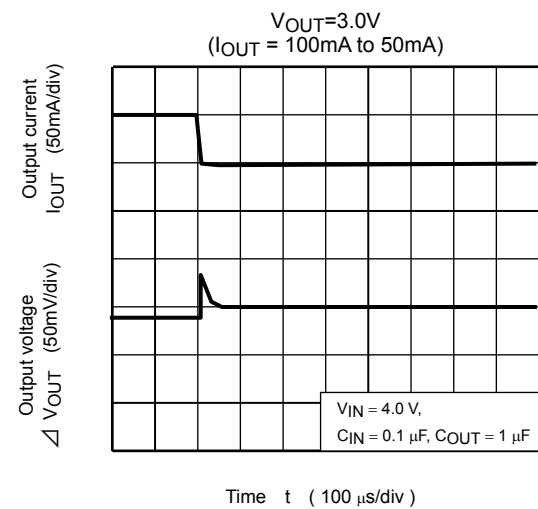
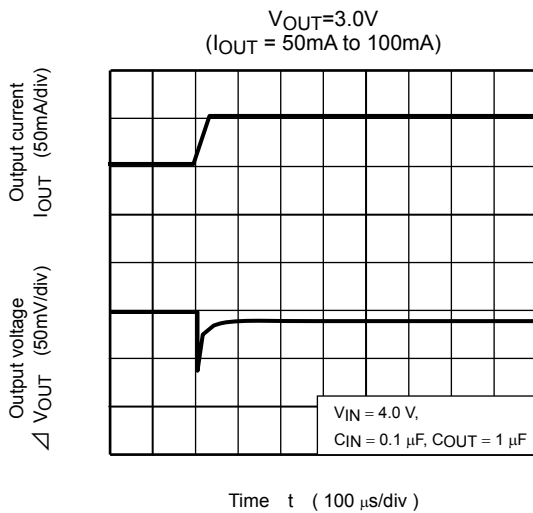
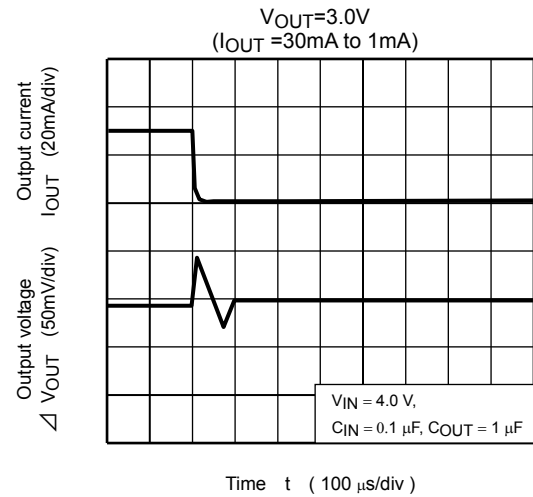
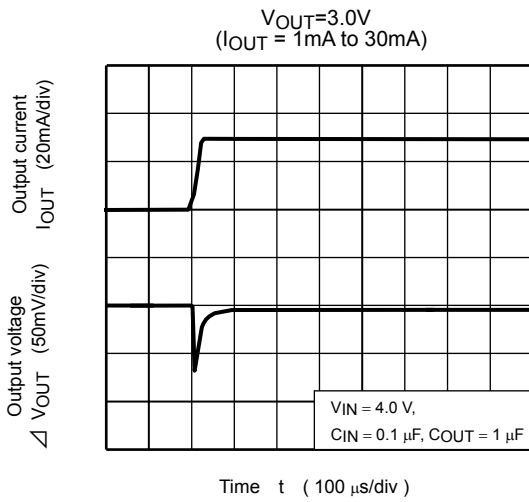
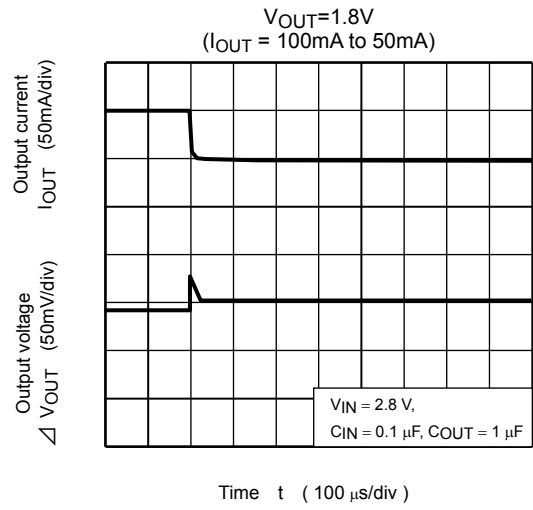
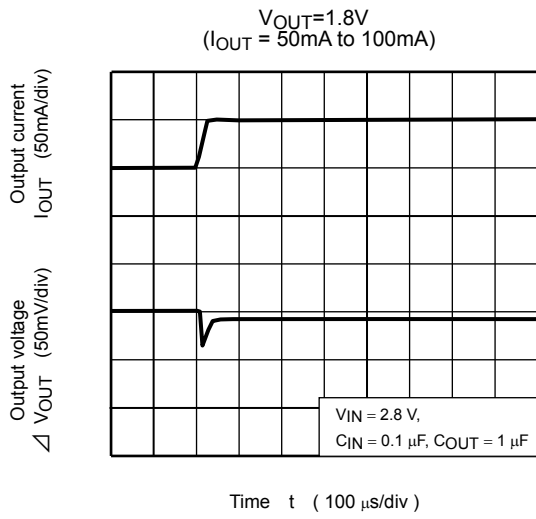

Package Dimensions SMV (SOT-25)(SC-74A)

Unit: mm

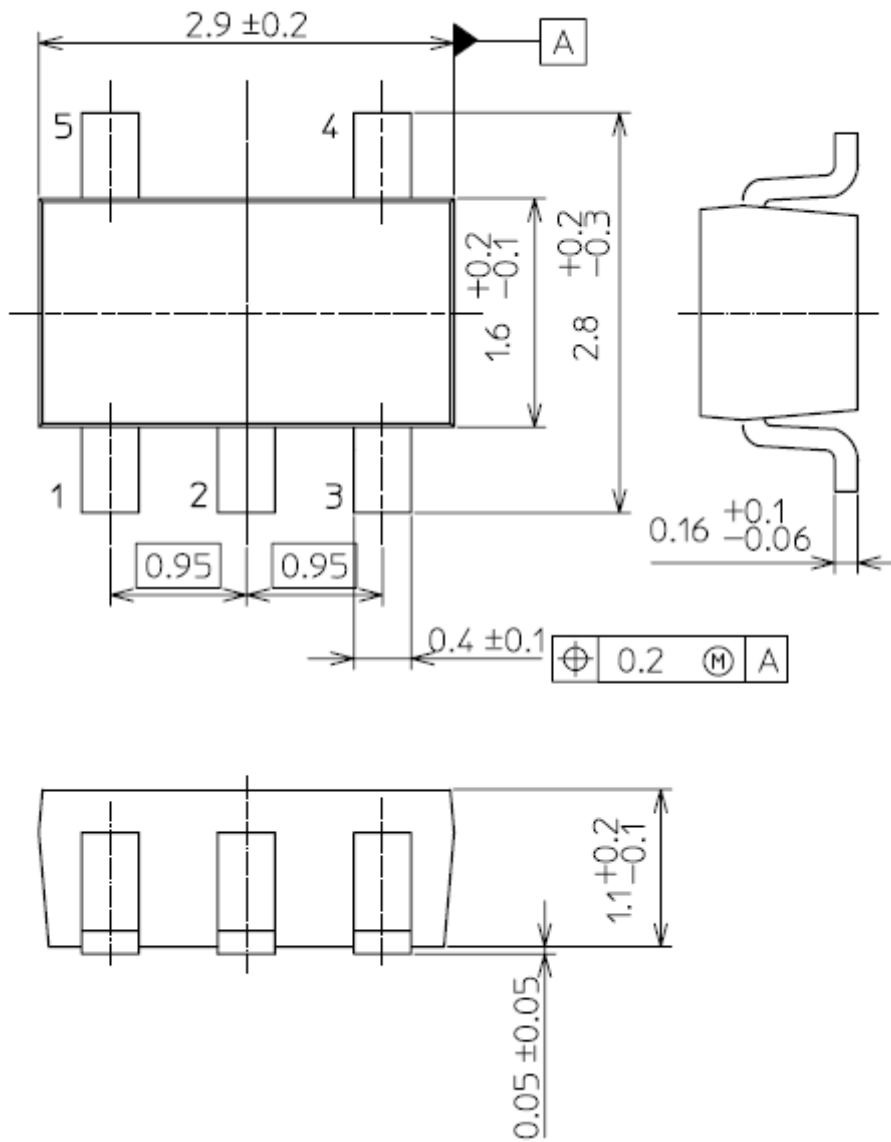

Weight : 16 mg (typ.)

Package Dimensions

ESV (SOT-553)

Unit: mm

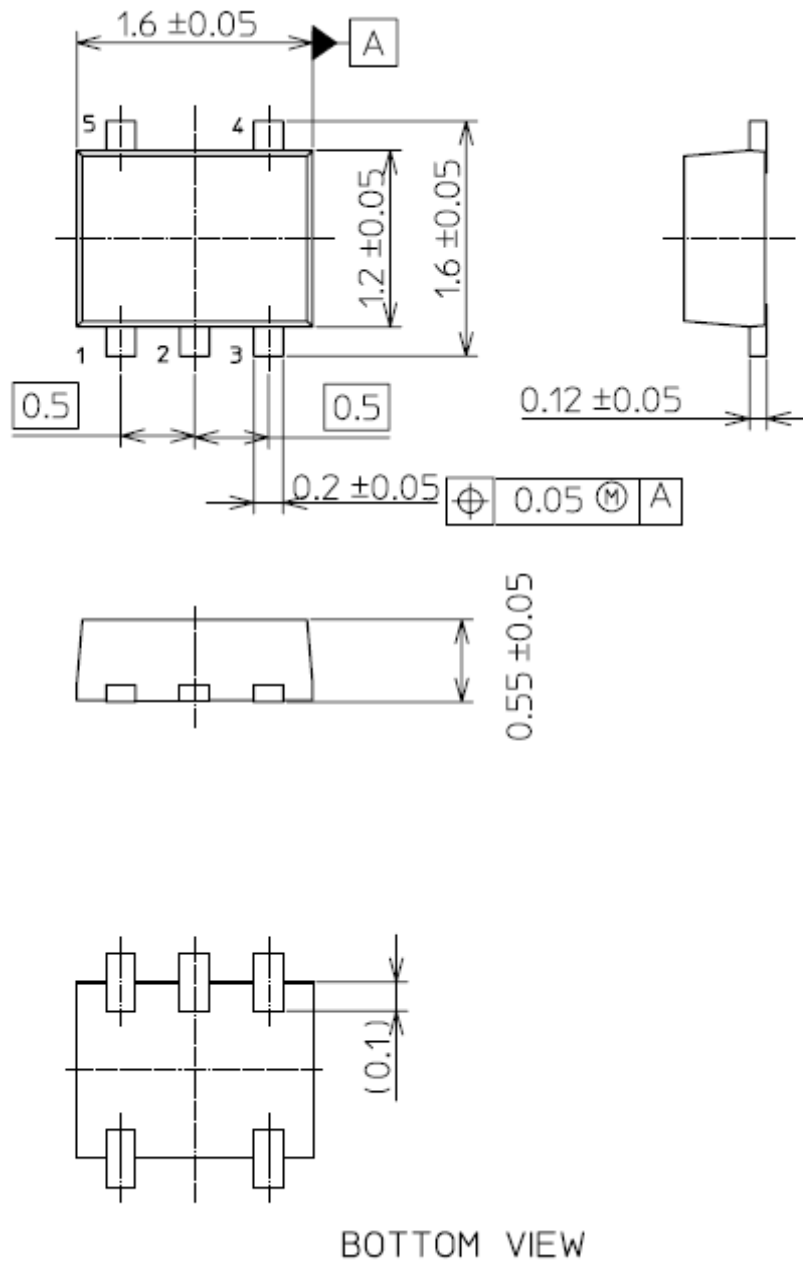

Weight: 3.0 mg (typ.)

RESTRICTIONS ON PRODUCT USE

- Toshiba Corporation, and its subsidiaries and affiliates (collectively "TOSHIBA"), reserve the right to make changes to the information in this document, and related hardware, software and systems (collectively "Product") without notice.
- This document and any information herein may not be reproduced without prior written permission from TOSHIBA. Even with TOSHIBA's written permission, reproduction is permissible only if reproduction is without alteration/omission.
- Though TOSHIBA works continually to improve Product's quality and reliability, Product can malfunction or fail. Customers are responsible for complying with safety standards and for providing adequate designs and safeguards for their hardware, software and systems which minimize risk and avoid situations in which a malfunction or failure of Product could cause loss of human life, bodily injury or damage to property, including data loss or corruption. Before customers use the Product, create designs including the Product, or incorporate the Product into their own applications, customers must also refer to and comply with (a) the latest versions of all relevant TOSHIBA information, including without limitation, this document, the specifications, the data sheets and application notes for Product and the precautions and conditions set forth in the "TOSHIBA Semiconductor Reliability Handbook" and (b) the instructions for the application with which the Product will be used with or for. Customers are solely responsible for all aspects of their own product design or applications, including but not limited to (a) determining the appropriateness of the use of this Product in such design or applications; (b) evaluating and determining the applicability of any information contained in this document, or in charts, diagrams, programs, algorithms, sample application circuits, or any other referenced documents; and (c) validating all operating parameters for such designs and applications. **TOSHIBA ASSUMES NO LIABILITY FOR CUSTOMERS' PRODUCT DESIGN OR APPLICATIONS.**
- Product is intended for use in general electronics applications (e.g., computers, personal equipment, office equipment, measuring equipment, industrial robots and home electronics appliances) or for specific applications as expressly stated in this document. Product is neither intended nor warranted for use in equipment or systems that require extraordinarily high levels of quality and/or reliability and/or a malfunction or failure of which may cause loss of human life, bodily injury, serious property damage or serious public impact ("Unintended Use"). Unintended Use includes, without limitation, equipment used in nuclear facilities, equipment used in the aerospace industry, medical equipment, equipment used for automobiles, trains, ships and other transportation, traffic signaling equipment, equipment used to control combustions or explosions, safety devices, elevators and escalators, devices related to electric power, and equipment used in finance-related fields. Do not use Product for Unintended Use unless specifically permitted in this document.
- Do not disassemble, analyze, reverse-engineer, alter, modify, translate or copy Product, whether in whole or in part.
- Product shall not be used for or incorporated into any products or systems whose manufacture, use, or sale is prohibited under any applicable laws or regulations.
- The information contained herein is presented only as guidance for Product use. No responsibility is assumed by TOSHIBA for any infringement of patents or any other intellectual property rights of third parties that may result from the use of Product. No license to any intellectual property right is granted by this document, whether express or implied, by estoppel or otherwise.
- **ABSENT A WRITTEN SIGNED AGREEMENT, EXCEPT AS PROVIDED IN THE RELEVANT TERMS AND CONDITIONS OF SALE FOR PRODUCT, AND TO THE MAXIMUM EXTENT ALLOWABLE BY LAW, TOSHIBA (1) ASSUMES NO LIABILITY WHATSOEVER, INCLUDING WITHOUT LIMITATION, INDIRECT, CONSEQUENTIAL, SPECIAL, OR INCIDENTAL DAMAGES OR LOSS, INCLUDING WITHOUT LIMITATION, LOSS OF PROFITS, LOSS OF OPPORTUNITIES, BUSINESS INTERRUPTION AND LOSS OF DATA, AND (2) DISCLAIMS ANY AND ALL EXPRESS OR IMPLIED WARRANTIES AND CONDITIONS RELATED TO SALE, USE OF PRODUCT, OR INFORMATION, INCLUDING WARRANTIES OR CONDITIONS OF MERCHANTABILITY, FITNESS FOR A PARTICULAR PURPOSE, ACCURACY OF INFORMATION, OR NONINFRINGEMENT.**
- Do not use or otherwise make available Product or related software or technology for any military purposes, including without limitation, for the design, development, use, stockpiling or manufacturing of nuclear, chemical, or biological weapons or missile technology products (mass destruction weapons). Product and related software and technology may be controlled under the Japanese Foreign Exchange and Foreign Trade Law and the U.S. Export Administration Regulations. Export and re-export of Product or related software or technology are strictly prohibited except in compliance with all applicable export laws and regulations.
- Please contact your TOSHIBA sales representative for details as to environmental matters such as the RoHS compatibility of Product. Please use Product in compliance with all applicable laws and regulations that regulate the inclusion or use of controlled substances, including without limitation, the EU RoHS Directive. TOSHIBA assumes no liability for damages or losses occurring as a result of noncompliance with applicable laws and regulations.