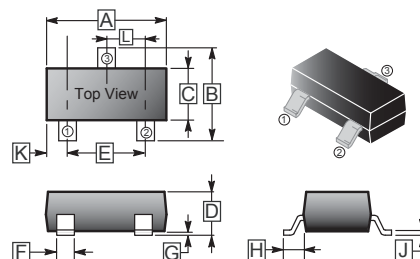


RoHS Compliant Product  
A suffix of "-C" specifies halogen & lead-free

### FEATURES

- R<sub>DS(ON)</sub>, V<sub>GS</sub>@10V, I<sub>DS</sub>@500mA=3Ω
- R<sub>DS(ON)</sub>, V<sub>GS</sub>@4.5V, I<sub>DS</sub>@200mA=4Ω
- Advanced Trench Process Technology
- High Density Cell Design For Ultra Low On-Resistance
- Very Low Leakage Current In Off Condition
- Specially Designed for Battery Operated Systems, Solid-State Relays Drivers : Relays, Displays, Lamps, Solenoids, Memories, etc.
- ESD Protected 2KV HBM
- In compliance with EU RoHS 2002/95/EC directives

### SOT-323



### MECHANICAL DATA

- Case: SOT-323 Package
- Terminals: Solderable per MIL-STD-750, Method 2026

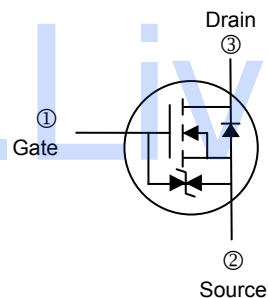
REF.	Millimeter		REF.	Millimeter	
	Min.	Max.		Min.	Max.
A	1.80	2.20	G	0.100 REF.	
B	1.80	2.45	H	0.525 REF.	
C	1.15	1.35	J	0.08	0.25
D	0.80	1.10	K	-	-
E	1.20	1.40	L	0.650 TYP.	
F	0.20	0.40			

### MARKING

K72

### PACKAGE INFORMATION

Package	MPQ	LeaderSize
SOT-323	3K	7' inch



### ABSOLUTE MAXIMUM RATINGS (T<sub>A</sub> = 25°C unless otherwise specified)

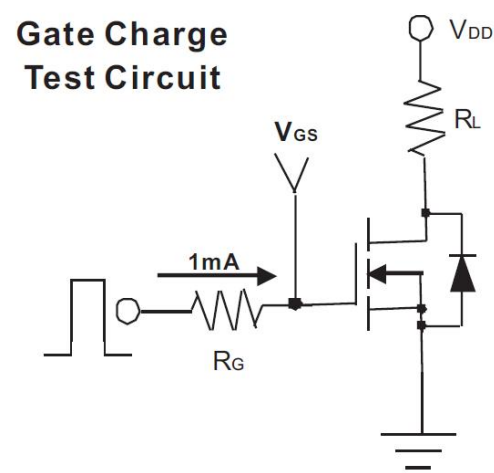
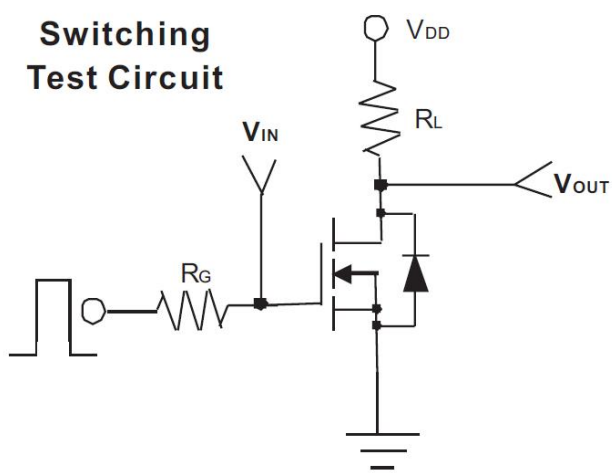
Parameter	Symbol	Rating	Unit
Drain-Source Voltage	V <sub>DS</sub>	60	V
Gate-Source Voltage	V <sub>GS</sub>	±20	V
Continuous Drain Current	I <sub>D</sub>	115	mA
Pulsed Drain Current <sup>1</sup>	I <sub>DM</sub>	800	mA
Maximum Power Dissipation	P <sub>D</sub>	T <sub>A</sub> =25°C	200
		T <sub>A</sub> =75°C	120
Thermal Resistance Junction-Ambient (PCB mounted) <sup>2</sup>	R <sub>θJA</sub>	625	°C / W
Operating Junction and Storage Temperature	T <sub>J</sub> , T <sub>STG</sub>	-55~150	°C

Notes:

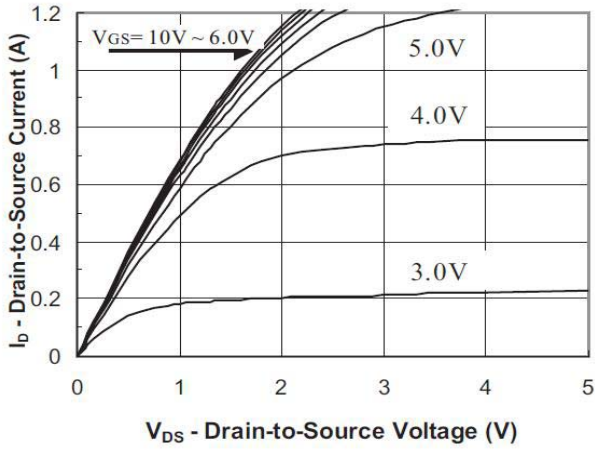
1. Maximum DC current limited by the package.
2. Surface mounted on FR4 board, t < 5sec.

**N-CHANNEL ELECTRICAL CHARACTERISTICS** ( $T_A = 25^\circ\text{C}$  unless otherwise specified)

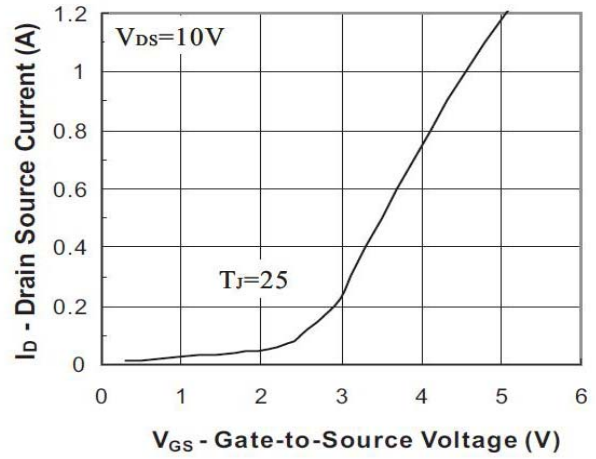
Parameter	Symbol	Min.	Typ. <sup>2</sup>	Max.	Unit	Test Conditions
<b>Static</b>						
Drain-Source Breakdown Voltage	$BV_{DSS}$	60	-	-	V	$V_{GS}=0, I_D=10\mu\text{A}$
Gate-Threshold Voltage	$V_{GS(th)}$	1	-	2.5	V	$V_{DS}=V_{GS}, I_D=250\mu\text{A}$
Drain-Source On-Resistance	$R_{DS(ON)}$	-	-	4	$\Omega$	$V_{GS}=4.5\text{V}, I_D=200\text{mA}$
		-	-	3		$V_{GS}=10\text{V}, I_D=500\text{mA}$
Zero Gate Voltage Drain Current	$I_{DSS}$	-	-	1	$\mu\text{A}$	$V_{DS}=60\text{V}, V_{GS}=0$
Gate-Body Leakage Current	$I_{GSS}$	-	-	$\pm 10$	$\mu\text{A}$	$V_{DS}=0, V_{GS}=\pm 20\text{V}$
Forward Transconductance	$g_{fs}$	100	-	-	mS	$V_{DS}=15\text{V}, I_D=250\text{mA}$
<b>Dynamic</b>						
Total Gate Charge	$Q_g$	-	-	0.8	nC	$V_{DS}=15\text{V}, V_{GS}=4.5\text{V}, I_D=200\text{mA}$
Turn-On Time	$t_{(on)}$	-	-	20	nS	$V_{DD}=30\text{V}, R_L=150\Omega, I_D=200\text{mA}, V_{GEN}=10\text{V}, R_G=10\Omega$
Turn-Off Time	$t_{(off)}$	-	-	40		
Input Capacitance	$C_{iss}$	-	-	35	pF	$V_{DS}=25\text{V}, V_{GS}=0\text{V}, f=1\text{MHz}$
Output Capacitance	$C_{oss}$	-	-	10		
Reverse Transfer Capacitance	$C_{rss}$	-	-	5		
<b>Source-Drain Diode</b>						
Diode Forward Voltage	$V_{SD}$	-	0.82	1.3	V	$I_S=200\text{mA}, V_{GS}=0\text{V}$
Continuous Diode Forward Current	$I_S$	-	-	115	mA	
Pulse Diode Forward Current	$I_{SM}$	-	-	800	mA	



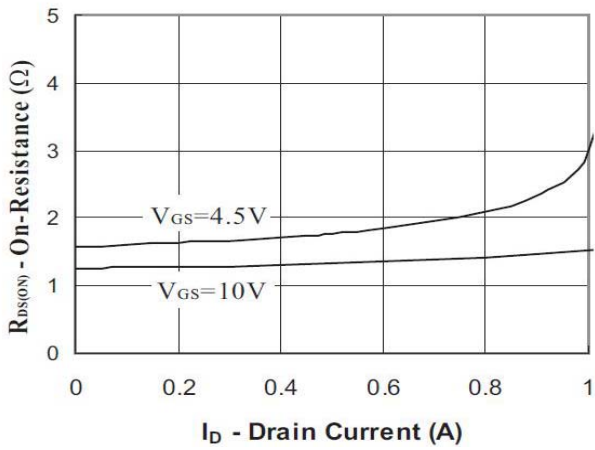
**CHARACTERISTIC CURVE**



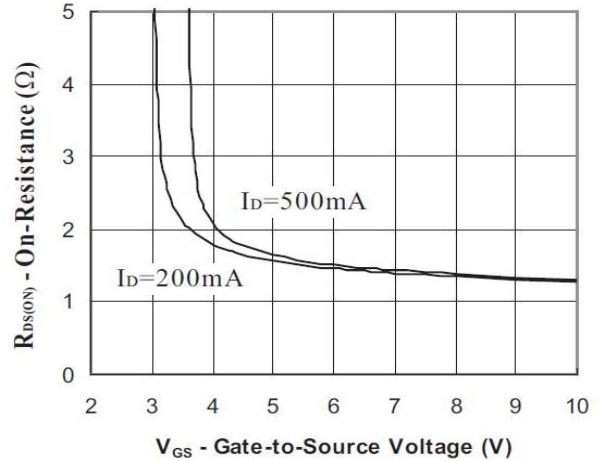
**FIG.1-Output Characteristic**



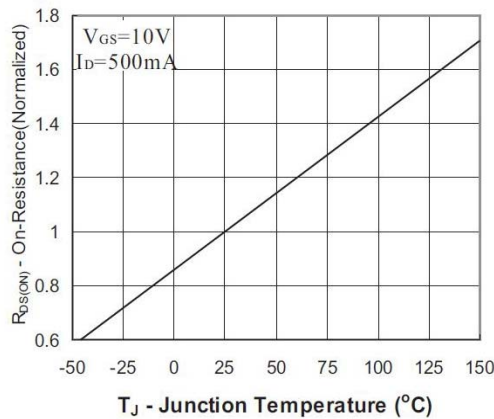
**FIG.2-Transfer Characteristic**



**FIG.3-On Resistance vs Drain Current**

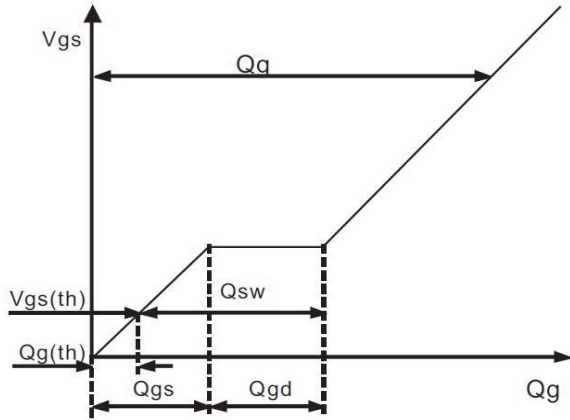


**FIG.4- On Resistance vs Gate to Source Voltage**

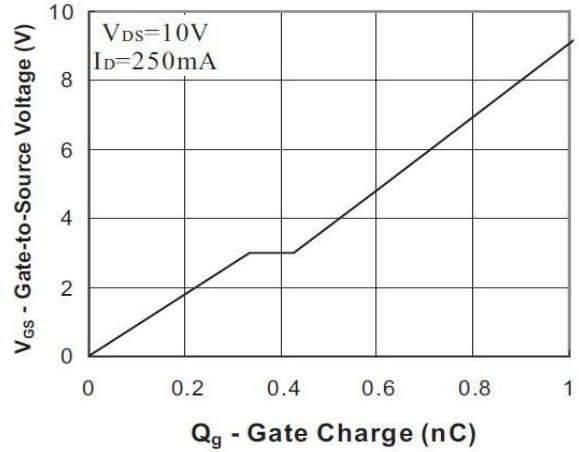


**FIG.5-On Resistance vs Junction Temperature**

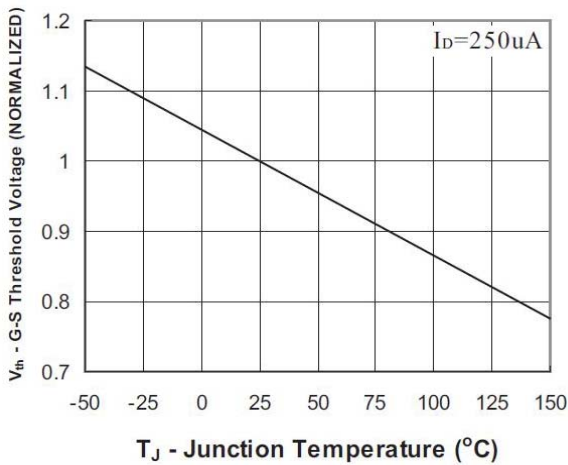
**CHARACTERISTIC CURVE**



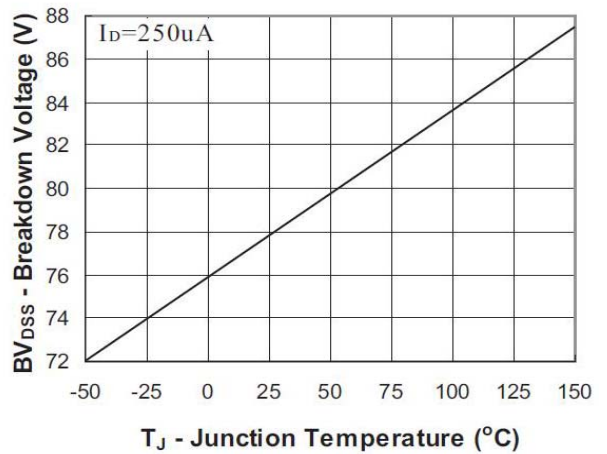
**FIG.6-Gate Charge Waveform**



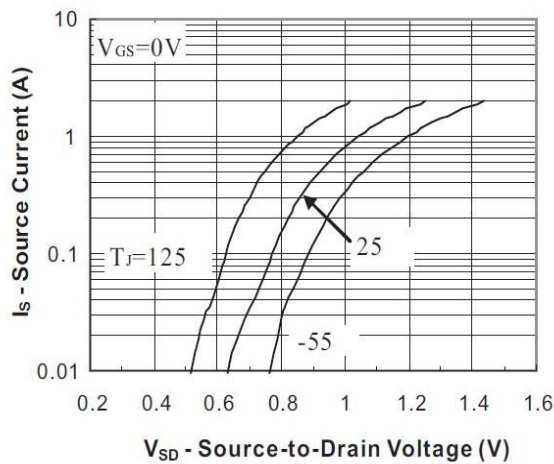
**FIG.7-Gate Charge**



**FIG.8-Threshold Voltage vs Temperature**



**FIG.9-Breakdown Voltage vs Junction Temperature**



**FIG.10-Source-Drain Diode Forward Voltage**