

Fixed Frequency White LED Step-Up Converter

Features

- Inherently Matched LED Current
- High Efficiency: 87%
- Drives Up to Five LEDs from 2.5V Supply
- 24V Internal Power Switch
- Fast 1MHz Switching Frequency
- Uses Tiny 1mm Tall Inductors
- Requires Only 1μF Output Capacitors
- 19.5V Over Voltage Protection
- SOT-23-6 Package

Applications

- White LED Backlight Display for PDA
- Pocket PC
- Smart Phones
- Handheld Devices
- Cellular Phones

General Description

The G5121 is a step-up DC/DC converter specifically designed to drive up to 5 series white LEDs with constant current. Series connection of the LEDs provides identical LED currents resulting in uniform brightness and eliminates the need for ballast resistors. The G5121 switches at 1MHz, allowing the use of tiny external components. A low 0.254V feedback voltage minimizes power loss in the current setting resistor for high efficiency. The OVP pin monitors the output voltage and turns off the converter whenever the LEDs are open.

The G5121 is available in low profile SOT-23-6 package.

Ordering Information

ORDER NUMBER	MARKING	TEMP. RANGE	PACKAGE (Pb free)
G5121TB1U	5121x	-40°C ~ +85°C	SOT-23-6

Note: TB : SOT23-6

U: Tape & Reel

Pin Configuration

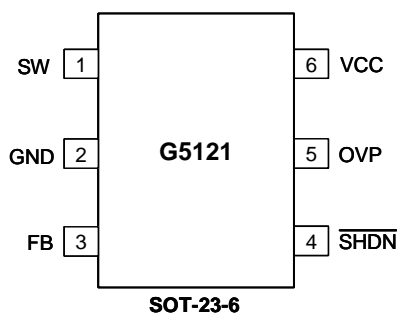

Typical Application Circuit

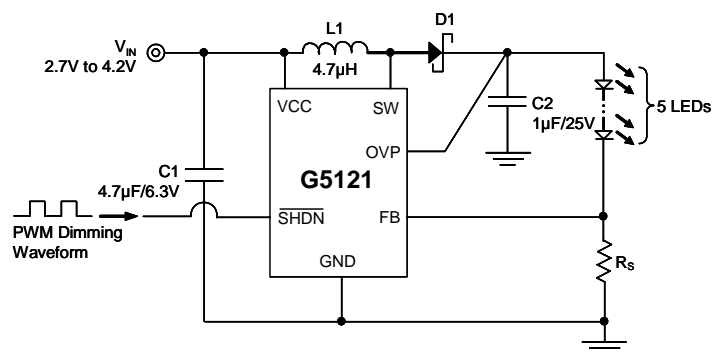

C1:TAIYO YUDEN, JMK212BJ475KD
 C2:TAIYO YUDEN, TMK316BJ105KD

**Absolute Maximum Ratings**

VCC, $\overline{\text{SHDN}}$ to GND.....-0.3V to +7V
 FB to GND.....-0.3V to VCC
 SW, OVP to GND.....-0.3V to +24V
 Operating Temperature.....-40°C to 85°C

Junction Temperature.....125°C
 Storage Temperature.....-65°C to 150°C
 Reflow Temperature (soldering, 10sec).....260°C
 ESD Rating (Human Body Model).....2kV

Stress beyond those listed under “Absolute Maximum Rating” may cause permanent damage to the device.

Electrical Characteristics

($V_{CC}=V_{\overline{\text{SHDN}}}=3.6\text{V}$, $T_A=25^\circ\text{C}$)

PARAMETER	CONDITIONS	MIN	TYP	MAX	UNITS
Input Voltage Range		2.5	---	6	V
Input Voltage UVLO		1.7	2.0	2.3	V
Over Voltage Protection Threshold	trigger	18.5	19.5	21	V
Over Voltage Protection Threshold	release	13.5	15	16.5	V
OVP Pin Input Current	$V_{\text{ovp}} = 16\text{V}$	---	40	60	μA
Quiescent Current	$V_{\text{FB}} = 0.3\text{V}$ (no switching)	---	80	120	μA
	$V_{\text{FB}} = 0.2\text{V}$ (switching)	---	---	2	mA
	$V_{\overline{\text{SHDN}}} = 0\text{V}$	---	0.1	1	μA
FB Comparator Trip Point	Initial Accuracy	244	254	264	mV
	Temperature Coefficient	---	100	---	ppm/°C
Switching Frequency	$V_{\text{FB}} = 0.2\text{V}$	0.8	1.0	1.2	MHz
Maximum Duty		85	---	---	%
Switch $R_{\text{DS(ON)}}$	$I_{\text{SW}} = 150\text{mA}$	---	0.7	1.0	Ω
Switch Leakage Current	$V_{\text{SW}} = 20\text{V}$	---	0.1	10	μA
Switch Current Limit		500	600	700	mA
Soft Start Time		---	120	---	μs
$\overline{\text{SHDN}}$ Pin Voltage High		2	---	---	V
$\overline{\text{SHDN}}$ Pin Voltage Low		---	---	0.8	V

Typical Performance Characteristics

($V_{CC} = +3.6V$, $V_{SHDN} = +3.6V$, $L = 4.7\mu H$, $T_A = 25^\circ C$, unless otherwise noted.)

Stability for Driving 5 WLEDs

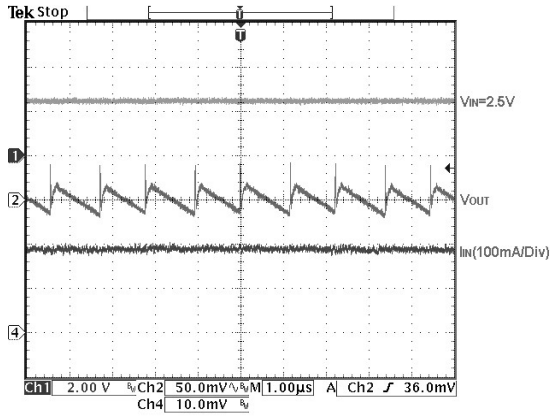

Stability for Driving 4 WLEDs

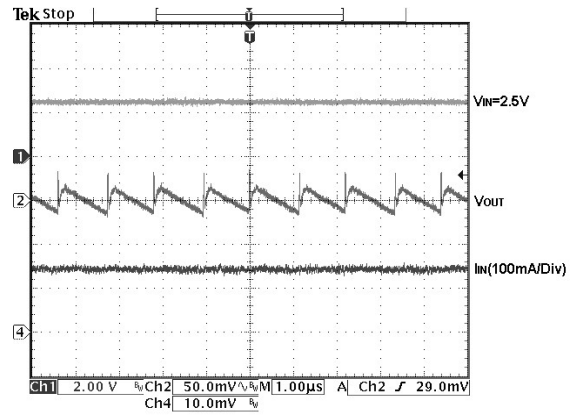

Stability for Driving 3 WLEDs

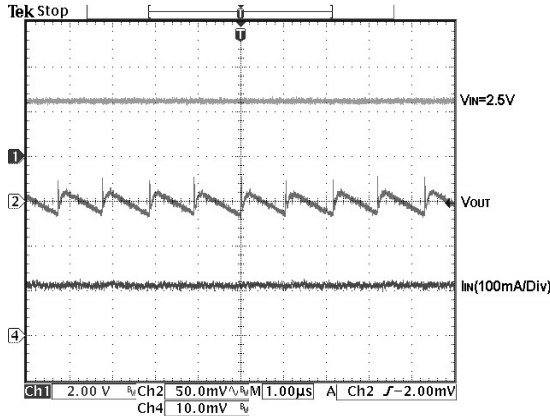

Stability for Driving 2 WLEDs

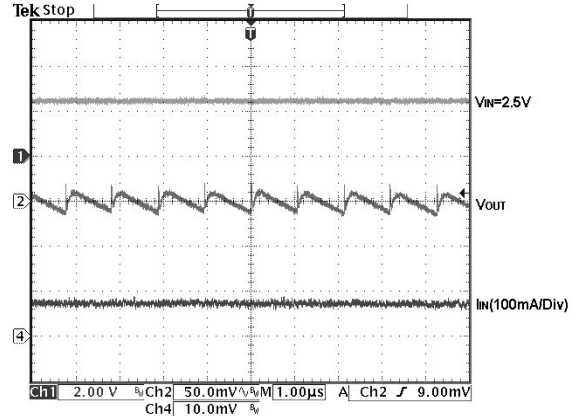

Inrush Current for Driving 5 WLEDs

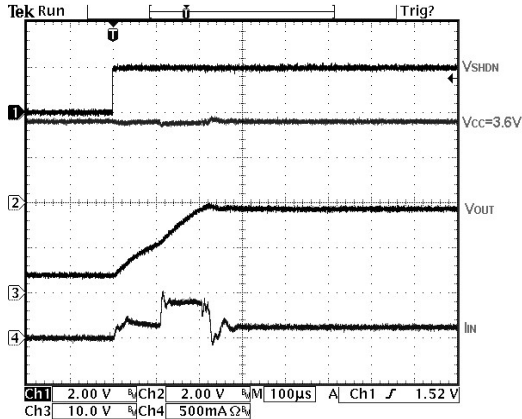

Inrush Current for Driving 4 WLEDs

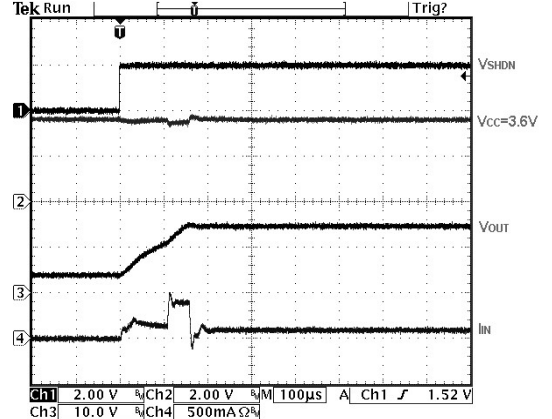

Typical Performance Characteristics (continued)

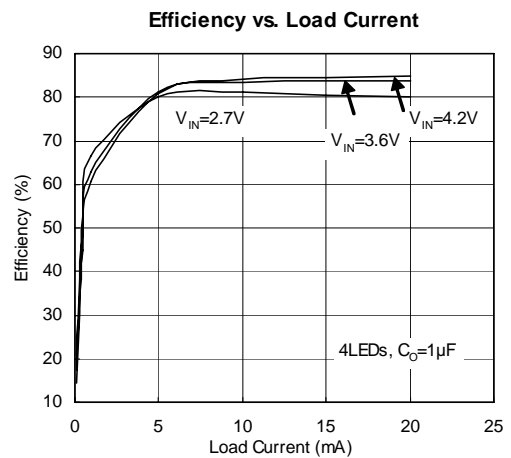
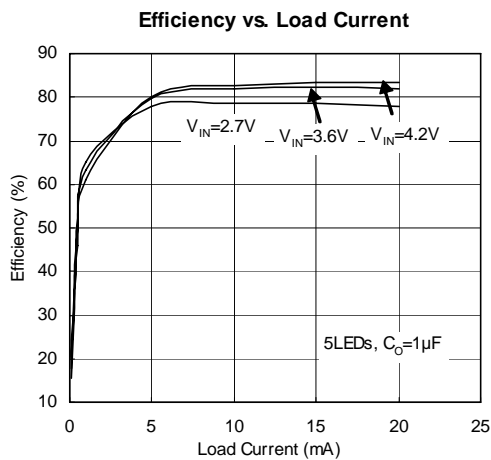
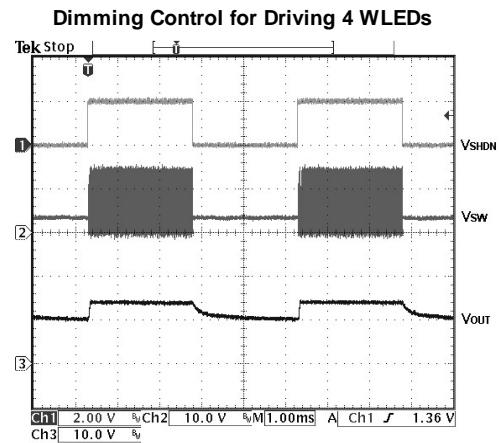
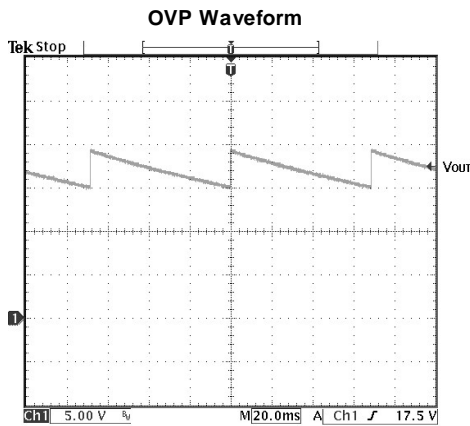
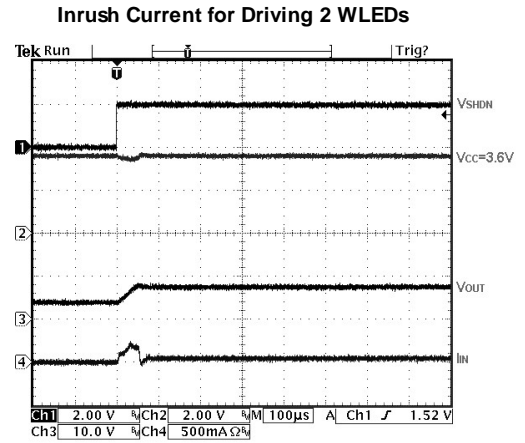
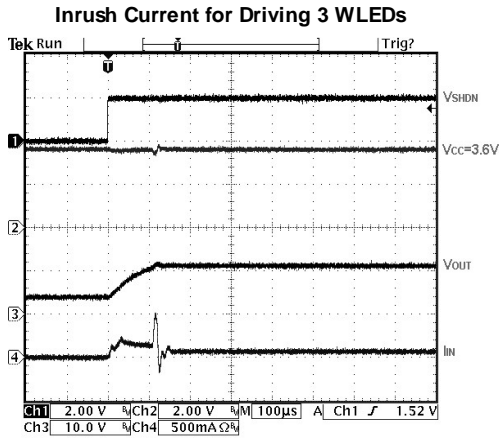

Typical Performance Characteristics (continued)

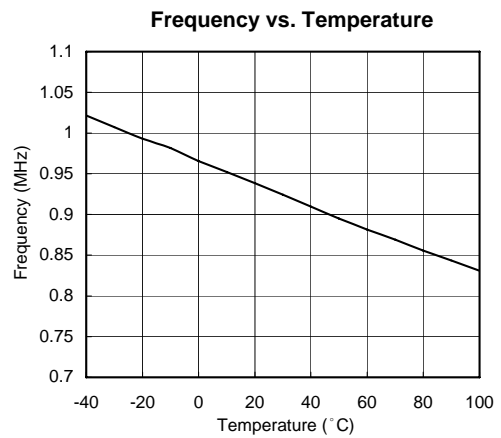
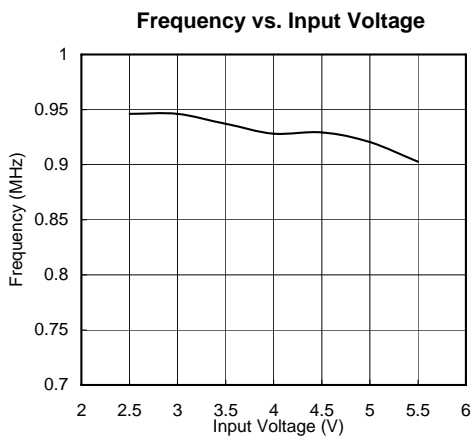
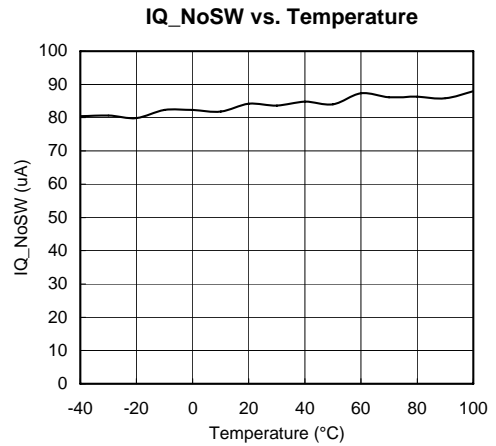
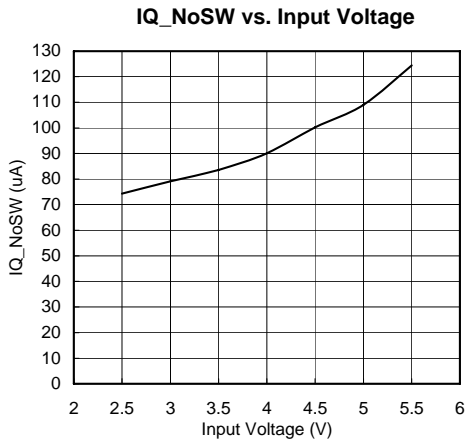
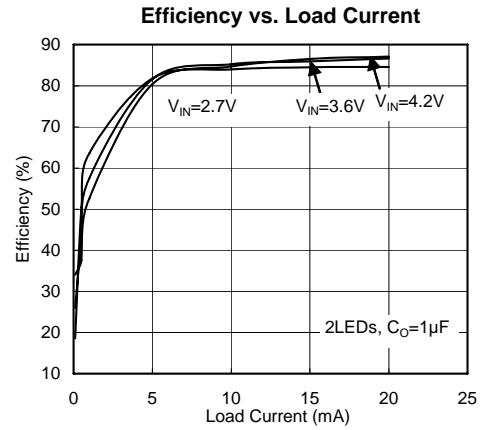
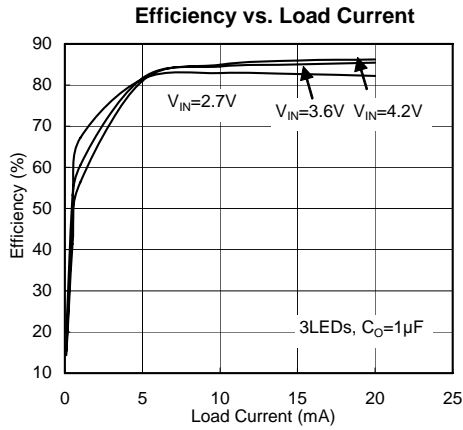

Typical Performance Characteristics (continued)

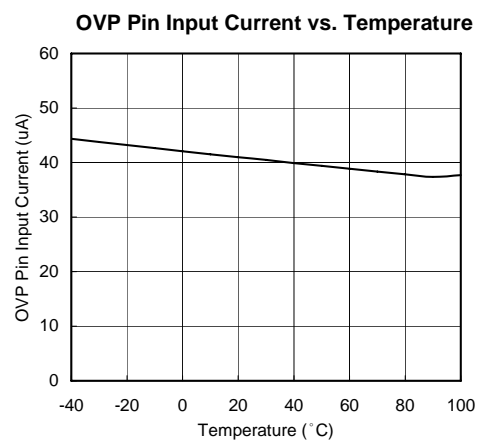
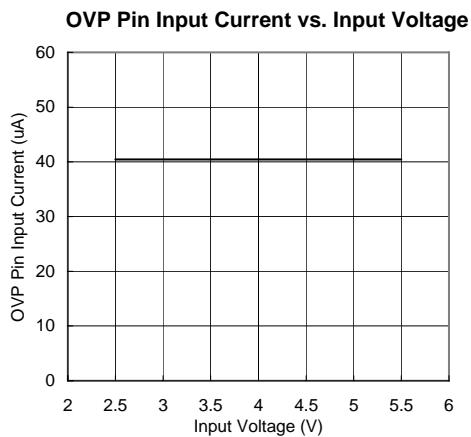
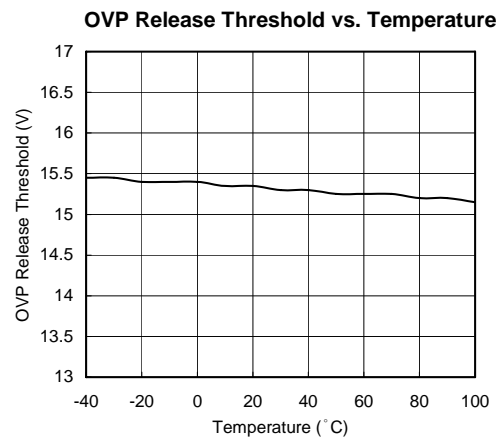
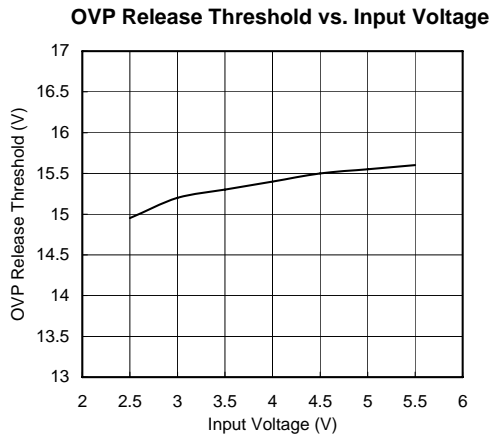
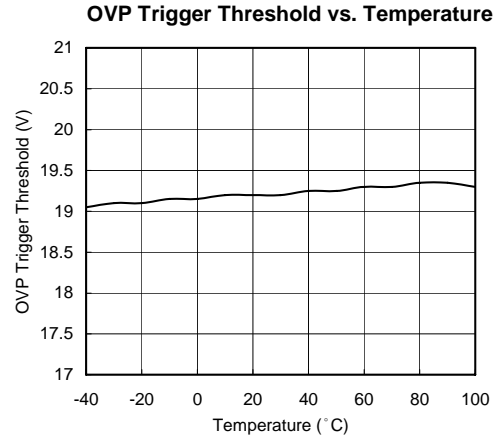
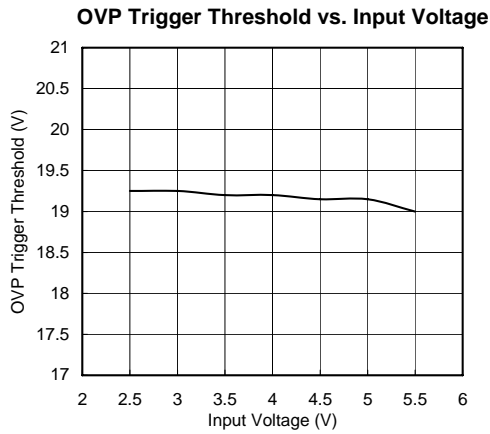

Recommended Minimum Footprint

SOT-23-6

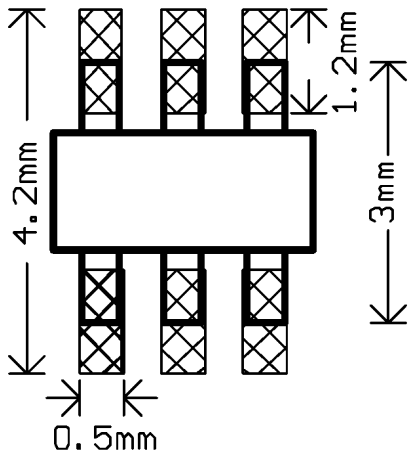

Block Diagram

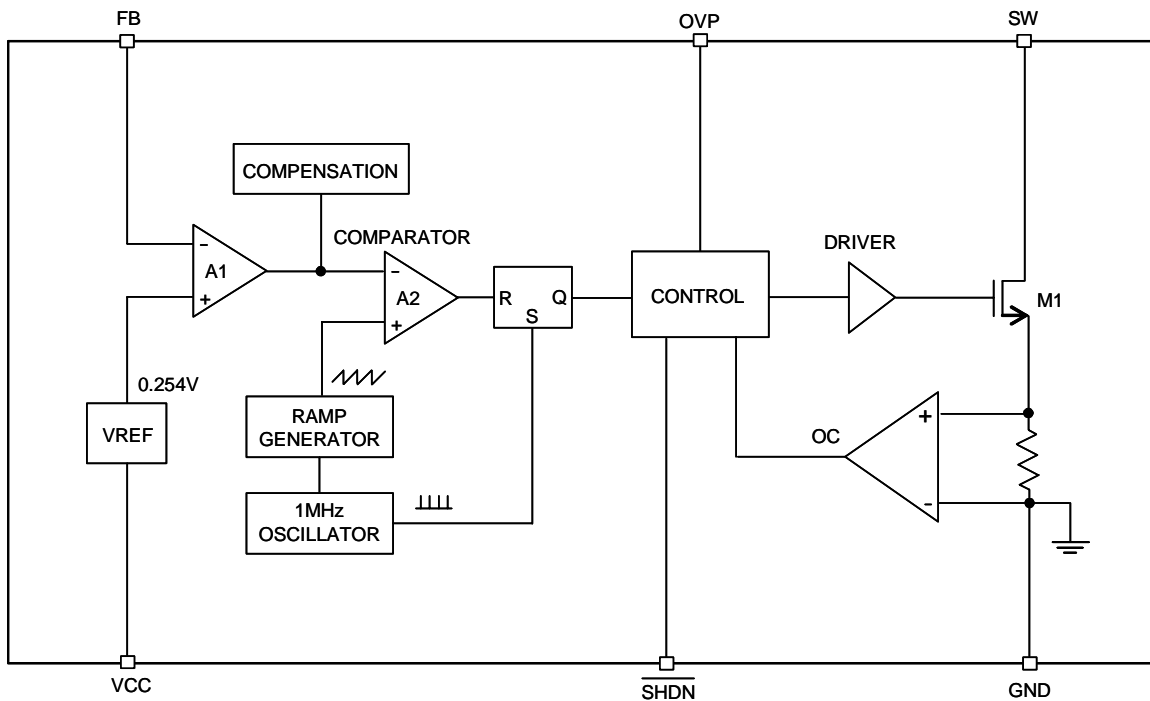

Pin Description

PIN	NAME	FUNCTION
1	SW	Switch Pin. The drain of the internal NMOS power switch. Connect this pin to inductor.
2	GND	Ground Pin.
3	FB	Feedback Pin. Connect current setting resistor R_s from this pin to ground. The LED current is set as $0.254V / R_s$.
4	$\overline{\text{SHDN}}$	Active Low Shutdown Pin.
5	OVP	Over Voltage Protection Sense Pin.
6	VCC	Input Supply Pin. Bypass this pin with a capacitor as close to the device as possible.

Function Description

Normal Operation

The G5121 uses a constant frequency control scheme to provide excellent line and load regulation. Operation can be best understood by referring to the block diagram. At the start of each oscillator cycle, the SR latch is set, which turns on the power switch M1. An artificial ramp is generated to the positive terminal of the PWM comparator A2. When this voltage exceeds the level at the negative input of A2, the SR latch is reset turning off the power switch. The level at the negative input of A2 is set by the error amplifier A1, and is simply an amplified version of the difference between the feedback voltage and the reference voltage of 0.254V. In this manner, the error amplifier sets the correct peak current level to keep the output in regulation. If the error amplifier's output increases, more current is delivered to the output, if it decreases, less current is delivered.

Over Voltage Protection

Over voltage protection function is designed to prevent the damage of internal NMOS switch in case the increased impedance of the LED load (include the LED opened). Once the device detects over voltage (typical 19.5V) at the output, the internal NMOS switch is kept off until the output voltage drops below 15V.

Application Information

Inductor Selection

A 4.7 μ F inductor is recommended for G5121 applications. Small size and high efficiency are the major concerns for most G5121 applications. Inductor with low core losses and small DCR (cooper wire resistance) at 1MHz are good choice for G5121 applications.

Since the G5121 is designed to operate in discontinuous mode, the inductor current reaches zero during discharge phase. After the inductor current reaches zero, the switch pin exhibits ringing due to the LC tank circuit formed by the inductor in combination with switch and diode capacitance. This ringing is not harmful; far less spectral energy is contained in the ringing than in the switch transitions. The ringing can be damped by application of a 300 Ω resistor across the inductor, although this will degrade efficiency.

Capacitor Selection

The small size of ceramic capacitors makes them suitable for G5121 applications. X5R and X7R types are recommended because they retain their capacitance over wider voltage and temperature ranges than other types such as Y5V or Z5U. A minimum 1 μ F capacitor for output is required for most applications. Larger input/output capacitor minimizes input/output ripple.

Diode Selection

Schottky diodes, with their low forward voltage drop and fast reverse recovery, are the ideal choices for G5121 applications. The forward voltage drop of a Schottky diode represents the conduction losses in the diode, while the diode capacitance (C_T or C_D) represents the switching losses. For diode selection, both forward voltage drop and diode capacitance need to be considered. Schottky diodes with higher current ratings usually have lower forward voltage drop and larger diode capacitance, which can cause significant switching losses at the 1MHz switching frequency of the G5121. A Schottky diode rated at 500mA is sufficient for most G5121 applications.

Package Information

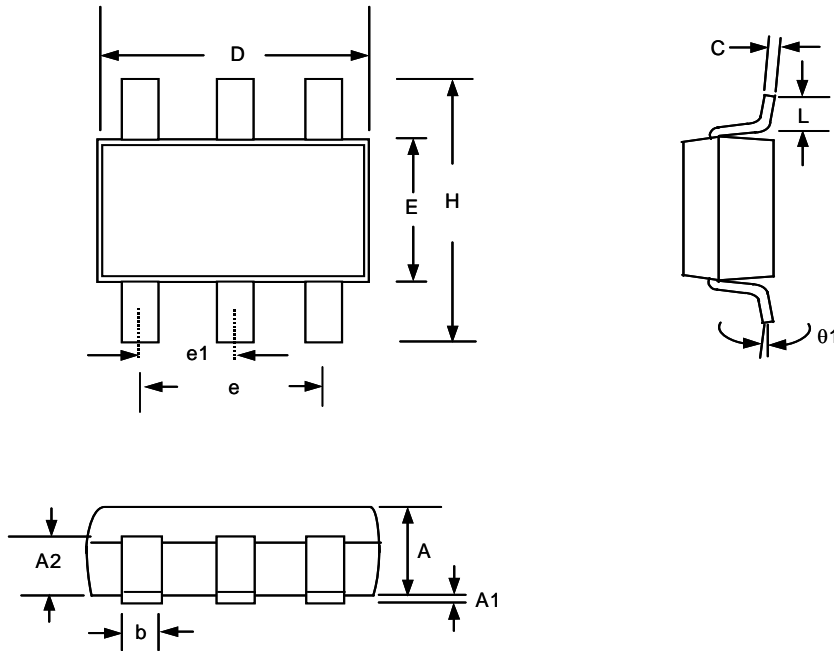

Note:

1. Package body sizes exclude mold flash protrusions or gate burrs
2. Tolerance ± 0.1000 mm (4mil) unless otherwise specified
3. Coplanarity: 0.1000mm
4. Dimension L is measured in gage plane

SYMBOL	DIMENSION IN MM			DIMENSION IN INCH		
	MIN.	NOM.	MAX.	MIN.	NOM.	MAX.
A	1.00	1.10	1.30	0.039	0.043	0.051
A1	0.00	-----	0.10	0.000	-----	0.004
A2	0.70	0.80	0.90	0.028	0.031	0.035
b	0.35	0.40	0.50	0.014	0.016	0.020
C	0.10	0.15	0.25	0.004	0.006	0.010
D	2.70	2.90	3.10	0.106	0.114	0.122
E	1.40	1.60	1.80	0.055	0.063	0.071
e	-----	1.90(TYP)	-----	-----	0.075(TYP)	-----
H	2.60	2.80	3.00	0.102	0.110	0.118
L	0.37	-----	-----	0.015	-----	-----
$\theta 1$	1°	5°	9°	1°	5°	9°

Taping Specification

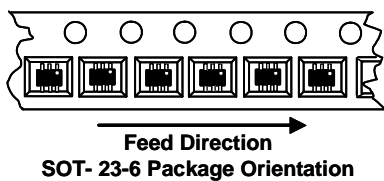

PACKAGE	Q'TY/REEL
SOT-23-6	3,000 ea

GMT Inc. does not assume any responsibility for use of any circuitry described, no circuit patent licenses are implied and GMT Inc. reserves the right at any time without notice to change said circuitry and specifications.