



CODING KEYS

APPLICATION

For those IEEE 1101.10 applications with keying requirements, but do not have front panels. IEEE 1101.10 specifications provides a method for keying slots using programming keys inserted into the front panel assembly and card guide.

Conduction Cooled Modules used in military and ruggedized systems do not use this front panel system. VITA 1.6 standard provides a method of keying for these types of systems.

FEATURES

- Complies with ANSI VITA 1.6 Standard
- Gold or Clear Chem Film aluminum bracket
- 6 configurations per coding bracket set
- 36 configurations in a 6U conduction cooled application
- Up to 1296 Keying combinations in a 6U non-conduction cooled application
- Complimentary mounting hardware included

MATERIALS AND FINISH

CODE KEY BRACKETS

Material:

Aluminum Alloy 6061-T6 QQA-200/8

Finish:

Mil-C Class 1A, Type 1, Gold or

Mil-DTL-5541 Class 3, Type II, Clear

CODE KEY PINS

Material:

Austenitic Stainless Steel

Finish:

None

WEIGHT

100 pcs. = 0.32 lbs.

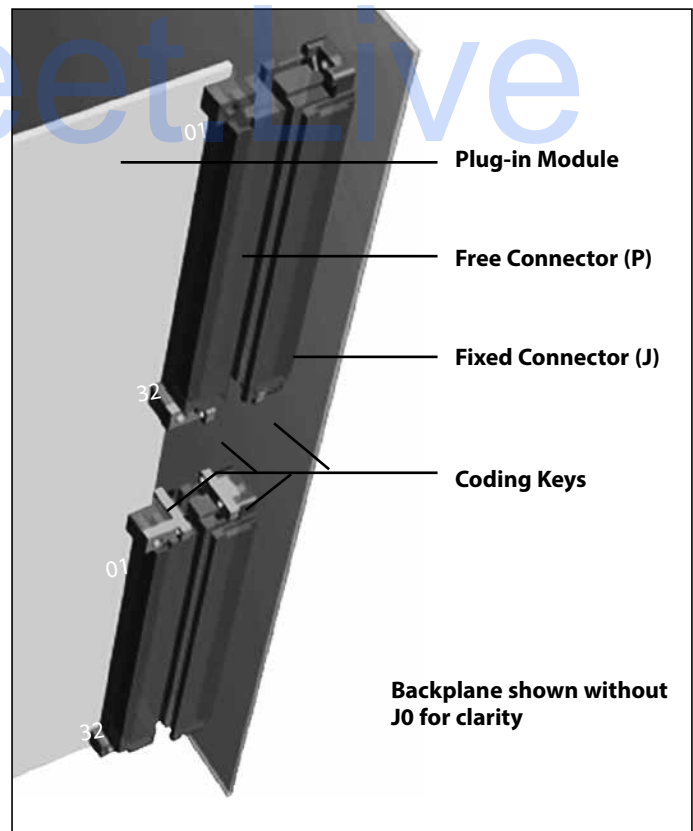

VITA 1.6 CONDUCTION COOLED KEYING

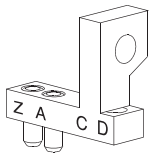

CD key pair

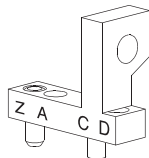

AD key pair

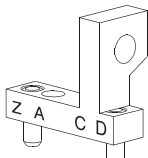

AC key pair

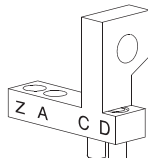

ZA key pair

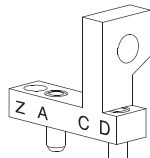

ZC key pair

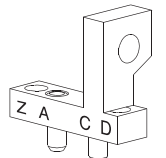

ZD key pair

The drawings above are representative of the J32 and P32 configurations. J01 and P01 are mirror images.

Samples of coding key usage

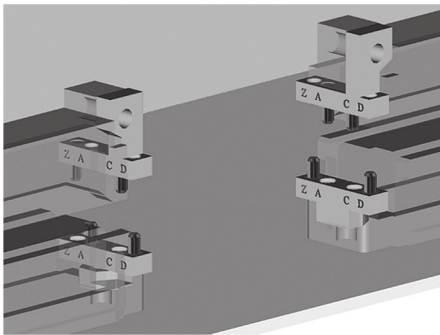

CCKP01-AD
mates with
CCKJ01-AD

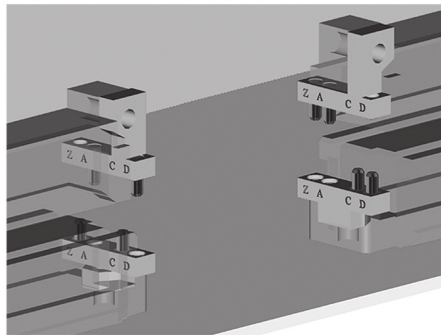

CCKP32-ZD
mates with
CCKJ32-ZD

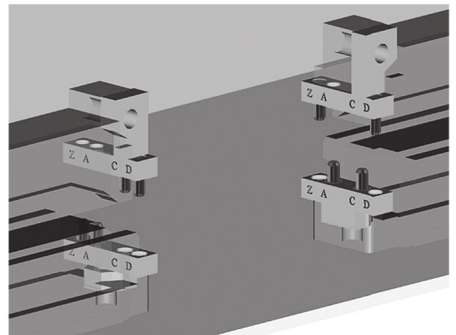

CCKP01-ZA
mates with
CCKJ01-ZA

CCKP01-ZC
mates with
CCKJ01-ZC

CCKP32-CD
mates with
CCKJ32-CD

CCKP32-AC
mates with
CCKJ32-AC

Part Number Code Conduction Cooled Keying

CCK	X	X	-	X	-	X	-	X
Board or Backplane								
Free Connector:		P						
Fixed Connector:		J						
Connector End								
01						01		
32						32		
Keying Configuration								
ZA							ZA	
ZC							ZC	
ZD							ZD	
AC							AC	
AD							AD	
CD							CD	
Thread Type								
Metric 2.5mm x .45 thread:							[blank]	
Imperial 2-56 thread:								1
Imperial 2-56 locking helicoil:								2
Metric 2.5mm x .45 locking helicoil:								3
Finish Type								
Chem Film Gold								[blank]
Chem Film Clear								CC

Also available in Kit Form (see contents example below)

CCK-KIT	-X	-X
Keying Configuration		
ZA		ZA
ZC		ZC
ZD		ZD
AC		AC
AD		AD
CD		CD
Thread Type		
Metric 2.5mm x .45 thread:		[Blank]
Imperial 2-56 thread:		-1
Imperial 2-56 locking helicoil:		-2
Metric 2.5mm x .45 locking helicoil:		-3
Example of Kit Contents:		
CCK-KIT-ZA		
Qty	Item	
1	CCKP01-ZA	
1	CCKJ01-ZA	
1	CCKP32-ZA	
1	CCKJ32-ZA	
4	Complimentary Mounting Screws	
4	Washers	



SCHROFF

nVent may modify standard parts without prior notice to or approval from customers. These modifications may change product appearance, but will not have a detrimental effect on form, fit or function. ©2018 nVent. All nVent marks and logos are owned or licensed by nVent Services GmbH or its affiliates. All other trademarks are the property of their respective owners. nVent reserves the right to change specifications without notice.