



DC COMPONENTS CO., LTD.

RECTIFIER SPECIALISTS

**P6KE6.8
THRU
P6KE440CA**

TECHNICAL SPECIFICATIONS OF TRANSIENT VOLTAGE SUPPRESSOR

VOLTAGE RANGE - 6.8 to 440 Volts

PEAK PULSE POWER - 600 Watts

FEATURES

- * Glass passivated junction
- * 600 Watts Peak Pulse Power capability on 10/1000 μ s waveform
- * Excellent clamping capability
- * Low zener impedance
- * Fast response time

MECHANICAL DATA

- * Case: Molded plastic
- * Epoxy: UL 94V-0 rate flame retardant
- * Lead: MIL-STD-202E, Method 208 guaranteed
- * Polarity: Color band denotes positive end (cathode) except bidirectional types
- * Mounting position: Any
- * Weight: 0.4 gram

MAXIMUM RATINGS AND ELECTRICAL CHARACTERISTICS

Ratings at 25 °C ambient temperature unless otherwise specified.
Single phase, half wave, 60 Hz, resistive or inductive load,
For capacitive load, derate current by 20%.

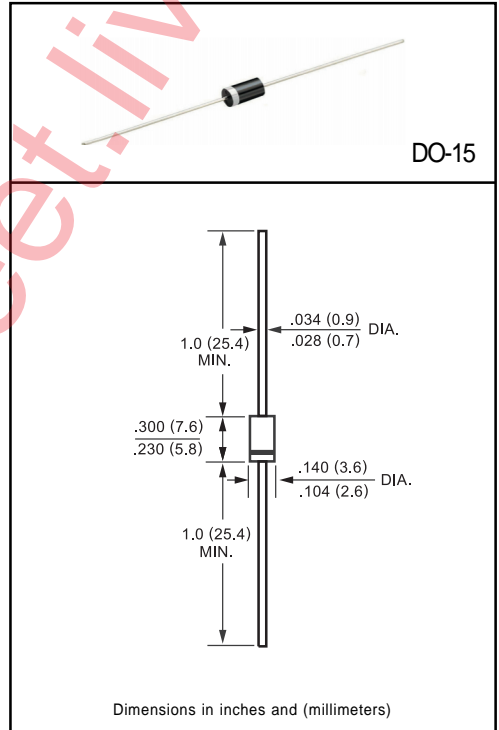

DEVICES FOR BIPOLAR APPLICATIONS

For Bidirectional use C or CA suffix (e.g. P6KE6.8C, P6KE440CA)

Electrical characteristics apply in both directions

	SYMBOL	VALUE	UNITS
Peak Pulse Power Dissipation on 10/1000 μ s waveform (Note1, FIG.1)	PPPM	Minimum 600	Watts
Steady State Power Dissipation at $T_L = 75^\circ\text{C}$ Lead Lengths .375" (9.5 mm) (Note 2)	PM (AV)	5.0	Watts
Peak Forward Surge Current, 8.3ms single half sine-wave superimposed on rated load(JEDEC Method) (Note 3)	IFSM	100	Amps
Maximum Instantaneous Forward Voltage at 50A for Unidirectional Only	V _F	3.5/6.5	Volts
Operating and Storage Temperature Range	T _J , T _{STG}	-65 to + 175	°C

- NOTES : 1. Non-repetitive current pulse, per Fig.3 and derated above $T_A = 25^\circ\text{C}$ per Fig.2.
2. Mounted on Copper Leaf area of 1.6 X 1.6"(40X40 mm) per Fig. 5
3. 8.3ms single half sine-wave or equivalent square wave, duty cycle = 4 pulses per minute maximum.
4. V_F = 3.5V max. for devices of V(BR) \leq 200V and V_F = 6.5V for devices of V(BR) > 200V.

RATING AND CHARACTERISTIC CURVES (P6KE6.8 THRU P6KE440CA)

FIG. 1 - PEAK PULSE POWER RATING CURVE

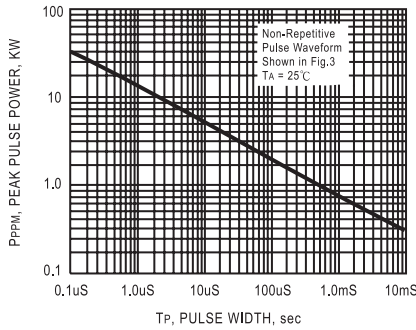

FIG. 2 - PULSE DERATING CURVE

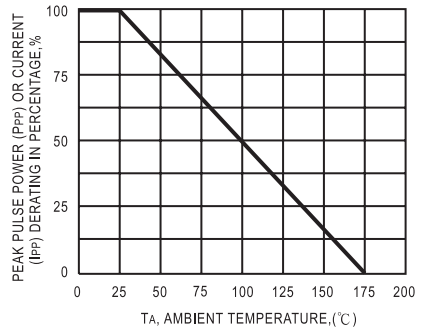

FIG. 3 - PULSE WAVEFORM

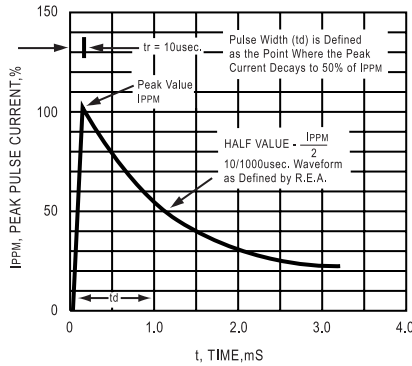

FIG. 4 - TYPICAL JUNCTION CAPACITANCE

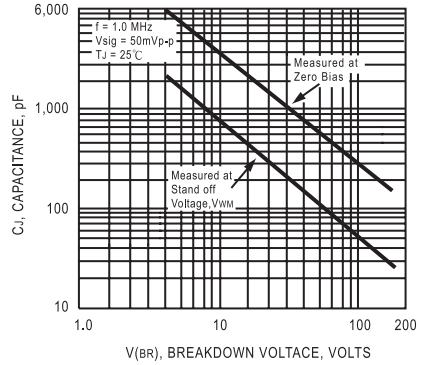

FIG. 5 - STEADY STATE POWER DERATING CURVE

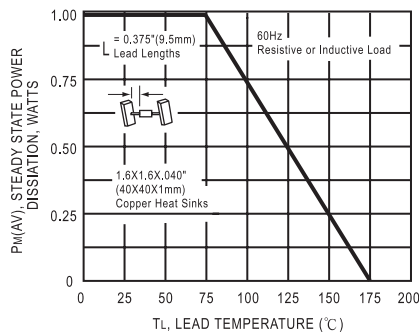

FIG. 6 - MAXIMUM NON-REPETITIVE FORWARD SURGE CURRENT UNIDIRECTIONAL

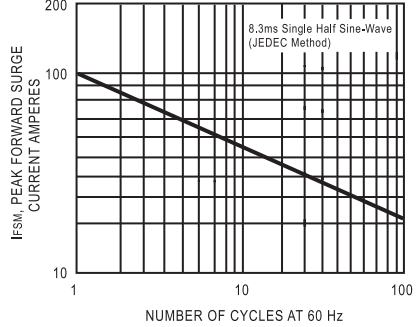
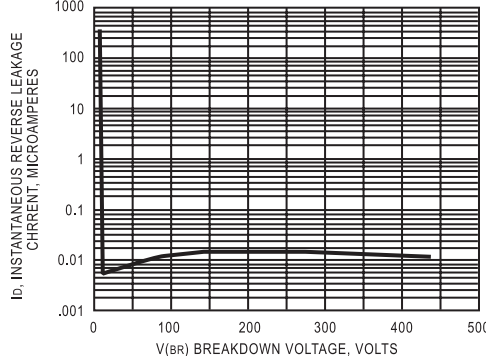

FIG. 7 - TYPICAL REVERSE LEAKAGE CHARACTERISTICS



DC COMPONENTS CO., LTD.

P6KE (600W) SERIES TRANSIENT VOLTAGE SUPPRESSORS

TYPE	Breakdown Voltage			Reverse Stand off Voltage V_{WM} (Volts)	Maximum Reverse Leakage at V_{WM} I_D (μ A)	Maximum Peak Pulse Current I_{PPM} (Amps)	Maximum Clamping Voltage at I_{PPM} V_C (Volts)
	V_{BR} (Volts)		@ I_T (mA)				
	MIN.	MAX.					
P6KE6.8	6.12	7.48	10	5.50	1000	58	10.8
P6KE6.8A	6.45	7.14	10	5.80	1000	60	10.5
P6KE7.5	6.75	8.25	10	6.05	500	53	11.7
P6KE7.5A	7.13	7.88	10	6.40	500	55	11.3
P6KE8.2	7.38	9.02	10	6.63	200	50	12.5
P6KE8.2A	7.79	8.61	10	7.02	200	52	12.1
P6KE9.1	8.19	10.0	1.0	7.37	50	45	13.8
P6KE9.1A	8.69	9.55	1.0	7.78	50	47	13.4
P6KE10	9.00	11.0	1.0	8.10	10	42	15.0
P6KE10A	9.50	10.5	1.0	8.55	10	43	14.5
P6KE11	9.90	12.1	1.0	8.92	5.0	38	16.2
P6KE11A	10.5	11.6	1.0	9.40	5.0	40	15.6
P6KE12	10.8	13.2	1.0	9.72	5.0	36	17.3
P6KE12A	11.4	12.6	1.0	10.2	5.0	37	16.7
P6KE13	11.7	14.3	1.0	10.5	5.0	33	19.0
P6KE13A	12.4	13.7	1.0	11.1	5.0	34	18.2
P6KE15	13.5	16.5	1.0	12.1	5.0	28	22.0
P6KE15A	14.3	15.8	1.0	12.8	5.0	29	21.2
P6KE16	14.4	17.6	1.0	12.9	5.0	26	23.5
P6KE16A	15.2	16.8	1.0	13.6	5.0	28	22.5
P6KE18	16.2	19.8	1.0	14.5	5.0	23	26.5
P6KE18A	17.1	18.9	1.0	15.3	5.0	25	25.2
P6KE20	18.0	22.0	1.0	16.2	5.0	21	29.1
P6KE20A	19.0	21.0	1.0	17.1	5.0	22	27.7
P6KE22	19.8	24.2	1.0	17.8	5.0	19	31.9
P6KE22A	20.9	23.1	1.0	18.8	5.0	20	30.6
P6KE24	21.6	26.4	1.0	19.4	5.0	18	34.7
P6KE24A	22.8	25.2	1.0	20.5	5.0	19	33.2
P6KE27	24.3	29.7	1.0	21.8	5.0	16	39.1
P6KE27A	25.7	28.4	1.0	23.1	5.0	16.8	37.5
P6KE30	27.0	33.0	1.0	24.3	5.0	14	43.5
P6KE30A	28.5	31.5	1.0	25.6	5.0	15	41.4
P6KE33	29.7	36.3	1.0	26.8	5.0	13	47.7
P6KE33A	31.4	34.7	1.0	28.2	5.0	13.8	45.7
P6KE36	32.4	39.6	1.0	29.1	5.0	12	52.0
P6KE36A	34.2	37.8	1.0	30.8	5.0	12.6	49.9
P6KE39	35.1	42.9	1.0	31.6	5.0	11.1	56.4
P6KE39A	37.1	41.0	1.0	33.3	5.0	11.6	53.9
P6KE43	38.7	47.3	1.0	34.8	5.0	10.0	61.9
P6KE43A	40.9	45.2	1.0	36.8	5.0	10.6	59.3
P6KE47	42.3	51.7	1.0	38.1	5.0	9.2	67.8
P6KE47A	44.7	49.4	1.0	40.2	5.0	9.7	64.8
P6KE51	45.9	56.1	1.0	41.3	5.0	8.5	73.5
P6KE51A	48.5	53.6	1.0	43.6	5.0	8.9	70.1
P6KE56	50.4	61.6	1.0	45.4	5.0	7.8	80.5
P6KE56A	53.2	58.8	1.0	47.8	5.0	8.1	77.0



DC COMPONENTS CO., LTD.

P6KE (600W) SERIES TRANSIENT VOLTAGE SUPPRESSORS

TYPE	Breakdown Voltage			Reverse Stand off Voltage VWM (Volts)	Maximum Reverse Leakage at VWM Id(uA)	Maximum Peak Pulse Current IPPM (Amps)	Maximum Clamping Voltage at IPPM Vc (Volts)
	VBR (Volts)		@IT (mA)				
	MIN.	MAX.					
P6KE62	55.8	68.2	1.0	50.2	5.0	7.0	89.0
P6KE62A	58.9	65.1	1.0	53.0	5.0	7.4	85.0
P6KE68	61.2	74.8	1.0	55.1	5.0	6.4	98.0
P6KE68A	64.6	71.4	1.0	58.1	5.0	6.8	92.0
P6KE75	67.5	82.5	1.0	60.7	5.0	5.8	108
P6KE75A	71.3	78.8	1.0	64.1	5.0	6.1	103
P6KE82	73.8	90.2	1.0	66.4	5.0	5.3	118
P6KE82A	77.9	86.1	1.0	70.1	5.0	5.5	113
P6KE91	81.9	100	1.0	73.7	5.0	4.8	131
P6KE91A	86.5	95.5	1.0	77.8	5.0	5.0	125
P6KE100	90.0	110	1.0	81.0	5.0	4.3	144
P6KE100A	95.0	105	1.0	85.5	5.0	4.5	137
P6KE110	99.0	121	1.0	89.2	5.0	3.9	158
P6KE110A	105	116	1.0	94.0	5.0	4.1	152
P6KE120	108	132	1.0	97.2	5.0	3.6	173
P6KE120A	114	126	1.0	102	5.0	3.8	165
P6KE130	117	143	1.0	105	5.0	3.3	187
P6KE130A	124	137	1.0	111	5.0	3.5	179
P6KE150	135	165	1.0	121	5.0	2.9	215
P6KE150A	143	158	1.0	128	5.0	3.0	207
P6KE160	144	176	1.0	130	5.0	2.7	230
P6KE160A	152	168	1.0	136	5.0	2.8	219
P6KE170	153	187	1.0	138	5.0	2.5	244
P6KE170A	162	179	1.0	145	5.0	2.6	234
P6KE180	162	198	1.0	146	5.0	2.4	258
P6KE180A	171	189	1.0	154	5.0	2.5	246
P6KE200	180	220	1.0	162	5.0	2.2	287
P6KE200A	190	210	1.0	171	5.0	2.1	274
P6KE220	198	242	1.0	175	5.0	1.8	344
P6KE220A	209	231	1.0	185	5.0	1.9	328
P6KE250	225	275	1.0	202	5.0	1.7	360
P6KE250A	237	263	1.0	214	5.0	1.8	344
P6KE300	270	330	1.0	243	5.0	1.4	430
P6KE300A	285	315	1.0	256	5.0	1.5	414
P6KE350	315	385	1.0	284	5.0	1.2	504
P6KE350A	332	368	1.0	300	5.0	1.3	482
P6KE400	360	440	1.0	324	5.0	1.9	574
P6KE400A	380	420	1.0	342	5.0	1.1	548
P6KE440	396	484	1.0	356	5.0	0.95	630
P6KE440A	418	462	1.0	376	5.0	1.00	600

- NOTES : 1.VBR measured after IT applied for 300µs. IT= Square Wave Pulse or equivalent.
 2.For bidirectional use C or CA suffixs for all types (ex. P6KE6.8C, P6KE440CA).
 electrical characteristics apply in both directions.
 3.For bidirectional types having VWM of 10 volts and less, the Id limit is doubled.



DC COMPONENTS CO., LTD.