



TLP521, TLP521-2, TLP521-4



DESCRIPTION

The TLP521, TLP521-2 and TLP521-4 series of optically coupled isolator consist of an infrared light emitting diode and an NPN silicon photo transistor in a space efficient Dual In Line Plastic Package.

FEATURES

- AC Isolation Voltage 5300V_{RMS}
- CTR Selections Available
- Wide Operating Temperature Range -30°C to +100°C
- Lead Free and RoHS Compliant
- UL File E91231 Package Code "EE"
- VDE Approval Certificate No. 40028086

APPLICATIONS

- Computer Terminals
- Industrial System Controllers
- Measuring Instruments
- Signal Transmission between Systems of Different Potentials and Impedances

ORDER INFORMATION

- Add X after PN for VDE Approval
- Add G after PN for 10mm lead spacing
- Add SM after PN for Surface Mount
- Add SMT&R after PN for Surface Mount Tape & Reel (Available for TLP521SM and TLP521-2SM)
- Consult Factory for Tape and Reel version of TLP521-4SM

TLP521

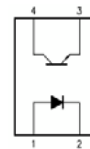

TLP521-2

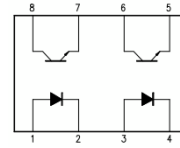

TLP521-4

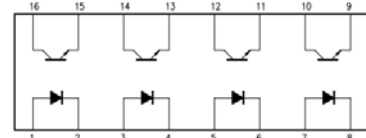

ABSOLUTE MAXIMUM RATINGS (T_A = 25°C)

Stresses exceeding the absolute maximum ratings can cause permanent damage to the device. Exposure to absolute maximum ratings for long periods of time can adversely affect reliability.

Input

Forward Current	50mA
Reverse Voltage	6V
Power dissipation	70mW

Output

Collector to Emitter Voltage BV _{CEO}	55V
Emitter to Collector Voltage BV _{ECO}	6V
Collector Current	50mA
Power Dissipation	150mW

Total Package

Isolation Voltage	5300V _{RMS}
Total Power Dissipation	200mW
Operating Temperature	-30 to 100 °C
Storage Temperature	-55 to 125 °C
Lead Soldering Temperature (10s)	260°C

ISOCOM COMPONENTS 2004 LTD

Unit 25B, Park View Road West, Park View Industrial Estate
Hartlepool, Cleveland, TS25 1PE, United Kingdom
Tel : +44 (0)1429 863 609 Fax : +44 (0)1429 863 581
e-mail : sales@isocom.co.uk
<http://www.isocom.com>

ISOCOM COMPONENTS ASIA LTD

Hong Kong Office
Block A, 8/F, Wah Hing Industrial Mansion
36 Tai Yau Street, San Po Kong, Kowloon, Hong Kong
Tel : +852 2995 9217 Fax : +852 8161 6292
e-mail : sales@isocom.com.hk



TLP521, TLP521-2, TLP521-4

ELECTRICAL CHARACTERISTICS (Ambient Temperature = 25°C unless otherwise specified)

INPUT

Parameter	Symbol	Test Condition	Min	Typ.	Max	Unit
Forward Voltage	V_F	$I_F = 10\text{mA}$	1.0	1.15	1.3	V
Reverse Voltage	V_R	$I_R = 10\mu\text{A}$	6.0			V
Reverse Leakage	I_R	$V_R = 4\text{V}$			10	μA
Terminal Capacitance	C_t	$V = 0\text{V}, f = 1\text{KHz}$		30	250	pF

OUTPUT

Parameter	Symbol	Test Condition	Min	Typ.	Max	Unit
Collector—Emitter breakdown Voltage	BV_{CEO}	$I_C = 0.5\text{mA}, I_F = 0\text{mA}$	55			V
Emitter—Collector breakdown Voltage	BV_{ECO}	$I_E = 100\mu\text{A}, I_F = 0\text{mA}$	6			V
Collector-Emitter Dark Current	I_{CEO}	$V_{CE} = 20\text{V}, I_F = 0\text{mA}$			100	nA



TLP521, TLP521-2, TLP521-4

ELECTRICAL CHARACTERISTICS (Ambient Temperature = 25°C unless otherwise specified)

COUPLED

Parameter	Symbol	Test Condition	Min	Typ.	Max	Unit
Current Transfer Ratio	CTR	$I_F = 5\text{mA}$, $V_{CE} = 5\text{V}$	50		600	%
		Optional CTR Grades				
		GR	100		300	
		BL	200		600	
		GB	100		600	
		GB ($I_F = 1\text{mA}$, $V_{CE} = 0.4\text{V}$)	30			
Collector—Emitter Saturation Voltage	$V_{CE(sat)}$	$I_F = 8\text{mA}$, $I_C = 2.4\text{mA}$ GB ($I_F = 1\text{mA}$, $I_C = 0.2\text{mA}$)			0.4 0.4	V
Output Rise Time	t_r	$V_{CE} = 2\text{V}$, $I_C = 2\text{mA}$, $R_L = 100\Omega$		4		μs
Output Fall Time	t_f			3		
Turn-on Time	t_{on}			3		
Turn-off Time	t_{off}			3		
Turn-on Time	t_{ON}	$V_{CC} = 5\text{V}$, $I_F = 16\text{mA}$, $R_L = 1.9\text{k}\Omega$		2		μs
Turn-off Time	t_{OFF}			25		

ISOLATION

Parameter	Symbol	Test Condition	Min	Typ.	Max	Unit
Input to Output Isolation Voltage	V_{ISO}	AC 1 minute, RH = 40 to 60% Note 1	5300			V_{RMS}
Input to Output Isolation Resistance	R_{ISO}	$V_{IO} = 500\text{V}$ Note 1	5×10^{10}			Ω

Note 1 : Measure with input leads shorted together and output leads shorted together.



TLP521, TLP521-2, TLP521-4

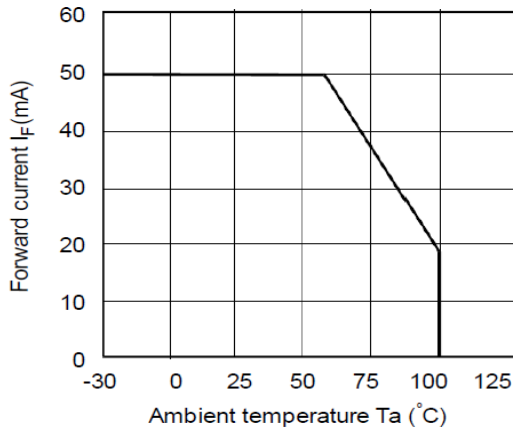

Fig 1 Forward Current vs T_A

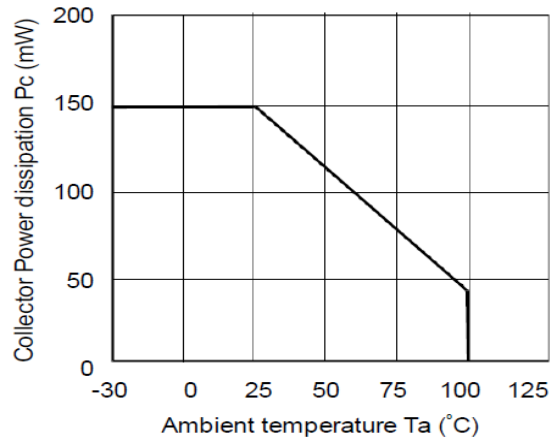

Fig 2 Collector Power Dissipation vs T_A

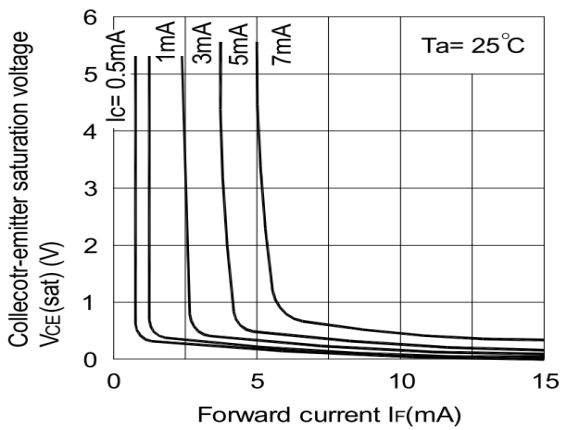

Fig 3 Collector-emitter Saturation Voltage vs Forward Current

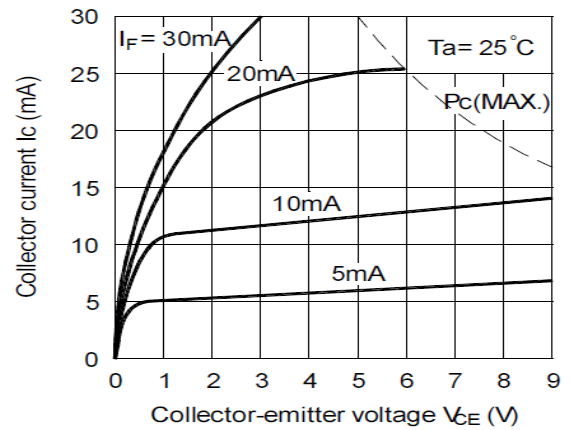

Fig 4 Collector Current vs Collector-emitter Voltage

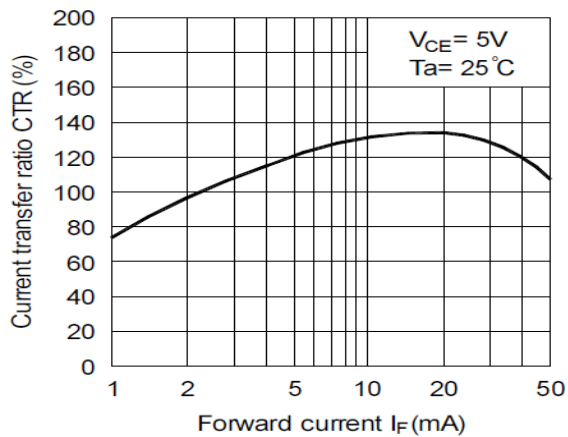

Fig 5 Current Transfer Ratio vs Forward Current

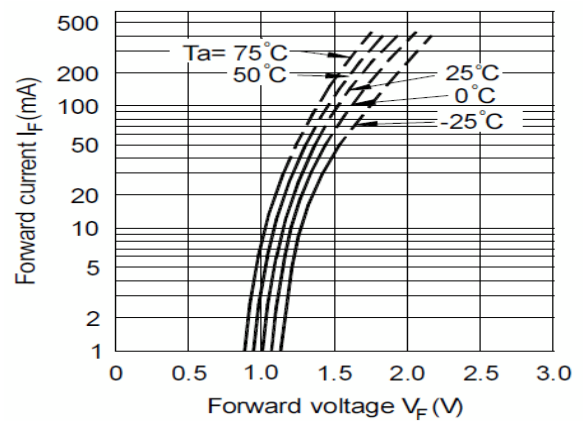

Fig 6 Forward Current vs Forward Voltage



TLP521, TLP521-2, TLP521-4

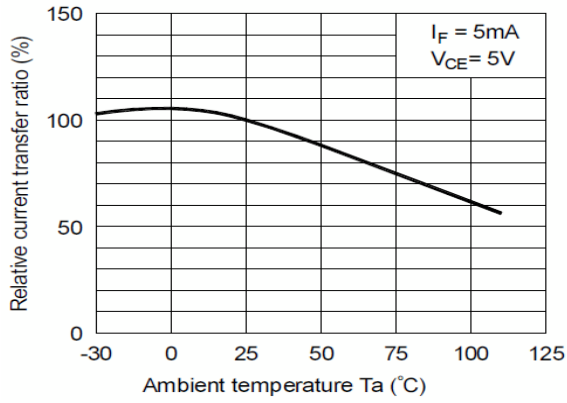

Fig 7 Relative CTR vs T_A

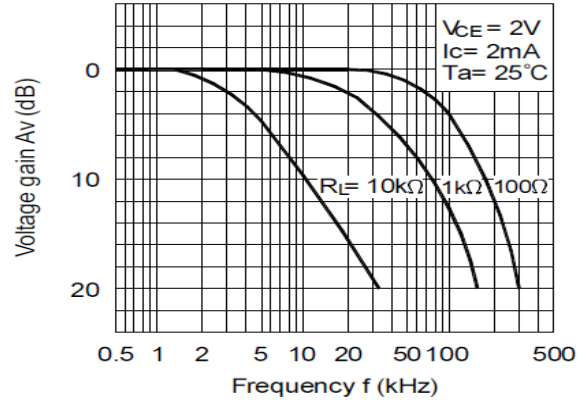

Fig 8 Frequency Response

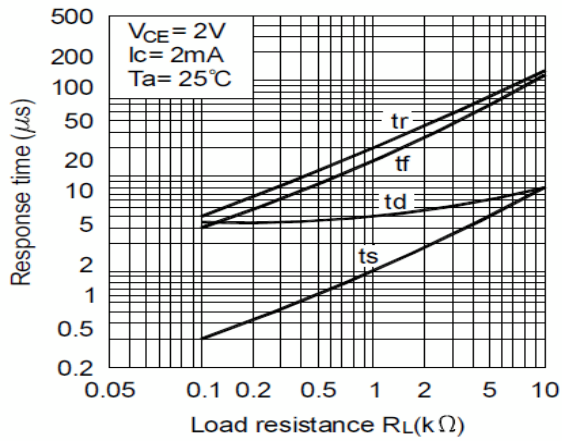
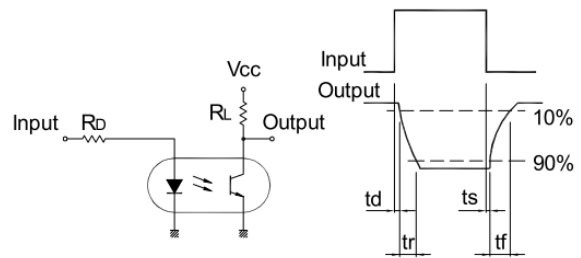

Fig 9 Response Time vs Load Resistance



Response Time Test Circuit



TLP521, TLP521-2, TLP521-4

ORDER INFORMATION

TLP521 (UL Approval)			
After PN	PN	Description	Packing quantity
None	TLP521, TLP521GR, TLP521BL, TLP521GB	Standard DIP4	100 pcs per tube
G	TLP521G, TLP521GRG, TLP521BLG, TLP521GBG	10mm Lead Spacing	100 pcs per tube
SM	TLP521SM, TLP521GRSM, TLP521BLSM, TLP521GBSM	Surface Mount	100 pcs per tube
SMT&R	TLP521SMT&R, TLP521GRSMT&R, TLP521BLSMT&R, TLP521GBSMT&R	Surface Mount Tape & Reel	1000 pcs per reel

TLP521-2 (UL Approval)			
After PN	PN	Description	Packing quantity
None	TLP521-2, TLP521-2GR, TLP521-2BL, TLP521-2GB	Standard DIP8	50 pcs per tube
G	TLP521-2G, TLP521-2GRG, TLP521-2BLG, TLP521-2GBG	10mm Lead Spacing	50 pcs per tube
SM	TLP521-2SM, TLP521-2GRSM, TLP521-2BLSM, TLP521-2GBSM	Surface Mount	50 pcs per tube
SMT&R	TLP521-2SMT&R, TLP521-2GRSMT&R, TLP521-2BLSMT&R, TLP521-2GBSMT&R	Surface Mount Tape & Reel	1000 pcs per reel

TLP521-4 (UL Approval)			
After PN	PN	Description	Packing quantity
None	TLP521-4, TLP521-4GR, TLP521-4BL, TLP521-4GB	Standard DIP16	25 pcs per tube
G	TLP521-4G, TLP521-4GRG, TLP521-4BLG, TLP521-4GBG	10mm Lead Spacing	25 pcs per tube
SM	TLP521-4SM, TLP521-4GRSM, TLP521-4BLSM, TLP521-4GBSM	Surface Mount	25 pcs per tube



TLP521, TLP521-2, TLP521-4

ORDER INFORMATION

TLP521X (UL and VDE Approvals)			
After PN	PN	Description	Packing quantity
None	TLP521X, TLP521XGR, TLP521XBL, TLP521XGB	Standard DIP4	100 pcs per tube
G	TLP521XG, TLP521XGRG, TLP521XBLG, TLP521XGBG	10mm Lead Spacing	100 pcs per tube
SM	TLP521XSM, TLP521XGRSM, TLP521XBLSM, TLP521XGBSM	Surface Mount	100 pcs per tube
SMT&R	TLP521XSMT&R, TLP521XGRSMT&R, TLP521XBLSMT&R, TLP521XGBXSMT&R	Surface Mount Tape & Reel	1000 pcs per reel

TLP521-2X (UL and VDE Approvals)			
After PN	PN	Description	Packing quantity
None	TLP521-2X, TLP521-2XGR, TLP521-2XBL, TLP521-2XGB	Standard DIP8	50 pcs per tube
G	TLP521-2XG, TLP521-2XGRG, TLP521-2XBLG, TLP521-2XGBG	10mm Lead Spacing	50 pcs per tube
SM	TLP521-2XSM, TLP521-2XGRSM, TLP521-2XBLSM, TLP521-2XGBSM	Surface Mount	50 pcs per tube
SMT&R	TLP521-2XSMT&R, TLP521-2XGRSMT&R, TLP521-2XBLSMT&R, TLP521-2XGBSMT&R	Surface Mount Tape & Reel	1000 pcs per reel

TLP521-4X (UL and VDE Approvals)			
After PN	PN	Description	Packing quantity
None	TLP521-4X, TLP521-4XGR, TLP521-4XBL, TLP521-4XGB	Standard DIP16	25 pcs per tube
G	TLP521-4XG, TLP521-4XGRG, TLP521-4XBLG, TLP521-4XGBG	10mm Lead Spacing	25 pcs per tube
SM	TLP521-4XSM, TLP521-4XGRSM, TLP521-4XBLSM, TLP521-4XGBSM	Surface Mount	25 pcs per tube



TLP521, TLP521-2, TLP521-4

PACKAGE DIMENSIONS in mm (inch)

DIP

TLP521

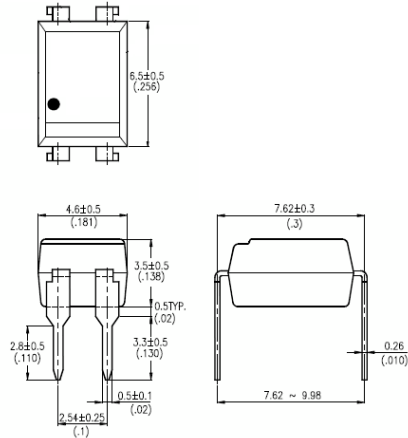

TLP521-2

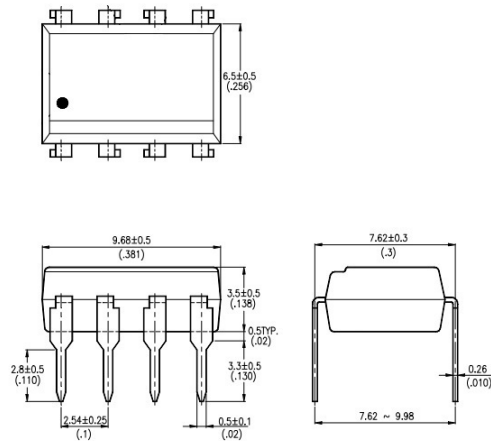

TLP521-4

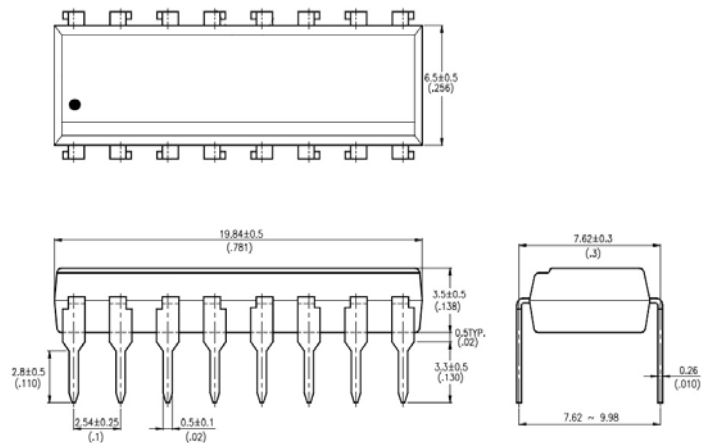



TLP521, TLP521-2, TLP521-4

PACKAGE DIMENSIONS in mm (inch)

G Form

TLP521

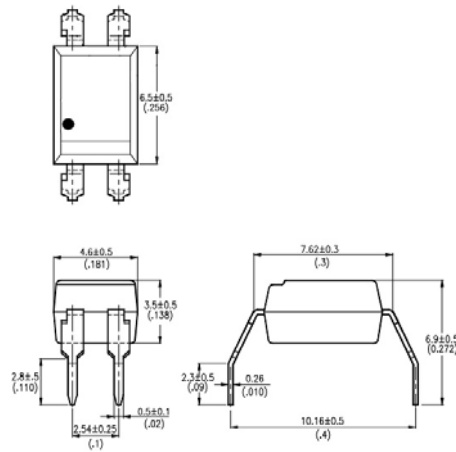

TLP521-2

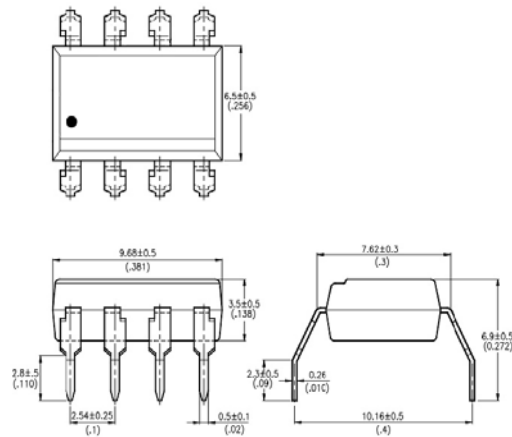

TLP521-4

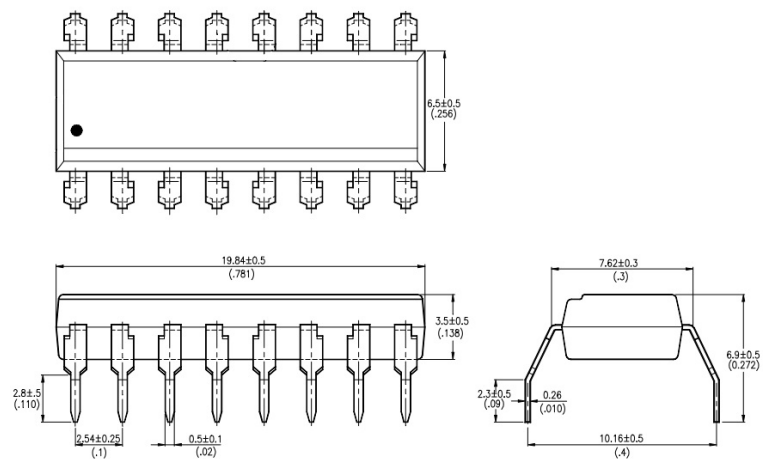



TLP521, TLP521-2, TLP521-4

PACKAGE DIMENSIONS in mm (inch)

SMD

TLP521

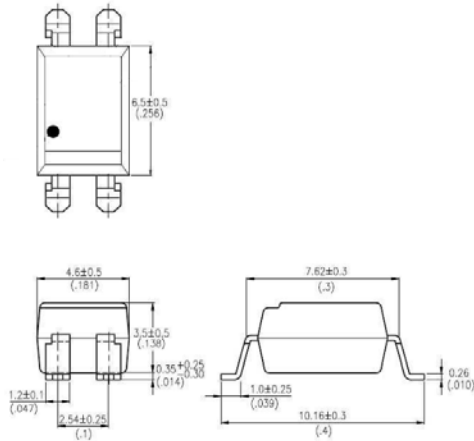

TLP521-2

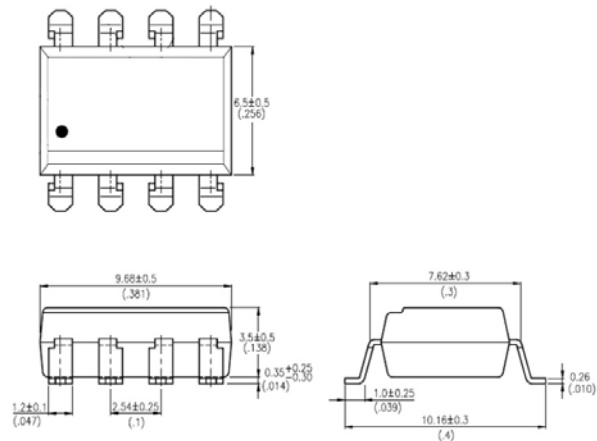

TLP521-4

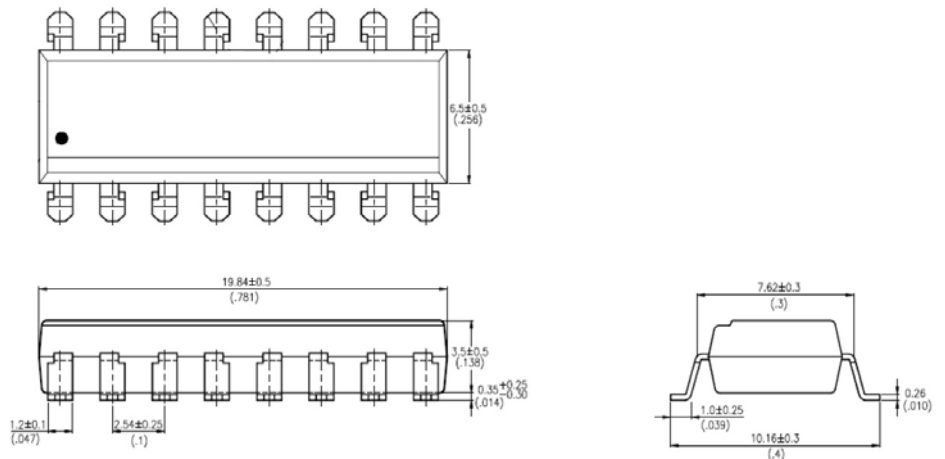



TLP521, TLP521-2, TLP521-4

RECOMMENDED PAD LAYOUT FOR SMD (mm)

TLP521SM

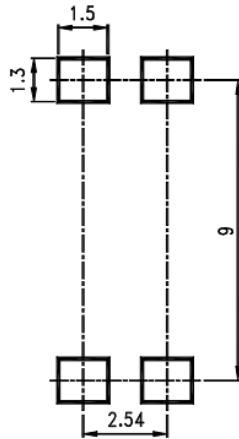

TLP521-2SM

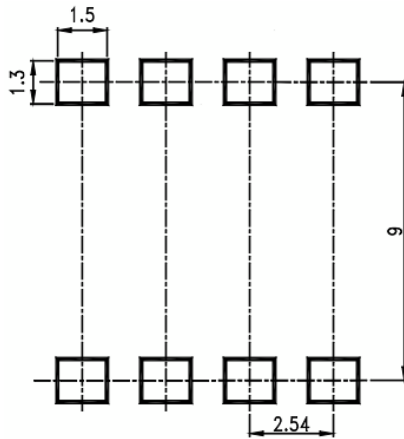

TLP521-4SM

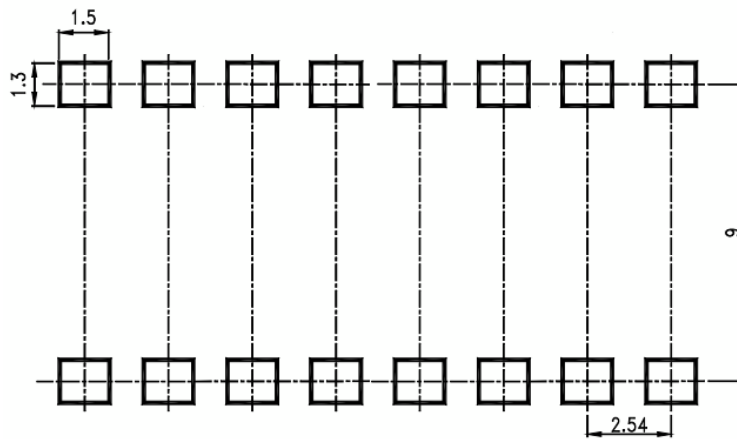



TLP521, TLP521-2, TLP521-4

TAPE AND REEL PACKAGING

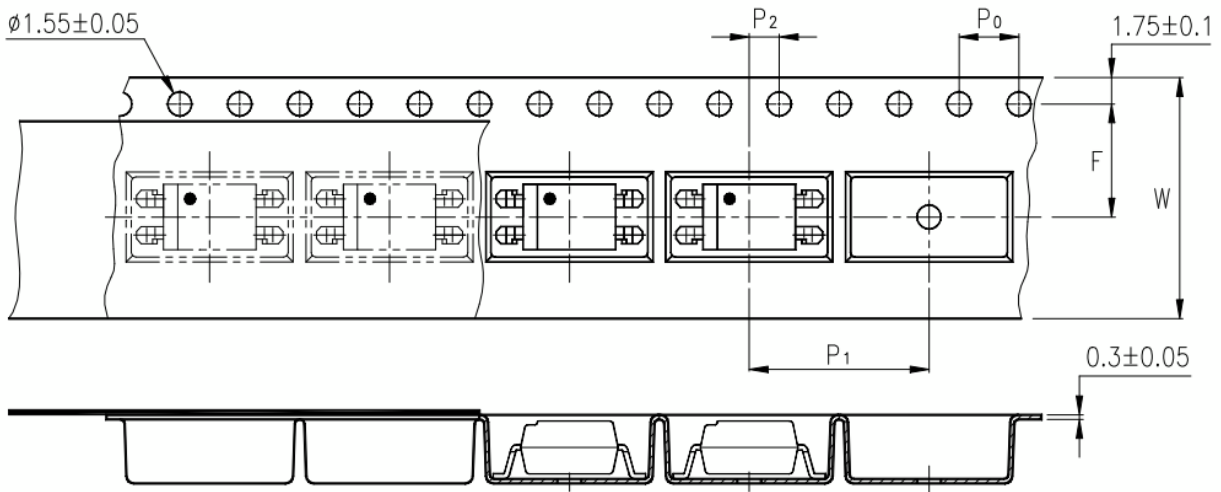

TLP521SMT&R

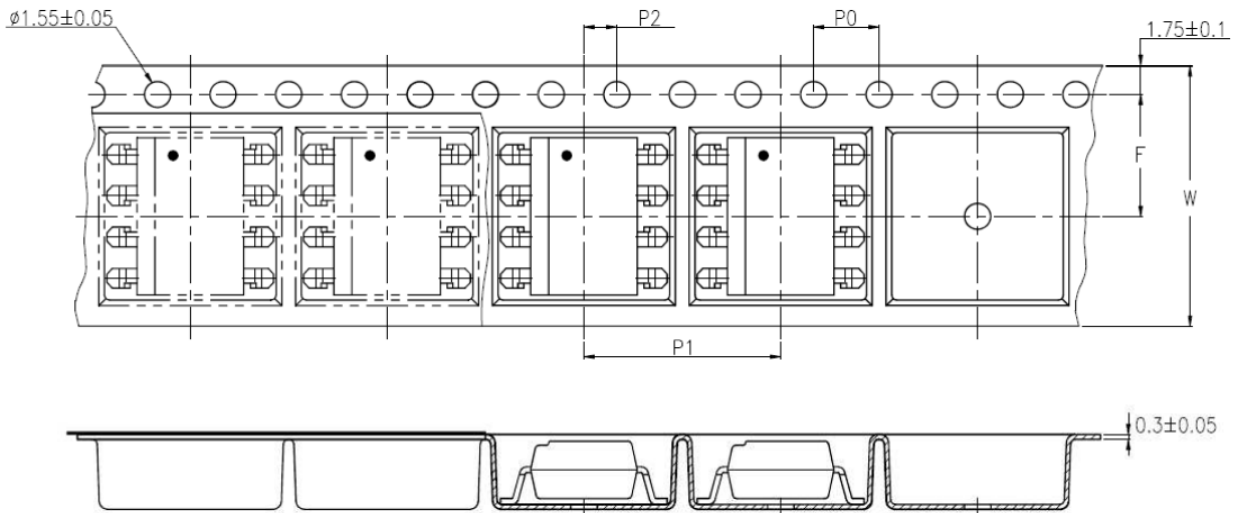

TLP521-2SMT&R

Description	Symbol	Dimensions in mm (inches)
Tape wide	W	16 ± 0.3 (.63)
Pitch of sprocket holes	P_0	4 ± 0.1 (.15)
Distance of compartment	F	7.5 ± 0.1 (.295)
Distance of compartment to compartment	P_1	2 ± 0.1 (.079)
Distance of compartment to compartment	P_2	12 ± 0.1 (.472)



TLP521, TLP521-2, TLP521-4

**IR REFLOW SOLDERING TEMPERATURE PROFILE FOR SMD
(One Time Reflow Soldering is Recommended)**

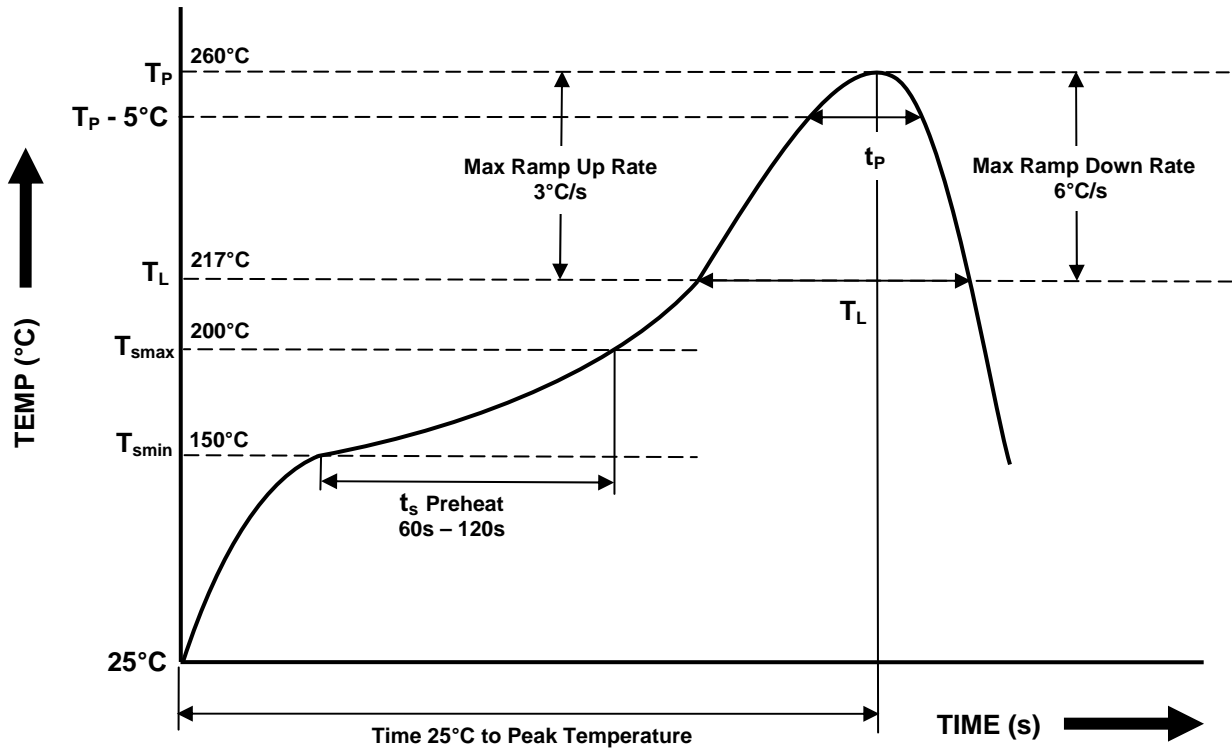

Profile Details	Conditions
Preheat - Min Temperature (T_{SMIN}) - Max Temperature (T_{SMAX}) - Time T_{SMIN} to T_{SMAX} (t_s)	150°C 200°C 60s - 120s
Soldering Zone - Peak Temperature (T_P) - Time at Peak Temperature - Liquidous Temperature (T_L) - Time within 5°C of Actual Peak Temperature ($T_P - 5^\circ C$) - Time maintained above T_L (t_L) - Ramp Up Rate (T_L to T_P) - Ramp Down Rate (T_P to T_L)	260°C 10s max 217°C 30s max 60s - 100s 3°C/s max 6°C/s max
Average Ramp Up Rate (T_{smax} to T_P)	3°C/s max
Time 25°C to Peak Temperature	8 minutes max



ISOCOM
COMPONENTS

TLP521, TLP521-2, TLP521-4

NOTES :

- Isocom is continually improving the quality, reliability, function or design and Isocom reserves the right to make changes without further notices.
- The products shown in this publication are designed for the general use in electronic applications such as office automation equipment, communications devices, audio/visual equipment, electrical application and instrumentation.
- For equipment/application where high reliability or safety is required, such as space applications, nuclear power control equipment, medical equipment, etc., please contact our sales representatives.
- When requiring a device for any "specific" application, please contact our sales for advice.
- The contents described herein are subject to change without prior notice.
- Do not immerse device body in solder paste.



DISCLAIMER

___ ISOCOM is continually working to improve the quality and reliability of its products. Nevertheless, semiconductor devices in general can malfunction or fail due to their inherent electrical sensitivity and vulnerability to physical stress. It is the responsibility of the buyer, when utilizing ISOCOM products, to comply with the standards of safety in making a safe design for the entire system, and to avoid situations in which a malfunction or failure of such ISOCOM products could cause loss of human life, bodily injury or damage to property.

In developing your designs, please ensure that ISOCOM products are used within specified operating ranges as set forth in the most recent ISOCOM products specifications.

___ The ISOCOM products listed in this document are intended for usage in general electronics applications (computer, personal equipment, office equipment, measuring equipment, industrial robotics, domestic appliances, etc.). These ISOCOM products are neither intended nor warranted for usage in equipment that requires extraordinarily high quality and/or reliability or a malfunction or failure of which may cause loss of human life or bodily injury ("Unintended Usage"). Unintended Usage include atomic energy control instruments, airplane or spaceship instruments, transportation Instruments, traffic signal instruments, combustion control instruments, medical Instruments, all types of safety devices, etc.. Unintended Usage of ISOCOM products listed in this document shall be made at the customer's own risk.

___ Gallium arsenide (GaAs) is a substance used in the products described in this document. GaAs dust and fumes are toxic. Do not break, cut or pulverize the product, or use chemicals to dissolve them. When disposing of the products, follow the appropriate regulations. Do not dispose of the products with other industrial waste or with domestic garbage.

___ The products described in this document are subject to the foreign exchange and foreign trade laws.

___ The information contained herein is presented only as a guide for the applications of our products. No responsibility is assumed by ISOCOM Components for any infringements of intellectual property or other rights of the third parties which may result from its use. No license is granted by implication or otherwise under any intellectual property or other rights of ISOCOM Components or others.

___ The information contained herein is subject to change without notice.