



NDT456P

P-Channel Enhancement Mode Field Effect Transistor

General Description

Power SOT P-Channel enhancement mode power field effect transistors are produced using Fairchild's proprietary, high cell density, DMOS technology. This very high density process is especially tailored to minimize on-state resistance and provide superior switching performance. These devices are particularly suited for low voltage applications such as notebook computer power management, battery powered circuits, and DC motor control.

Features

- -7.5 A, -30 V. $R_{DS(ON)} = 0.030 \Omega @ V_{GS} = -10 \text{ V}$
 $R_{DS(ON)} = 0.045 \Omega @ V_{GS} = -4.5 \text{ V}$
- High density cell design for extremely low $R_{DS(ON)}$
- High power and current handling capability in a widely used surface mount package.

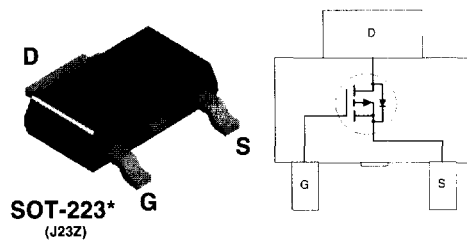
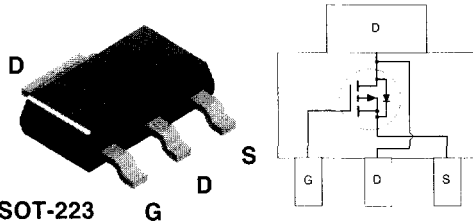

4

Absolute Maximum Ratings $T_A = 25^\circ\text{C}$ unless otherwise noted

Symbol	Parameter	NDT456P	Units
V_{DS}	Drain-Source Voltage	-30	V
V_{GS}	Gate-Source Voltage	± 20	V
I_D	Drain Current - Continuous (Note 1a)	± 7.5	A
	- Pulsed	± 20	
P_D	Maximum Power Dissipation (Note 1a)	3	W
	(Note 1b)	1.3	
	(Note 1c)	1.1	
T_J, T_{STG}	Operating and Storage Temperature Range	-65 to 150	$^\circ\text{C}$

THERMAL CHARACTERISTICS

$R_{\theta JA}$	Thermal Resistance, Junction-to-Ambient (Note 1a)	42	$^\circ\text{C/W}$
$R_{\theta JC}$	Thermal Resistance, Junction-to-Case (Note 1)	12	$^\circ\text{C/W}$

Electrical Characteristics (T _A = 25°C unless otherwise noted)						
Symbol	Parameter	Conditions	Min	Typ	Max	Units
OFF CHARACTERISTICS						
BV _{DSS}	Drain-Source Breakdown Voltage	V _{GS} = 0 V, I _D = 250 μA	-30			V
I _{DSS}	Zero Gate Voltage Drain Current	V _{DS} = -24 V, V _{GS} = 0 V			-1	μA
		T _J = 55°C			-10	μA
I _{GSSF}	Gate - Body Leakage, Forward	V _{GS} = 20 V, V _{DS} = 0 V			100	nA
I _{GSSR}	Gate - Body Leakage, Reverse	V _{GS} = -20 V, V _{DS} = 0 V			-100	nA
ON CHARACTERISTICS (Note 2)						
V _{GS(th)}	Gate Threshold Voltage	V _{DS} = V _{GS} , I _D = -250 μA	-1	-1.5	-3	V
		T _J = 125°C	-0.5	-1.1	-2.6	
R _{DS(on)}	Static Drain-Source On-Resistance	V _{GS} = -10 V, I _D = -7.5 A		0.026	0.03	Ω
		T _J = 125°C		0.035	0.054	
		V _{GS} = -4.5 V, I _D = -6 A		0.041	0.045	
I _{D(on)}	On-State Drain Current	V _{GS} = -10 V, V _{DS} = -5 V	-20			A
		V _{GS} = -4.5 V, V _{DS} = -5 V	-10			
G _s	Forward Transconductance	V _{GS} = -10 V, I _D = -7.5 A		13		S
DYNAMIC CHARACTERISTICS						
C _{iss}	Input Capacitance	V _{DS} = -15 V, V _{GS} = 0 V, f = 1.0 MHz		1440		pF
C _{oss}	Output Capacitance			905		pF
C _{rss}	Reverse Transfer Capacitance			355		pF
SWITCHING CHARACTERISTICS (Note 2)						
t _{D(on)}	Turn - On Delay Time	V _{DD} = -15 V, I _D = -7 A, V _{GEN} = -10 V, R _{GEN} = 12 Ω		10	20	ns
t _r	Turn - On Rise Time			65	120	ns
t _{D(off)}	Turn - Off Delay Time			70	130	ns
t _f	Turn - Off Fall Time			70	130	ns
Q _g	Total Gate Charge	V _{DS} = -10 V, I _D = -7.5 A, V _{GS} = -10 V		47	67	nC
Q _{gs}	Gate-Source Charge			5		nC
Q _{gd}	Gate-Drain Charge			12		nC

Electrical Characteristics ($T_A = 25^\circ\text{C}$ unless otherwise noted)

Symbol	Parameter	Conditions	Min	Typ	Max	Units
DRAIN-SOURCE DIODE CHARACTERISTICS AND MAXIMUM RATINGS						
I_S	Maximum Continuous Drain-Source Diode Forward Current				-2.5	A
V_{SD}	Drain-Source Diode Forward Voltage	$V_{GS} = 0\text{ V}, I_S = -2.5\text{ A}$ (Note 2)		-0.85	-1.2	V
t_{rr}	Reverse Recovery Time	$V_{GS} = 0\text{ V}, I_F = -2.5\text{ A } dI_F/dt = 100\text{ A}/\mu\text{s}$			140	ns

Notes:

- $$P_D(t) = \frac{T_J - T_A}{R_{\theta JA}(t)} = \frac{T_J - T_A}{R_{\theta JC} + R_{\theta CA}(t)} = I_D^2(t) \times R_{DS(on)@T_J}$$
 $R_{\theta JA}$ is the sum of the junction-to-case and case-to-ambient thermal resistance where the case thermal reference is defined as the solder mounting surface of the drain pins. $R_{\theta JC}$ is guaranteed by design while $R_{\theta CA}$ is defined by users. For general reference: Applications on 4.5"x5" FR-4 PCB under still air environment, typical $R_{\theta JA}$ is found to be:
 - 42°C/W when mounted on a 1 in² pad of 2oz copper.
 - 95°C/W when mounted on a 0.066in² pad of 2oz copper.
 - 110°C/W when mounted on a 0.00123in² pad of 2oz copper.

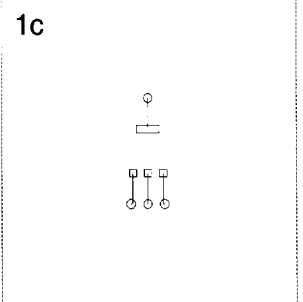
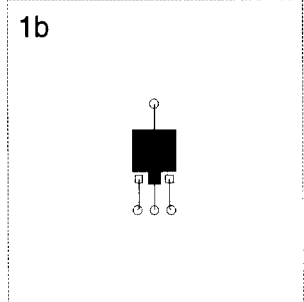
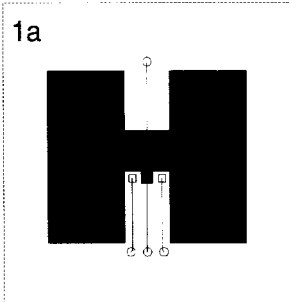

Scale 1 : 1 on letter size paper
 2. Pulse Test: Pulse Width ≤ 300μs, Duty Cycle ≤ 2.0%.

Typical Electrical Characteristics

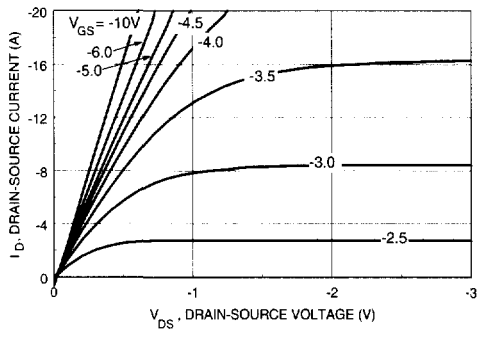

Figure 1. On-Region Characteristics.

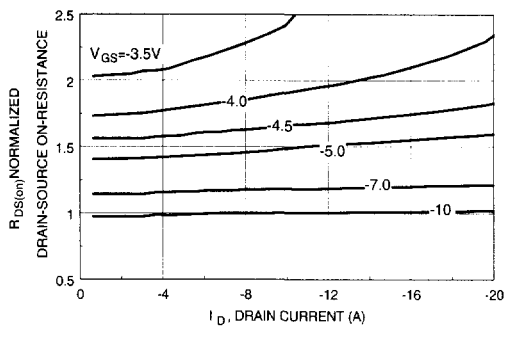

Figure 2. On-Resistance Variation with Gate Voltage and Drain Current.

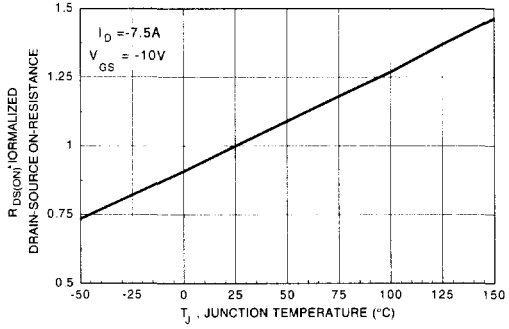

Figure 3. On-Resistance Variation with Temperature.

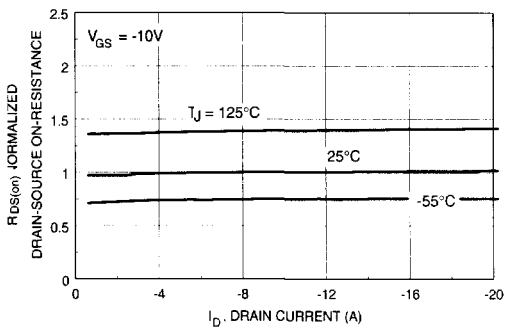

Figure 4. On-Resistance Variation with Drain Current and Temperature.

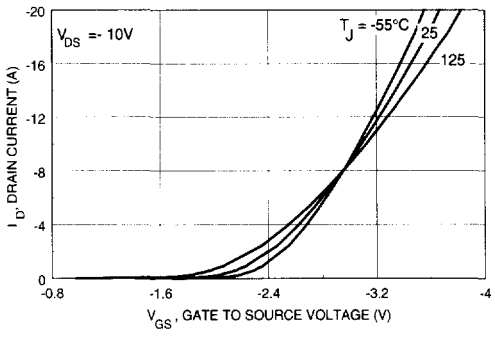

Figure 5. Transfer Characteristics.

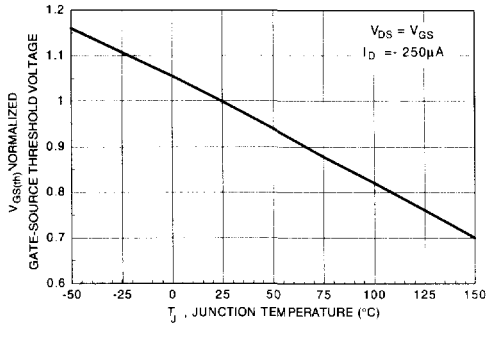

Figure 6. Gate Threshold Variation with Temperature.

Typical Electrical Characteristics

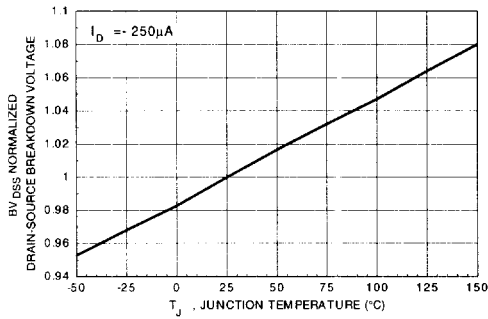

Figure 7. Breakdown Voltage Variation with Temperature.

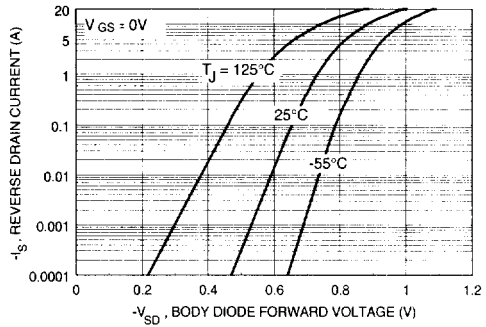

Figure 8. Body Diode Forward Voltage Variation with Current and Temperature.

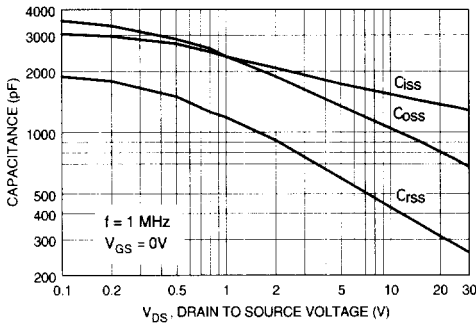

Figure 9. Capacitance Characteristics.

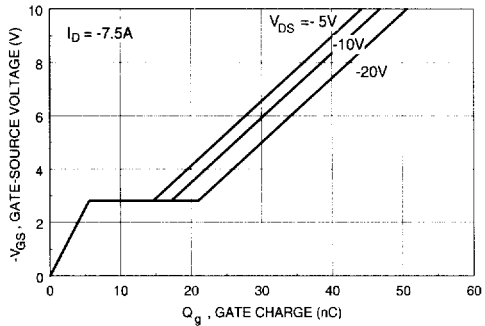

Figure 10. Gate Charge Characteristics.

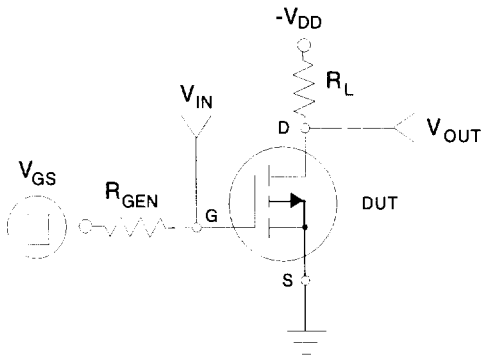

Figure 11. Switching Test Circuit.

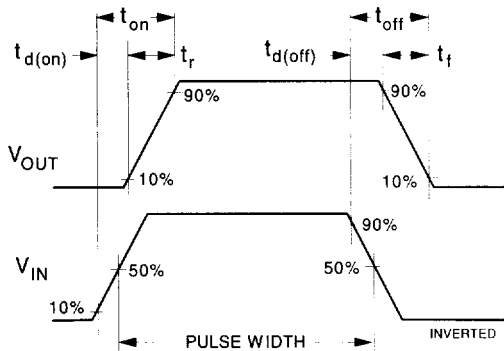

Figure 12. Switching Waveforms.

Typical Thermal Characteristics

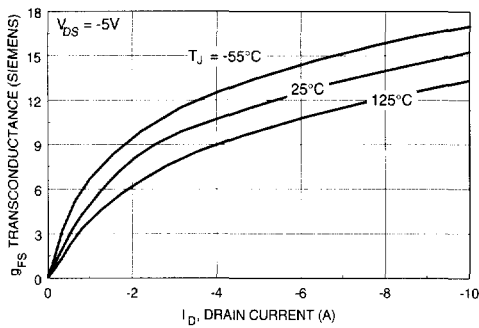

Figure 13. Transconductance Variation with Drain Current and Temperature.

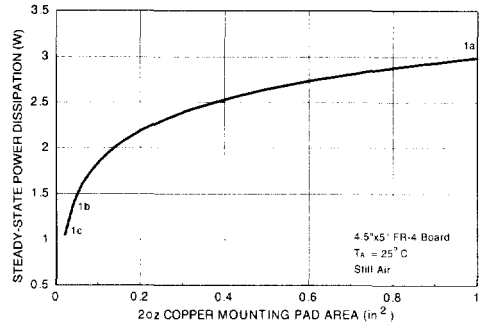

Figure 14. SOT-223 Maximum Steady-State Power Dissipation versus Copper Mounting Pad Area.

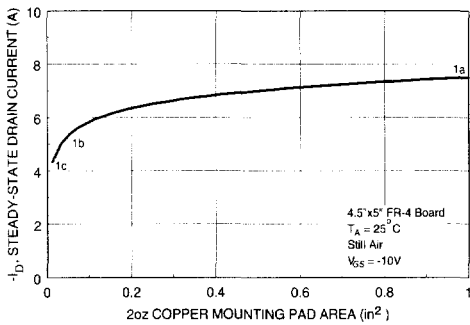

Figure 15. Maximum Steady-State Drain Current versus Copper Mounting Pad Area.

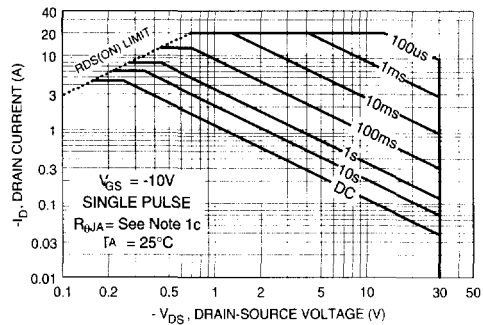

Figure 16. Maximum Safe Operating Area.

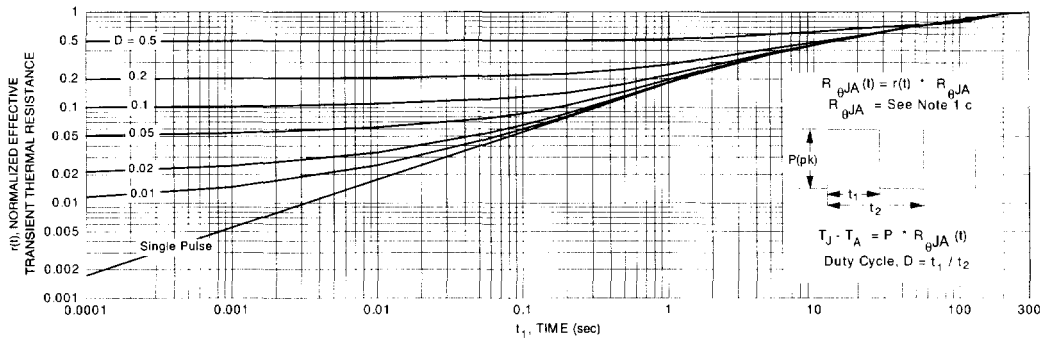

Figure 17. Transient Thermal Response Curve.

Note: Thermal characterization performed using the conditions described in note 1c. Transient thermal response will change depending on the circuit board design.