

# 2SA1667/1668

Silicon PNP Epitaxial Planar Transistor (Complement to type 2SC4381/4382)

Application : TV Vertical Output, Audio Output Driver and General Purpose

■ Absolute maximum ratings (Ta=25°C)

Symbol	Ratings		Unit
	2SA1667	2SA1668	
VcBO	-150	-200	V
VcEO	-150	-200	V
VEBO	-6		V
Ic	-2		A
Ib	-1		A
Pc	25(Tc=25°C)		W
Tj	150		°C
Tstg	-55 to +150		°C

■ Electrical Characteristics (Ta=25°C)

Symbol	Conditions	Ratings		Unit
		2SA1667	2SA1668	
IcBO	VcB=	-10max	-10max	μA
IEBO	VEB=-6V	-10max		μA
V(BR)CEO	Ic=-25mA	-150min	-200min	V
hFE	VCE=-10V, Ic=-0.7A	60min		
VCE(sat)	Ic=-0.7A, Ib=-0.07A	-1.0max		V
fr	VCE=-12V, IE=0.2A	20typ		MHz
COB	VcB=-10V, f=1MHz	60typ		pF

External Dimensions FM20 (TO220F)

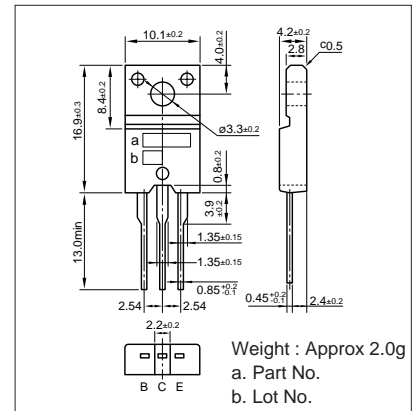

■ Typical Switching Characteristics (Common Emitter)

VCC (V)	RL (Ω)	Ic (A)	VBB1 (V)	VBB2 (V)	Ib1 (mA)	Ib2 (mA)	ton (μs)	tstg (μs)	tf (μs)
-20	20	-1	-10	5	-100	100	0.4typ	1.5typ	0.5typ

Ic-VCE Characteristics (Typical)

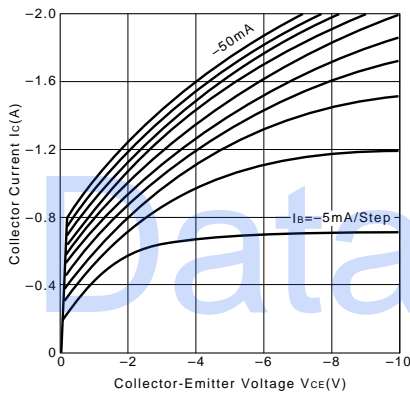

VCE(sat)-Ib Characteristics (Typical)

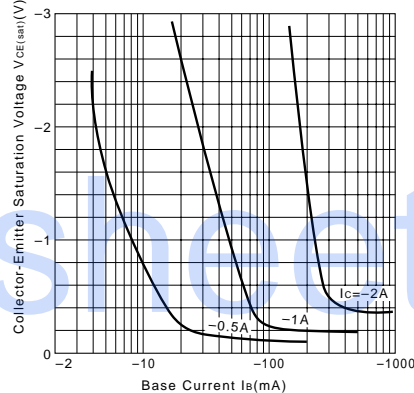

Ic-VBE Temperature Characteristics (Typical)

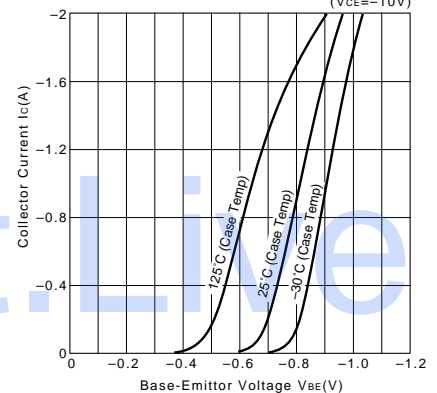

hFE-Ic Characteristics (Typical)

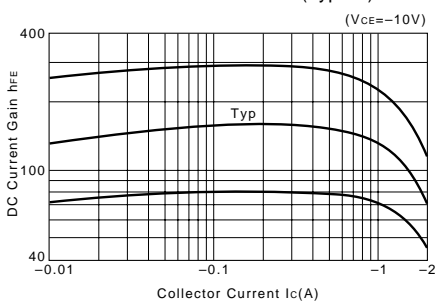

hFE-Ic Temperature Characteristics (Typical)

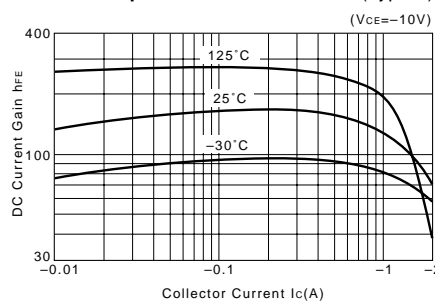

θj-a-t Characteristics

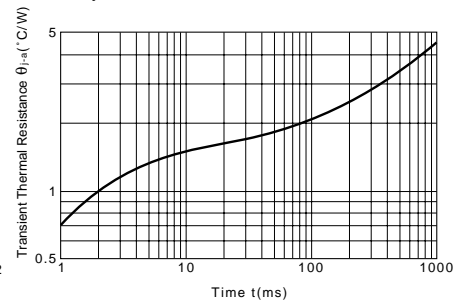

fr-IE Characteristics (Typical)

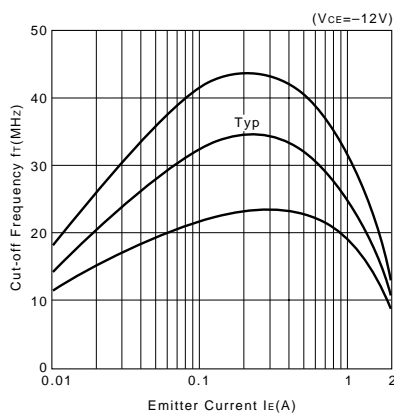

Safe Operating Area (Single Pulse)

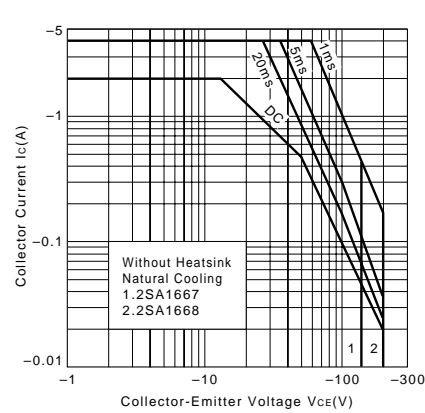

Pc-Ta Derating

