

The TL494 is a fixed frequency, pulse width modulation control circuit designed primarily for Switchmode power supply control. This device features:

- Complete Pulse Width Modulation Control Circuitry
- On-Chip Oscillator With Master Or Slave Operation
- On-Chip Error Amplifiers
- On-Chip 5 Volt Reference
- Adjustable Dead-Time Control
- Uncommitted Output Transistors Rated to 500mA Source Or Sink
- Output Control For Push-Pull Or Single-Ended Operation
- Undervoltage Lockout

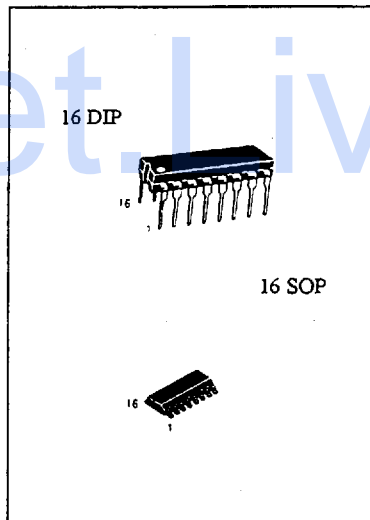
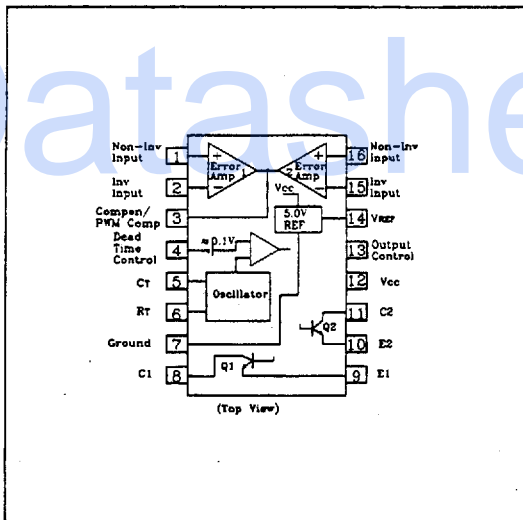

The TL494C is specified over the commercial operating range of 0°C to 70°C. The TL494I is specified over the industrial range of -25°C to 85°C.

ORDERING INFORMATION

Device	Temperature Range	Package
TL494CD	0°C to +70°C	Plastic DIP
TL494ID	-25°C to +85°C	Plastic DIP

FIGURE 1-BLOCK DIAGRAM

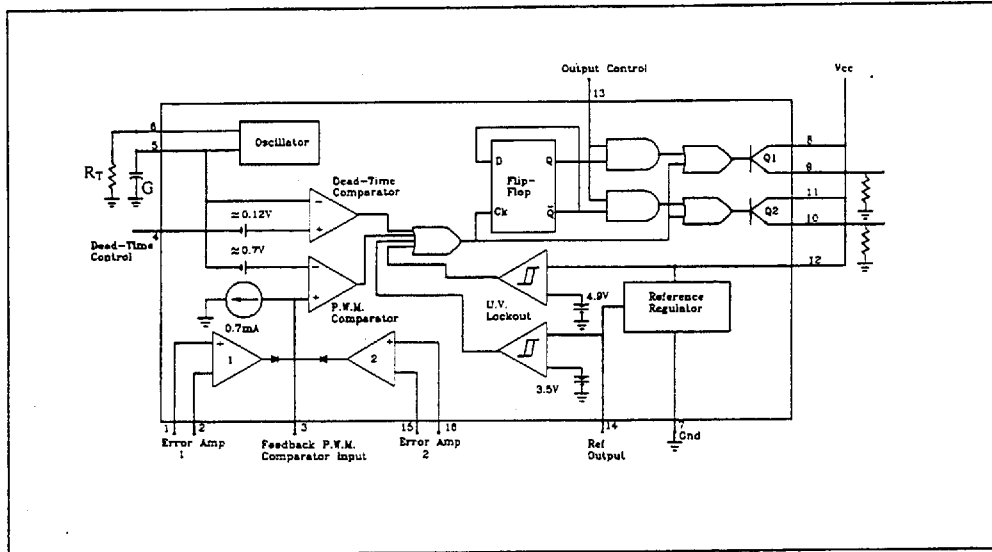
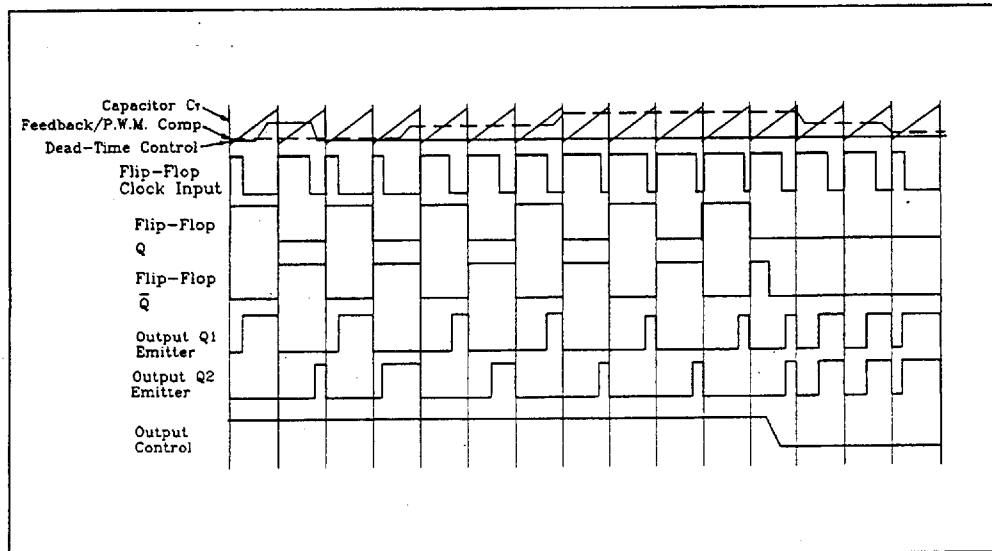

FIGURE 2- TIMING DIAGRAM



MAXIMUM RATINGS (Full operating ambient temperature range applies unless otherwise noted)

Rating	Symbol	TL494CD	TL494ID	Unit
Power Supply Voltage	V_{CC}	42	42	V
Collector Output Voltage	V_{C1}, V_{C2}	42	42	V
Collector Output Current (each transistor) (1)	I_{C1}, I_{C2}	500	500	mA
Amplifier Input Voltage Range	V_R	-0.3 to 42	-0.3 to 42	V
Power Dissipation @ $T_A \leq 45^\circ\text{C}$	P_D	1000	1000	mW
Operating Junction Temperature Plastic Package	T_J	125	125	$^\circ\text{C}$
Operating Ambient Temperature Range	T_A	0 to 70	-25 to 85	$^\circ\text{C}$
Storage Temperature Range Plastic Package	T_{stg}	-55 to 125	-55 to 125	$^\circ\text{C}$

NOTE 1: Maximum thermal limits must be observed.

THERMAL CHARACTERISTICS

Characteristics	Symbol	16 DIP Plastic Package	Unit
Thermal Resistance, Junction to Ambient	$R_{\theta JA}$	80	$^\circ\text{C/W}$
Derating Ambient Temperature	T_A	45	$^\circ\text{C}$

RECOMMENDED OPERATING CONDITIONS

Condition/Value	Symbol	TL494			Unit
		Min	Typ	Max	
Power Supply Voltage	V_{CC}	7.0	15	40	V
Collector Output Voltage	V_{C1}, V_{C2}	-	30	40	V
Collector Output Current (each transistor)	I_{C1}, I_{C2}	-	-	200	mA
Amplifier Input Voltage	V_{in}	-0.3	-	$V_{CC}-2.0$	V
Current Into Feedback Terminal	I_F	-	-	0.3	mA
Reference Output Current	I_{ref}	-	-	10	mA
Timing Resistor	R_T	1.8	30	500	$K\Omega$
Timing Capacitor	C_T	0.0047	0.001	10	μF
Oscillator Frequency	f_{osc}	1.0	40	200	KHz

ELECTRICAL CHARACTERISTICS ($V_{CC}=15\text{V}, C_T=0.01\mu\text{F}, R_T=12K\Omega$ unless otherwise noted.)

For typical values $T_A = 25^\circ\text{C}$, for min/max values T_A is operating ambient temperature range that applies unless otherwise noted.

*Characteristic	Symbol	TL494C.ID			Unit
		Min	Typ	Max	

REFERENCE SECTION

Reference Voltage ($I_o = 1.0\text{mA}$)	V_{ref}	4.90	5.0	5.10	V
Line Regulation ($V_{CC} = 7.0\text{V to } 40\text{V}$)	REGline	-	2.0	25	mV
Load Regulation ($I_o = 1.0\text{mA to } 10\text{mA}$)	REGload	-	3.0	15	mV
Short-Circuit Output Current ($V_{ref} = 0\text{V}$)	I_{sc}	15	35	75	mA

ELECTRICAL CHARACTERISTICS ($V_{CC}=15V$, $C_T=0.01\mu F$, $R_T=12K\Omega$ unless otherwise noted.)

For typical values $T_A=25^\circ C$, for min/max values T_A is the operating ambient temperature range that applies unless otherwise noted.

Characteristic	Symbol	TL494C, ID			Unit
		Min	Typ	Max	
OUTPUT SECTION					
Collector Off-State Current ($V_{CC}=40V$, $V_{CE}=40V$)	$I_{CO(0)}$	-	2.0	100	μA
Emitter Off-State Current ($V_{CC}=40V$, $V_C=40V$, $V_E=0V$)	$I_{EO(0)}$	-	-	-100	μA
Collector-Emitter Saturation Voltage(2) Common-Emitter ($V_E=0V$, $I_C=200mA$)	$V_{SAT(C)}$	-	1.1	1.3	V
Emitter-Follower ($V_C=15V$, $I_E=-200mA$)	$V_{SET(E)}$	-	1.5	2.5	V
Output Control Pin Current Low State ($V_{OC}\leq 0.4V$)	I_{OCL}	-	10	-	μA
High State ($V_{OC}=V_{CC}$)	I_{OCH}	-	0.2	3.5	mA
Output Voltage Rise Time Common-Emitter (See Figure 13) Emitter-Follower (See Figure 14)	t_r	-	100	200	ns
Output Voltage Fall Time Common-Emitter (See Figure 13) Emitter-Follower (See Figure 14)	t_f	-	25	100	ns
		-	40	100	ns

Characteristic	Symbol	TL494			Unit
		Min	Typ	Max	
ERROR AMPLIFIER SECTION					
Input Offset Voltage (V_O (Pin 3) = 2.5V)	V_{IO}	-	2.0	10	mV
Input Offset Current (V_O (Pin 3) = 2.5V)	V_{IO}	-	5.0	250	nA
Input Bias Current (V_O (Pin 3) = 2.5V)	I_{IB}	-	-0.1	-1.0	μA
Input Common-Mode Voltage Range ($V_{CC}=40V$, $T_A=25^\circ C$)	V_{ICR}	-0.3V to $V_{CC}-2.0$	-	-	V
Open-Loop Voltage Gain ($\Delta V_O=3.0V$, $V_O=0.5$ to 3.5V, $R_L=2.0K\Omega$)	A_{VOL}	70	95	-	dB
Unity-Gain Crossover Frequency ($V_O=0.5$ to 3.5V, $R_L=2.0K\Omega$)	f_c	-	350	-	KHz
Phase Margin at Unity-Gain ($V_O=0.5$ to 3.5V, $R_L=2.0K\Omega$)	θ_m	-	65	-	deg.
Common-Mode Rejection Ratio ($V_{CC}=40V$)	CMRR	65	90	-	dB
Power Supply Rejection Ratio ($\Delta V_{CC}=33V$, $V_O=2.5$, $R_L=2.0K\Omega$)	PSRR	-	100	-	dB
Output Sink Current (V_O (Pin 3) = 0.7V)	I_O^-	0.3	0.7	-	mA
Output Source Current (V_O (Pin 3) = 3.5V)	I_O^+	-2.0	-4.0	-	mA

NOTE 2: Low duty cycle pulse temperature are used during test to maintain junction as close to ambient temperatures as possible.

ELECTRICAL CHARACTERISTICS ($V_{CC}=15V, C_T=0.01\mu, F, R_T=12K\Omega$ unless otherwise noted.)

For typical values $T_A = 25^\circ C$, for min/max values T_A is operating ambient temperature range that applies unless otherwise noted.

Characteristic	Symbol	TL494			Unit
		Min	Typ	Max	
PWM COMPARATOR SECTION (Test Circuit Figure 12)					
Input Threshold Voltage (Zero duty cycle)	V_{TH}	-	3.5	4.5	V
Input Sink Current ($V_o(\text{Pin } 3)=0.7V$)	I_L	0.3	0.7	-	mA
DEAD-TIME CONTROL SECTION (Test Circuit Figure 12)					
Input Bias Current (Pin 4) ($V_{pin 4} = 0$ to 5.25V)	$I_{IB(DT)}$	-	-2.0	-10	μA
Maximum Duty Cycle, Each Output, Push-Pull Mode ($V_{pin 4} = 0V, C_T = 0.01\mu, F, R_T = 12K\Omega$) ($V_{pin 4} = 0V, C_T = 0.001\mu, F, R_T = 30K\Omega$)	DC_{max}	45 -	48 45	50 50	%
Input Threshold Voltage (Pin 4) (Zero Duty Cycle) (Maximum Duty Cycle)	V_{TH}	- 0	2.8 -	3.3 -	V
OSCILLATOR SECTION					
Frequency ($C_T = 0.001\mu, F, R_T = 30K\Omega$)	f_{osc}	-	40	-	KHz
Standard Deviation of Frequency* ($C_T = 0.001\mu, F, R_T = 30K\Omega$)	δf_{osc}	-	3.0	-	%
Frequency Change with Voltage ($V_{CC} = 7.0V$ to 40V, $T_A = 25^\circ C$)	$\Delta f_{osc}(\Delta V)$	-	0.1	-	%
Frequency Change with Temperature ($\Delta T_A = T_{low}$ to T_{high}) ($C_T = 0.01\mu, F, R_T = 12K\Omega$)	$\Delta f_{osc}(\Delta T)$	-	-	12	%
UNDERVOLTAGE LOCKOUT SECTION					
Turn-On Threshold (V_{CC} Increasing, $I_{ref} = 1.0mA$)	V_{th}	5.5	6.43	7.0	V
TOTAL DEVICE					
Standby Supply Current (Pin 6 at V_{ref} , All Other Inputs and Outputs Open) ($V_{CC} = 15V$) ($V_{CC} = 40V$)	I_{CC}	- -	5.5 7.0	10 15	mA
Average Supply Current ($V(\text{Pin } 4) = 2.0V$) (See Figure 12) ($C_T = 0.01\mu, F, R_T = 12K\Omega, V_{CC} = 15V$)	-	-	7.0	-	mA

- Standard deviation is a measure of the statistical distribution about the mean as derived from the formula,

$$\sqrt{\frac{\sum_{n=1}^N (X_n - \bar{X})^2}{N-1}}$$

FIGURE 4-OSCILLATOR FREQUENCY versus TIMING RESISTANCE

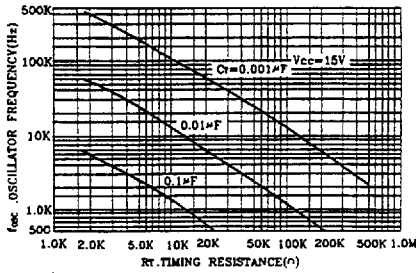

FIGURE 6-PERCENT DEAD-TIME versus OSCILLATOR FREQUENCY

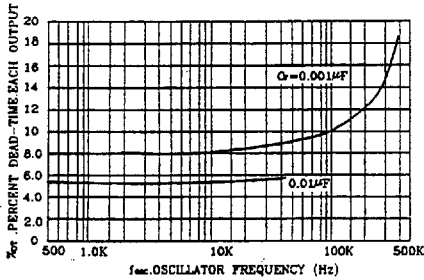

FIGURE 8-EMITTER FOLLOWER CONFIGURATION OUTPUT SATURATION VOLTAGE versus EMITTER CURRENT

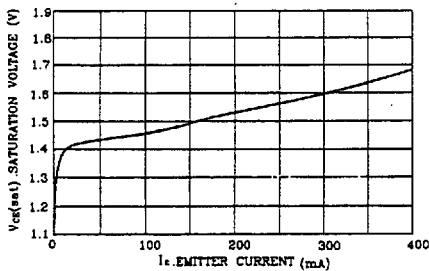

FIGURE 5-OPEN-LOOP VOLTAGE GAIN AND PHASE versus FREQUENCY

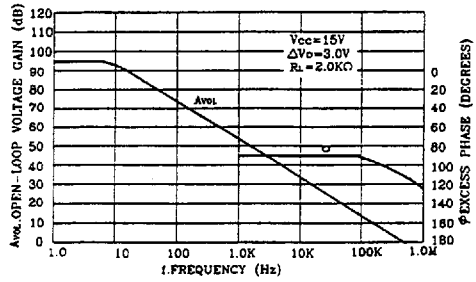

FIGURE 7-PERCENT DUTY CYCLE versus DEAD-TIME CONTROL VOLTAGE

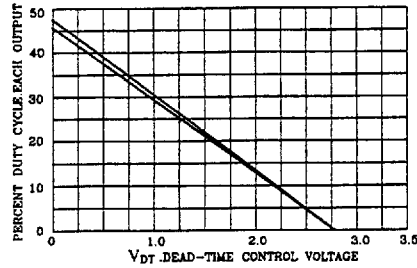

FIGURE 9-COMMON EMITTER CONFIGURATION OUTPUT SATURATION VOLTAGE versus COLLECTOR CURRENT

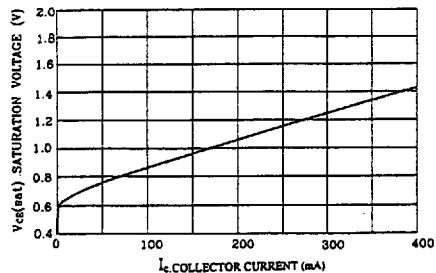

FIGURE 10-STANDBY SUPPLY CURRENT versus SUPPLY VOLTAGE

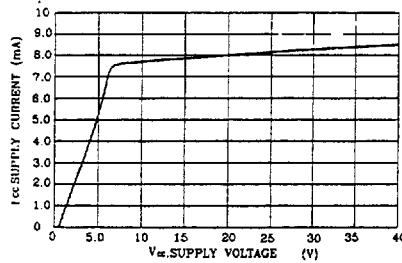

FIGURE 11-ERROR AMPLIFIER CHARACTERISTICS

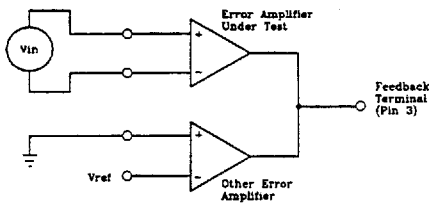

FIGURE 12-DEAD-TIME AND FEED-BACK CONTROL TEST CIRCUIT

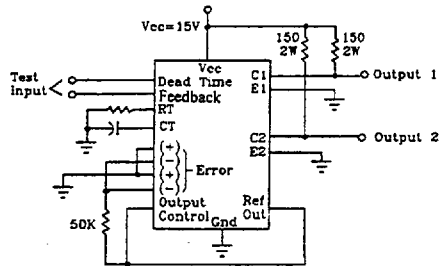

FIGURE 13-COMMON-EMITTER CONFIGURATION TEST CIRCUIT AND WAVEFORM

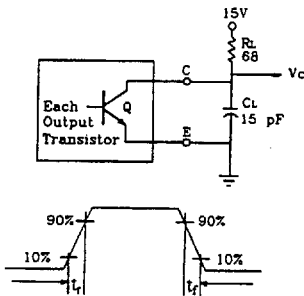

FIGURE 14-EMITTER-FOLLOWER CONFIGURATION TEST AND WAVEFORM CIRCUIT

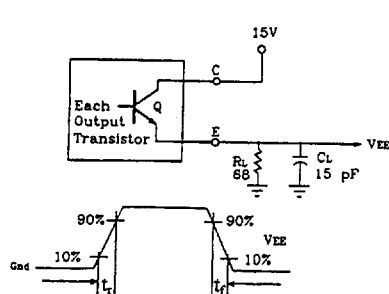

FIGURE 15-ERROR-AMPLIFIER SENSING TECHNIQUES

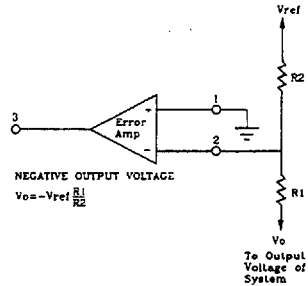
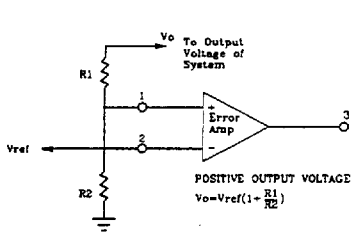

FIGURE 16-DEAD-TIME CONTROL CIRCUIT

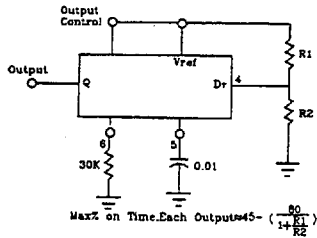

FIGURE 17-SOFT-START CIRCUIT

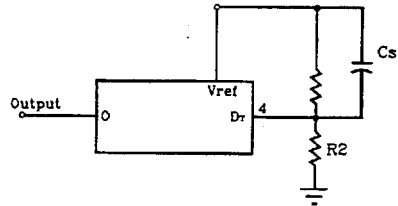

FIGURE 18-OUTPUT CONNECTIONS FOR SINGLE-ENDED AND PUSH-PULL CONFIGURATIONS

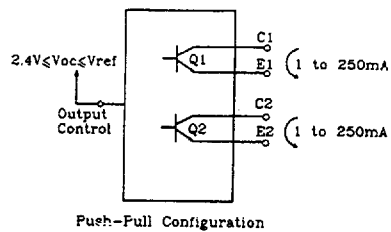
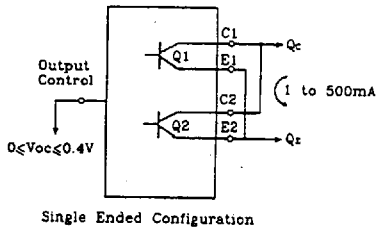

FIGURE 19-SLAVING TWO OR MORE MODE CONTROL CIRCUITS

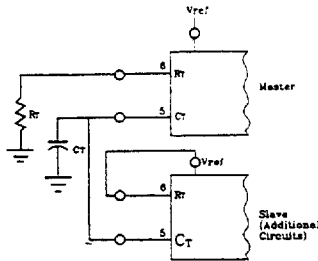

FIGURE 20-OPERATION WITH VIN>40V USING EXTERNAL ZENER

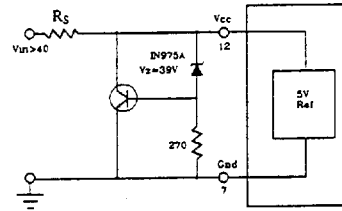
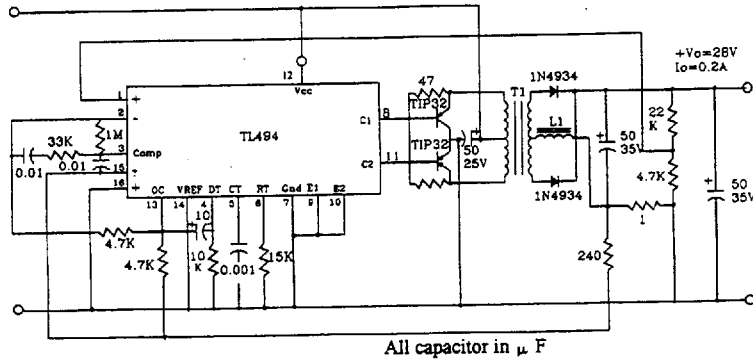

FIGURE 21-PULSE-WIDTH MODULATED PUSH-PULL CONVERTER
+Vin=8.0 to 20



L1-3.5mH @ 0.3A

T1-Primary : 20T C.T. #28 AWG

Secondary : 120T C.T. #36 AWG

Core : Ferroxcube 1408P-L00-3C8

TEST	CONDITIONS	RESULTS
Line Regulation	Vin = 10V to 40V	14mV 0.28%
Load Regulation	Vin = 28V, Io = 1mA to 1A	3.0mV 0.06%
Output Ripple	Vin = 28V, Io = 1.0A	65mV P-P P.A.R.D.
Short Circuit Current	Vin = 28V, RL=0.1 Ω	1.6 amps
Efficiency	Vin = 28V, Io = 1A	71%

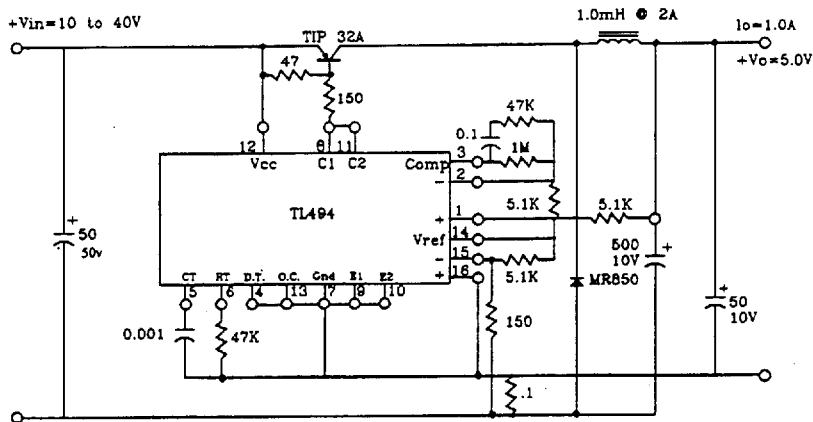
FIGURE 22-PULSE-WIDTH MODULATED STEP-DOWN CONVERTER

TEST	CONDITIONS	RESULTS
Line Regulation	$V_{in} = 8.0V$ to $40V$	3.0mV 0.01%
Load Regulation	$V_{in} = 12.6V$, $I_o = 0.2$ to $200mA$	5.0mV 0.02%
Output Ripple	$V_{in} = 12.6V$, $I_o = 200mA$	40mVp-P P.A.R.D.
Short Circuit Current	$V_{in} = 12.6V$, $R_L = 0.1\Omega$	250mA
Efficiency	$V_{in} = 12.6V$, $I_o = 200mA$	72%

Description

The TL494 is a fixed-frequency pulse width modulation control circuit, incorporating the primary building blocks required for the control of a switching power supply. (See Figure 1.) An internal-linear sawtooth oscillator is frequency-programmable by two external components, R_T and C_T . The approximate oscillator frequency is determined by:

$$f_{osc} \approx \frac{1.1}{R_T \cdot C_T}$$

For more information refer to Figure 4.

Output pulse width modulation is accomplished by comparison of the positive sawtooth waveform across capacitor C_T to either of two control signals. The NOR gates, which drive output transistors Q1 and Q2, are enabled only when the flip-flop clock-input line is in its low state. This happens only during that portion of time when the sawtooth voltage is greater than the control signals. Therefore, an increase in control-signal amplitude causes a corresponding linear decrease of output pulse width. (Refer to the timing diagram shown in Figure 2.)

The control signals are external inputs that can be fed into the dead-time control, the error amplifier inputs, or the feedback input. The dead-time control comparator has an effective 120 mV input offset which limits the minimum output dead time to approximately the first 4% of the sawtooth-cycle time. This would result in a maximum duty cycle on a given output of 96% with the output control grounded, and 48% with it connected to the reference line. Additional dead time may be imposed on the output by setting the dead time-control input to a fixed voltage, ranging between 0 to 3.3V.

The pulse width modulator comparator provides a means for the error amplifiers to adjust the output pulse width from the maximum percent on-time, established by the dead time control input, down to zero, as the voltage at the feedback pin varies from 0.5 to 3.5V. Both error amplifiers have a common-mode input range from -0.3V to $(V_{CC}-2V)$, and may be used to sense power-supply output voltage and current. The error -amplifier outputs are active high and are Ored together at the non-inverting input of the pulse-width modulator comparator. With this configuration, the amplifier that demands minimum output on time, dominates control of the loop.

When capacitor C_T is discharged, a positive pulse is generated on the output of the dead-time comparator, which clocks the pulse-steering flip-flop and inhibits the output transistors, Q1 and Q2. With the output-control connected to the reference line, the pulse-steering flip-flop directs the modulated pulse to each of the two output transistors alternately for push-pull operation. The output frequency is equal to half that of the oscillator. Output drive can also be taken from Q1 or Q2, when single-ended operation with a maximum on-time of less than 50% is required. This is desirable when the output transformer has a ringback winding with a catch diode used for snubbing. When higher out-drive currents are required for single-ended operation, Q1 and Q2 may be connected in parallel, and the output-mode pin must be tied to ground to disable the flip-flop. The output frequency will now be equal to that of the oscillator.

The TL494 has an internal 5V reference capable of sourcing up to 10mA of load current for external bias circuits. The reference has an internal accuracy of $\pm 1.5\%$ with a typical thermal drift of less than 50 mV over an operating range of 0 to 70 °C.

FIGURE 3-FUNCTIONAL TABLE

Input output Control	Output Function	$\frac{f_{out}}{f_{osc}} =$
Grounded	Single-ended P.W.M. at Q1 and Q2	1
At Vref	Push-pull operation	0.5