

0.5mm Pitch

SERIES

6238

0.5mmピッチ RA SMT ワンタッチロックタイプ
0.5mm Pitch RA SMT One-Touch Lock Type

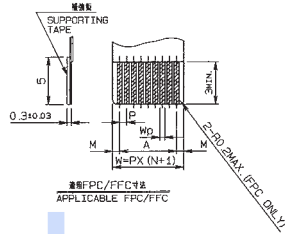
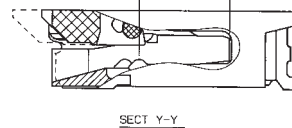
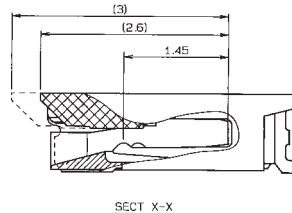
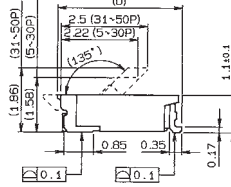
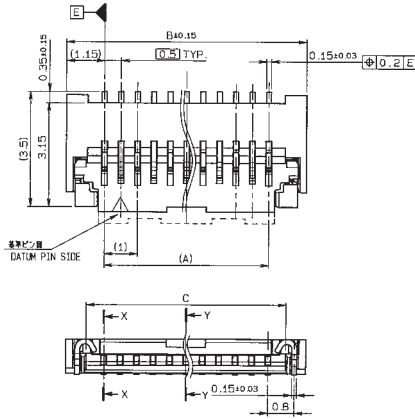

	FFC		FFC	
	1	2	1	2
M	0.54±0.12	0.54±0.1	0.54±0.1	0.54±0.08
P	0.54±0.02	0.54±0.05	0.54±0.03	0.54±0.05
A	A±0.03	A±0.05	A±0.03	A±0.05
W	W±0.07	W±0.07	W±0.07	W±0.07
WD	0.35±0.03	0.35±0.05	0.35±0.03	0.35±0.05

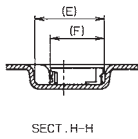
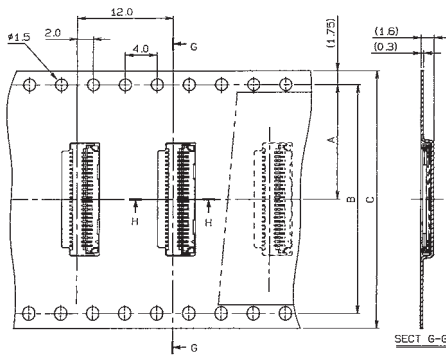
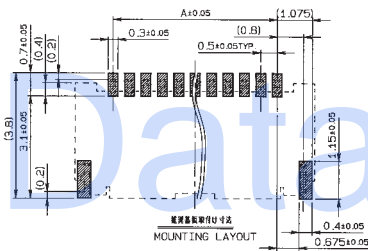

極数 NO. OF POS	A	B	C	D
5 小極	2.0	4.3	3.1	3.6
6	2.5	4.8	3.6	3.6
7	3.0	5.3	4.1	3.6
8	3.5	5.8	4.6	3.6
9	4.0	6.3	5.1	3.6
10	4.5	6.8	5.6	3.6
11	5.0	7.3	6.1	3.6
12	5.5	7.8	6.6	3.6
13	6.0	8.3	7.1	3.6
14	6.5	8.8	7.6	3.6
15	7.0	9.3	8.1	3.6
16	7.5	9.8	8.6	3.6
17	8.0	10.3	9.1	3.6
18	8.5	10.8	9.6	3.6
19	9.0	11.3	10.1	3.6
20 中極	9.5	11.8	10.6	3.6
21	10.0	12.3	11.1	3.6
22	10.5	12.8	11.6	3.6
23	11.0	13.3	12.1	3.6
24	11.5	13.8	12.6	3.6
25	12.0	14.3	13.1	3.6
26	12.5	14.8	13.6	3.6
27	13.0	15.3	14.1	3.6
28	13.5	15.8	14.6	3.6
29	14.0	16.3	15.1	3.6
30	14.5	16.8	15.6	3.6

極数 NO. OF POS	A	B	C	D
31 大極	15.0	17.3	16.1	4.0
32	15.5	17.8	16.6	4.0
33	16.0	18.3	17.1	4.0
34	16.5	18.8	17.6	4.0
35	17.0	19.3	18.1	4.0
36	17.5	19.8	18.6	4.0
37	18.0	20.3	19.1	4.0
38	18.5	20.8	19.6	4.0
39	19.0	21.3	20.1	4.0
40	19.5	21.8	20.6	4.0
41	20.0	22.3	21.1	4.0
42	20.5	22.8	21.6	4.0
43	21.0	23.3	22.1	4.0
44	21.5	23.8	22.6	4.0
45	22.0	24.3	23.1	4.0
46	22.5	24.8	23.6	4.0
47	23.0	25.3	24.1	4.0
48	23.5	25.8	24.6	4.0
49	24.0	26.3	25.1	4.0
50	24.5	26.8	25.6	4.0

極数 NO. OF POS	A	B	C	E	F
5	7.5	—	16.0	—	—
6	7.5	—	16.0	—	—
7	7.5	—	16.0	—	—
8	7.5	—	16.0	—	—
9	7.5	—	16.0	—	—
10	7.5	—	16.0	—	—
11	7.5	—	16.0	—	—
12	7.5	—	16.0	—	—
13	7.5	—	16.0	—	—
14	11.5	—	24.0	—	—
15	11.5	—	24.0	—	—
16	11.5	—	24.0	—	—
17	11.5	—	24.0	—	—
18	11.5	—	24.0	—	—
19	11.5	—	24.0	—	—
20	11.5	—	24.0	—	—
21	11.5	—	24.0	—	—
22	11.5	—	24.0	—	—
23	11.5	—	24.0	—	—
24	11.5	—	24.0	—	—
25	11.5	—	24.0	—	—
26	11.5	—	24.0	—	—
27	11.5	—	24.0	—	—
28	14.2	28.4	32.0	—	—
29	14.2	28.4	32.0	—	—
30	14.2	28.4	32.0	—	—
31	14.2	28.4	32.0	—	—
32	14.2	28.4	32.0	—	—
33	14.2	28.4	32.0	—	—
34	14.2	28.4	32.0	—	—
35	14.2	28.4	32.0	—	—
36	14.2	28.4	32.0	—	—
37	14.2	28.4	32.0	—	—
38	14.2	28.4	32.0	—	—
39	14.2	28.4	32.0	—	—
40	14.2	28.4	32.0	—	—
41	14.2	28.4	32.0	—	—
42	14.2	28.4	32.0	—	—
43	14.2	28.4	32.0	—	—
44	20.2	40.4	44.0	—	—
45	20.2	40.4	44.0	—	—
46	20.2	40.4	44.0	—	—
47	20.2	40.4	44.0	—	—
48	20.2	40.4	44.0	—	—
49	20.2	40.4	44.0	—	—
50	20.2	40.4	44.0	—	—

注文コード/Ordering Code

Part No. 04 6238 0xx 000 xxx

800:Sn-Cu
883: Au
極数 NUMBER OF CONTACTS

注) 生産対応可能極数については、営業部にご確認願います。