



FEATURES

- RoHS compliant
- Lead frame technology
- Single isolated output
- 1kVDC Isolation
- Efficiency up to 78%
- Power density 1.8W/cm³
- Wide temperature performance at full 1 Watt load, -40°C to 85°C
- UL 94V-0 Package material
- Footprint over pins 1.37cm²
- 3.3V, 5V & 12V Input
- 3.3V, 5V, 9V, 12V & 15V output
- No heatsink required
- Internal SMD construction
- Toroidal magnetics
- MTTF up to 6.8 million hours
- Custom solutions available
- Multi-layer ceramic capacitors

PRODUCT OVERVIEW

The NTE series of miniature surface mounted DC/DC Converters employ leadframe technology and transfer moulding techniques to bring all of the benefits of IC style packaging to hybrid circuitry. The co-planarity of the pin positions is based upon IEC 191-6:1990. The devices are suitable for all applications where high volume production is envisaged.

SELECTION GUIDE

Order Code ¹	Nominal Input Voltage	Output Voltage	Output Current	Input Current at Rated Load	Efficiency	Isolation Capacitance	MTTF ²
	V	V	mA	mA	%	pF	kHrs
NTE0303MC	3.3	3.3	303	410	73	30	5348
NTE0305MC	3.3	5	200	390	78	35	3847
NTE0309MC	3.3	9	111	400	77	31	3134
NTE0312MC	3.3	12	83	400	77	28	3473
NTE0315MC	3.3	15	66	400	77	29	2473
NTE0503MC	5	3.3	303	270	74	40	5515
NTE0505MC	5	5	200	294	68	35	6857
NTE0505MEC	5	5	200	260	77	40	3933
NTE0506MC	5	6	167	278	72	39	6677
NTE0509MC	5	9	111	267	75	43	5501
NTE0512MC	5	12	83	260	77	42	3957
NTE0515MC	5	15	66	256	78	44	2747
NTE1205MC	12	5	200	124	67	47	4683
NTE1209MC	12	9	111	114	73	77	4008
NTE1212MC	12	12	83	113	74	88	3121
NTE1215MC	12	15	66	111	75	95	2316

INPUT CHARACTERISTICS

Parameter	Conditions	Min.	Typ.	Max.	Units
Voltage range	Continuous operation, 3.3V input types	2.97	3.3	3.63	V
	Continuous operation, 5V input types	4.5	5.0	5.5	
	Continuous operation, 12V input types	10.8	12.0	13.2	
Reflected ripple current			30	47	mA p-p

ISOLATION CHARACTERISTICS

Parameter	Conditions	Min.	Typ.	Max.	Units
Isolation voltage	Flash tested for 1 second	1000			VDC
Resistance	Viso= 1000VDC	10			GΩ

GENERAL CHARACTERISTICS

Parameter	Conditions	Min.	Typ.	Max.	Units
Switching frequency	All output types		110		kHz

ABSOLUTE MAXIMUM RATINGS

Internal power dissipation	600mW
Input voltage V _{IN} , NTE03 types	5.5V
Input voltage V _{IN} , NTE05 types	7V
Input voltage V _{IN} , NTE12 types	15V

1. If components are required in tape and reel format suffix order code with -R, e.g. NTE0505MC-R.
2. Calculated using MIL-HDBK-217 FN2 calculation model with nominal input voltage at full load.
All specifications typical at T_A=25°C, nominal input voltage and rated output current unless otherwise specified.



For full details go to
www.murata-ps.com/rohs

OUTPUT CHARACTERISTICS					
Parameter	Conditions	Min.	Typ.	Max.	Units
Rated power	T _A =-40°C to 85°C			1.0	W
Voltage set point accuracy	See tolerance envelope				
Line regulation	High V _{IN} to low V _{IN}		1.0	1.2	%/%
Load regulation ¹	10% load to rated load, 03XXMC, 0503MC, 0505MEC		10	14	%
	10% load to rated load, 0505MC & 1205MC		12.8	15	
	10% load to rated load, 0506MC		9.2	10	
	10% load to rated load, 0509MC & 1209MC		8.3	9.0	
	10% load to rated load, 0512MC & 1212MC		6.8	7.5	
	10% load to rated load, 0515MC & 1215MC		6.3	7.0	
Ripple and noise	BW=DC to 20MHz, 03XXMC, 0503MC, 0505MEC		40	60	mV p-p
	BW=DC to 20MHz, 0505MC & 1205MC		62	85	
	BW=DC to 20MHz, 0506MC		103	170	
	BW=DC to 20MHz, 0509MC & 1209MC		49	75	
	BW=DC to 20MHz, 0512MC & 1212MC		39	65	
	BW=DC to 20MHz, 0515MC & 1215MC		38	76	

TEMPERATURE CHARACTERISTICS					
Parameter	Conditions	Min.	Typ.	Max.	Units
Specification	All output types	-40		85	°C
Storage		-55		125	
Case temperature rise above ambient	0305MC, 0309MC, 0315MC		25		
	0303MC, 0312MC, 0503MC, 0505MEC, 0509MC, 0512MC, 0515MC		30		
	0505MC, 1205MC		43		
	1209MC, 1212MC, 1215MC		40		
Cooling	Free air convection				

TECHNICAL NOTES

ISOLATION VOLTAGE

'Hi Pot Test', 'Flash Tested', 'Withstand Voltage', 'Proof Voltage', 'Dielectric Withstand Voltage' & 'Isolation Test Voltage' are all terms that relate to the same thing, a test voltage, applied for a specified time, across a component designed to provide electrical isolation, to verify the integrity of that isolation.

Murata Power Solutions NTE series of DC/DC converters are all 100% production tested at their stated isolation voltage. This is 1kVDC for 1 second.

A question commonly asked is, "What is the continuous voltage that can be applied across the part in normal operation?"

For a part holding no specific agency approvals, such as the NTE series, both input and output should normally be maintained within SELV limits i.e. less than 42.4V peak, or 60VDC. The isolation test voltage represents a measure of immunity to transient voltages and the part should never be used as an element of a safety isolation system. The part could be expected to function correctly with several hundred volts offset applied continuously across the isolation barrier; but then the circuitry on both sides of the barrier must be regarded as operating at an unsafe voltage and further isolation/insulation systems must form a barrier between these circuits and any user-accessible circuitry according to safety standard requirements.

REPEATED HIGH-VOLTAGE ISOLATION TESTING

It is well known that repeated high-voltage isolation testing of a barrier component can actually degrade isolation capability, to a lesser or greater degree depending on materials, construction and environment. The NTE series has toroidal isolation transformers, with no additional insulation between primary and secondary windings of enameled wire. While parts can be expected to withstand several times the stated test voltage, the isolation capability does depend on the wire insulation. Any material, including this enamel (typically polyurethane) is susceptible to eventual chemical degradation when subject to very high applied voltages thus implying that the number of tests should be strictly limited. We therefore strongly advise against repeated high voltage isolation testing, but if it is absolutely required, that the voltage be reduced by 20% from specified test voltage.

This consideration equally applies to agency recognized parts rated for better than functional isolation where the wire enamel insulation is always supplemented by a further insulation system of physical spacing or barriers.

TEMPERATURE DERATING GRAPH

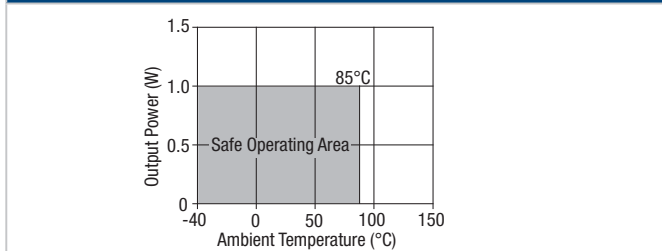

1. 12V input types have typically 3% less load regulation change.

TOLERANCE ENVELOPES

3.3V output types.

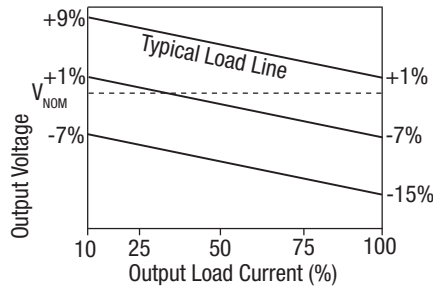

All other types.

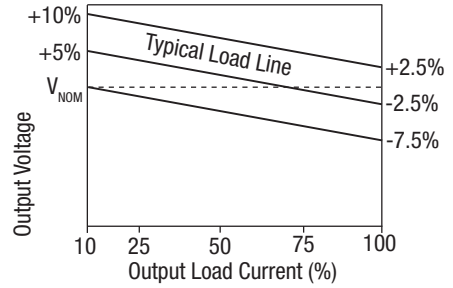

The voltage tolerance envelope shows typical load regulation characteristics for this product series. The tolerance envelope is the maximum output voltage variation due to changes in output loading.

RoHS COMPLIANCE, MSL AND PSL INFORMATION



This series is compatible with RoHS soldering systems and is also backward compatible with Sn/Pb soldering systems. The NTE series has a process, moisture, and reflow sensitivity classification of MSL1 PSL R7F as defined in J-STD-020 and J-STD-075. This translates to: MSL1 = unlimited floor life, PSL R7F = Peak reflow temperature 245°C with a limitation on the time above liquidus (217°C) which for this series is 60sec max. The pin termination finish on this product series is Gold with a plating thickness of 0.05 microns minimum.

For further information please visit www.murata-ps.com/rohs

APPLICATION NOTES

Minimum load

The minimum load to meet datasheet specification is 10% of the full rated load across the specified input voltage range. Lower than 10% minimum loading will result in an increase in output voltage, which may rise to typically double the specified output voltage if the output load falls to less than 5%.

Capacitive loading and start up

Typical start up times for this series, with a typical input voltage rise time of 2.2µs and output capacitance of 10µF, are shown in the table below. The product series will start into a capacitance of 47µF with an increased start time, however, the maximum recommended output capacitance is 10µF.

	Start-up time µs		Start-up time µs
NTE0303MC	437	NTE0506MC	7200
NTE0305MC	1359	NTE0509MC	3146
NTE0309MC	3435	NTE0512MC	4960
NTE0312MC	6590	NTE0515MC	7740
NTE0315MC	7625	NTE1205MC	895
NTE0503MC	533	NTE1209MC	2150
NTE0505MC	1368	NTE1212MC	3640
NTE0505MEC	721	NTE1215MC	7180

Typical Start-Up Wave Form

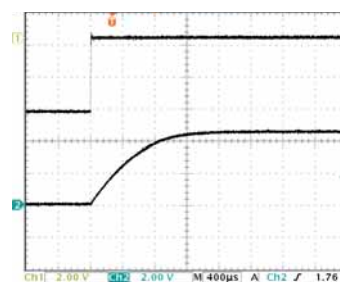

APPLICATION NOTES (continued)

Output Ripple Reduction

By using the values of inductance and capacitance stated, the output ripple at the rated load is lowered to 5mV p-p max.

Component selection

Capacitor: It is required that the ESR (Equivalent Series Resistance) should be as low as possible, ceramic types are recommended. The voltage rating should be at least twice (except for 15V output), the rated output voltage of the DC/DC converter.

Inductor: The rated current of the inductor should not be less than that of the output of the DC/DC converter. At the rated current, the DC resistance of the inductor should be such that the voltage drop across the inductor is <2% of the rated voltage of the DC/DC converter. The SRF (Self Resonant Frequency) should be >20MHz.

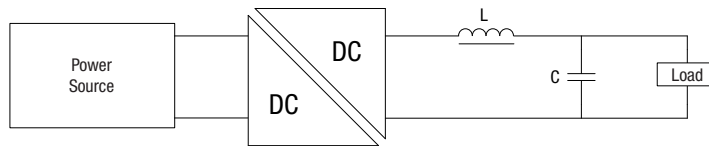

	Inductor			Capacitor
	L, μ H	SMD	Through Hole	C, μ F
NTE0303MC	10	82103C	11R103C	4.7
NTE0305MC	47	82473C	11R103C	4.7
NTE0309MC	22	82223C	11R223C	2.2
NTE0312MC	10	82103C	11R103C	1
NTE0315MC	47	82473C	11R473C	1
NTE0503MC	10	82103C	11R103C	4.7
NTE0505MC	47	82473C	11R473C	4.7
NTE0505MEC	47	82473C	11R473C	4.7
NTE0506MC	10	82103C	11R103C	4.7
NTE0509MC	22	82223C	11R223C	2.2
NTE0512MC	47	82473C	11R473C	1
NTE0515MC	47	82473C	11R473C	1
NTE1205MC	47	82473C	11R473C	4.7
NTE1209MC	22	82223C	11R223C	2.2
NTE1212MC	47	82473C	11R473C	1
NTE1215MC	47	82473C	11R473C	1

PACKAGE SPECIFICATIONS

MECHANICAL DIMENSIONS

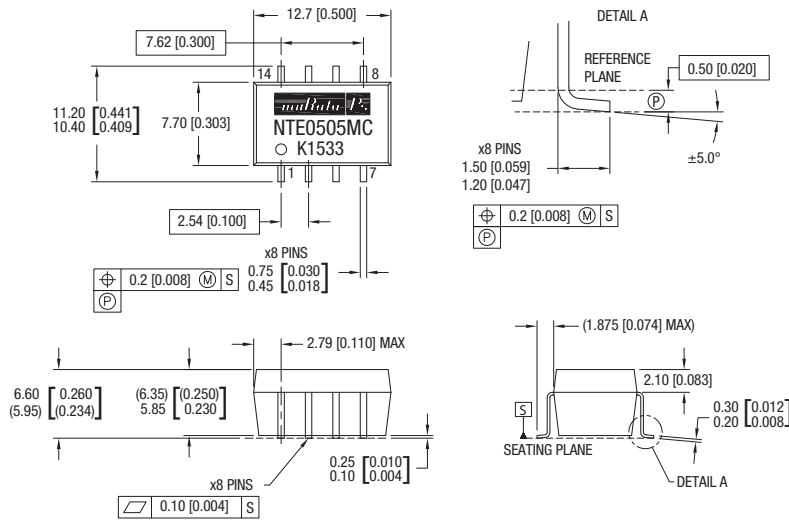

All dimensions in mm ± 0.25 mm (inches ± 0.01). All pins on a 2.54 (0.1) pitch and within ± 0.25 (0.01) of true position. Weight: 1.21g

PIN CONNECTIONS

Pin	Function
1	-V _{IN}
3	+V _{IN}
5	NA
7	-V _{OUT}
8	+V _{OUT}
10	NA
12	NA
14	NA

NA - Not available for electrical connection.

RECOMMENDED FOOTPRINT DETAILS

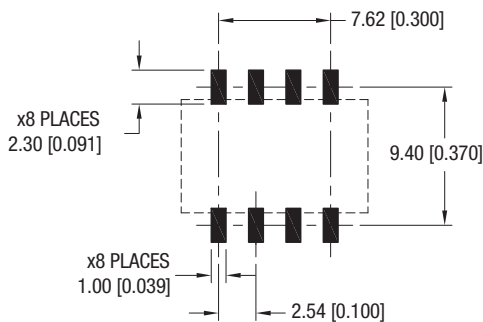

All pins on a 2.54mm pitch. Unless otherwise stated all dimensions in mm (inches) ± 0.5 mm.

TUBE OUTLINE DIMENSIONS

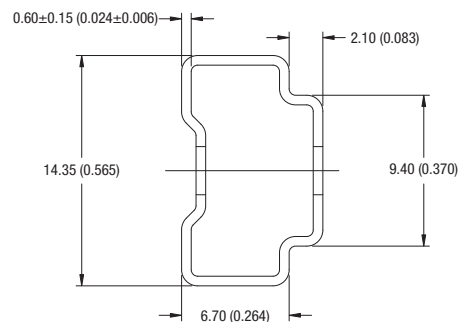

Unless otherwise stated all dimensions in mm ± 0.5 mm (inches ± 0.02). Tube length : 475 \pm 2.0 (18.70 \pm 0.07).

Tube Quantity : 35

TAPE & REEL SPECIFICATIONS

REEL OUTLINE DIMENSIONS

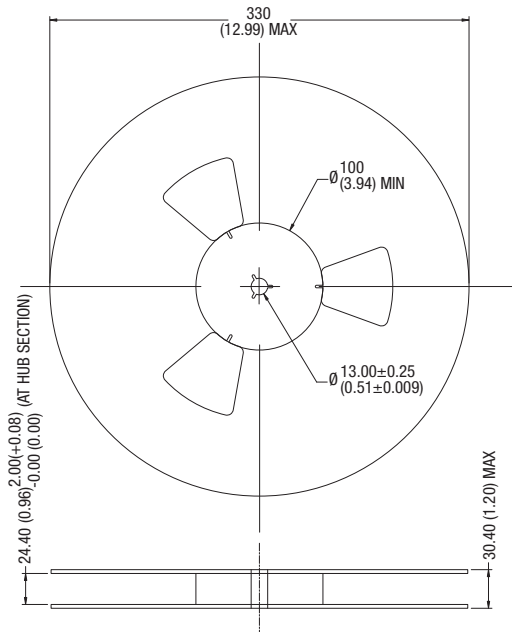

TAPE OUTLINE DIMENSIONS

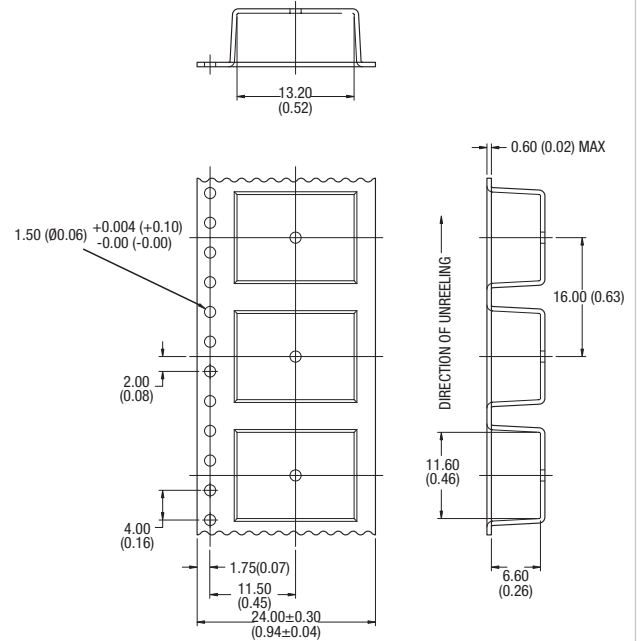

REEL PACKAGING DETAILS

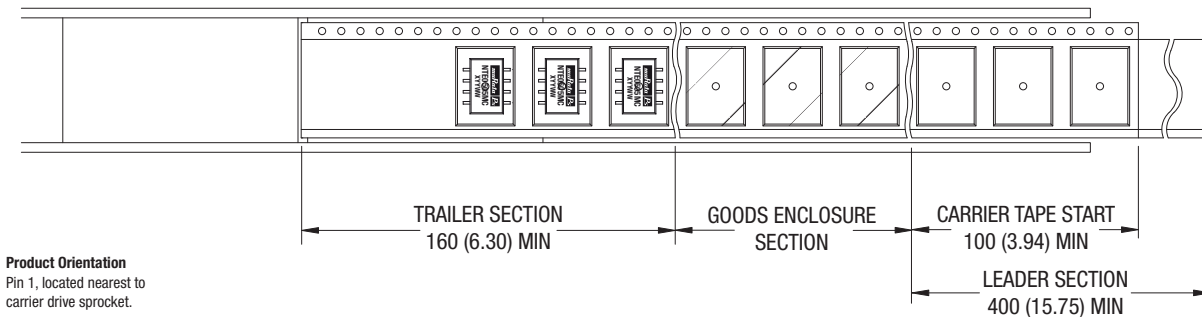

Product Orientation
Pin 1, located nearest to carrier drive sprocket.

Reel Quantity : 500

Murata Power Solutions, Inc.
11 Cabot Boulevard, Mansfield, MA 02048-1151 U.S.A.
ISO 9001 and 14001 REGISTERED



This product is subject to the following **operating requirements** and the **Life and Safety Critical Application Sales Policy**:
Refer to: <http://www.murata-ps.com/requirements/>

Murata Power Solutions, Inc. makes no representation that the use of its products in the circuits described herein, or the use of other technical information contained herein, will not infringe upon existing or future patent rights. The descriptions contained herein do not imply the granting of licenses to make, use, or sell equipment constructed in accordance therewith. Specifications are subject to change without notice. © 2015 Murata Power Solutions, Inc.