







## 600 W Surface Mount Transient Voltage Suppressor

<p><b>DO-214AA (SMB)</b></p> 	<table style="width: 100%; border: none;"> <tr> <td style="text-align: center;"><b>Voltage</b></td> <td style="text-align: center;"><b>Power</b></td> </tr> <tr> <td style="text-align: center;">6.8 V to 540 V (Uni) 6.8 V to 260 V (Bid)</td> <td style="text-align: center;">600 W /ms</td> </tr> </table> <div style="text-align: center; margin-top: 10px;">  </div>	<b>Voltage</b>	<b>Power</b>	6.8 V to 540 V (Uni) 6.8 V to 260 V (Bid)	600 W /ms
<b>Voltage</b>	<b>Power</b>				
6.8 V to 540 V (Uni) 6.8 V to 260 V (Bid)	600 W /ms				
	<p><b>FEATURES</b></p> <ul style="list-style-type: none"> <li>Low profile package</li> <li>Ideal for automated placement</li> <li>600 W peak pulse power capability with a 10/1000 <math>\mu</math>s waveform, repetitive rate (duty cycle): 0.01 %</li> <li>Excellent clamping capability</li> <li>Very fast response time</li> <li>Low incremental surge resistance</li> <li>Available in uni-directional and bi-directional</li> <li>Solder dip 260°C, 10s</li> <li>AEC-Q101 qualified</li> <li>Component in accordance to RoHS 2011/65/EU and WEEE 2002/96/EC</li> <li>Meets MSL level 1, per J-STD-020, LF maximum peak of 260° C</li> </ul> <div style="float: right; text-align: center;">       <b>RoHS COMPLIANT</b>   </div>				
	<p><b>MECHANICAL DATA</b></p> <ul style="list-style-type: none"> <li><b>Case:</b> DO-214AA (SMB). Epoxy meets UL 94V-0 flammability rating.</li> <li><b>Polarity:</b> For unidirectional types color band denotes cathode end. No marking on bidirectional types.</li> <li><b>Terminals:</b> Matte tin plated leads, solderable per MIL-STD-750 Method 2026, J-STD-002 and JESD22-B102. Consumer grade, meets JESD 201 class 1A whisker test. HE3 suffix for high reliability grade, meets JESD 201 class 2 whisker test.</li> </ul>				
	<p><b>TYPICAL APPLICATIONS</b></p> <p>Used in sensitive electronics protection against voltage transients induced by inductive load switching and lighting on ICs, MOSFET, signal lines of sensor units for consumer, computer, industrial, automotive and telecommunication.</p>				

### Maximun Ratings and Electrical Characteristics at 25°C

$P_{PPM}$	Peak Pulse Power Dissipation with 10/1000 $\mu$ s exponential pulse	600 W
$I_{FSM}$	Peak Forward Surge Current 8.3 ms. (Note 1) (Jedec Method) (Note 2)	100 A
$V_F$	Max. forward voltage drop at $I_F = 50$ A (Note 1)	3.5 V
$T_J - T_{STG}$	Operating Junction and Storage Temperature Range	- 65 to + 150 °C

Notes: 1. Only for Unidirectional  
2. Mounted on 0.31 x 0.31" (8.0 x 8.0 mm) copper pads to each terminal

## 600 W Surface Mount Transient Voltage Suppressor

### Ordering information

PREFERRED P/N	PACKAGE CODE	DELIVERY MODE	BASE QUANTITY	UNIT WEIGHT (g)
P6SMB33A TRTB	TRTB	13" diameter tape and reel	3,200	0.082
P6SMB33A TRTS	TRTS	7" diameter tape and reel	750	0.082
P6SMB33A HE3 TRTB	TRTB	13" diameter tape and reel	3,200	0.082
P6SMB33A HE3 TRTS	TRTS	7" diameter tape and reel	750	0.082
P6SMB33A HF TRTB	TRTB	13" diameter tape and reel	3,200	0.082
P6SMB33CA TRTB	TRTB	13" diameter tape and reel	3,200	0.082
P6SMB33CA TRTS	TRTS	7" diameter tape and reel	750	0.082
P6SMB33CA HE3 TRTB	TRTB	13" diameter tape and reel	3,200	0.082
P6SMB33CA HE3 TRTS	TRTS	7" diameter tape and reel	750	0.082
P6SMB33CA HF TRTB	TRTB	13" diameter tape and reel	3,200	0.082

### Package Outline Dimensions: (mm) DO-214AA (SMB)

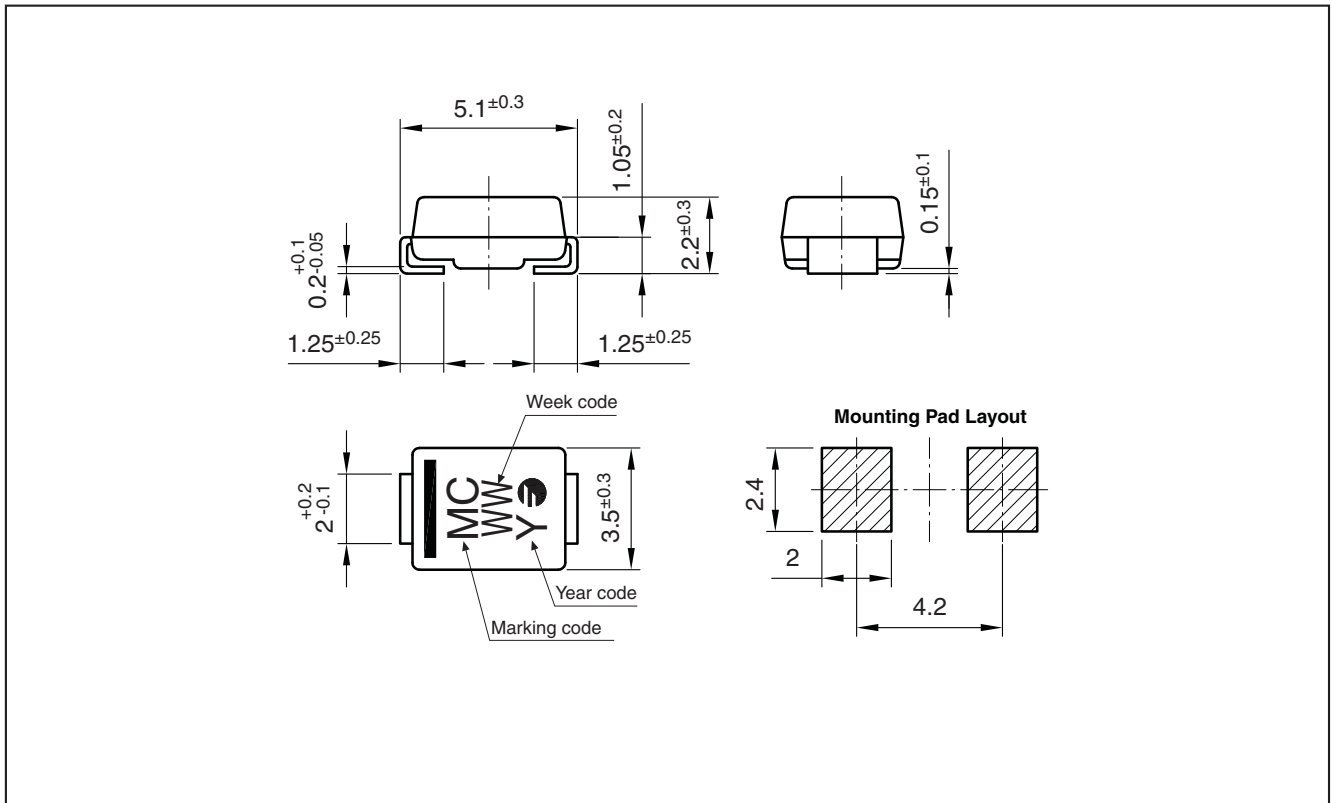

## 600 W Surface Mount Transient Voltage Suppressor

Type		Maximum Reverse Leakage Current		(1) Breakdown Voltage			$I_R$	Max. Clamping Voltage	
Unidirectional	Marking Code	$I_{RM}$	at $V_{RM}$	$V_{BR}$ at				$V_{CL}$ at $I_{pp}$	max. 1ms. Expo.
		( $\mu A$ )	(V)	Min.	Nom.	Max.	(mA)	(V)	(A)
P6SMB6V8	KD	1000	5.50	6.12	6.8	7.48	10	10.8	56
P6SMB6V8A	KE	1000	5.80	6.45	6.8	7.14	10	10.5	57
P6SMB7V5	KF	500	6.05	6.75	7.5	8.25	10	11.7	51
P6SMB7V5A	KG	500	6.40	7.13	7.5	7.88	10	11.3	53
P6SMB8V2	KH	200	6.63	7.38	8.2	9.02	10	12.5	48
P6SMB8V2A	KK	200	7.02	7.79	8.2	8.61	10	12.1	50
P6SMB9V1	KL	50	7.37	8.19	9.1	10.0	1	13.8	44
P6SMB9V1A	KM	50	7.78	8.65	9.1	9.55	1	13.4	45
P6SMB10	KN	10	8.10	9.00	10	11.0	1	15.0	40
P6SMB10A	KP	10	8.55	9.50	10	10.5	1	14.5	41
P6SMB11	KQ	5	8.92	9.90	11	12.1	1	16.2	37
P6SMB11A	KR	5	9.40	10.5	11	11.6	1	15.6	38
P6SMB12	KS	5	9.72	10.8	12	13.2	1	17.3	35
P6SMB12A	KT	5	10.2	11.4	12	12.6	1	16.7	36
P6SMB13	KU	5	10.5	11.7	13	14.3	1	19.0	32
P6SMB13A	KV	5	11.1	12.4	13	13.7	1	18.2	33
P6SMB15	KW	1	12.1	13.5	15	16.5	1	22.0	27
P6SMB15A	KX	1	12.8	14.3	15	15.8	1	21.2	28
P6SMB16	KY	1	12.9	14.4	16	17.6	1	23.5	26
P6SMB16A	KZ	1	13.6	15.2	16	16.8	1	22.5	27
P6SMB18	LD	1	14.5	16.2	18	19.8	1	26.5	23
P6SMB18A	LE	1	15.3	17.1	18	18.9	1	25.5	24
P6SMB20	LF	1	16.2	18.0	20	22.0	1	29.1	21
P6SMB20A	LG	1	17.1	19.0	20	21.0	1	27.7	22
P6SMB22	LH	1	17.8	19.8	22	24.2	1	31.9	19
P6SMB22A	LK	1	18.8	20.9	22	23.1	1	30.6	20
P6SMB24	LL	1	19.4	21.6	24	26.4	1	34.7	17
P6SMB24A	LM	1	20.5	22.8	24	25.2	1	33.2	18
P6SMB27	LN	1	21.8	24.3	27	29.7	1	39.1	15
P6SMB27A	LP	1	23.1	25.7	27	28.4	1	37.5	16
P6SMB30	LQ	1	24.3	27.0	30	33.0	1	43.5	14
P6SMB30A	LR	1	25.6	28.5	30	31.5	1	41.4	14.4
P6SMB33	LS	1	26.8	29.7	33	36.3	1	47.7	12.6
P6SMB33A	LT	1	28.2	31.4	33	34.7	1	45.7	13.2
P6SMB36	LU	1	29.1	32.4	36	39.6	1	52.0	11.6
P6SMB36A	LV	1	30.8	34.2	36	37.8	1	49.9	12
P6SMB39	LW	1	31.6	35.1	39	42.9	1	56.4	10.6
P6SMB39A	LX	1	33.3	37.1	39	41.0	1	53.9	11.2
P6SMB43	LY	1	34.8	38.7	43	47.3	1	61.9	9.6
P6SMB43A	LZ	1	36.8	40.9	43	45.2	1	59.3	10.1
P6SMB47	MD	1	38.1	42.3	47	51.7	1	67.8	8.9
P6SMB47A	ME	1	40.2	44.7	47	49.4	1	64.8	9.3

(1) Tested with pulses.  
Pulse test:  $t_p \leq 50$  ms;  $\delta < 2\%$

## 600 W Surface Mount Transient Voltage Suppressor

Type		Maximum Reverse Leakage Current $I_{RM}$ at $V_{RM}$		(1) Breakdown Voltage $V_{BR}$ at $I_R$				Max. Clamping Voltage $V_{CL}$ at $I_{pp}$ max. 1ms. Expo.	
Unidirectional	Marking Code	( $\mu A$ )	(V)	Min.	Nom.	Max.	(mA)	(V)	(A)
P6SMB51	MF	1	41.3	45.9	51	56.1	1	73.5	8.2
P6SMB51A	MG	1	43.6	48.5	51	53.6	1	70.1	8.6
P6SMB56	MH	1	45.4	50.4	56	61.6	1	80.5	7.4
P6SMB56A	MK	1	47.8	53.2	56	58.8	1	77.0	7.8
P6SMB62	ML	1	50.2	55.8	62	68.2	1	89.0	6.8
P6SMB62A	MM	1	53.0	58.9	62	65.1	1	85.0	7.1
P6SMB68	MN	1	55.1	61.2	68	74.8	1	98.0	6.1
P6SMB68A	MP	1	58.1	64.6	68	71.4	1	92.0	6.5
P6SMB75	MQ	1	60.7	67.5	75	82.5	1	108	5.5
P6SMB75A	MR	1	64.1	71.3	75	78.8	1	103	5.8
P6SMB82	MS	1	66.4	73.8	82	90.2	1	118	5.1
P6SMB82A	MT	1	70.1	77.9	82	86.1	1	113	5.3
P6SMB91	MU	1	73.7	81.9	91	100	1	131	4.5
P6SMB91A	MV	1	77.8	86.5	91	95.5	1	125	4.8
P6SMB100	MW	1	81.0	90.00	100	110	1	144	4.2
P6SMB100A	MX	1	85.5	95.0	100	105	1	137	4.4
P6SMB110	MY	1	89.2	99.0	110	121	1	158	3.8
P6SMB110A	MZ	1	94.0	105	110	116	1	152	4.0
P6SMB120	ND	1	97.2	108	120	132	1	173	3.5
P6SMB120A	NE	1	102	114	120	126	1	165	3.6
P6SMB130	NF	1	105	117	130	143	1	187	3.2
P6SMB130A	NG	1	111	124	130	137	1	179	3.3
P6SMB150	NH	1	121	135	150	165	1	215	2.8
P6SMB150A	NK	1	128	143	150	158	1	207	2.9
P6SMB160	NL	1	130	144	160	176	1	230	2.6
P6SMB160A	NM	1	136	152	160	168	1	219	2.7
P6SMB170	NN	1	138	153	170	187	1	244	2.5
P6SMB170A	NP	1	145	162	170	179	1	234	2.6
P6SMB180	NQ	1	146	162	180	198	1	258	2.3
P6SMB180A	NR	1	154	171	180	189	1	246	2.4
P6SMB200	NS	1	162	180	200	220	1	287	2.1
P6SMB200A	NT	1	171	190	200	210	1	274	2.2
P6SMB220	NU	1	175	198	220	242	1	344	1.75
P6SMB220A	NV	1	185	209	220	231	1	328	1.83
P6SMB250	NW	1	202	225	250	275	1	360	1.67
P6SMB250A	NX	1	214	237	250	263	1	344	1.75
P6SMB300	NJ	1	243	270	300	330	1	434	1.39
P6SMB300A	NZ	1	256	285	300	315	1	414	1.45
P6SMB350A	YW	1	300	333	350	368	1	482	1.24
P6SMB400A	YX	1	342	380	400	420	1	548	1.10
P6SMB440A	YY	1	376	418	440	462	1	602	1.0
P6SMB480A	KA	1	408	456	480	504	1	658	0.91
P6SMB510A	YZ	1	434	485	510	535	1	698	0.86
P6SMB540A	KB	1	459	513	540	567	1	740	0.81

(1) Tested with pulses.  
Pulse test:  $t_p \leq 50$  ms;  $\delta < 2\%$

## 600 W Surface Mount Transient Voltage Suppressor

Type		Maximum Reverse Leakage Current		(1) Breakdown Voltage				Max. Clamping Voltage	
		$I_{RM}$	at $V_{RM}$	$V_{BR}$ at $I_R$			$V_{CL}$	at $I_{pp}$	
Bidirectional	Marking Code	( $\mu A$ )	(V)	Min.	Nom.	Max.	(mA)	(V)	(A)
P6SMB6V8C	PD	1000	5.50	6.12	6.8	7.48	10	10.8	56
P6SMB6V8CA	PE	1000	5.80	6.45	6.8	7.14	10	10.5	57
P6SMB7V5C	PF	500	6.05	6.75	7.5	8.25	10	11.7	51
P6SMB7V5CA	PG	500	6.40	7.13	7.5	7.88	10	11.3	53
P6SMB8V2C	PH	200	6.63	7.38	8.2	9.02	10	12.5	48
P6SMB8V2CA	PK	200	7.02	7.79	8.2	8.61	10	12.1	50
P6SMB9V1C	PL	50	7.37	8.19	9.1	10.0	1	13.8	44
P6SMB9V1CA	PM	50	7.78	8.65	9.1	9.55	1	13.4	45
P6SMB10C	PN	10	8.10	9.00	10	11.0	1	15.0	40
P6SMB10CA	PP	10	8.55	9.50	10	10.5	1	14.5	41
P6SMB11C	PQ	5	8.92	9.90	11	12.1	1	16.2	37
P6SMB11CA	PR	5	9.40	10.5	11	11.6	1	15.6	38
P6SMB12C	PS	5	9.72	10.8	12	13.2	1	17.3	35
P6SMB12CA	PT	5	10.2	11.4	12	12.6	1	16.7	36
P6SMB13C	PU	5	10.5	11.7	13	14.3	1	19.0	32
P6SMB13CA	PV	5	11.1	12.4	13	13.7	1	18.2	33
P6SMB15C	PW	1	12.1	13.5	15	16.5	1	22.0	27
P6SMB15CA	PX	1	12.8	14.3	15	15.8	1	21.2	28
P6SMB16C	PY	1	12.9	14.4	16	17.6	1	23.5	26
P6SMB16CA	PZ	1	13.6	15.2	16	16.8	1	22.5	27
P6SMB18C	QD	1	14.5	16.2	18	19.8	1	26.5	23
P6SMB18CA	QE	1	15.3	17.1	18	18.9	1	25.5	24
P6SMB20C	QF	1	16.2	18.0	20	22.0	1	29.1	21
P6SMB20CA	QG	1	17.1	19.0	20	21.0	1	27.7	22
P6SMB22C	QH	1	17.8	19.8	22	24.2	1	31.9	19
P6SMB22CA	QK	1	18.8	20.9	22	23.1	1	30.6	20
P6SMB24C	QL	1	19.4	21.6	24	26.4	1	34.7	17
P6SMB24CA	QM	1	20.5	22.8	24	25.2	1	33.2	18
P6SMB27C	QN	1	21.8	24.3	27	29.7	1	39.1	15
P6SMB27CA	QP	1	23.1	25.7	27	28.4	1	37.5	16
P6SMB30C	QQ	1	24.3	27.0	30	33.0	1	43.5	14
P6SMB30CA	QR	1	25.6	28.5	30	31.5	1	41.4	14.4
P6SMB33C	QS	1	26.8	29.7	33	36.3	1	47.7	12.6
P6SMB33CA	QT	1	28.2	31.4	33	34.7	1	45.7	13.2
P6SMB36C	QU	1	29.1	32.4	36	39.6	1	52.0	11.6
P6SMB36CA	QV	1	30.8	34.2	36	37.8	1	49.9	12
P6SMB39C	QW	1	31.6	35.1	39	42.9	1	56.4	10.6
P6SMB39CA	QX	1	33.3	37.1	39	41.0	1	53.9	11.2

(1) Tested with pulses.  
Pulse test:  $t_p \leq 50$  ms;  $\delta < 2\%$

## 600 W Surface Mount Transient Voltage Suppressor

Type		Maximum Reverse Leakage Current $I_{RM}$ at $V_{RM}$		(1) Breakdown Voltage $V_{BR}$ at $I_R$ (V)				Max. Clamping Voltage $V_{CL}$ at $I_{pp}$ max. 1ms. Expo.	
Bidirectional	Marking Code	( $\mu A$ )	(V)	Min.	Nom.	Max.	(mA)	(V)	(A)
P6SMB43C	QY	1	34.8	38.7	43	47.3	1	61.9	9.6
P6SMB43CA	QZ	1	36.8	40.9	43	45.2	1	59.3	10.1
P6SMB47C	TD	1	38.1	42.3	47	51.7	1	67.8	8.9
P6SMB47CA	TE	1	40.2	44.7	47	49.4	1	64.8	9.3
P6SMB51C	TF	1	41.3	45.9	51	56.1	1	73.5	8.2
P6SMB51CA	TG	1	43.6	48.5	51	53.6	1	70.1	8.6
P6SMB56C	TH	1	45.4	50.4	56	61.6	1	80.5	7.4
P6SMB56CA	TK	1	47.8	53.2	56	58.8	1	77.0	7.8
P6SMB62C	TL	1	50.2	55.8	62	68.2	1	89.0	6.8
P6SMB62CA	TM	1	53.0	58.9	62	65.1	1	85.0	7.1
P6SMB68C	TN	1	55.1	61.2	68	74.8	1	98.0	6.1
P6SMB68CA	TP	1	58.1	64.6	68	71.4	1	92.0	6.5
P6SMB75C	TQ	1	60.7	67.5	75	82.5	1	108	5.5
P6SMB75CA	TR	1	64.1	71.3	75	78.8	1	103	5.8
P6SMB82C	TS	1	66.4	73.8	82	90.2	1	118	5.1
P6SMB82CA	TT	1	70.1	77.9	82	86.1	1	113	5.3
P6SMB91C	TU	1	73.7	81.9	91	100	1	131	4.5
P6SMB91CA	TV	1	77.8	86.5	91	95.5	1	125	4.8
P6SMB100C	TW	1	81.0	90.00	100	110	1	144	4.2
P6SMB100CA	TX	1	85.5	95.0	100	105	1	137	4.4
P6SMB110C	TY	1	89.2	99.0	110	121	1	158	3.8
P6SMB110CA	TZ	1	94.0	105	110	116	1	152	4.0
P6SMB120C	VD	1	97.2	108	120	132	1	173	3.5
P6SMB120CA	VE	1	102	114	120	126	1	165	3.6
P6SMB130C	VF	1	105	117	130	143	1	187	3.2
P6SMB130CA	VG	1	111	124	130	137	1	179	3.3
P6SMB150C	VH	1	121	135	150	165	1	215	2.8
P6SMB150CA	VK	1	128	143	150	158	1	207	2.9
P6SMB160C	VL	1	130	144	160	176	1	230	2.6
P6SMB160CA	VM	1	136	152	160	168	1	219	2.7
P6SMB170C	VN	1	138	153	170	187	1	244	2.5
P6SMB170CA	VP	1	145	162	170	179	1	234	2.6
P6SMB180C	VQ	1	146	162	180	198	1	258	2.3
P6SMB180CA	VR	1	154	171	180	189	1	246	2.4
P6SMB200C	VS	1	162	180	200	220	1	287	2.1
P6SMB200CA	VT	1	171	190	200	210	1	274	2.2
P6SMB220C	VU	1	175	198	220	242	1	344	1.75
P6SMB220CA	VV	1	185	209	220	231	1	328	1.83
P6SMB250C	VW	1	202	225	250	275	1	360	1.67
P6SMB250CA	VX	1	214	237	250	263	1	344	1.75
P6SMB260C	VY	1	220	240	260	285	1	372	1.61
P6SMB260CA	KI	1	232	247	260	273	1	360	1.67

(1) Tested with pulses.  
Pulse test:  $t_p \leq 50$  ms;  $\delta < 2\%$

## 600 W Surface Mount Transient Voltage Suppressor

Ratings and Characteristics (Ta 25 °C unless otherwise noted)

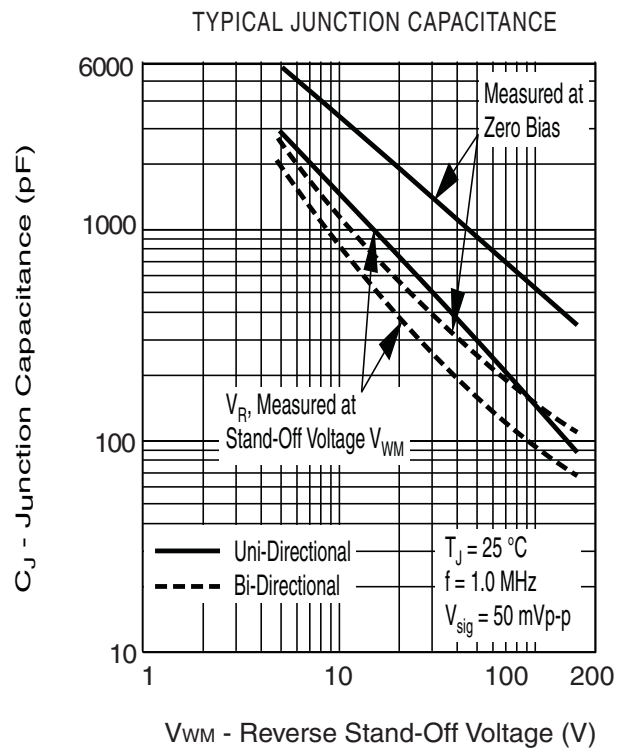
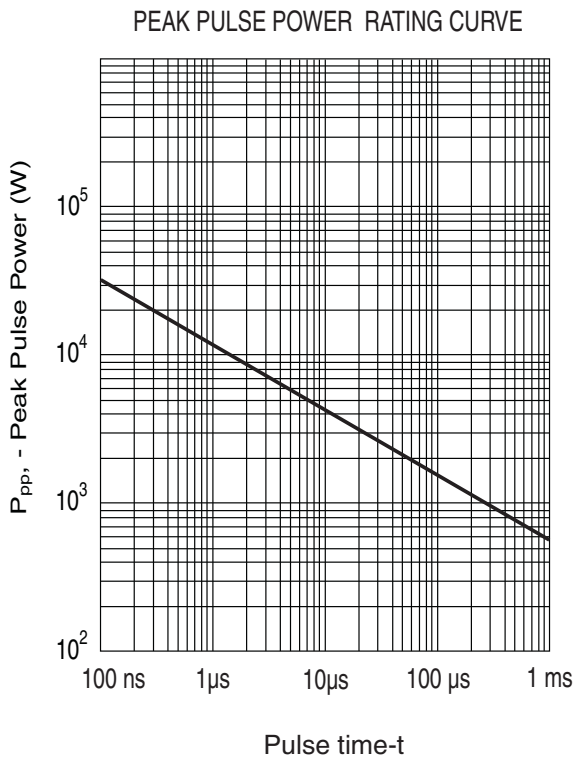
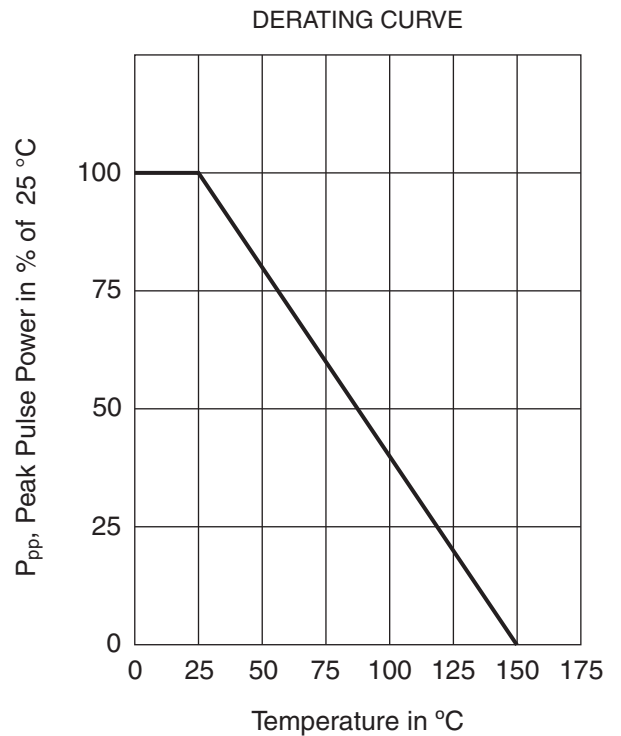
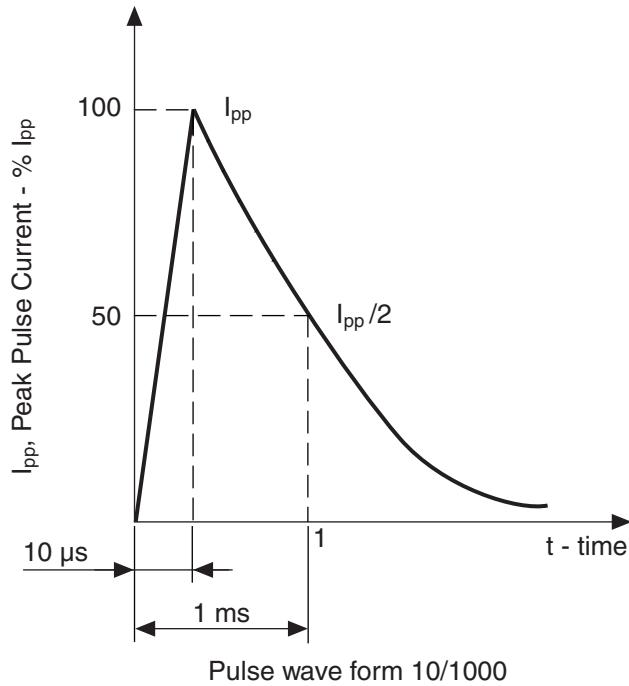



**600 W Surface Mount Transient Voltage Suppressor**

## Disclaimer

All product, product specifications and data are subject to change without notice to improve reliability, function or design or otherwise.

Fagor Electrónica, S.Coop., its affiliates, agents, and employees, and all persons acting on its or their behalf (collectively, "Fagor"), disclaim any and all liability for any errors, inaccuracies or incompleteness contained in any datasheet or in any other disclosure relating to any product.

Fagor makes no warranty, representation or guarantee regarding the suitability of the products for any particular purpose or the continuing production of any product. To the maximum extent permitted by applicable law, Fagor disclaims (i) any and all liability arising out of the application or use of any product, (ii) any and all liability, including without limitation special, consequential or incidental damages, and (iii) any and all implied warranties, including warranties of fitness for particular purpose, non-infringement and merchantability.

Statements regarding the suitability of products for certain types of applications are based on Fagor's knowledge of typical requirements that are often placed on Fagor products in generic applications. Such statements are not binding statements about the suitability of products for a particular application. It is the customer's responsibility to validate that a particular product with the properties described in the product specification is suitable for use in a particular application. Parameters provided in datasheets and/or specifications may vary in different applications and performance may vary over time. All operating parameters, including typical parameters, must be validated for each customer application by the customer's technical experts. Product specifications do not expand or otherwise modify Fagor's terms and conditions of purchase, including but not limited to the warranty expressed therein.

Except as expressly indicated in writing, Fagor products are not designed for use in medical, life-saving, or life-sustaining applications or for any other application in which the failure of the Fagor product could result in personal injury or death. Customers using or selling Fagor products not expressly indicated for use in such applications do so at their own risk and agree to fully indemnify and hold Fagor and its distributors harmless from and against any and all claims, liabilities, expenses and damages arising or resulting in connection with such use or sale, including attorneys fees, even if such claim alleges that Fagor or its distributor was negligent regarding the design or manufacture of the part. Please contact authorized Fagor personnel to obtain written terms and conditions regarding products designed for such applications.

No license, express or implied, by estoppel or otherwise, to any intellectual property rights is granted by this document or by any conduct of Fagor, Product names and markings noted herein may be trademarks of their respective owners.