

POWER TRANSISTORS

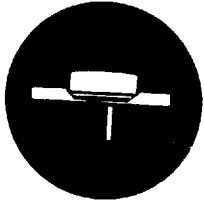

TO-3

TYPE NO.	PT @ 25°C Watts	MAXIMUM RATINGS				hFE		@		Sat Voltages		Test Conditions		
		BVCBO	BVCEO	BVEBO	Ic	MIN	MAX	Ic	VCE	VCE	VBE	Ic	Ib	IEBO
		V	V	V	A									
2N1069	50	60	45	9	4	10	50	1.5	4	3	4.5	1.5	.3	.100
2N1070	50	60	45	9	4	10	50	1.5	4	1	4.5	1.5	.3	.100
2N1487	75	60	40	10	6	15	45	1.5	4	3	3.5	1.5	.3	.025
2N1488	75	100	55	10	6	15	45	1.5	4	3	3.5	1.5	.3	.025
2N1489	75	60	40	10	6	25	75	1.5	4	1	2.5	1.5	.1	.025
2N1490	75	100	55	10	6	27	75	1.5	4	1	2.5	1.5	.1	.025
2N1702	75	60	40	6	5	15	60	.8	4	3.2	4	.8	.08	1
2N2305	75	60	40	6	6	15	60	.8	4	1.2	4	.6	.06	1
2N3232	115	80	60	6	7.5	18	55	3	10	2.5	3.5	3	.2	1
2N3233	115	110	100	6	7.5	18	55	3	10	2.5	3.5	3	.2	1
2N3234	115	160	160	6	7.5	18	55	3	10	2.5	3.5	3	.2	1
2N3235	115	65	55	7	15	20	70	4	4	1.1	1.8	4	.4	5
2N3236	150	90	90	7	15	17	60	5	4	1.1	1.8	5	.5	2
2N3237	200	90	75	7	20	12	36	10	8	2	3	10	1.35	5
2N3238	150	80	80	8	15	8.5	25	10	12	3	4	10	1.33	5
2N3239	150	80	80	8	15	8.5	25	10	10	1	2	10	1.33	5
2N3240	150	160	160	8	15	8.5	25	10	10	1	2	10	1.33	5
2N3667	150	50	50	7	15	15	60	8	3	1.6	2.4	8	.8	5
2N3713	150	80	60	7	10	25	75	1	2	1	1.5	5	.5	1
2N3714	150	100	80	7	10	25	75	1	2	1	1.5	5	.5	1
2N3715	150	80	60	7	10	50	150	1	2	.8	1.5	5	.5	1
2N3716	150	100	80	7	10	50	150	1	2	.8	1.5	5	.5	1
2N3863	117	70	50	7	7.5	30	60	3	2	1	2	3	.2	1
2N3864	117	110	90	7	7.5	30	90	3	2	1	2	3	.2	1
2N3865	117	160	150	7	7.5	30	90	3	2	1	2	3	.2	1
2N4913	88	40	40	5	5	25	100	2.5	2	1.5	1.5	5	1	1
2N4914	88	60	60	5	5	25	100	2.5	2	1.5	1.5	5	1	1
2N4915	88	80	80	5	5	25	100	2.5	2	1.5	1.5	5	1	1

CASE OUTLINES

TO-3

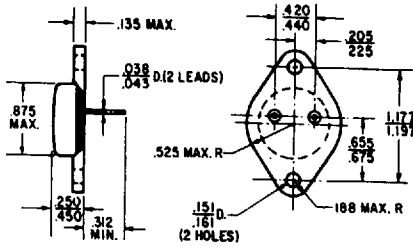

TO-57

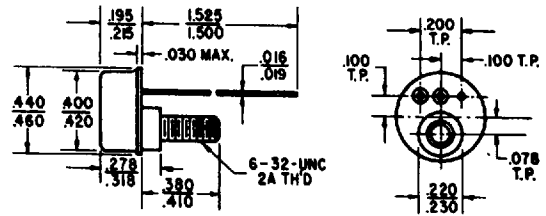

TO-8

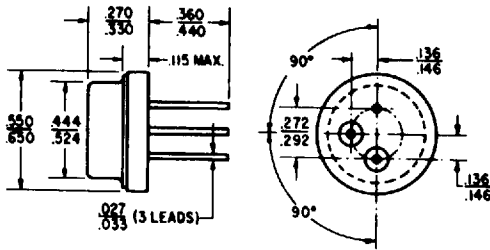

TO-59

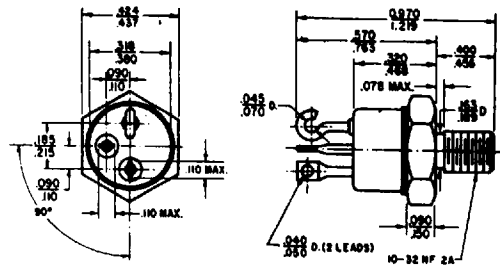

TO-5

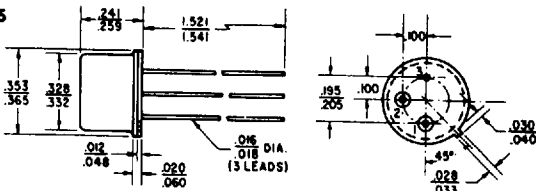

TO-81

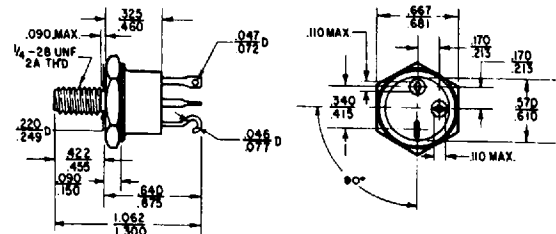

TO-36

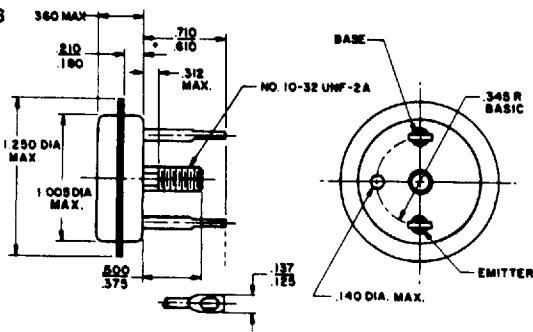

TO-63

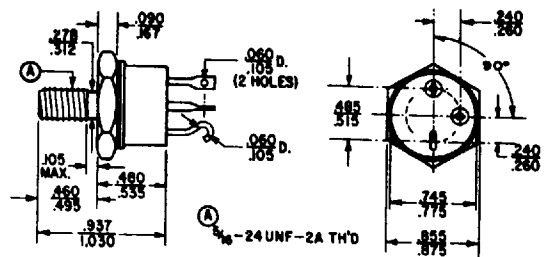

TO-53

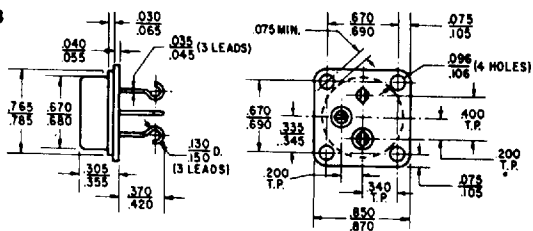

TO-82

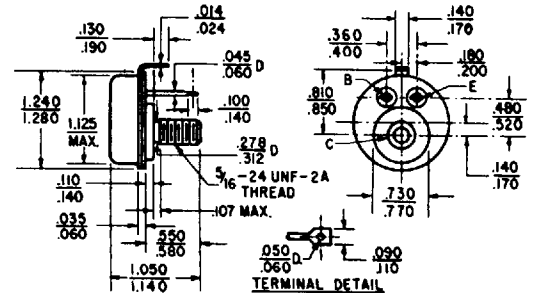

TO-114

