

## 4-20mA CURRENT TRANSMITTER with Sensor Excitation and Linearization

### FEATURES

- LOW UNADJUSTED ERROR
- TWO PRECISION CURRENT SOURCES: 800 $\mu$ A each
- LINEARIZATION
- 2- OR 3-WIRE RTD OPERATION
- LOW OFFSET DRIFT: 0.4 $\mu$ V/ $^{\circ}$ C
- LOW OUTPUT CURRENT NOISE: 30nA<sub>PP</sub>
- HIGH PSR: 110dB minimum
- HIGH CMR: 86dB minimum
- WIDE SUPPLY RANGE: 7.5V to 36V
- DIP-14 AND SO-14 PACKAGES

### DESCRIPTION

The XTR105 is a monolithic 4-20mA, 2-wire current transmitter with two precision current sources. It provides complete current excitation for platinum RTD temperature sensors and bridges, instrumentation amplifiers, and current output circuitry on a single integrated circuit.

Versatile linearization circuitry provides a 2nd-order correction to the RTD, typically achieving a 40:1 improvement in linearity.

Instrumentation amplifier gain can be configured for a wide range of temperature or pressure measurements. Total unadjusted error of the complete current transmitter is low enough to permit use without adjustment in many applications. This includes zero output current drift, span drift, and nonlinearity. The XTR105 operates on loop power-supply voltages down to 7.5V.

The XTR105 is available in DIP-14 and SO-14 surface-mount packages and is specified for the  $-40^{\circ}$ C to  $+85^{\circ}$ C industrial temperature range.

### APPLICATIONS

- INDUSTRIAL PROCESS CONTROL
- FACTORY AUTOMATION
- SCADA REMOTE DATA ACQUISITION
- REMOTE TEMPERATURE AND PRESSURE TRANSDUCERS

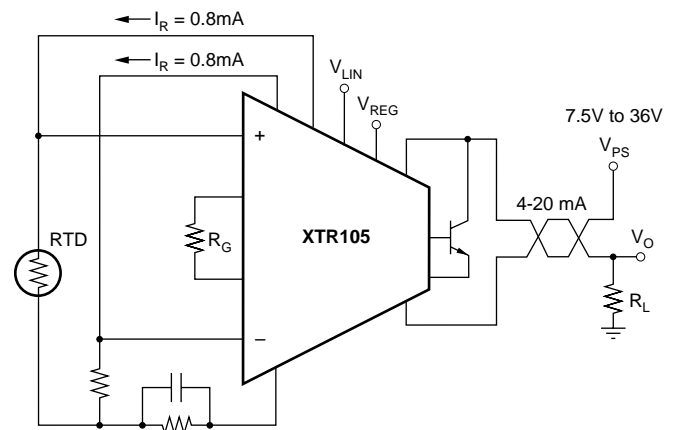
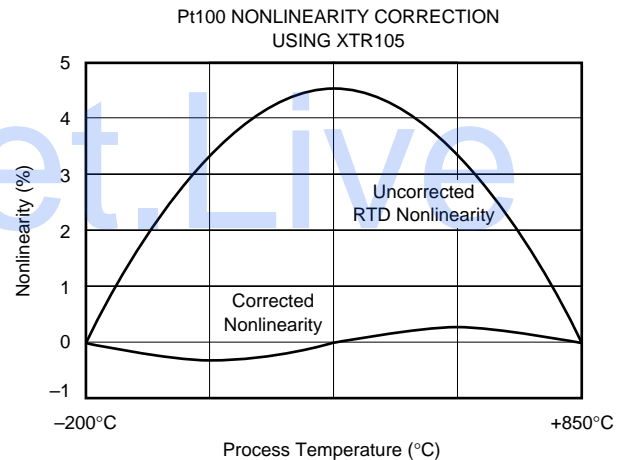

Please be aware that an important notice concerning availability, standard warranty, and use in critical applications of Texas Instruments semiconductor products and disclaimers thereto appears at the end of this data sheet.

All trademarks are the property of their respective owners.

## ABSOLUTE MAXIMUM RATINGS<sup>(1)</sup>

Power Supply, V+ (referenced to the I <sub>O</sub> pin)	40V
Input Voltage, V <sub>IN+</sub> , V <sub>IN-</sub> (referenced to the I <sub>O</sub> pin)	0V to V+
Storage Temperature Range	-55°C to +125°C
Lead Temperature (soldering, 10s)	+300°C
Output Current Limit	Continuous
Junction Temperature	+165°C

NOTE: (1) Stresses above those listed under "Absolute Maximum Ratings" may cause permanent damage to the device. Exposure to absolute maximum conditions for extended periods may affect device reliability.



## ELECTROSTATIC DISCHARGE SENSITIVITY

This integrated circuit can be damaged by ESD. Texas Instruments recommends that all integrated circuits be handled with appropriate precautions. Failure to observe proper handling and installation procedures can cause damage.

ESD damage can range from subtle performance degradation to complete device failure. Precision integrated circuits may be more susceptible to damage because very small parametric changes could cause the device not to meet its published specifications.

## PACKAGE/ORDERING INFORMATION<sup>(1)</sup>

PRODUCT	PACKAGE-LEAD	PACKAGE DESIGNATOR	SPECIFIED TEMPERATURE RANGE	PACKAGE MARKING	ORDERING NUMBER	TRANSPORT MEDIA, QUANTITY
XTR105	DIP-14	N	-40°C to +85°C	XTR105PA	XTR105PA	Rails, 25
"	"	"	"	XTR105P	XTR105P	Rails, 25
XTR105	SO-14 Surface-Mount	D	-40°C to +85°C	XTR105UA	XTR105UA	Rails, 58
"	"	"	"	XTR105UA	XTR105UA/2K5	Tape and Reel, 2500
XTR105	SO-14 Surface-Mount	D	-40°C to +85°C	XTR105U	XTR105U	Rails, 58
"	"	"	"	XTR105U	XTR105U/2K5	Tape and Reel, 2500

NOTE: (1) For the most current package and ordering information, see the Package Option Addendum located at the end of this data sheet.

## FUNCTIONAL BLOCK DIAGRAM



## PIN CONFIGURATION



# ELECTRICAL CHARACTERISTICS

At  $T_A = +25^\circ\text{C}$ ,  $V_+ = 24\text{V}$ , and TIP29C external transistor, unless otherwise noted.

PARAMETER	CONDITIONS	XTR105P, U			XTR105PA, UA			UNITS	
		MIN	TYP	MAX	MIN	TYP	MAX		
<b>OUTPUT</b> Output Current Equation Output Current, Specified Range Over-Scale Limit Under-Scale Limit	$I_{\text{REG}} = 0\text{V}$	$I_O = V_{\text{IN}} \cdot (40/R_G) + 4\text{mA}$ , $V_{\text{IN}}$ in Volts, $R_G$ in $\Omega$						A mA mA mA	
<b>ZERO OUTPUT</b> <sup>(1)</sup> Initial Error vs Temperature vs Supply Voltage, $V_+$ vs Common-Mode Voltage vs $V_{\text{REG}}$ Output Current Noise, 0.1Hz to 10Hz	$V_{\text{IN}} = 0\text{V}$ , $R_G = \infty$  $V_+ = 7.5\text{V}$ to $36\text{V}$ $V_{\text{CM}} = 1.25\text{V}$ to $3.5\text{V}$ <sup>(2)</sup>		4 ±5 ±0.07 0.04 0.02 0.3 0.03	±25 ±0.5 0.2		*	*	*	mA μA μA/°C μA/V μA/V μA/mA μA <sub>PP</sub>
<b>SPAN</b> Span Equation (transconductance) Initial Error <sup>(3)</sup> vs Temperature <sup>(3)</sup> Nonlinearity, Ideal Input <sup>(4)</sup>	Full-Scale ( $V_{\text{IN}}$ ) = 50mV  Full-Scale ( $V_{\text{IN}}$ ) = 50mV		$S = 40/R_G$ ±0.05 ±3 0.003	±0.2 ±25 0.01		*	*	*	A/V % ppm/°C %
<b>INPUT</b> <sup>(5)</sup> Offset Voltage vs Temperature vs Supply Voltage, $V_+$ vs Common-Mode Voltage, RTI (CMRR) Common-Mode Input Range <sup>(2)</sup> Input Bias Current vs Temperature Input Offset Current vs Temperature Impedance, Differential Common-Mode Noise, 0.1Hz to 10Hz	$V_{\text{CM}} = 2\text{V}$  $V_+ = 7.5\text{V}$ to $36\text{V}$ $V_{\text{CM}} = 1.25\text{V}$ to $3.5\text{V}$ <sup>(2)</sup>	1.25	±50 ±0.4 ±0.3 ±10	±100 ±1.5 ±3 ±50	*	*	*	*	μV μV/°C μV/V μV/V V nA pA/°C nA pA/°C GΩ    pF GΩ    pF μV <sub>PP</sub>
<b>CURRENT SOURCES</b> Current Accuracy vs Temperature vs Power Supply, $V_+$ Matching vs Temperature vs Power Supply, $V_+$ Compliance Voltage, Positive Negative <sup>(2)</sup> Output Impedance Noise, 0.1Hz to 10Hz	$V_O = 2\text{V}$ <sup>(6)</sup>  $V_+ = 7.5\text{V}$ to $36\text{V}$  $V_+ = 7.5\text{V}$ to $36\text{V}$	( $V_+$ ) - 3 0	800 ±0.05 ±15 ±10 ±0.02 ±3 1	±0.2 ±35 ±25 ±0.1 ±15 10	*	*	*	*	μA % ppm/°C ppm/V % ppm/°C ppm/V V V MΩ μA <sub>PP</sub>
<b><math>V_{\text{REG}}</math></b> <sup>(2)</sup> Accuracy vs Temperature vs Supply Voltage, $V_+$ Output Current Output Impedance			5.1 ±0.02 ±0.2 1 ±1 75	±0.1		*	*	*	V V mV/°C mV/V mA Ω
<b>LINEARIZATION</b> $R_{\text{LIN}}$ (internal) Accuracy vs Temperature			1 ±0.2 ±25	±0.5 ±100		*	*	*	kΩ % ppm/°C
<b>POWER SUPPLY</b> Specified Voltage Range		+7.5	+24	+36	*	*	*		V V
<b>TEMPERATURE RANGE</b> Specification, $T_{\text{MIN}}$ to $T_{\text{MAX}}$ Operating Storage Thermal Resistance, $\theta_{\text{JA}}$ DIP-14 SO-14 Surface-Mount		-40 -55 -55		+85 +125 +125	*	*	*		°C °C °C °C/W °C/W

\* Specification same as XTR105P and XTR105U.

NOTES: (1) Describes accuracy of the 4mA low-scale offset current. Does not include input amplifier effects. Can be trimmed to zero.

(2) Voltage measured with respect to  $I_{\text{RET}}$  pin.

(3) Does not include initial error or TCR of gain-setting resistor,  $R_G$ .

(4) Increasing the full-scale input range improves nonlinearity.

(5) Does not include Zero Output initial error.

(6) Current source output voltage with respect to  $I_{\text{RET}}$  pin.

# TYPICAL CHARACTERISTICS

At  $T_A = +25^\circ\text{C}$  and  $V_+ = 24\text{V}$ , unless otherwise noted.

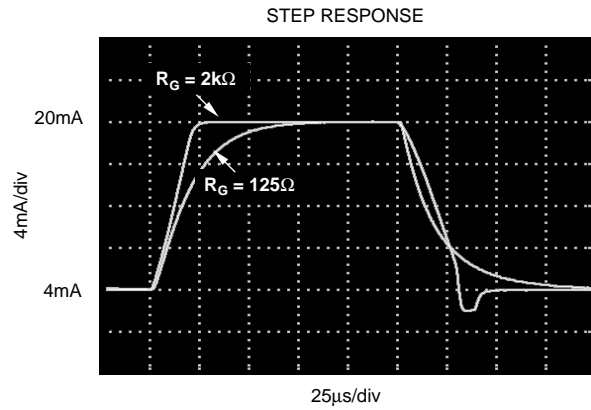

# TYPICAL CHARACTERISTICS (Cont.)

At  $T_A = +25^\circ\text{C}$  and  $V_+ = 24\text{V}$ , unless otherwise noted.

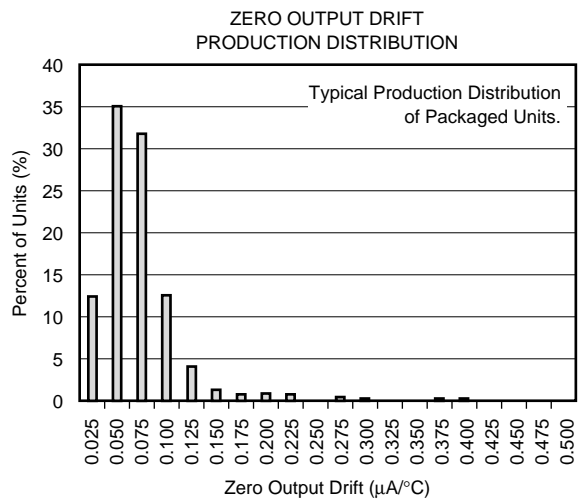

# TYPICAL CHARACTERISTICS (Cont.)

At  $T_A = +25^\circ\text{C}$  and  $V_+ = 24\text{V}$ , unless otherwise noted.



# APPLICATION INFORMATION

Figure 1 shows the basic connection diagram for the XTR105. The loop power supply,  $V_{PS}$ , provides power for all circuitry. Output loop current is measured as a voltage across the series load resistor,  $R_L$ .

Two matched 0.8mA current sources drive the RTD and zero-setting resistor,  $R_Z$ . The instrumentation amplifier input of the XTR105 measures the voltage difference between the RTD and  $R_Z$ . The value of  $R_Z$  is chosen to be equal to the resistance of the RTD at the low-scale (minimum) measurement temperature.  $R_Z$  can be adjusted to achieve 4mA output at the minimum measurement temperature to correct for input offset voltage and reference current mismatch of the XTR105.

$R_{CM}$  provides an additional voltage drop to bias the inputs of the XTR105 within their common-mode input range.  $R_{CM}$  should be bypassed with a 0.01 $\mu$ F capacitor to minimize common-mode noise. Resistor  $R_G$  sets the gain of the instrumentation amplifier according to the desired temperature range.  $R_{LIN1}$  provides 2nd-order linearization correction to the RTD, typically achieving a 40:1 improvement in linearity. An additional resistor is required for 3-wire RTD connections (see Figure 3).

The transfer function through the complete instrumentation amplifier and voltage-to-current converter is:

$$I_O = 4\text{mA} + V_{IN} \cdot (40/R_G)$$

$$(V_{IN} \text{ in volts, } R_G \text{ in ohms})$$

where  $V_{IN}$  is the differential input voltage.

As evident from the transfer function, if no  $R_G$  is used the gain is zero and the output is simply the XTR105's zero current. The value of  $R_G$  varies slightly for 2-wire RTD and 3-wire RTD connections with linearization.  $R_G$  can be calculated from the equations given in Figure 1 (2-wire RTD connection) and Table I (3-wire RTD connection).

The  $I_{RET}$  pin is the return path for all current from the current sources and  $V_{REG}$ . The  $I_{RET}$  pin allows any current used in external circuitry to be sensed by the XTR105 and to be included in the output current without causing an error.

The  $V_{REG}$  pin provides an on-chip voltage source of approximately 5.1V and is suitable for powering external input circuitry (refer to Figure 6). It is a moderately accurate voltage reference—it is not the same reference used to set the 800 $\mu$ A current references.  $V_{REG}$  is capable of sourcing approximately 1mA of current. Exceeding 1mA may affect the 4mA zero output.



FIGURE 1. Basic 2-Wire RTD Temperature Measurement Circuit with Linearization.

**MEASUREMENT TEMPERATURE SPAN  $\Delta T$  (°C)**

$T_{MIN}$	100°C	200°C	300°C	400°C	500°C	600°C	700°C	800°C	900°C	1000°C
-200°C	18.7/86.6 15000 16500	18.7/169 9760 11500	18.7/255 8060 10000	18.7/340 6650 8870	18.7/422 5620 7870	18.7/511 4750 7150	18.7/590 4020 6420	18.7/665 3480 5900	18.7/750 3090 5360	18.7/845 2740 4990
-100°C	60.4/80.6 27400 29400	60.4/162 15400 17800	60.4/243 10500 13000	60.4/324 7870 10200	60.4/402 6040 8660	60.4/487 4990 7500	60.4/562 4220 6490	60.4/649 3570 5900	60.4/732 3090 5360	
0°C	100/78.7 33200 35700	100/158 16200 18700	100/237 10500 13000	100/316 7680 10000	100/392 6040 8250	100/475 4870 7150	100/549 4020 6340	100/634 3480 5620		
100°C	137/75 31600 34000	137/150 15400 17800	137/226 10200 12400	137/301 7500 9760	137/383 5760 8060	137/453 4750 6810	137/536 3920 6040			
200°C	174/73.2 30900 33200	174/147 15000 17400	174/221 9760 12100	174/294 7150 9310	174/365 5620 7680	174/442 4530 6490				
300°C	210/71.5 30100 32400	210/143 14700 16500	210/215 9530 11500	210/287 6980 8870	210/357 5360 7320					
400°C	249/68.1 28700 30900	249/137 14000 16200	249/205 9090 11000	249/274 6650 8450						
500°C	280/66.5 28000 30100	280/133 13700 15400	280/200 8870 10500							
600°C	316/64.9 26700 28700	313/130 13000 14700								
700°C	348/61.9 26100 27400									
800°C	374/60.4 24900 26700									

$$\begin{bmatrix} R_Z/R_G \\ R_{LIN1} \\ R_{LIN2} \end{bmatrix}$$

NOTE: The values listed in this table are 1% resistors (in  $\Omega$ ). Exact values may be calculated from the following equations:

$R_Z$  = RTD resistance at minimum measured temperature.

$$R_G = \frac{2(R_2 - R_Z)(R_1 - R_Z)}{(R_2 - R_1)}$$

$$R_{LIN1} = \frac{R_{LIN}(R_2 - R_1)}{2(2R_1 - R_2 - R_Z)}$$

$$R_{LIN2} = \frac{(R_{LIN} + R_G)(R_2 - R_1)}{2(2R_1 - R_2 - R_Z)}$$

where:  $R_1$  = RTD resistance at  $(T_{MIN} + T_{MAX})/2$

$R_2$  = RTD resistance at  $T_{MAX}$

$R_{LIN}$  = 1k $\Omega$  (Internal)

**EXAMPLE:**

The measurement range is -100°C to +200°C for a 3-wire Pt100 RTD connection. Determine the values for  $R_Z$ ,  $R_G$ ,  $R_{LIN1}$ , and  $R_{LIN2}$ . Look up the values from the chart or calculate the values according to the equations provided.

**METHOD 1: TABLE LOOK UP**

For  $T_{MIN} = -100^\circ\text{C}$  and  $\Delta T = -300^\circ\text{C}$ , the 1% values are:

$$\begin{aligned} R_Z &= 60.4\Omega & R_{LIN1} &= 10.5\text{k}\Omega \\ R_G &= 243\Omega & R_{LIN2} &= 13\text{k}\Omega \end{aligned}$$

**METHOD 2: CALCULATION**

**Step 1:** Determine  $R_Z$ ,  $R_1$ , and  $R_2$ .

$R_Z$  is the RTD resistance at the minimum measured temperature,  $T_{MIN} = -100^\circ\text{C}$ . Using Equation 1 at right gives  $R_Z = 60.25\Omega$  (1% value is 60.4 $\Omega$ ).

$R_2$  is the RTD resistance at the maximum measured temperature,  $T_{MAX} = 200^\circ\text{C}$ . Using Equation 2 at right gives  $R_2 = 175.84\Omega$ .

$R_1$  is the RTD resistance at the midpoint measured temperature,  $T_{MID} = (T_{MIN} + T_{MAX})/2 = 50^\circ\text{C}$ .  $R_1$  is NOT the average of  $R_Z$  and  $R_2$ . Using Equation 2 at right gives  $R_1 = 119.40\Omega$ .

**Step 2:** Calculate  $R_G$ ,  $R_{LIN1}$ , and  $R_{LIN2}$  using equations above.

$$\begin{aligned} R_G &= 242.3\Omega \text{ (1% value is } 243\Omega) \\ R_{LIN1} &= 10.413\text{k}\Omega \text{ (1% value is } 10.5\text{k}\Omega) \\ R_{LIN2} &= 12.936\text{k}\Omega \text{ (1% value is } 13\text{k}\Omega) \end{aligned}$$

**Calculation of Pt100 Resistance Values**  
(according to DIN IEC 751)

(Equation 1) Temperature range from -200°C to 0°C:  

$$R_{(T)} = 100 [1 + 3.90802 \cdot 10^{-3} \cdot T - 0.5802 \cdot 10^{-6} \cdot T^2 - 4.27350 \cdot 10^{-12} (T - 100)^3]$$

(Equation 2) Temperature range from 0°C to +850°C:  

$$R_{(T)} = 100 (1 + 3.90802 \cdot 10^{-3} \cdot T - 0.5802 \cdot 10^{-6} \cdot T^2)$$

where:  $R_{(T)}$  is the resistance in  $\Omega$  at temperature T.  
 T is the temperature in  $^\circ\text{C}$ .

NOTE: Most RTD manufacturers provide reference tables for resistance values at various temperatures.

TABLE I.  $R_Z$ ,  $R_G$ ,  $R_{LIN1}$ , and  $R_{LIN2}$  Standard 1% Resistor Values for 3-Wire Pt100 RTD Connection with Linearization.

A negative input voltage,  $V_{IN}$ , will cause the output current to be less than 4mA. Increasingly negative  $V_{IN}$  will cause the output current to limit at approximately 2.2mA. Refer to the typical characteristic Under-Scale Current vs Temperature.

Increasingly positive input voltage (greater than the full-scale input) will produce increasing output current according to the transfer function, up to the output current limit of approximately 27mA. Refer to the typical characteristic Over-Scale Current vs Temperature.



## EXTERNAL TRANSISTOR

Transistor Q<sub>1</sub> conducts the majority of the signal-dependent 4-20mA loop current. Using an external transistor isolates the majority of the power dissipation from the precision input and reference circuitry of the XTR105, maintaining excellent accuracy.

Since the external transistor is inside a feedback loop, its characteristics are not critical. Requirements are: V<sub>CEO</sub> = 45V min, β = 40 min, and P<sub>D</sub> = 800mW. Power dissipation requirements may be lower if the loop power-supply voltage is less than 36V. Some possible choices for Q<sub>1</sub> are listed in Figure 1.

The XTR105 can be operated without this external transistor, however, accuracy will be somewhat degraded due to the internal power dissipation. Operation without Q<sub>1</sub> is not recommended for extended temperature ranges. A resistor (R = 3.3kΩ) connected between the I<sub>RET</sub> pin and the E (emitter) pin may be needed for operation below 0°C without Q<sub>1</sub> to ensure the full 20mA full-scale output, especially with V<sub>+</sub> near 7.5V.

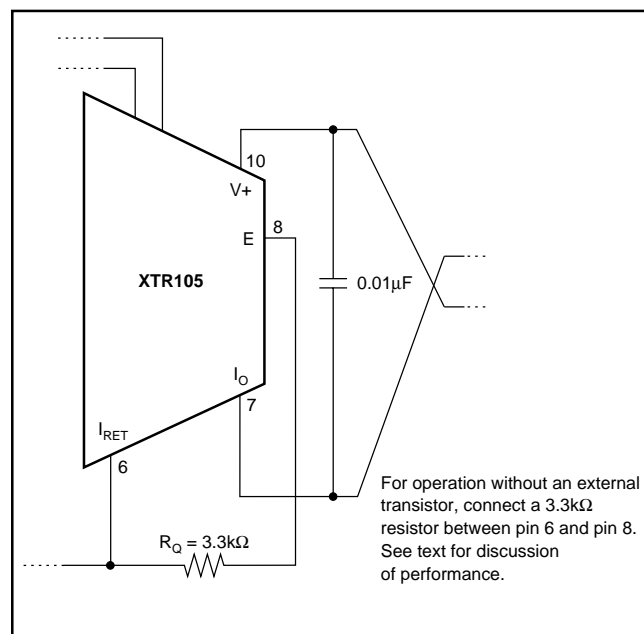

FIGURE 2. Operation Without an External Transistor.

## LOOP POWER SUPPLY

The voltage applied to the XTR105, V<sub>+</sub>, is measured with respect to the I<sub>O</sub> connection, pin 7. V<sub>+</sub> can range from 7.5V to 36V. The loop-supply voltage, V<sub>PS</sub>, will differ from the voltage applied to the XTR105 according to the voltage drop on the current sensing resistor, R<sub>L</sub> (plus any other voltage drop in the line).

If a low loop-supply voltage is used, R<sub>L</sub> (including the loop wiring resistance) must be made a relatively low value to assure that V<sub>+</sub> remains 7.5V or greater for the maximum loop current of 20mA:

$$R_L \max = \left( \frac{V_+ - 7.5V}{20mA} \right) - R_{WIRING}$$

It is recommended to design for V<sub>+</sub> equal or greater than 7.5V with loop currents up to 30mA to allow for out-of-range input conditions.

The low operating voltage (7.5V) of the XTR105 allows operation directly from personal computer power supplies (12V ±5%). When used with the RCV420 current loop receiver (see Figure 7), the load resistor voltage drop is limited to 3V.

## ADJUSTING INITIAL ERRORS

Many applications require adjustment of initial errors. Input offset and reference current mismatch errors can be corrected by adjustment of the zero resistor, R<sub>Z</sub>. Adjusting the gain-setting resistor, R<sub>G</sub>, corrects any errors associated with gain.

## 2- AND 3-WIRE RTD CONNECTIONS

In Figure 1, the RTD can be located remotely simply by extending the two connections to the RTD. With this remote 2-wire connection to the RTD, line resistance will introduce error. This error can be partially corrected by adjusting the values of R<sub>Z</sub>, R<sub>G</sub>, and R<sub>LIN1</sub>.

A better method for remotely located RTDs is the 3-wire RTD connection (see Figure 3). This circuit offers improved accuracy. R<sub>Z</sub>'s current is routed through a third wire to the RTD. Assuming line resistance is equal in RTD lines 1 and 2, this produces a small common-mode voltage that is rejected by the XTR105. A second resistor, R<sub>LIN2</sub>, is required for linearization.

Note that although the 2-wire and 3-wire RTD connection circuits are very similar, the gain-setting resistor, R<sub>G</sub>, has slightly different equations:

$$\text{2-wire: } R_G = \frac{2R_1(R_2 + R_Z) - 4(R_2R_Z)}{R_2 - R_1}$$

$$\text{3-wire: } R_G = \frac{2(R_2 - R_Z)(R_1 - R_Z)}{R_2 - R_1}$$

where: R<sub>Z</sub> = RTD resistance at T<sub>MIN</sub>

R<sub>1</sub> = RTD resistance at (T<sub>MIN</sub> + T<sub>MAX</sub>)/2

R<sub>2</sub> = RTD resistance at T<sub>MAX</sub>

To maintain good accuracy, at least 1% (or better) resistors should be used for R<sub>G</sub>. Table I provides standard 1% R<sub>G</sub> resistor values for a 3-wire Pt100 RTD connection with linearization.

## LINEARIZATION

RTD temperature sensors are inherently (but predictably) nonlinear. With the addition of one or two external resistors, R<sub>LIN1</sub> and R<sub>LIN2</sub>, it is possible to compensate for most of this nonlinearity resulting in 40:1 improvement in linearity over the uncompensated output.

See Figure 1 for a typical 2-wire RTD application with linearization. Resistor R<sub>LIN1</sub> provides positive feedback and controls linearity correction. R<sub>LIN1</sub> is chosen according to the desired temperature range. An equation is given in Figure 1.

In 3-wire RTD connections, an additional resistor,  $R_{LIN2}$ , is required. As with the 2-wire RTD application,  $R_{LIN1}$  provides positive feedback for linearization.  $R_{LIN2}$  provides an offset canceling current to compensate for wiring resistance encountered in remotely located RTDs.  $R_{LIN1}$  and  $R_{LIN2}$  are chosen such that their currents are equal. This makes the voltage drop in the wiring resistance to the RTD a common-mode signal that is rejected by the XTR105. The nearest standard 1% resistor values for  $R_{LIN1}$  and  $R_{LIN2}$  should be adequate for most applications. Table I provides the 1% resistor values for a 3-wire Pt100 RTD connection.

If no linearity correction is desired, the  $V_{LIN}$  pin should be left open. With no linearization,  $R_G = 2500 \cdot V_{FS}$ , where  $V_{FS}$  = full-scale input range.

### RTDs

The text and figures thus far have assumed a Pt100 RTD. With higher resistance RTDs, the temperature range and input voltage variation should be evaluated to ensure proper common-mode biasing of the inputs. As mentioned earlier,  $R_{CM}$  can be adjusted to provide an additional voltage drop to bias the inputs of the XTR105 within their common-mode input range.

### ERROR ANALYSIS

See Table II for how to calculate the effect various error sources have on circuit accuracy. A sample error calculation for a typical RTD measurement circuit (Pt100 RTD, 200°C measurement span) is provided. The results reveal the XTR105's excellent accuracy, in this case 1.1% unadjusted. Adjusting resistors  $R_G$  and  $R_Z$  for gain and offset errors improves circuit accuracy to 0.32%. Note that these are worst-case errors; ensured maximum values were used in the calculations and all errors were assumed to be positive (additive). The XTR105 achieves performance that is difficult to obtain with discrete circuitry and requires less space.

### OPEN-CIRCUIT PROTECTION

The optional transistor  $Q_2$  in Figure 3 provides predictable behavior with open-circuit RTD connections. It assures that if any one of the three RTD connections is broken, the XTR105's output current will go to either its high current limit ( $\approx 27\text{mA}$ ) or low current limit ( $\approx 2.2\text{mA}$ ). This is easily detected as an out-of-range condition.

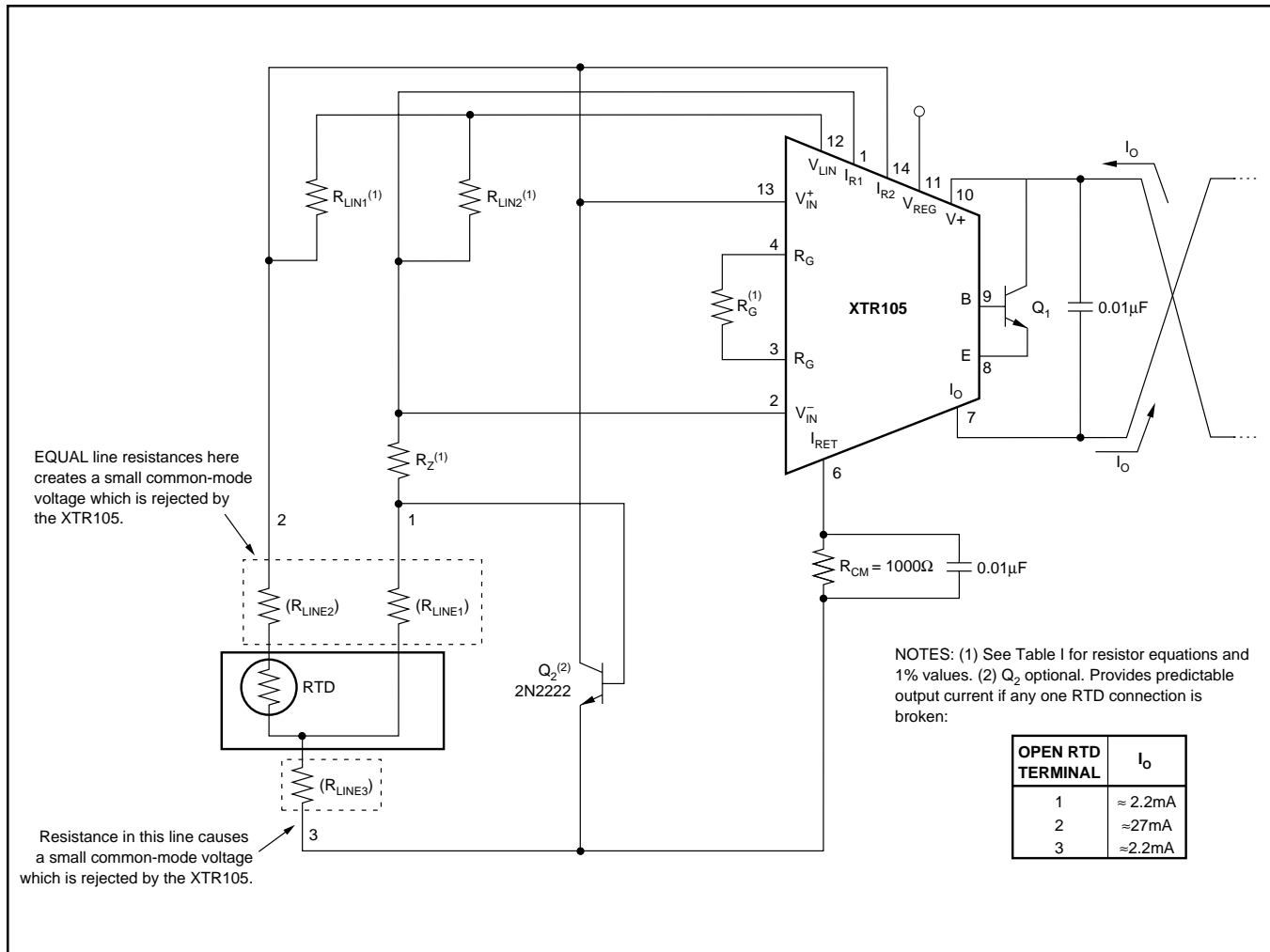

FIGURE 3. Remotely Located RTDs with 3-Wire Connection.

## SAMPLE ERROR CALCULATION

RTD value at 4mA Output ( $R_{RTD \text{ MIN}}$ ): 100Ω  
 RTD Measurement Range: 200°C  
 Ambient Temperature Range ( $\Delta T_A$ ): 20°C  
 Supply Voltage Change ( $\Delta V_+$ ): 5V  
 Common-Mode Voltage Change ( $\Delta CM$ ): 0.1V

ERROR SOURCE	ERROR EQUATION	SAMPLE ERROR CALCULATION <sup>(1)</sup>	ERROR (ppm of Full Scale)	
			UNADJ.	ADJUST.
<b>INPUT</b>				
Input Offset Voltage vs Common-Mode	$V_{OS}/(V_{IN \text{ MAX}}) \cdot 10^6$	$100\mu V/(800\mu A \cdot 0.38\Omega/^\circ C \cdot 200^\circ C) \cdot 10^6$	1645	0
Input Bias Current	$CMRR \cdot \Delta CM/(V_{IN \text{ MAX}}) \cdot 10^6$	$50\mu V/V \cdot 0.1V/(800\mu A \cdot 0.38\Omega/^\circ C \cdot 200^\circ C) \cdot 10^6$	82	82
Input Offset Current	$I_B/I_{REF} \cdot 10^6$	$0.025\mu A/800\mu A \cdot 10^6$	31	0
	$I_{OS} \cdot R_{RTD \text{ MIN}}/(V_{IN \text{ MAX}}) \cdot 10^6$	$3nA \cdot 100\Omega/(800\mu A \cdot 0.38\Omega/^\circ C \cdot 200^\circ C) \cdot 10^6$	5	0
		<b>Total Input Error:</b>	<b>1763</b>	<b>82</b>
<b>EXCITATION</b>				
Current Reference Accuracy vs Supply	$I_{REF} \text{ Accuracy } (\%)/100\% \cdot 10^6$	$0.2\%/100\% \cdot 10^6$	2000	0
Current Reference Matching vs Supply	$(I_{REF} \text{ vs } V_+) \cdot \Delta V_+$ $I_{REF} \text{ Matching } (\%)/100\% \cdot 800\mu A \cdot R_{RTD \text{ MIN}}/(V_{IN \text{ MAX}}) \cdot 10^6$	$25\text{ppm}/V \cdot 5V$ $0.1\%/100\% \cdot 800\mu A \cdot 100\Omega/(800\mu A \cdot 0.38\Omega/^\circ C \cdot 200^\circ C) \cdot 10^6$	125	125
	$(I_{REF} \text{ Matching vs } V_+) \cdot \Delta V_+ \cdot R_{RTD \text{ MIN}}/(V_{IN \text{ MAX}})$	$10\text{ppm}/V \cdot 5V \cdot 800\mu A \cdot 100\Omega/(800\mu A \cdot 0.38\Omega/^\circ C \cdot 200^\circ C)$	66	66
		<b>Total Excitation Error:</b>	<b>3507</b>	<b>191</b>
<b>GAIN</b>				
Span	Span Error (%) / 100% • 10 <sup>6</sup>	$0.2\%/100\% \cdot 10^6$	2000	0
Nonlinearity	Nonlinearity (%) / 100% • 10 <sup>6</sup>	$0.01\%/100\% \cdot 10^6$	100	100
		<b>Total Gain Error:</b>	<b>2100</b>	<b>100</b>
<b>OUTPUT</b>				
Zero Output vs Supply	$(I_{ZERO} - 4mA) / 16000\mu A \cdot 10^6$ $(I_{ZERO} \text{ vs } V_+) \cdot \Delta V_+ / 16000\mu A \cdot 10^6$	$25\mu A/16000\mu A \cdot 10^6$ $0.2\mu A/V \cdot 5V/16000\mu A \cdot 10^6$	1563	0
		<b>Total Output Error:</b>	<b>63</b>	<b>63</b>
<b>DRIFT (<math>\Delta T_A = 20^\circ C</math>)</b>				
Input Offset Voltage	Drift • $\Delta T_A/(V_{IN \text{ MAX}}) \cdot 10^6$	$1.5\mu V/^\circ C \cdot 20^\circ C/(800\mu A \cdot 0.38\Omega/^\circ C \cdot 200^\circ C) \cdot 10^6$	493	493
Input Bias Current (typical)	Drift • $\Delta T_A/800\mu A \cdot 10^6$	$20\text{pA}/^\circ C \cdot 20^\circ C/800\mu A \cdot 10^6$	0.5	0.5
Input Offset Current (typical)	Drift • $\Delta T_A \cdot R_{RTD \text{ MIN}}/(V_{IN \text{ MAX}}) \cdot 10^6$	$5\text{pA}/^\circ C \cdot 20^\circ C \cdot 100\Omega/(800\mu A \cdot 0.38\Omega/^\circ C \cdot 200^\circ C) \cdot 10^6$	0.2	0.2
Current Reference Accuracy	Drift • $\Delta T_A$	$35\text{ppm}/^\circ C \cdot 20^\circ C$	700	700
Current Reference Matching	Drift • $\Delta T_A \cdot 800\mu A \cdot R_{RTD \text{ MIN}}/(V_{IN \text{ MAX}})$	$15\text{ppm}/^\circ C \cdot 20^\circ C \cdot 800\mu A \cdot 100\Omega/(800\mu A \cdot 0.38\Omega/^\circ C \cdot 200^\circ C)$	395	395
Span	Drift • $\Delta T_A$	$25\text{ppm}/^\circ C \cdot 20^\circ C$	500	500
Zero Output	Drift • $\Delta T_A/16000\mu A \cdot 10^6$	$0.5\mu A/^\circ C \cdot 20^\circ C/16000\mu A \cdot 10^6$	626	626
		<b>Total Drift Error:</b>	<b>2715</b>	<b>2715</b>
<b>NOISE (0.1Hz to 10Hz, typ)</b>				
Input Offset Voltage	$v_n/(V_{IN \text{ MAX}}) \cdot 10^6$	$0.6\mu V/(800\mu A \cdot 0.38\Omega/^\circ C \cdot 200^\circ C) \cdot 10^6$	10	10
Current Reference	$I_{REF} \text{ Noise} \cdot R_{RTD \text{ MIN}}/(V_{IN \text{ MAX}}) \cdot 10^6$	$3nA \cdot 100\Omega/(800\mu A \cdot 0.38\Omega/^\circ C \cdot 200^\circ C) \cdot 10^6$	5	5
Zero Output	$I_{ZERO} \text{ Noise}/16000\mu A \cdot 10^6$	$0.03\mu A/16000\mu A \cdot 10^6$	2	2
		<b>Total Noise Error:</b>	<b>17</b>	<b>17</b>

NOTE (1): All errors are min/max and referred to input unless otherwise stated.

**TOTAL ERROR: 11728 3168**  
**(1.17%) (0.32%)**

TABLE II. Error Calculation.

## REVERSE-VOLTAGE PROTECTION

The XTR105's low compliance rating (7.5V) permits the use of various voltage protection methods without compromising operating range. Figure 4 shows a diode bridge circuit that allows normal operation even when the voltage connection lines are reversed. The bridge causes a two diode drop (approximately 1.4V) loss in loop-supply voltage. This results in a compliance voltage of approximately 9V—satisfactory for most applications. If a 1.4V drop in loop supply is too much, a diode can be inserted in series with the loop-supply voltage and the V+ pin. This protects against reverse output connection lines with only a 0.7V loss in loop-supply voltage.

## SURGE PROTECTION

Remote connections to current transmitters can sometimes be subjected to voltage surges. It is prudent to limit the maximum surge voltage applied to the XTR105 to as low as practical. Various zener diodes and surge clamping diodes are specially designed for this purpose. Select a clamp diode with as low a voltage rating as possible for best protection. For example, a 36V protection diode will assure proper transmitter operation at normal loop voltages, yet will provide an appropriate level of protection against voltage surges. Characterization tests on three production lots showed no damage to the XTR105 within loop-supply voltages up to 65V.

Most surge protection zener diodes have a diode characteristic in the forward direction that will conduct excessive current, possibly damaging receiving-side circuitry if the loop connections are reversed. If a surge protection diode is used, a series diode or diode bridge should be used for protection against reversed connections.

## RADIO FREQUENCY INTERFERENCE

The long wire lengths of current loops invite radio frequency (RF) interference. RF can be rectified by the sensitive input circuitry of the XTR105 causing errors. This generally appears as an unstable output current that varies with the position of loop supply or input wiring.

If the RTD sensor is remotely located, the interference may enter at the input terminals. For integrated transmitter assemblies with short connections to the sensor, the interference more likely comes from the current loop connections.

Bypass capacitors on the input reduce or eliminate this input interference. Connect these bypass capacitors to the I<sub>RET</sub> terminal (see Figure 5). Although the dc voltage at the I<sub>RET</sub> terminal is not equal to 0V (at the loop supply, V<sub>PS</sub>), this circuit point can be considered the transmitter's "ground." The 0.01μF capacitor connected between V+ and I<sub>O</sub> may help minimize output interference.



FIGURE 4. Reverse Voltage Operation and Over-Voltage Surge Protection.



FIGURE 5. Input Bypassing Technique with Linearization.



FIGURE 6. Thermocouple Low Offset, Low Drift Loop Measurement with Diode Cold Junction Compensation.



FIGURE 7.  $\pm 12V$  Powered Transmitter/Receiver Loop.



FIGURE 8. Isolated Transmitter/Receiver Loop.



FIGURE 9. Bridge Input, Current Excitation.

**PACKAGING INFORMATION**

Orderable Device	Status <sup>(1)</sup>	Package Type	Package Drawing	Pins	Package Qty	Eco Plan <sup>(2)</sup>	Lead/Ball Finish	MSL Peak Temp <sup>(3)</sup>
XTR105P	ACTIVE	PDIP	N	14	25	Green (RoHS & no Sb/Br)	CU NIPDAU	N / A for Pkg Type
XTR105PA	ACTIVE	PDIP	N	14	25	Green (RoHS & no Sb/Br)	CU NIPDAU	N / A for Pkg Type
XTR105PAG4	ACTIVE	PDIP	N	14	25	Green (RoHS & no Sb/Br)	CU NIPDAU	N / A for Pkg Type
XTR105PG4	ACTIVE	PDIP	N	14	25	Green (RoHS & no Sb/Br)	CU NIPDAU	N / A for Pkg Type
XTR105U	ACTIVE	SOIC	D	14	58	Green (RoHS & no Sb/Br)	CU NIPDAU	Level-3-260C-168 HR
XTR105UA	ACTIVE	SOIC	D	14	58	Green (RoHS & no Sb/Br)	CU NIPDAU	Level-3-260C-168 HR
XTR105UA/2K5	ACTIVE	SOIC	D	14	2500	Green (RoHS & no Sb/Br)	Call TI	Level-3-260C-168 HR
XTR105UA/2K5E4	ACTIVE	SOIC	D	14	2500	Green (RoHS & no Sb/Br)	Call TI	Level-3-260C-168 HR
XTR105UAG4	ACTIVE	SOIC	D	14	58	Green (RoHS & no Sb/Br)	CU NIPDAU	Level-3-260C-168 HR
XTR105UG4	ACTIVE	SOIC	D	14	58	Green (RoHS & no Sb/Br)	CU NIPDAU	Level-3-260C-168 HR

<sup>(1)</sup> The marketing status values are defined as follows:

**ACTIVE:** Product device recommended for new designs.

**LIFEBUY:** TI has announced that the device will be discontinued, and a lifetime-buy period is in effect.

**NRND:** Not recommended for new designs. Device is in production to support existing customers, but TI does not recommend using this part in a new design.

**PREVIEW:** Device has been announced but is not in production. Samples may or may not be available.

**OBsolete:** TI has discontinued the production of the device.

<sup>(2)</sup> Eco Plan - The planned eco-friendly classification: Pb-Free (RoHS), Pb-Free (RoHS Exempt), or Green (RoHS & no Sb/Br) - please check <http://www.ti.com/productcontent> for the latest availability information and additional product content details.

**TBD:** The Pb-Free/Green conversion plan has not been defined.

**Pb-Free (RoHS):** TI's terms "Lead-Free" or "Pb-Free" mean semiconductor products that are compatible with the current RoHS requirements for all 6 substances, including the requirement that lead not exceed 0.1% by weight in homogeneous materials. Where designed to be soldered at high temperatures, TI Pb-Free products are suitable for use in specified lead-free processes.

**Pb-Free (RoHS Exempt):** This component has a RoHS exemption for either 1) lead-based flip-chip solder bumps used between the die and package, or 2) lead-based die adhesive used between the die and leadframe. The component is otherwise considered Pb-Free (RoHS compatible) as defined above.

**Green (RoHS & no Sb/Br):** TI defines "Green" to mean Pb-Free (RoHS compatible), and free of Bromine (Br) and Antimony (Sb) based flame retardants (Br or Sb do not exceed 0.1% by weight in homogeneous material)

<sup>(3)</sup> MSL, Peak Temp. -- The Moisture Sensitivity Level rating according to the JEDEC industry standard classifications, and peak solder temperature.

**Important Information and Disclaimer:** The information provided on this page represents TI's knowledge and belief as of the date that it is provided. TI bases its knowledge and belief on information provided by third parties, and makes no representation or warranty as to the accuracy of such information. Efforts are underway to better integrate information from third parties. TI has taken and continues to take reasonable steps to provide representative and accurate information but may not have conducted destructive testing or chemical analysis on incoming materials and chemicals. TI and TI suppliers consider certain information to be proprietary, and thus CAS numbers and other limited information may not be available for release.

In no event shall TI's liability arising out of such information exceed the total purchase price of the TI part(s) at issue in this document sold by TI to Customer on an annual basis.



D (R-PDSO-G14)

PLASTIC SMALL-OUTLINE PACKAGE

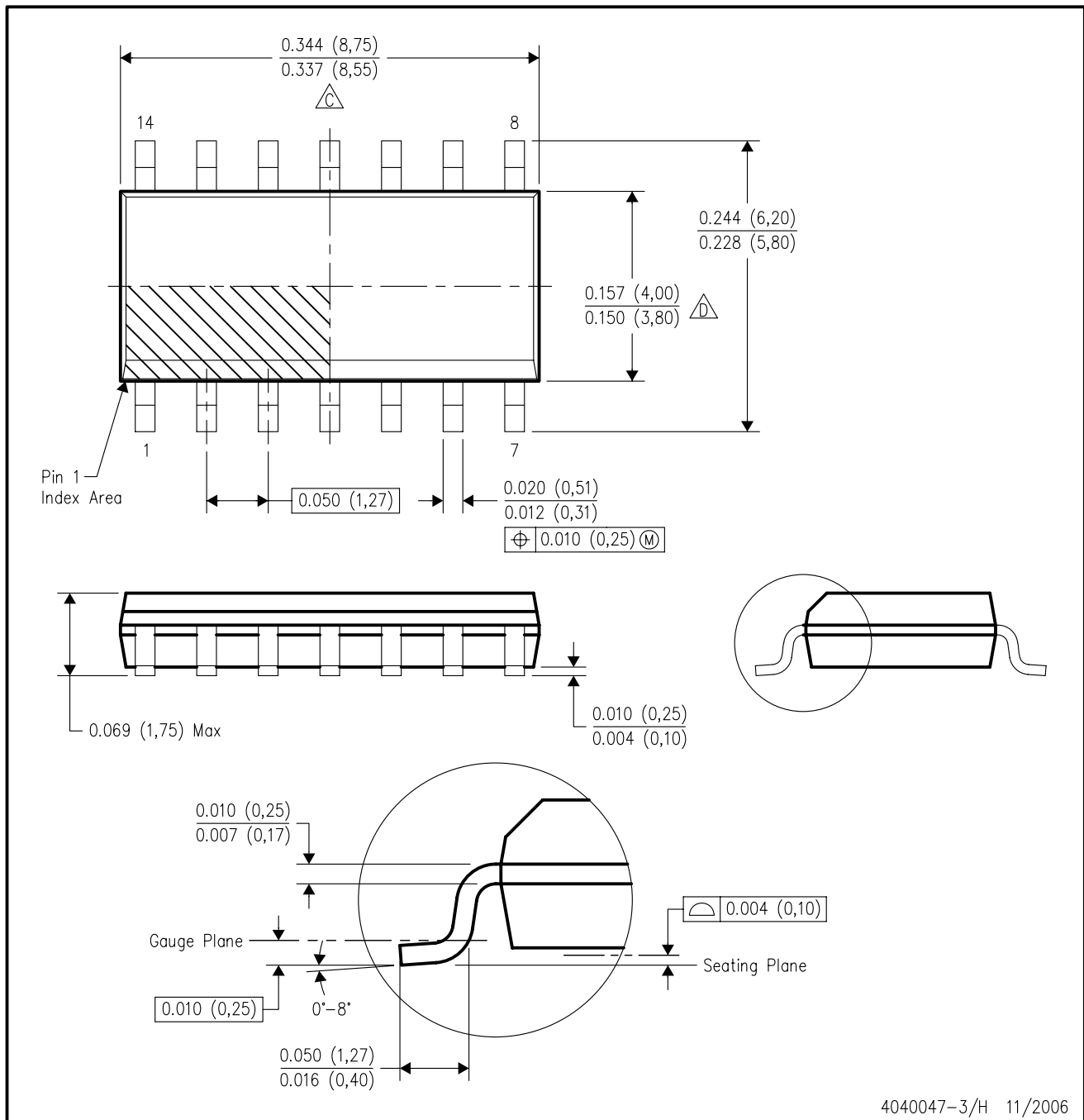

- NOTES:
- A. All linear dimensions are in inches (millimeters).
  - B. This drawing is subject to change without notice.
  - C. Body length does not include mold flash, protrusions, or gate burrs. Mold flash, protrusions, or gate burrs shall not exceed .006 (0,15) per end.
  - D. Body width does not include interlead flash. Interlead flash shall not exceed .017 (0,43) per side.
  - E. Reference JEDEC MS-012 variation AB.

## IMPORTANT NOTICE

Texas Instruments Incorporated and its subsidiaries (TI) reserve the right to make corrections, modifications, enhancements, improvements, and other changes to its products and services at any time and to discontinue any product or service without notice. Customers should obtain the latest relevant information before placing orders and should verify that such information is current and complete. All products are sold subject to TI's terms and conditions of sale supplied at the time of order acknowledgment.

TI warrants performance of its hardware products to the specifications applicable at the time of sale in accordance with TI's standard warranty. Testing and other quality control techniques are used to the extent TI deems necessary to support this warranty. Except where mandated by government requirements, testing of all parameters of each product is not necessarily performed.

TI assumes no liability for applications assistance or customer product design. Customers are responsible for their products and applications using TI components. To minimize the risks associated with customer products and applications, customers should provide adequate design and operating safeguards.

TI does not warrant or represent that any license, either express or implied, is granted under any TI patent right, copyright, mask work right, or other TI intellectual property right relating to any combination, machine, or process in which TI products or services are used. Information published by TI regarding third-party products or services does not constitute a license from TI to use such products or services or a warranty or endorsement thereof. Use of such information may require a license from a third party under the patents or other intellectual property of the third party, or a license from TI under the patents or other intellectual property of TI.

Reproduction of TI information in TI data books or data sheets is permissible only if reproduction is without alteration and is accompanied by all associated warranties, conditions, limitations, and notices. Reproduction of this information with alteration is an unfair and deceptive business practice. TI is not responsible or liable for such altered documentation. Information of third parties may be subject to additional restrictions.

Resale of TI products or services with statements different from or beyond the parameters stated by TI for that product or service voids all express and any implied warranties for the associated TI product or service and is an unfair and deceptive business practice. TI is not responsible or liable for any such statements.

TI products are not authorized for use in safety-critical applications (such as life support) where a failure of the TI product would reasonably be expected to cause severe personal injury or death, unless officers of the parties have executed an agreement specifically governing such use. Buyers represent that they have all necessary expertise in the safety and regulatory ramifications of their applications, and acknowledge and agree that they are solely responsible for all legal, regulatory and safety-related requirements concerning their products and any use of TI products in such safety-critical applications, notwithstanding any applications-related information or support that may be provided by TI. Further, Buyers must fully indemnify TI and its representatives against any damages arising out of the use of TI products in such safety-critical applications.

TI products are neither designed nor intended for use in military/aerospace applications or environments unless the TI products are specifically designated by TI as military-grade or "enhanced plastic." Only products designated by TI as military-grade meet military specifications. Buyers acknowledge and agree that any such use of TI products which TI has not designated as military-grade is solely at the Buyer's risk, and that they are solely responsible for compliance with all legal and regulatory requirements in connection with such use.

TI products are neither designed nor intended for use in automotive applications or environments unless the specific TI products are designated by TI as compliant with ISO/TS 16949 requirements. Buyers acknowledge and agree that, if they use any non-designated products in automotive applications, TI will not be responsible for any failure to meet such requirements.

Following are URLs where you can obtain information on other Texas Instruments products and application solutions:

### Products

Amplifiers	<a href="http://amplifier.ti.com">amplifier.ti.com</a>
Data Converters	<a href="http://dataconverter.ti.com">dataconverter.ti.com</a>
DSP	<a href="http://dsp.ti.com">dsp.ti.com</a>
Clocks and Timers	<a href="http://www.ti.com/clocks">www.ti.com/clocks</a>
Interface	<a href="http://interface.ti.com">interface.ti.com</a>
Logic	<a href="http://logic.ti.com">logic.ti.com</a>
Power Mgmt	<a href="http://power.ti.com">power.ti.com</a>
Microcontrollers	<a href="http://microcontroller.ti.com">microcontroller.ti.com</a>
RFID	<a href="http://www.ti-rfid.com">www.ti-rfid.com</a>
RF/IF and ZigBee® Solutions	<a href="http://www.ti.com/lprf">www.ti.com/lprf</a>

### Applications

Audio	<a href="http://www.ti.com/audio">www.ti.com/audio</a>
Automotive	<a href="http://www.ti.com/automotive">www.ti.com/automotive</a>
Broadband	<a href="http://www.ti.com/broadband">www.ti.com/broadband</a>
Digital Control	<a href="http://www.ti.com/digitalcontrol">www.ti.com/digitalcontrol</a>
Medical	<a href="http://www.ti.com/medical">www.ti.com/medical</a>
Military	<a href="http://www.ti.com/military">www.ti.com/military</a>
Optical Networking	<a href="http://www.ti.com/opticalnetwork">www.ti.com/opticalnetwork</a>
Security	<a href="http://www.ti.com/security">www.ti.com/security</a>
Telephony	<a href="http://www.ti.com/telephony">www.ti.com/telephony</a>
Video & Imaging	<a href="http://www.ti.com/video">www.ti.com/video</a>
Wireless	<a href="http://www.ti.com/wireless">www.ti.com/wireless</a>

Mailing Address: Texas Instruments, Post Office Box 655303, Dallas, Texas 75265  
Copyright © 2008, Texas Instruments Incorporated