

Small-Signal Diode

Features

- These diodes are also available in other case styles including the DO-35 case with the type designation 1N4148, the MiniMELF case with the type designation LL4148, and the SOT-23 case with the type designation IMBD4148.
- Silicon Epitaxial Planar Diode
- Fast switching diodes

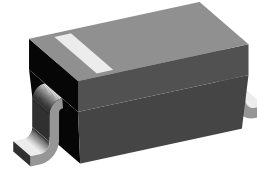

17431

Mechanical Data

Case: SOD-323 Plastic Case

Weight: approx. 5.0 mg

Packaging Codes/Options:

GS18 / 10 k per 13" reel (8 mm tape), 10 k/box

GS08 / 3 k per 7" reel (8 mm tape), 15 k/box

Parts Table

Part	Ordering code	Marking	Remarks
1N4148WS	1N4148WS-GS18 or 1N4148WS-GS08	A2	Tape and Reel

Absolute Maximum Ratings

T_{amb} = 25 °C, unless otherwise specified

Parameter	Test condition	Symbol	Value	Unit
Reverse voltage		V _R	75	V
Peak reverse voltage		V _{RM}	100	V
Average rectified current half wave rectification with resistive load	f ≥ 50 Hz	I _{F(AV)}	150 ¹⁾	mA
Surge forward current	t < 1 s and T _j = 25 °C	I _{FSM}	350	mA
Power dissipation		P _{tot}	200 ¹⁾	mW

¹⁾ Valid provided that electrodes are kept at ambient temperature.

Thermal Characteristics

T_{amb} = 25 °C, unless otherwise specified

Parameter	Test condition	Symbol	Value	Unit
Thermal resistance junction to ambient air		R _{thJA}	650 ¹⁾	°C/W
Junction temperature		T _j	150	°C
Storage temperature		T _S	- 65 to + 150	°C

¹⁾ Valid provided that electrodes are kept at ambient temperature.

Electrical Characteristics

$T_{amb} = 25\text{ }^{\circ}\text{C}$, unless otherwise specified

Parameter	Test condition	Symbol	Min	Typ.	Max	Unit
Forward voltage	$I_F = 10\text{ mA}$	V_F			1.0	V
Leakage current	$V_R = 20\text{ V}$				25	nA
	$V_R = 75\text{ V}$				5.0	μA
	$V_R = 20\text{ V}, T_J = 150\text{ }^{\circ}\text{C}$				50	μA
Diode capacitance	$V_F = V_R = 0\text{ V}$	C_{tot}			4	pF
Voltage rise when switching ON (tested with 50 mA pulses)	tested with 50 mA pulses, $t_p = 0.1\text{ }\mu\text{s}$, rise time < 30 ns, $f_p = (5\text{ to }100)\text{ kHz}$	V_{fr}			2.5	ns
Reverse recovery time	$I_F = 10\text{ mA}, I_R = 1\text{ mA}, V_R = 6\text{ V}, R_L = 100\text{ }\Omega$	t_{rr}			4	ns
Rectification efficiency	$f = 100\text{ MHz}, V_{RF} = 2\text{ V}$	η_v	0.45			

Rectification Efficiency Measurement Circuit

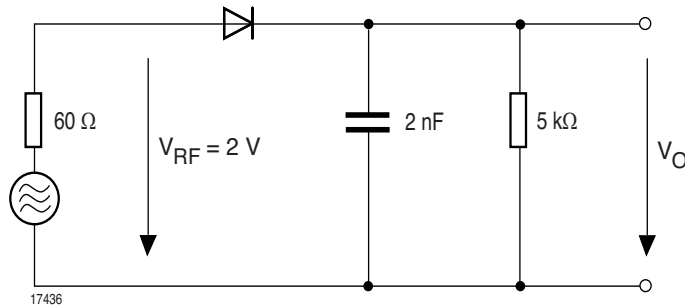

Typical Characteristics ($T_{amb} = 25\text{ }^{\circ}\text{C}$ unless otherwise specified)

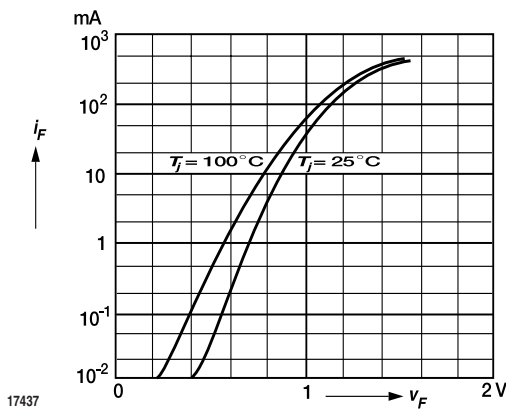

Fig. 1 Forward characteristics

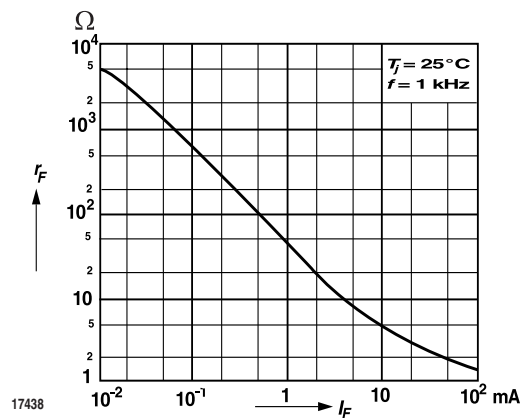

Fig. 2 Dynamic Forward Resistance vs. Forward Current

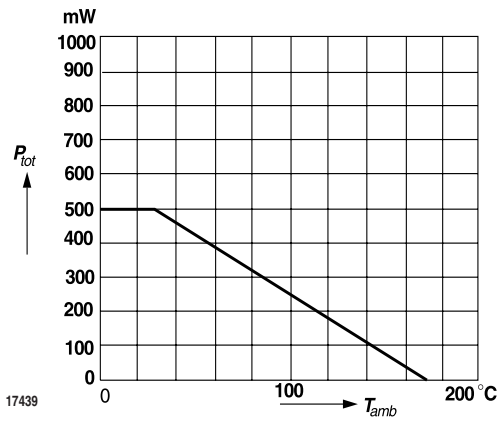

Fig. 3 Admissible Power Dissipation vs. Ambient Temperature

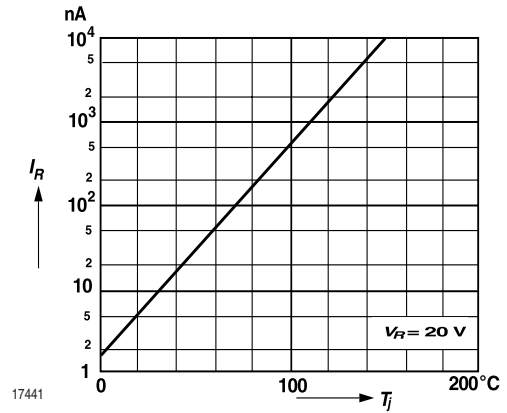

Fig. 5 Leakage Current vs. Junction Temperature

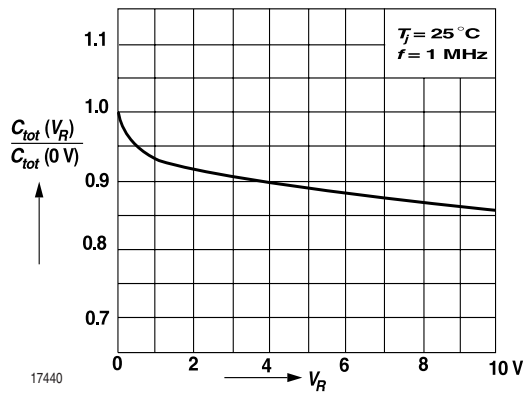

Fig. 4 Relative Capacitance vs. Reverse Voltage

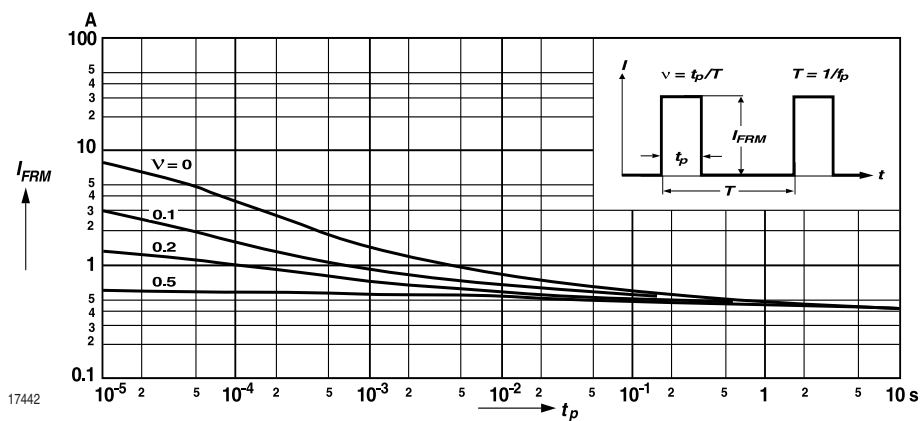

Fig. 6 Admissible Repetitive Peak Forward Current vs. Pulse Duration

1N4148WS

Vishay Semiconductors



Package Dimensions in mm (Inches)

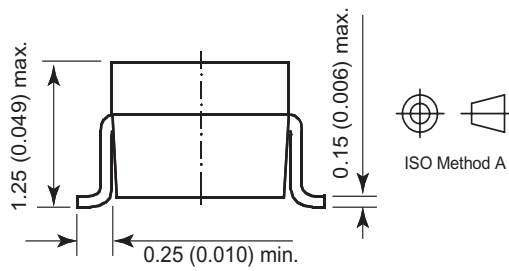
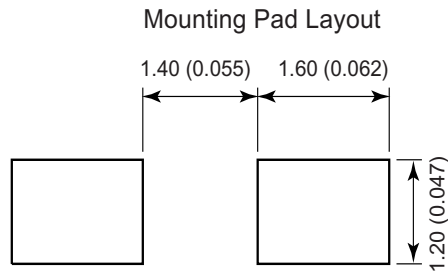
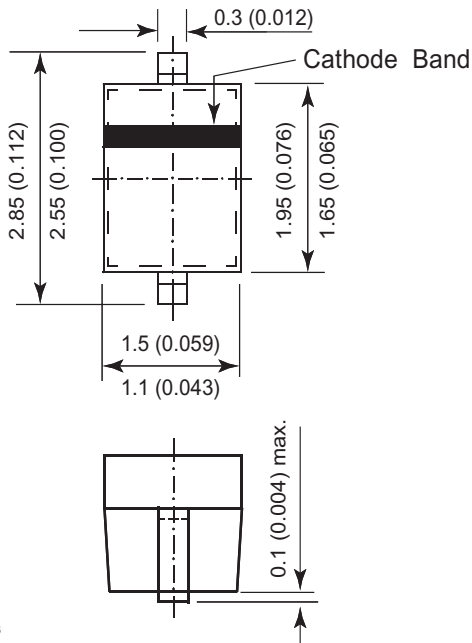

17443



Ozone Depleting Substances Policy Statement

It is the policy of **Vishay Semiconductor GmbH** to

1. Meet all present and future national and international statutory requirements.
2. Regularly and continuously improve the performance of our products, processes, distribution and operating systems with respect to their impact on the health and safety of our employees and the public, as well as their impact on the environment.

It is particular concern to control or eliminate releases of those substances into the atmosphere which are known as ozone depleting substances (ODSs).

The Montreal Protocol (1987) and its London Amendments (1990) intend to severely restrict the use of ODSs and forbid their use within the next ten years. Various national and international initiatives are pressing for an earlier ban on these substances.

Vishay Semiconductor GmbH has been able to use its policy of continuous improvements to eliminate the use of ODSs listed in the following documents.

1. Annex A, B and list of transitional substances of the Montreal Protocol and the London Amendments respectively
2. Class I and II ozone depleting substances in the Clean Air Act Amendments of 1990 by the Environmental Protection Agency (EPA) in the USA
3. Council Decision 88/540/EEC and 91/690/EEC Annex A, B and C (transitional substances) respectively.

Vishay Semiconductor GmbH can certify that our semiconductors are not manufactured with ozone depleting substances and do not contain such substances.

**We reserve the right to make changes to improve technical design
and may do so without further notice.**

Parameters can vary in different applications. All operating parameters must be validated for each customer application by the customer. Should the buyer use Vishay Semiconductors products for any unintended or unauthorized application, the buyer shall indemnify Vishay Semiconductors against all claims, costs, damages, and expenses, arising out of, directly or indirectly, any claim of personal damage, injury or death associated with such unintended or unauthorized use.

Vishay Semiconductor GmbH, P.O.B. 3535, D-74025 Heilbronn, Germany
Telephone: 49 (0)7131 67 2831, Fax number: 49 (0)7131 67 2423