



Positronic Industries
connect@positronic.com

MILITARY QUALITY, REMOVABLE CONTACT, HIGH DENSITY SUBMINIATURE-D CONNECTORS

D-Sub

FOR MILITARY AND SEVERE INDUSTRIAL ENVIRONMENTAL APPLICATIONS

Size 22 Signal and
Thermocouple Contacts,
Removable Crimp and
Printed Board Mount

Military/Industrial
Quality Connectors

MIL-DTL-24308 and MIL-C-39029

U.L. Recognized

File #E49351

CSA Recognized

File #LR54219

Telecommunication

U.L. File #14098

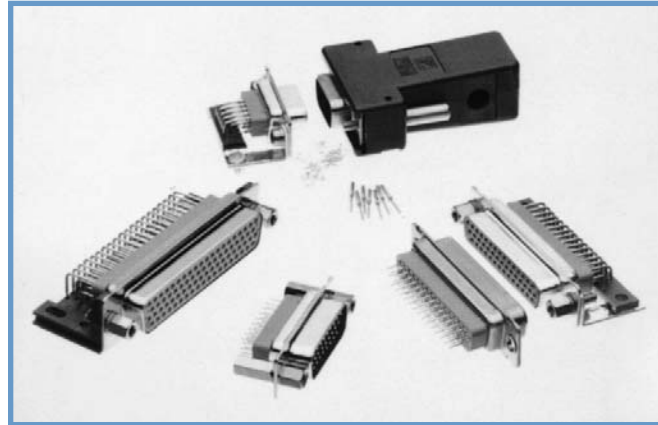

DD SERIES

Densi-D Series connectors are Military/Industrial quality, high density rectangular connectors designed for use in sheltered, mildly corrosive environments having a wide range of temperature, pressure and humidity changes. These crimp removable contact connectors are qualified to MIL-DTL-24308 and MIL-C-39029.

Densi-D Series connectors utilize precision machined contacts with closed barrel crimp terminations, solder cup terminations, straight and 90° printed board mount. All female contacts are of closed entry design, featuring a fluted stainless steel shroud.

Six standard contact variants are offered in arrangements of 15, 26, 44, 62, 78 and 104 contacts. Densi-D Series connectors are mateable

and compatible with other high density D-Subminiature connectors conforming to MIL-DTL-24308.

A wide assortment of mounting spacers, cable support hoods and locking systems is available from stock.



Contact Technical
Sales for details.

DENSI-D SERIES TECHNICAL CHARACTERISTICS

MATERIALS AND FINISHES:

Insulators:	Glass filled polyester per MIL-M-24519, UL 94V-0, blue color.
Contacts:	Male contacts – precision machined high tensile copper alloy. Female contacts – precision machined high tensile copper alloy with stainless steel shroud.
Contact Plating:	Military performance – 0.000050 inch [1.27 microns] gold over copper plate. Industrial performance – gold flash over nickel plate. Other finishes available upon request.
Shells:	Steel with tin plate; zinc and cadmium plate with dichromate seal, stainless steel, passivated. Other materials and finishes available upon request.
Mounting Spacers:	Nylon plastic and brass; zinc plate with dichromate seal.
Push-On Fastener:	Phosphor bronze or beryllium copper with tin plate.
Vibration Lock Systems:	Slide lock and lock tabs, steel with nickel plate.
Jackscrew Systems:	Steel with zinc plate and dichromate seal, or clear zinc plate.
Hoods:	Thermoplastic UL 94V-0. Composite, brass or steel with zinc plate and dichromate seal.

ELECTRICAL CHARACTERISTICS:

Contact Current Rating:	5 amperes nominal.
Initial Contact Resistance:	0.005 ohms maximum.
Proof Voltage:	1000 V r.m.s.
Insulator Resistance:	5 G ohms.
Clearance and Creepage Distance [minimum]:	0.042 inch [1.06mm].
Working Voltage:	300 V r.m.s.

CLIMATIC CHARACTERISTICS:

Temperature Range:	-55°C to +125°C.
Damp Heat, Steady State:	21 days.

MECHANICAL CHARACTERISTICS:

Removable Contacts:	Insert contact to rear face of insulator and release from rear face of insulator. Size 22 contacts, male – 0.030 inch [0.76mm] diameter; female – closed entry design with stainless steel shroud.
Contact Retention In Insulator:	9 lbs. [40 N].
Contact Terminations:	Closed barrel crimp, wire sizes 22 AWG [0.3mm ²] through 30 AWG [0.05mm ²] per IEC 352-2.
Shells:	90° Printed Board Mount contact terminations. Male shells may be dimpled for EMI/ESD ground paths.
Polarization:	Trapezoidally shaped shells and polarized jackscrews.
Mounting To Angle Brackets:	Jackscrews and riveted fasteners with 0.120 inch [3.05mm] clearance hole, and threaded riveted fasteners with 4-40 threads and nylon lock inserts.
Mounting To Printed Board:	Rapid installation push-on fasteners and mounting posts.
Locking Systems:	Jackscrews and vibration locking systems.
Mechanical Operations:	1000 operations minimum per IEC 512-5.

THERMOCOUPLE CONTACTS:

Size 22 crimp contacts are available, see page 49 for details. PCB mount contacts are available, please contact Technical Sales for details.



CONTACT VARIANTS

FACE VIEW OF MALE OR REAR VIEW OF FEMALE

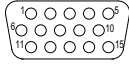

DD 15

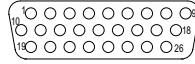

DD 26

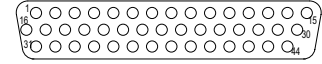

DD 44

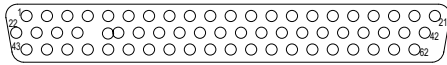

DD 62

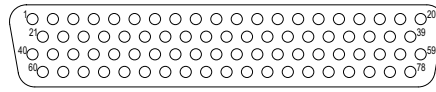

DD 78

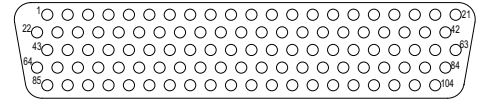

DD 104

STANDARD SHELL ASSEMBLY

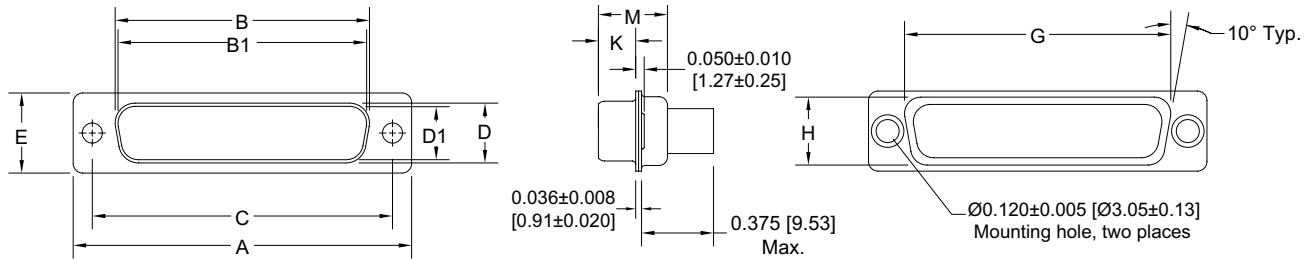

OPTIONAL SHELL ASSEMBLY [0, 02]

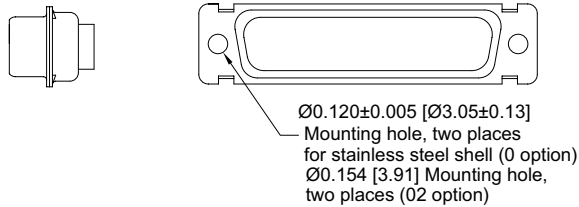

OPTIONAL SHELL ASSEMBLY WITH UNIVERSAL FLOAT MOUNTS [F]

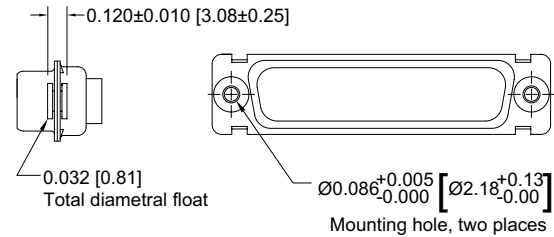

CONNECTOR VARIANT SIZES	A ±0.015 [0.38]	B ±0.005 [0.13]	B1 ±0.005 [0.13]	C ±0.005 [0.13]	D ±0.005 [0.13]	D1 ±0.005 [0.13]	E ±0.015 [0.38]	G ±0.010 [0.25]	H ±0.010 [0.25]	K ±0.005 [0.13]	M ±0.010 [0.25]
DD 15 M	1.213 [30.81]		0.666 [16.92]	0.984 [24.99]		0.329 [8.36]	0.494 [12.55]	0.759 [19.28]	0.422 [10.72]	0.233 [5.92]	0.422 [10.72]
DD 15 F	1.213 [30.81]	0.643 [16.33]		0.984 [24.99]	0.311 [7.90]		0.494 [12.55]	0.759 [19.28]	0.422 [10.72]	0.243 [6.17]	0.429 [10.90]
DD 26 M	1.541 [39.14]		0.994 [25.25]	1.312 [33.32]		0.329 [8.36]	0.494 [12.55]	1.083 [27.51]	0.422 [10.72]	0.233 [5.92]	0.422 [10.72]
DD 26 F	1.541 [39.14]	0.971 [24.66]		1.312 [33.32]	0.311 [7.90]		0.494 [12.55]	1.083 [27.51]	0.422 [10.72]	0.243 [6.17]	0.429 [10.90]
DD 44 M	2.088 [53.04]		1.534 [38.96]	1.852 [47.04]		0.329 [8.36]	0.494 [12.55]	1.625 [41.28]	0.422 [10.72]	0.230 [5.84]	0.426 [10.82]
DD 44 F	2.088 [53.04]	1.511 [38.38]		1.852 [47.04]	0.311 [7.90]		0.494 [12.55]	1.625 [41.28]	0.422 [10.72]	0.243 [6.17]	0.429 [10.90]
DD 62 M	2.729 [69.32]		2.182 [55.42]	2.500 [63.50]		0.329 [8.36]	0.494 [12.55]	2.272 [57.71]	0.422 [10.72]	0.230 [5.84]	0.426 [10.82]
DD 62 F	2.729 [69.32]	2.159 [54.84]		2.500 [63.50]	0.311 [7.90]		0.494 [12.55]	2.272 [57.71]	0.422 [10.72]	0.243 [6.17]	0.429 [10.90]
DD 78 M	2.635 [66.93]		2.079 [52.81]	2.406 [61.11]		0.441 [11.20]	0.605 [15.37]	2.178 [55.32]	0.534 [13.56]	0.230 [5.84]	0.426 [10.82]
DD 78 F	2.635 [66.93]	2.064 [52.43]		2.406 [61.11]	0.423 [10.74]		0.605 [15.37]	2.178 [55.32]	0.534 [13.56]	0.243 [6.17]	0.429 [10.90]
DD 104 M	2.729 [69.32]		2.212 [56.18]	2.500 [63.50]		0.503 [12.78]	0.668 [16.97]	2.302 [58.47]	0.596 [15.14]	0.230 [5.84]	0.426 [10.82]
DD 104 F	2.729 [69.32]	2.189 [55.60]		2.500 [63.50]	0.485 [12.32]		0.668 [16.97]	2.302 [58.47]	0.596 [15.14]	0.243 [6.17]	0.429 [10.90]



Positronic Industries
connectpositronic.com

MILITARY QUALITY, REMOVABLE CONTACT, HIGH DENSITY SUBMINIATURE-D CONNECTORS

D-Sub

FOR MILITARY AND SEVERE INDUSTRIAL ENVIRONMENTAL APPLICATIONS

CRIMP CONTACTS CLOSED CRIMP BARREL

FEMALE CONTACT "CLOSED ENTRY" DESIGN

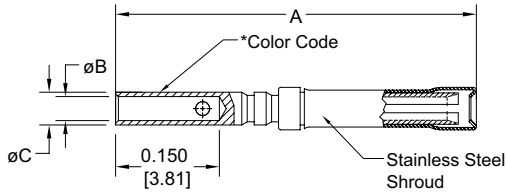

Part Number: FC8122D

MALE CONTACT

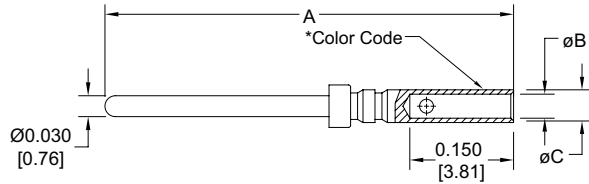

Part Number: MC8022D

Crimp contacts may be supplied kitted with connector or ordered separately.

PART NUMBER	WIRE SIZE AWG/[mm ²]	A	ØB	ØC
FC8022D	22 / 24 / 26 / 28 / 30 [0.3/0.25/0.12/0.08/0.05]	0.518 [13.16]	0.035 [0.89]	0.047 [1.19]
*M39029/57-354	22 / 24 / 26 / 28 [0.3/0.25/0.12/0.08]	0.518 [13.16]	0.035 [0.89]	0.047 [1.19]

Material - Lead nickel copper.

Plating - Gold flash over nickel or 0.000050 inch [1.27µ] gold over copper for military specification contacts.

*Color Code - ORANGE/GREEN/YELLOW for military specification contacts.

PART NUMBER	WIRE SIZE AWG/[mm ²]	A	ØB	ØC
MC8022D	22 / 24 / 26 / 28 / 30 [0.3/0.25/0.12/0.08/0.05]	0.531 [13.49]	0.035 [0.89]	0.047 [1.19]
*M39029/58-360	22 / 24 / 26 / 28 [0.3/0.25/0.12/0.08]	0.531 [13.49]	0.035 [0.89]	0.047 [1.19]

Material - Brass.

Plating - Gold flash over nickel or 0.000050 inch [1.27µ] gold over copper for military specification contacts.

*Color Code - ORANGE/BLUE/BLACK for military specification contacts.

For contact crimp tool information see page 54.

Additional plating options available by adding suffix to part number

add -14 for 0.000030 [0.76 microns] gold over nickel

Example: FC8022D-14

add -50 for 0.000050 [1.27 microns] gold over copper

Example: MC8022D-50

FEMALE CONTACT

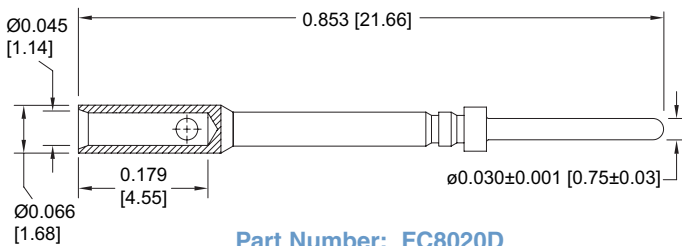

Part Number: FC8020D

MALE CONTACT

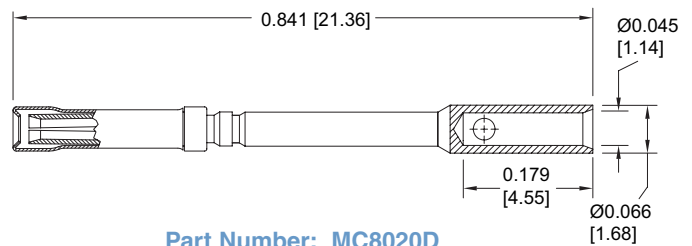

Part Number: MC8020D

Crimp area extends above connector molding.

Crimp contacts may be supplied kitted with connector or ordered separately.

PART NUMBER	WIRE SIZE AWG/[mm ²]	A	ØB	ØC
FC8020D	20 [0.5] max	0.852 [21.64]	0.045 [1.14]	0.066 [1.68]

Material - Phosphor bronze

Plating - Gold flash over nickel

PART NUMBER	WIRE SIZE AWG/[mm ²]	A	ØB	ØC
MC8020D	20 [0.5] max	0.853 [21.66]	0.045 [1.14]	0.066 [1.68]

Material - Brass

Plating - Gold flash over nickel

Additional plating options available by adding suffix to part number

add -14 for 0.000030 [0.76 microns] gold over nickel

Example: FC8120D-14 or MC8020D-14

Thermocouple contacts are available, see page 49

DD SERIES



REELS FOR AUTOMATIC PNEUMATIC CRIMP TOOLS

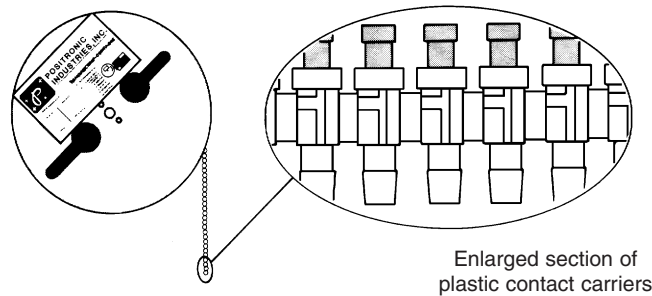

Contacts may be supplied in plastic carriers, packaged in reels holding 2,000 contacts for use with the automatic pneumatic crimp tools, catalog part number 9550-1. The same type carrier is used for both male and female contacts.

All male and female crimp contacts can be ordered in reels by adding letter "R" after the contact part number, such as MC8022DR for a male contact and FC8022DR for a female contact.

SOLDER CUP CONTACTS

FEMALE CONTACT
"CLOSED ENTRY" DESIGN

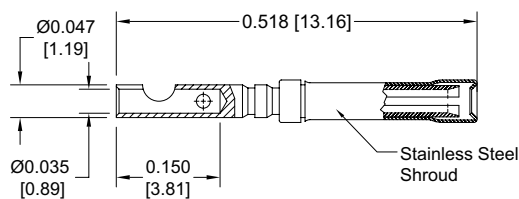

Part Number: FS8022D

Material - Phosphor bronze.
Plating - Gold flash over nickel.

MALE CONTACT

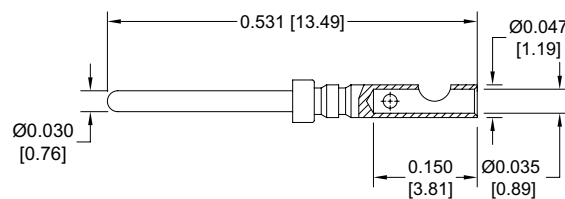

Part Number: MS8022D

Material - Brass.
Plating - Gold flash over nickel.

Solder contacts may be supplied kitted with connector or ordered separately.



SIZE 22 CRIMP THERMOCOUPLE CONTACTS

22 AWG [0.3mm²]

MALE CONTACT

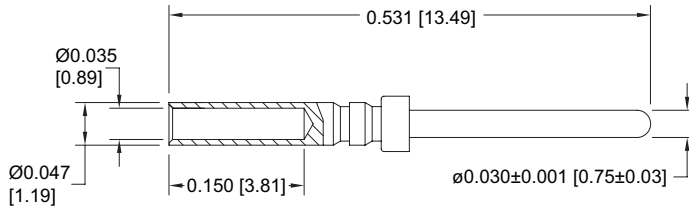

FEMALE CONTACT

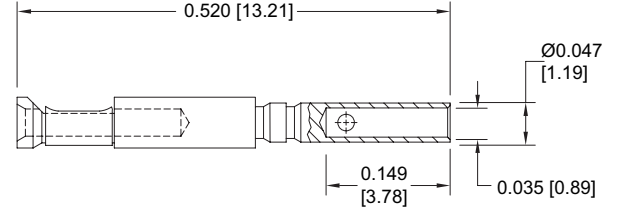

TYPE	MATERIAL	MALE PART NUMBER	FEMALE PART NUMBER	COLOR CODE	WIRE SIZE AWG [mm ²]
K	CHROMEL (+)	MC8022DCH	FC8022DCH	WHITE	22 / 24 / 26 [0.3 / 0.25 / 0.12]
	ALUMEL (-)	MC8022DAL	FC8022DAL	GREEN	22 / 24 / 26 [0.3 / 0.25 / 0.12]
T	COPPER (+)	MC8022DCU	FC8022DCU	RED	22 / 24 / 26 [0.3 / 0.25 / 0.12]
	CONSTANTAN (-)	MC8022DCO	FC8022DCO	YELLOW	22 / 24 / 26 [0.3 / 0.25 / 0.12]
E	CHROMEL (+)	MC8022DCH	FC8022DCH	WHITE	22 / 24 / 26 [0.3 / 0.25 / 0.12]
	CONSTANTAN (-)	MC8022DCO	FC8022DCO	YELLOW	22 / 24 / 26 [0.3 / 0.25 / 0.12]

Chromel® and Alumel® are registered trademarks of Hoskins Manufacturing Company

For more information on the availability of Type J thermocouple contacts, please contact Technical Sales.

For more information about thermocouple contacts with PCB solder termination, please contact Technical Sales.

See page 54 for Crimp Tool information.





STRAIGHT PRINTED BOARD MOUNT CONTACTS

FEMALE CONTACT
"CLOSED ENTRY" DESIGN

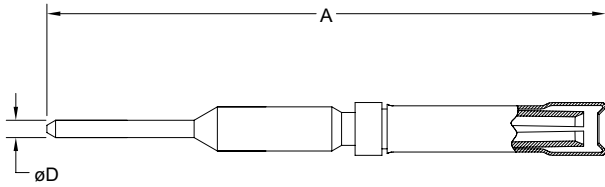

MALE CONTACT

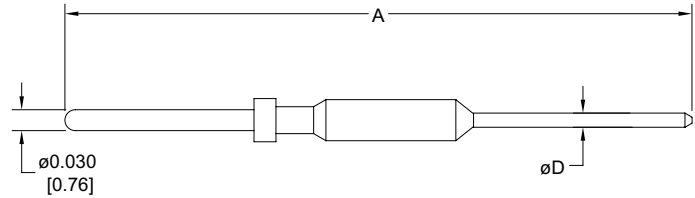

Straight printed board mount contacts are supplied in connector.

CODE NUMBER	L	ØD	A
3	0.150 [3.81]	0.020 [0.51]	0.725 [18.42]
32	0.300 [7.62]	0.020 [0.51]	0.865 [21.97]

For straight printed board mount contacts specify code no. in step 4 of ordering information.

CODE NUMBER	L	ØD	A
3	0.150 [3.81]	0.020 [0.51]	0.737 [18.72]
32	0.300 [7.62]	0.020 [0.51]	0.877 [22.28]

Material – Phosphor bronze or brass.
Plating – Gold flash over nickel.

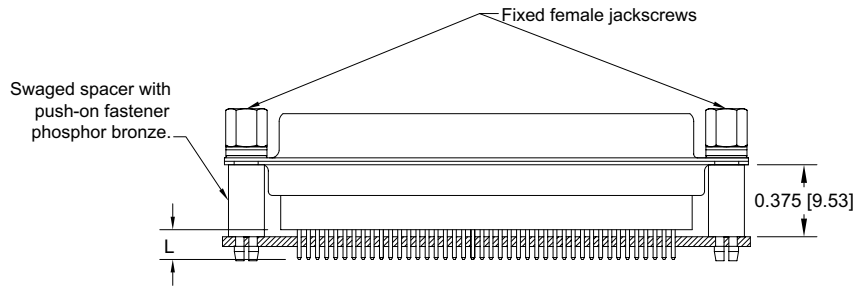

Typical Part Number: DD62F3S60T2X

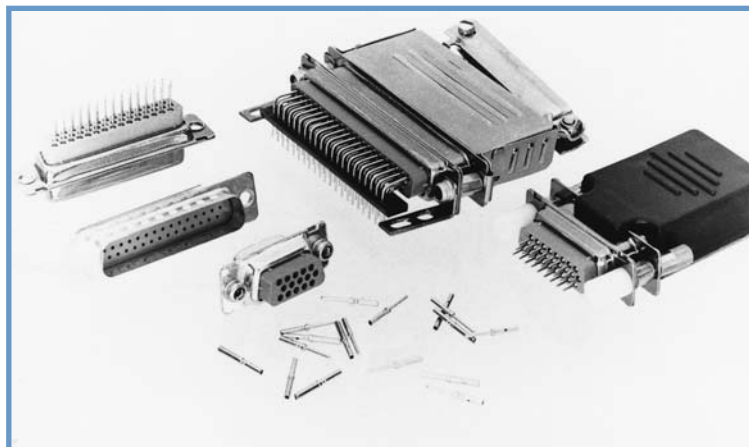



Positronic Industries
connectpositronic.com

MILITARY QUALITY, REMOVABLE CONTACT, HIGH DENSITY SUBMINIATURE-D CONNECTORS

FOR MILITARY AND SEVERE INDUSTRIAL ENVIRONMENTAL APPLICATIONS

D-Sub

DD SERIES

90° PRINTED BOARD MOUNT CONNECTOR CODE 4, 0.450 [11.43] CONTACT EXTENSION

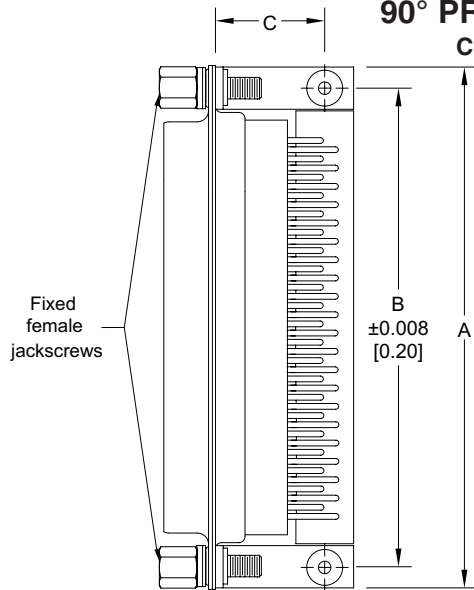

DD**4R7000 0.450 [11.43] CONTACT EXTENSION				
PART NUMBER	A	B	C	D
DD15*4R7***	1.204 [30.58]	0.984 [24.99]	0.528 [13.41]	0.450 [11.43]
DD26*4R7***	1.532 [38.91]	1.312 [33.32]	0.528 [13.41]	0.450 [11.43]
DD44*4R7***	2.072 [52.63]	1.852 [47.04]	0.528 [13.41]	0.450 [11.43]
DD62*4R7***	2.720 [69.09]	2.500 [63.50]	0.528 [13.41]	0.450 [11.43]
DD78*4R7***	2.626 [66.70]	2.406 [61.11]	0.573 [14.55]	0.450 [11.43]

Specify code 4
in step 4 of
ordering information

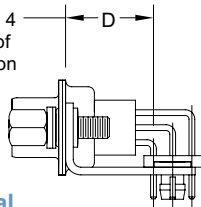

Typical
Part Number:
DD44M4R7NT2X

0.078 [1.98] Typ.
0.078 [1.98] Typ.

Numbering shown is rear view
of male and face view of female.

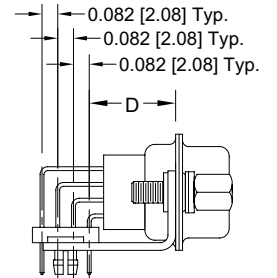
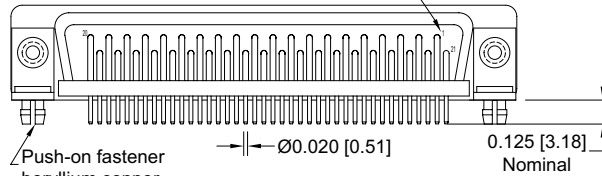

Typical Part Number:
DD78M4R7NT2X

90° PRINTED BOARD MOUNT CONNECTOR, SIZE 104 CODE 4, 0.450 [11.43] CONTACT EXTENSION

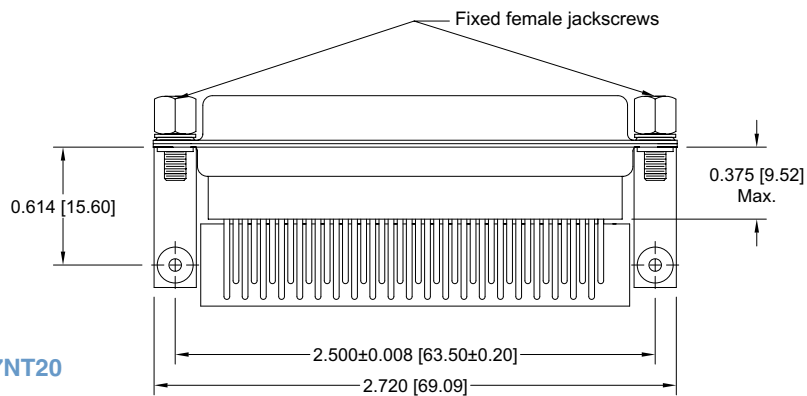

Typical Part Number: DD104M4R7NT20

Specify code 4
in step 4 of
ordering information

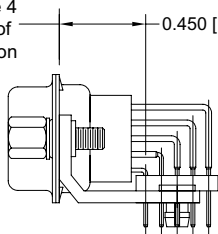

0.082 [2.08]
Typ.

Numbering
shown is rear view
of male and face view
of female

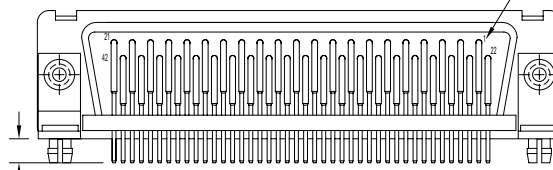

0.125 [3.17]
Nominal

Push-on fastener
beryllium copper



90° AND STRAIGHT PRINTED BOARD
CONTACT HOLE PATTERN

Mount connector with mating face positioned to follow direction of arrows.

DD15 MALE

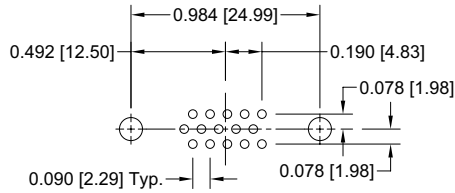

DD15 FEMALE

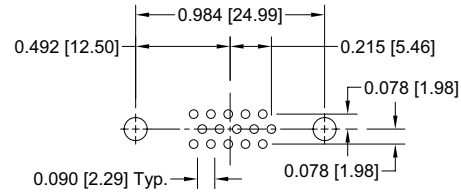

DD 26 MALE

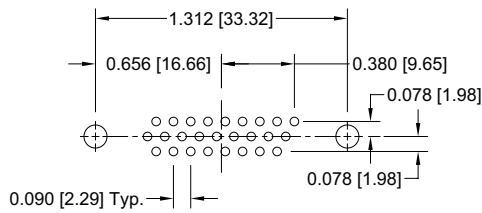

DD 26 FEMALE

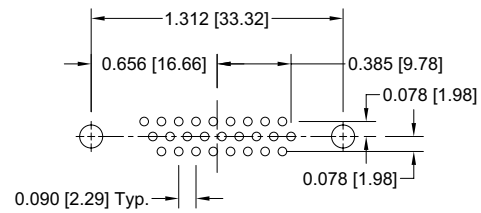

DD44 MALE

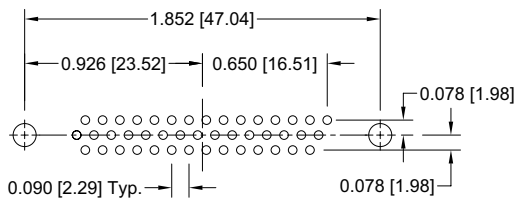

DD44 FEMALE

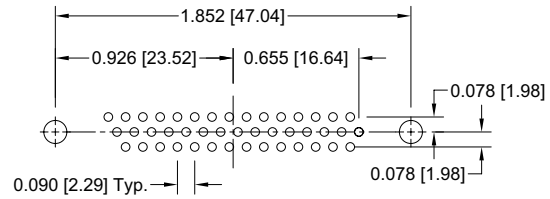

DD62 MALE

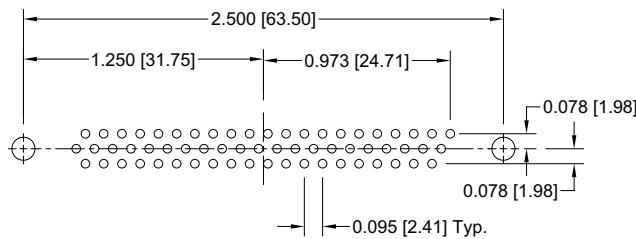

DD62 FEMALE

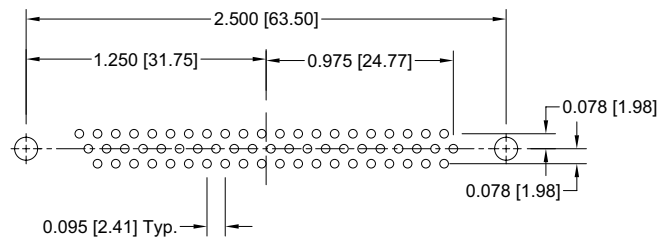

DD78 MALE

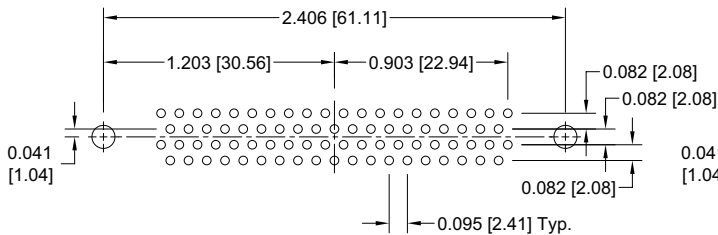

DD78 FEMALE

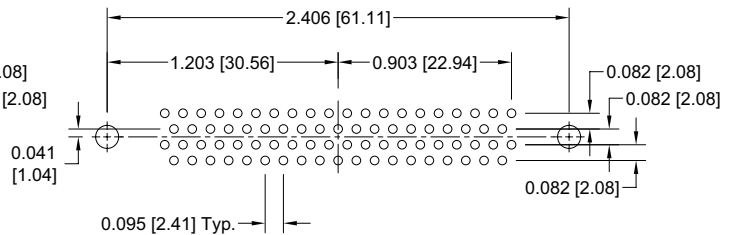

DD104 MALE

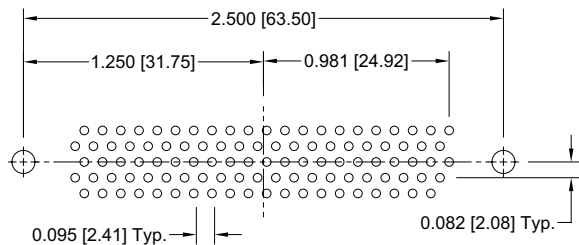

DD104 FEMALE

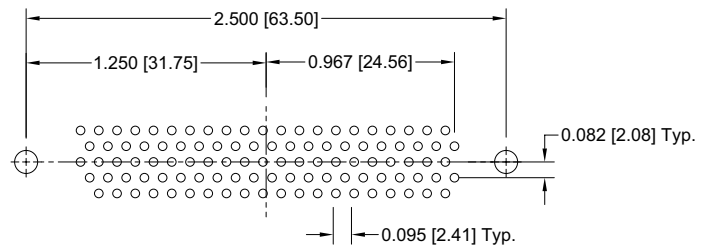

Suggest 0.035 [0.89] Ø hole for contact termination positions.
Suggest 0.123 ±0.003 [3.12 ±0.08] Ø hole for mounting connector with push-on fasteners.

DIMENSIONS ARE IN INCHES [MILLIMETERS].
ALL DIMENSIONS ARE SUBJECT TO CHANGE.



CRIMPING INFORMATION FOR DD AND ODD SERIES CRIMP CONTACTS

USE INDICATED POSITRONIC TOOLS FOR BEST RESULTS

Step 1: Strip wire to indicated length.

- Take Care Not To:
- Damage or remove strands.
 - Untwist or overtwist strands.
 - Leave insulation particles on strands.
 - Damage insulation.

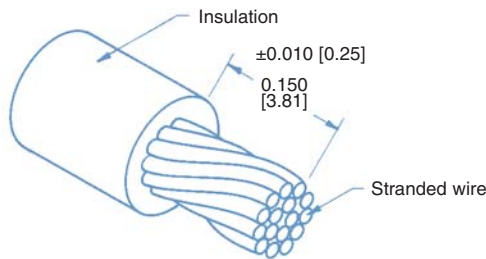

Correctly Stripped Wire

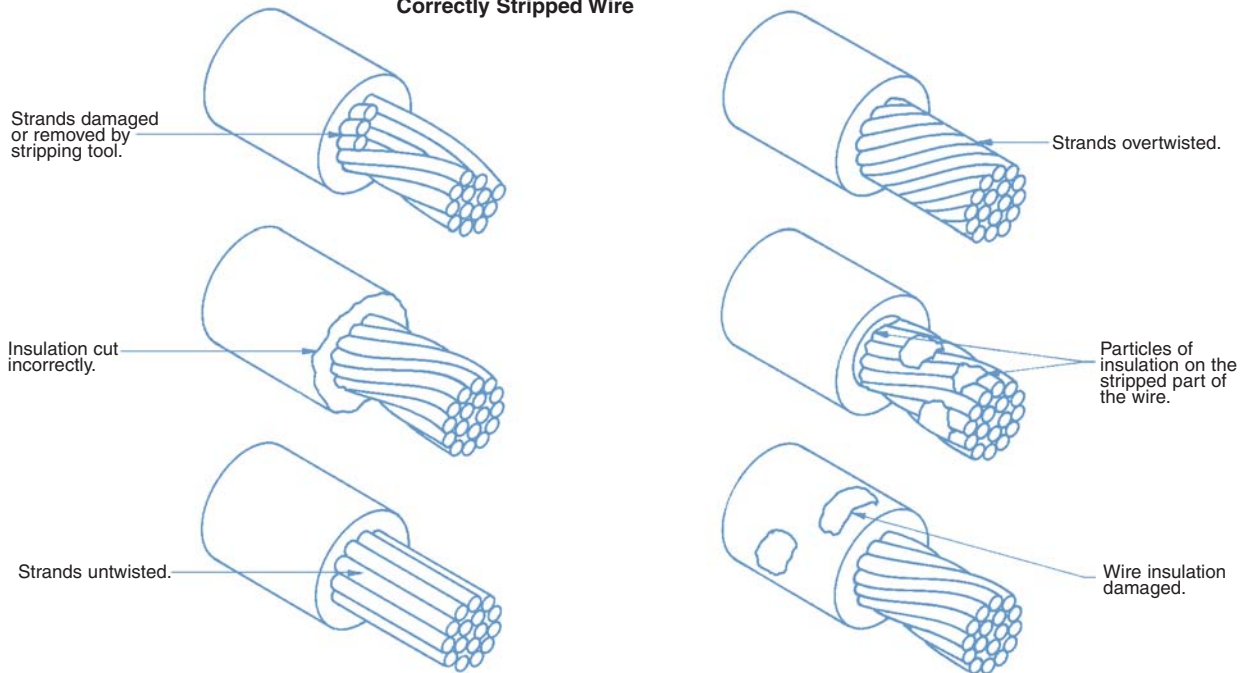

Examples of Stripping Faults

Step 2: Crimp wire to contact.

- For Hand Crimp Tool:
- Place contact into crimping tool.
 - Insert wire into contact.
 - Center contact by slowly closing the crimping tool until the crimp indenters make contact with the crimp barrel.
 - Complete the cycle of the crimping tool in one smooth motion.
 - Remove the crimped contact.

- For Automatic Pneumatic Crimp Tool:
- Insert the wire into the contact, positioned in the crimp tool by the plastic carrier.
 - Depress the activating device of the crimping tool to start the crimping cycle.
 - Remove the crimped contact.



CRIMPING INFORMATION FOR DD AND ODD CRIMP CONTACTS

Step 3: Inspect the crimp.

- For All Tools:**
- Strands to be visible through the inspection hole.
 - Strands not to be visible beyond the insulation support.
 - Crimped contact to meet recommended conductor tensile force shown in chart.
 - Check for peeled gold and bent contacts.

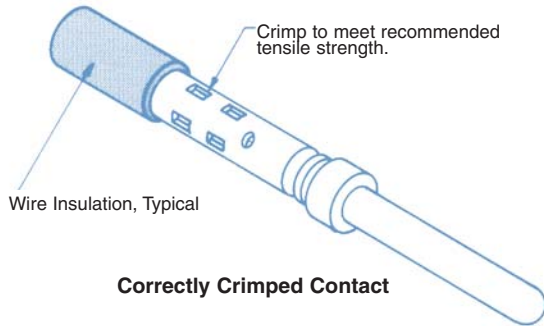

Cross Section of Correctly Crimped Contact

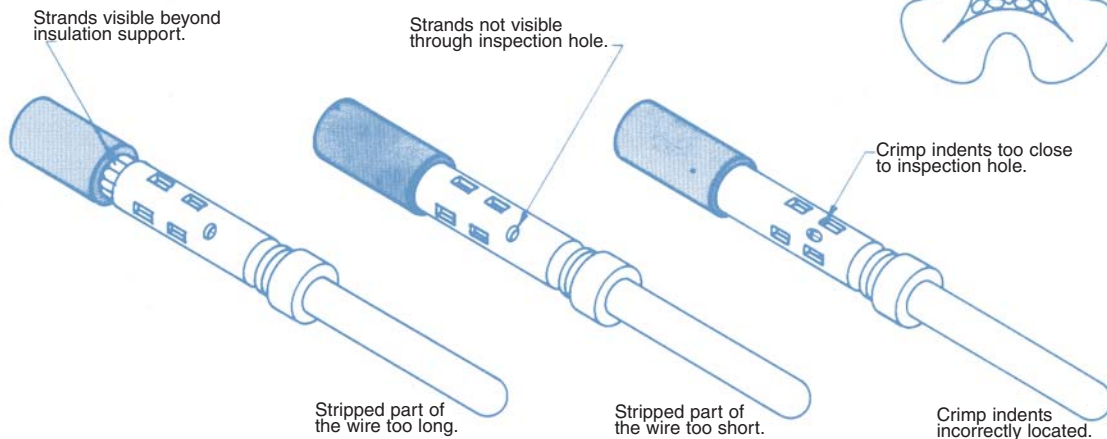
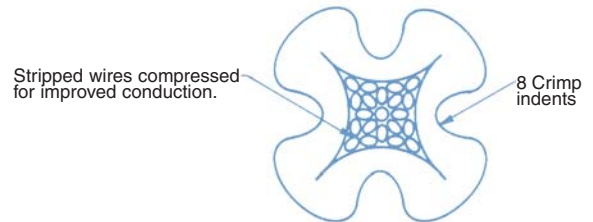

Examples of Crimping Faults

Positronic Recommended Conductor Tensile Strength					
WIRE SIZE AWG/[mm ²]	.22 [0.3]	.24 [0.25]	.26 [0.12]	.28 [0.08]	.30 [0.05]
AXIAL LOAD POUNDS/[N]	.12 [53]	.8 [36]	.5 [22]	.3 [13]	.15 [6.7]

Conductor tensile strength values are derived using silver-tin plated copper wires.

Values may change depending upon what type of wire is used.

Positronic recommended tools for DD series contacts. For more information see contact crimp tools and accessories page.		
CRIMP TOOLS	POSITIONERS FOR FC8022D	POSITIONERS FOR MC8022D
9507 HAND CRIMP TOOL	9502-3	9502-4
9550-1 AUTOMATIC PNEUMATIC CRIMP TOOL	Supplied in reels	Supplied in reels



Positronic Industries
connectpositronic.com

MILITARY QUALITY, REMOVABLE CONTACT, HIGH DENSITY SUBMINIATURE-D CONNECTORS

FOR MILITARY AND SEVERE INDUSTRIAL ENVIRONMENTAL APPLICATIONS

D-Sub

AUTOMATIC CRIMP TOOL, PNEUMATICALLY ACTUATED Part No. 9550-1

This fast cycling automatic crimp tool produces an 8 indent crimp on wire sizes 20 AWG [0.5mm²] through 32 AWG [0.03mm²]. DD Series contacts must be ordered on reels.

To order, specify part number 9550-1. Foot control valve is supplied as a standard accessory.



MINIATURE STEP ADJUSTABLE TOOL (M22520/2-01) Part No. 9507

This miniature step adjustable hand crimping tool produces an 8 indent crimp configuration and will crimp wire sizes 20 AWG [0.5mm²] through 32 AWG [0.03mm²].

To crimp FC8022D contacts, order contact positioner 9502-3. To crimp MC8022D contacts, order contact positioner 9502-4. To crimp MC8020D and FC8020D contacts, consult Technical Sales for contact positioners. Each positioner is equipped with a data plate which gives the correct crimp-depth setting for each wire size, and must be used with 9507 tool frame for best results when crimping Densi-D Series contacts.



INSERTION/REMOVAL TOOL (M81969/1-04) Part No. 4811-2

One end of this tool is used to insert contacts into Densi-D Series connectors. The other end is used to extract contacts. This is accomplished by sliding the extraction tip down the wire into the connector until it bottoms against the contact. A slight rotation while pushing will release the contacts, which are then extracted by simultaneously pulling on the wire.

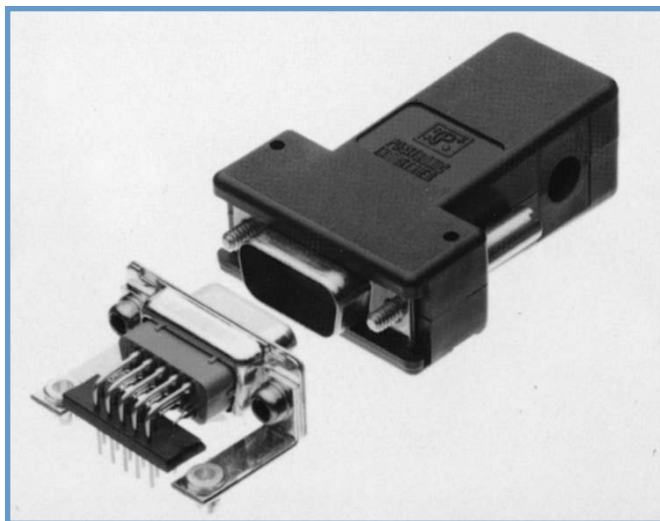

DD SERIES



ORDERING INFORMATION - CODE NUMBERING SYSTEM

Specify Complete Connector By Selecting An Option From Step 1 Through 8

STEP	1	2	3	4	5	6	7	8	9
EXAMPLE	DD	62	F	4	R7	N	T6	S	—

STEP 1 - BASIC SERIES

DD Series

STEP 2 - CONNECTOR VARIANTS

15, 26, 44, 62, 78, 104

STEP 3 - CONNECTOR GENDER

M - Male
F - Female

STEP 4 - CONTACT TERMINATION TYPE

- 0 - Ordered Without Contacts.
- 1 - Crimp, 22 AWG–30 AWG [0.3mm²–0.05mm²].
- 2 - Solder cup, 22 AWG–30 AWG [0.3mm²–0.05mm²].
- 3 - Solder, Straight Printed Board Mount with 0.150 [3.81] Tail Length.
- 32 - Solder, Straight Printed Board Mount with 0.300 [7.62] Tail Length.
- 4 - Solder, 90° Printed Board Mount with 0.450 [11.43] Contact Extension.

*STEP 5 - MOUNTING STYLE

- 0 - Mounting Hole, 0.120 [3.05] Ø.
- 02 - Mounting Hole, 0.154 [3.91] Ø.
- B3 - Bracket, Mounting, 90° Metal with Cross Bar.
- B8 - Bracket, Mounting, 90° Plastic with Cross Bar.
- F - Float Mounts, Universal.
- P - Threaded Post, Brass, 0.375 [9.53] Length.
- P2 - Threaded Post, Nylon, 0.375 [9.53] Length.
- R2 - Bracket, Mounting, 90° Metal, Swaged to Connector with 4-40 Thread Fixed Female Jackscrews with Cross Bar.
- R6 - Bracket, Mounting, 90° Metal, Swaged to Connector with 0.120 [3.05] Ø Mounting Hole with Cross Bar.
- R7 - Bracket, Mounting, 90° Metal, Swaged to Connector with 4-40 Threads with Cross Bar.
- R8 - Bracket, Mounting, 90° Metal, Swaged to Connector with 4-40 Locknut with Cross Bar.
- S - Swaged Spacer, 4-40 Threads, 0.375 [9.53] Length.
- S2 - Swaged Spacer, 4-40 Threads, 0.125 [3.18] Length.
- S5 - Swaged Locknut, 4-40 Threads.
- S6 - Swaged Spacer with Push-on Fasteners, 4-40 Threads, 0.375 [9.53] Length.
- S7 - Swaged Spacer with Push-on Fastener for use with Ferrite Inductor, 4-40 Threads, 0.515 [13.08] Length.

STEP 9 - SPECIAL OPTIONS

CONTACT TECHNICAL SALES FOR ORDERING DETAILS OF THE FOLLOWING:

Other Special Requirements.
Straight and Right Angle Thermocouple
PCB mount contacts

STEP 8 - SHELL OPTIONS

- 0 - Zinc Plated with Dichromate Seal.
- S - Stainless Steel.
- X - Tin Plated.
- Z - Tin Plated and Dimpled (male connectors only).
- C - Cadmium with Dichromate Seal.

*STEP 7 - LOCKING AND POLARIZING SYSTEMS

- 0 - None.
- V3 - Lock Tab, connector front panel mounted.
- V5 - Lock Tab, connector rear panel mounted.
- VL - Lock Lever, used with Hoods only.
- T - Fixed Female Jackscrews.
- T2 - Fixed Female Jackscrews.
- T6 - Fixed Male and Female Polarized Jackscrews.
- E - Rotating Male Jackscrews.
- E2 - Rotating Male Screw Locks.
- E3 - Rotating Male with internal hex for 3/32 hex drives
- E6 - Rotating Male and Female Polarized Jackscrews.

*STEP 6 - HOODS AND PUSH-ON FASTENERS

- 0 - None.
- J - Hood, Top Opening, Plastic.
- L - Hood, Side Opening, Plastic.
- Y - Hood, Top Opening, Plastic with Rotating Male Jackscrews. Available in size 78 and 104 only.
- Y6 - Hood, Top Opening, Plastic with Rotating Male and Female Polarized Jackscrews. Available in size 78 and 104 only.
- Z - Hood, Top or Side Opening, Robust and Extended Height, Composite and Plastic with Rotating Male Jackscrews. Available in size 15, 26, 44, 62, and 78 only.
- H - Hood, Top Opening, Metal. Available in size 26, 44, 62, and 78 only.
- G - Hood, EMI/RFI, Metal.
- W - Hood, Top or Side Opening, Plastic. Available in size 15, 26, and 44 only.
- N - Push-on Fastener, for 90° Mounting Brackets.
- **F - Ferrite Inductor



Contact Technical Sales for details.

*For additional information on accessories listed in steps 5, 6 and 7, see Accessory Catalog.

**Ferrite inductor is available on contact type 32 only.