

DESCRIPTION

These families of hyperabrupt junction RF varactor diodes feature computer controlled grown junction epitaxy which provides extraordinary consistency and the highest Q available in a 22 Volt hyperabrupt varactor. These series give the designer a full capacitance range of 10 to 500 pF at 3 or 4 volts of bias, depending on product series. They allow octave tuning of LC tanks through 500 MHz. With a reduced 1.5 to 1 frequency ratio, straight-line-frequency tuning over a 3 to 8 volt tuning range is possible. Ultrahigh Q and excellent large signal handling capabilities, along with a 2 to 1 capacitance ratio, is obtained by tuning from 9 to 20 volts of reverse bias. Linear, wide deviation tuning of VCXO/TCXO'S and frequency modulators also results when these diodes are tuned over a 3 to 8 volt bias range.

Closely matched sets of all HF-VHF diodes are available along with "A" suffix versions having $\pm 5\%$ capacitance tolerance at 3 or 4 volts of reverse bias depending on series selected.

APPLICATIONS

These families of hyperabrupt varactors are ideal for wide bandwidth VCOs. They also provide excellent performance in frequency modulators, voltage variable filters, analog phase shifters, TCXOs and VCXOs.

KEY FEATURES

- Available as packaged devices or as chips for hybrid applications
- Octave Tuning Range
- Ultrahigh Q
- Available with 5% Tolerance C_T

APPLICATIONS/BENEFITS

- Values cover the entire HF / VHF / UHF spectrum;
- Highest Q / lowest VCO phase noise
- Tough MIL-Spec SiO₂ passivation
- Dozens of package outlines available

**ABSOLUTE MAXIMUM RATINGS AT 25° C
(UNLESS OTHERWISE SPECIFIED)**

Rating	Symbol	Value	Unit
Maximum Working Voltage	V_R	22	V
Storage Temperature	T_{STG}	-65 to +150	°C
Operating Temperature	T_{OP}	-55 to +150	°C

IMPORTANT: For the most current data, consult our website: www.MICROSEMI.com
 Specifications are subject to change. Consult factory for the latest information.



These devices are ESD sensitive and must be handled using ESD precautions.

¹ Unless otherwise specified, these products are supplied with Gold terminations suitable for RoHS compliant assembly.

HF / VHF – HYPERABRUPT VARACTORS
ELECTRICAL PARAMETERS @ 25°C (unless otherwise specified)

MODEL NUMBER	C _T (pF) f = 1 MHz Min / Typ / Max			Capacitance Ratio Typ C(-4V) / C(-20V)	Quality Factor ¹ Min/Typ Q @ -4V f = 50MHz	I _R Typ/Max V _R = 20V (nA)
	V _R = 4V	V _R = 8V	V _R = 20V			
KV2001	18 / 20 / 22	7.5 / 8.5 / 10.5	3.1 / 3.5 / 3.9	5.8	160 / 220	15 / 100
KV2201	45 / 50 / 55	18 / 20 / 25	7.3 / 8.0 / 9.2	6.3	125 / 165	20 / 100
KV2301	100 / 110 / 120	39 / 45 / 55	15 / 17 / 19	6.6	80 / 110	30 / 100
KV2401	140 / 155 / 170	55 / 65 / 80	22.5 / 25 / 28	6.2	70 / 90	50 / 500
KV2501	180 / 200 / 220	70 / 85 / 105	29 / 32 / 36	6.3	60 / 80	70 / 500
KV2601	270 / 300 / 330	110 / 125 / 155	42.5 / 48 / 53.5	6.4	40 / 50	100 / 1000
KV2701	450 / 500 / 550	175 / 195 / 225	66 / 75 / 83	6.8	30 / 40	150 / 1000

UHF – HYPERABRUPT VARACTORS
ELECTRICAL PARAMETERS @ 25°C (unless otherwise specified)

MODEL NUMBER	C _T (pF) f = 1 MHz Min / Typ / Max			CAPACITANCE RATIO Typ C(-3V) / C(-20V)	QUALITY FACTOR ¹ Min/Typ Q @ -3V f = 50MHz	I _R Typ/Max V _R = 20V (nA)
	V _R = 3V	V _R = 8V	V _R = 20V			
KV2101	10.5 / 11.5 / 12.5	4.3 / 5.0 / 5.7	2.0 / 2.15 / 2.3	5.4	300 / 350	10 / 100
KV2801	25 / 28 / 31	10 / 12 / 13.5	4.5 / 4.8 / 5.1	5.9	200 / 250	20 / 100

1. Q is determined at V_R = 4V, f = 50 MHz by $Q = 1/(2\pi f R_s C_j)$

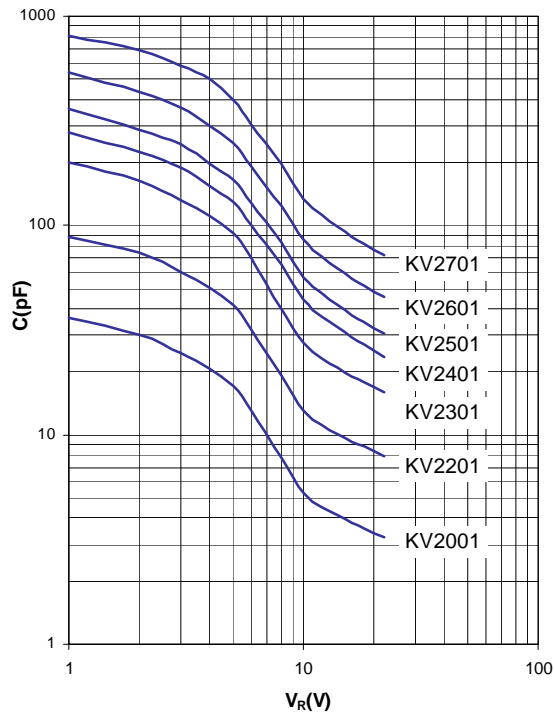
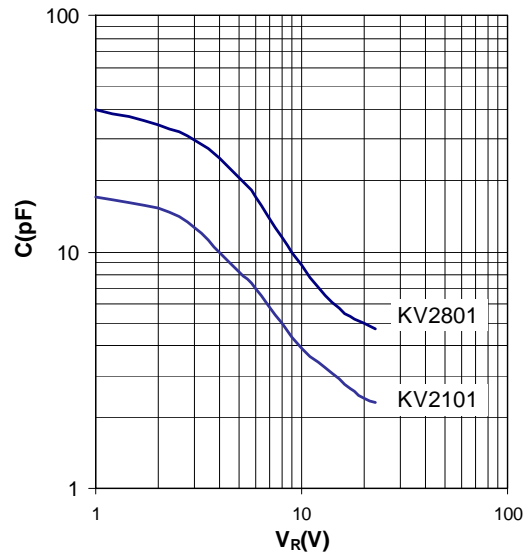
C-V (HF-VHF HYPERABRUPT)
C-V (UHF HYPERABRUPT)
KV2001-KV2701 C-V Curves

KV2801 / KV2101 C-V Curves

TYPICAL PACKAGE STYLES

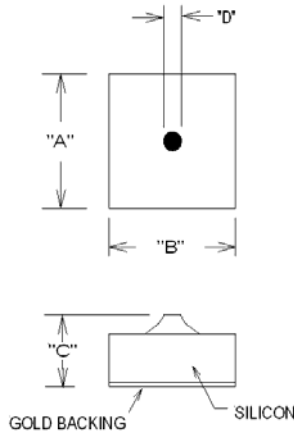
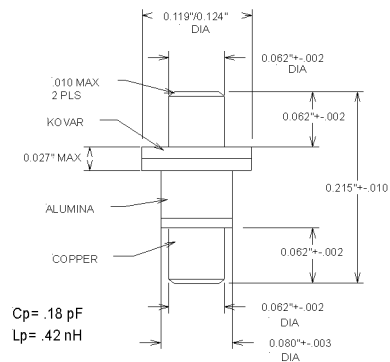
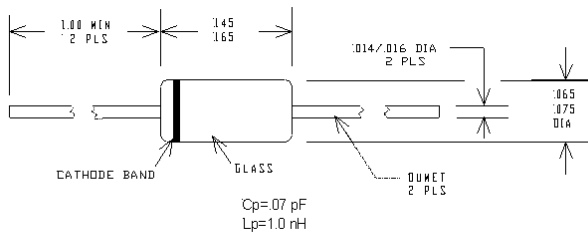
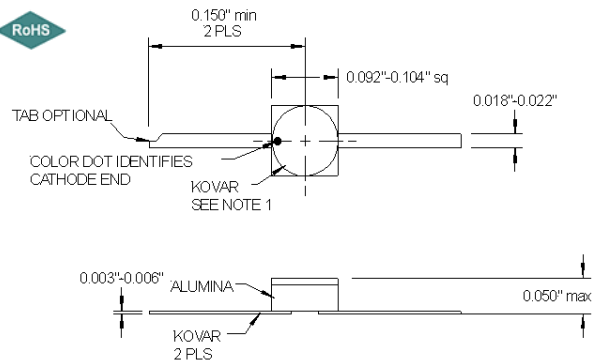
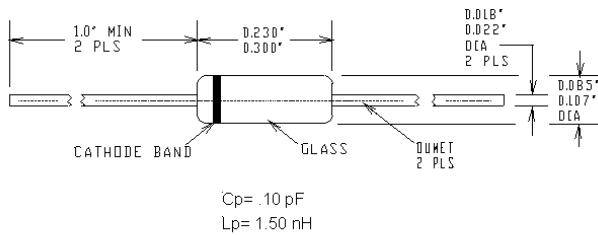
Microsemi offers a variety of package styles to meet specific application requirements. Some limitations apply. Consult factory for details.

PACKAGE STYLE 00

PACKAGE STYE 30

PACKAGE STYLE 15

PACKAGE STYLE 17

PACKAGE STYLE 11

NOTES

The standard 11 and 15 package styles are not RoHS compliant. Consult Factory for RoHS complaint options.