

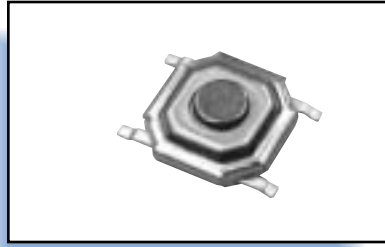

FSM Series - Page E3

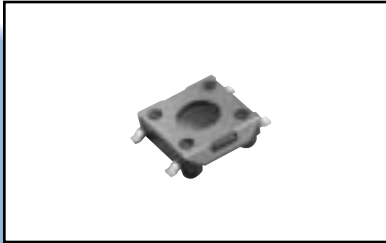

4.9mm Series - Page E11



Low Profile Series - Page E12

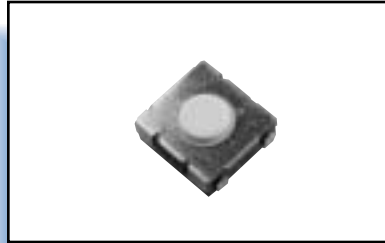

High Life Tactile - Page E12

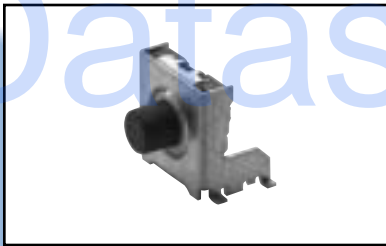

Sealed Series - Page E27

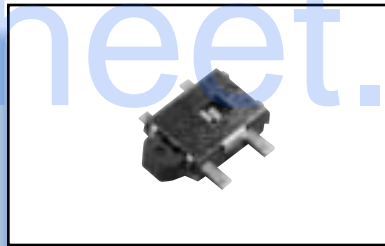

Side Actuated - Page E29

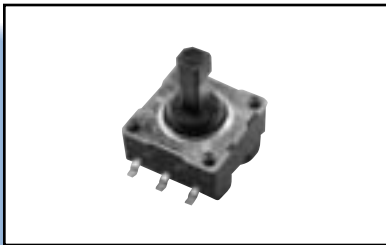

Multi-Directional Actuation - Page E30

Tactile

E

Tactile Switches

Tactile Switches Part Number Index

FSME3	FSM4JAE5	FSMRA 8JLE7
FSM100E16	FSM4JAAE5	FSMRACDE8
FSM100AE16	FSM4JARTE6	FSMRACDAE8
FSM101E16	FSM4JLE5	FSMSME9
FSM102E17	FSM4JRTE6	FSMSMTRE9
FSM102AE17	FSM4JSMAE10	1571217E18
FSM103E17	FSM4JSMAA ...E10	1571218E19
FSM104E17	FSM4JSMAATR E10	1571219E20
FSM10JE5	FSM4JSMATR ...E10	1571220E21
FSM10JAE5	FSM4LPE15	1571262E29
FSM10JAAE5	FSM4LPTRE15	1571294E22
FSM10JLE5	FSM5JE5	1571295E24
FSM11JE5	FSM5JAE5	1571296E23
FSM11JAE5	FSM5JAAE5	1571297E26
FSM11JAAE5	FSM5JLE5	1571298E25
FSM11JLE5	FSM6JE5	1571300E27
FSM12JE5	FSM6JAE5	1571407E28
FSM12JAE5	FSM6JAAE5	1571514E30
FSM12JAAE5	FSM6JARTE6	1571515E30
FSM12JLE5	FSM6JLE5	1571625E12
FSM13JE5	FSM6JRTE6	1571626E13
FSM13JAE5	FSM6JSMAE10	1571636E14
FSM13JAAE5	FSM6JSMAA ...E10	
FSM13JLE5	FSM6JSMAATR E10	
FSM14JE5	FSM6JSMATR ...E10	
FSM14JAE5	FSM7JE5	
FSM14JAAE5	FSM7JAE5	
FSM14JLE5	FSM7JAAE5	
FSM14JRTE6	FSM7JLE5	
FSM15JE5	FSM8JE5	
FSM15JAE5	FSM8JAE5	
FSM15JAAE5	FSM8JAAE5	
FSM15JLE5	FSM8JARTE6	
FSM16JE5	FSM8JLE5	
FSM16JAE5	FSM8JRTE6	
FSM16JAAE5	FSM8JSMAE10	
FSM16JLE5	FSM8JSMATR ...E10	
FSM17JE5	FSM9JE5	
FSM17JAE5	FSM9JAE5	
FSM17JAAE5	FSM9JAAE5	
FSM17JLE5	FSM9JLE5	
FSM18JE5	FSMCE3	
FSM18JAE5	FSMCDE8	
FSM18JAAE5	FSMCDE8	
FSM18JLE5	FSMCTATRE11	
FSM1JE4,E5	FSMCTTRE11	
FSM1JAE5	FSMJM3.5ATR ...E9	
FSM1JAAE5	FSMJM4.3E9	
FSM1JLE5	FSMJM4.3ATR ...E9	
FSM1LPE15	FSMJM4.3TR ...E9	
FSM1LPAE15	FSMJM5.0ATR ...E9	
FSM1LPATRE15	FSMRA 1JE7	
FSM1LPTRE15	FSMRA 1JLE7	
FSM201AE16	FSMRA 2JE7	
FSM2JE4,E5	FSMRA 2JAE7	
FSM2JAE5	FSMRA 2JHE7	
FSM2JAAE5	FSMRA 2JLE7	
FSM2JARTE6	FSMRA 3JE7	
FSM2JLE5	FSMRA 3JLE7	
FSM2JRTE6	FSMRA 4JE7	
FSM2JSMAE10	FSMRA 4JAE7	
FSM2JSMAA ...E10	FSMRA 4JLE7	
FSM2JSMAATR E10	FSMRA 5JE7	
FSM2JSMATR ...E10	FSMRA 5JLE7	
FSM3JE5	FSMRA 6JE7	
FSM3JAE5	FSMRA 6JLE7	
FSM3JAAE5	FSMRA 7JE7	
FSM3JLE5	FSMRA 7JLE7	
FSM4JE5	FSMRA 8JE7	

E
Tactile Switches

Tactile Switches, .138 [3.5] x .236 [6], Through Hole

MATERIAL SPECIFICATIONS:

ContactsStainless/Silver clad plate
 Case MaterialNylon
 Actuator MaterialPBT
 Terminals/Fixed Contacts.....Copper alloy, Silver/Nickel

TYPICAL PERFORMANCE CHARACTERISTICS:

Contact Rating50 mA @ 12 VDC
 Initial Contact Resistance100 Milliohms max.
 Insulation Resistance100 Megohms min. @ 500 VDC
 Dielectric Strength500 VAC for 1 minute
 Actuation Force130±50 Grams
 Actuator Travel......010"(.254)
 Life ExpectancyUp to 20,000 Cycles



ENVIRONMENTAL SPECIFICATIONS:

Operating Temperature.....-40°F to +185°F (-40°C to + 85°C)
 Storage Temperature.....-40°F to +185°F (-40°C to + 85°C)
 Solder Heat ResistanceSee Page M3-4

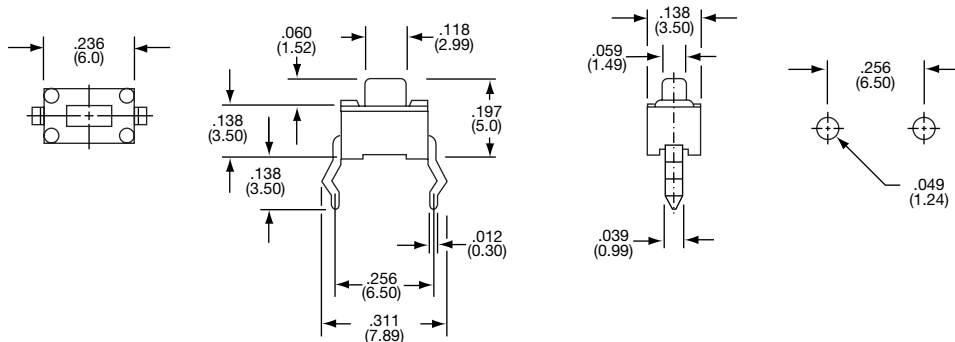
3.5 x 6mm





FSM

Tyco Electronics	Alcoswitch	Type		
1437565-1	FSM	SPST	Off	(On) (On) indicates momentary position.

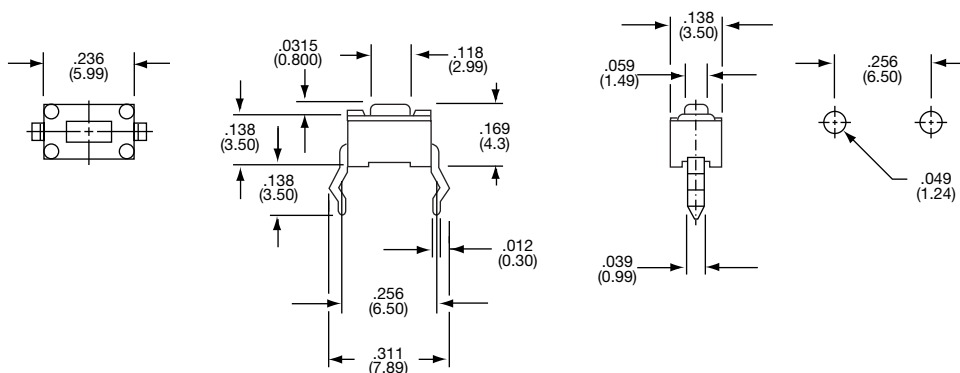
3.5 x 6mm



FSMC

Tyco Electronics	Alcoswitch	Type		
7-1437565-6	FSMC	SPST	Off	(On) (On) indicates momentary position.

Tactile Switches, .236 [6] x .236 [6], Through Hole

MATERIAL SPECIFICATIONS:

ContactsCopper alloy, silver plate
 Case.....Polyamide
 Actuator ButtonPolyacetal Resin
 FrameSteel, tin plate
 TerminalsCopper alloy, silver plate

TYPICAL PERFORMANCE CHARACTERISTICS:

Contact Rating50 mA @ 12 VDC
 Initial Contact Resistance100 Milliohms max.
 Insulation Resistance100 Megohms min. @ 100 VDC
 Dielectric Strength500 VAC
 Actuation ForceSee page E5
 Actuator Travel......012" (0,3)
 Electrostatic Discharge
 w/ESD Ground Terminal5Kv w/no discharge
 Life ExpectancyUp to 100,000 Cycles

ENVIRONMENTAL SPECIFICATIONS

Operating Temperature.....-40°F to +221°F (-40°C to +105°C)
 Storage Temperature.....-40°F to +221°F (-40°C to +105°C)
 Solder Heat ResistanceSee Page M3-4

PART NUMBERING SEQUENCE

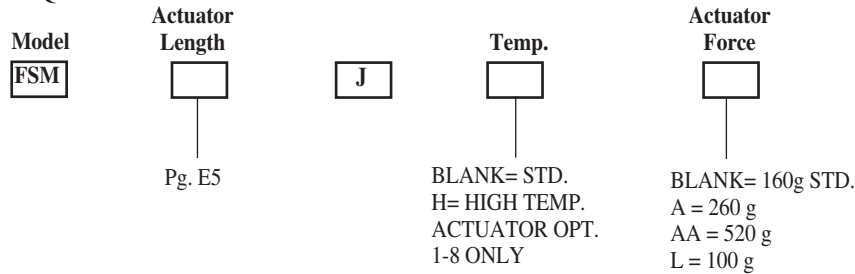

E
FSMJ Series

6 x 6 mm

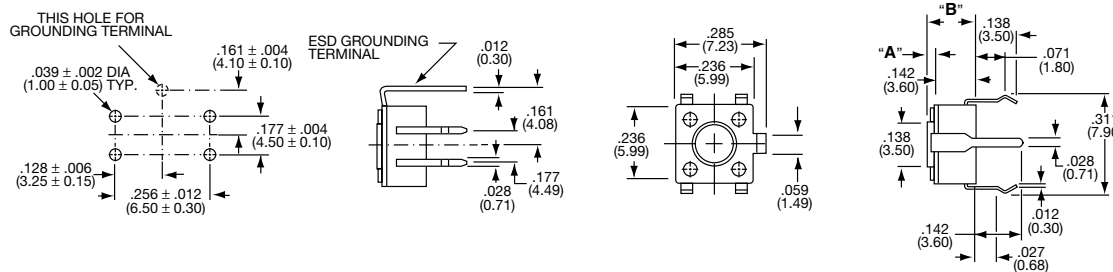

FSM1J WITH ESD TERMINAL

6 x 6 mm

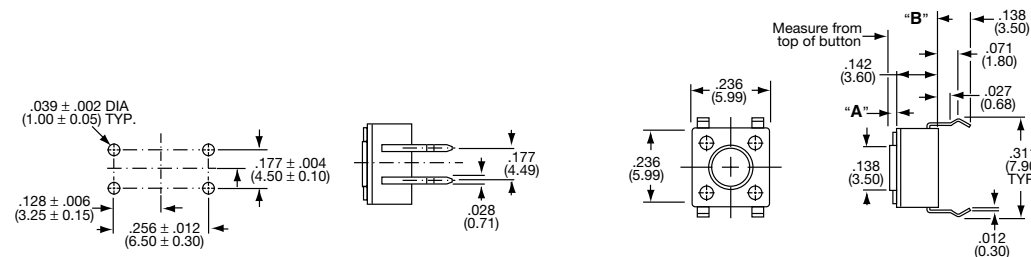

FSM2J WITHOUT ESD TERMINAL

Tactile Switches, .236 [6] x .236 [6], Through Hole (Continued)

TYCO Electronics Part Number	ALCO Part Number	DIMENSIONS		Actuation Force	Actuator Material	Life Cycles
		A	B			
With Ground Terminal						
1-1437565-5	FSM1J	0.028 (0.70)	0.169 (4.30)	160±50gf	PBT	100,000
—	FSM1JAA	0.028 (0.70)	0.169 (4.30)	260±50gf	PBT	100,000
—	FSM1JAA	0.028 (0.70)	0.169 (4.30)	520±100gf	PBT	100,000
—	FSM1JL	0.028 (0.70)	0.169 (4.30)	100±50gf	PBT	100,000
3-1437565-3	FSM3J	0.055 (1.40)	0.196 (5.00)	160±50gf	PBT	100,000
—	FSM3JA	0.055 (1.40)	0.196 (5.00)	260±50gf	PBT	100,000
—	FSM3JAA	0.055 (1.40)	0.196 (5.00)	520±100gf	PBT	100,000
—	FSM3JL	0.055 (1.40)	0.196 (5.00)	100±50gf	PBT	100,000
4-1437565-4	FSM5J	0.134 (3.40)	0.276 (7.00)	160±50gf	ACETAL	100,000
—	FSM5JA	0.134 (3.40)	0.276 (7.00)	260±50gf	ACETAL	100,000
—	FSM5JAA	0.134 (3.40)	0.276 (7.00)	520±100gf	ACETAL	100,000
—	FSM5JL	0.134 (3.40)	0.276 (7.00)	100±50gf	ACETAL	100,000
5-1437565-1	FSM7J	0.232 (5.90)	0.374 (9.50)	160±50gf	PBT	100,000
—	FSM7JA	0.232 (5.90)	0.374 (9.50)	260±50gf	PBT	100,000
—	FSM7JAA	0.232 (5.90)	0.374 (9.50)	520±100gf	PBT	100,000
—	FSM7JL	0.232 (5.90)	0.374 (9.50)	100±50gf	PBT	100,000
7-1437565-5	FSM9J	0.146 (3.70)	0.287 (7.30)	160±50gf	ACETAL	100,000
—	FSM9JA	0.146 (3.70)	0.287 (7.30)	260±50gf	ACETAL	100,000
—	FSM9JAA	0.146 (3.70)	0.287 (7.30)	520±100gf	ACETAL	100,000
—	FSM9JL	0.146 (3.70)	0.287 (7.30)	100±50gf	ACETAL	100,000
1437565-8	FSM11J	0.173 (4.40)	0.315 (8.00)	160±50gf	ACETAL	100,000
—	FSM11JA	0.173 (4.40)	0.315 (8.00)	260±50gf	ACETAL	100,000
—	FSM11JAA	0.173 (4.40)	0.315 (8.00)	520±100gf	ACETAL	100,000
—	FSM11JL	0.173 (4.40)	0.315 (8.00)	100±50gf	ACETAL	100,000
1-1437565-0	FSM13J	0.370 (9.40)	0.512 (13.00)	160±50gf	ACETAL	100,000
1-1437565-1	FSM13JA	0.370 (9.40)	0.512 (13.00)	260±50gf	ACETAL	100,000
—	FSM13JAA	0.370 (9.40)	0.512 (13.00)	520±100gf	ACETAL	100,000
—	FSM13JL	0.370 (9.40)	0.512 (13.00)	100±50gf	ACETAL	100,000
—	FSM15J	0.527 (13.40)	0.669 (17.00)	160±50gf	ACETAL	100,000
147916-1	FSM15JA	0.527 (13.40)	0.669 (17.00)	260±50gf	ACETAL	100,000
—	FSM15JAA	0.527 (13.40)	0.669 (17.00)	520±100gf	ACETAL	100,000
—	FSM15JL	0.527 (13.40)	0.669 (17.00)	100±50gf	ACETAL	100,000
—	FSM17J	0.193 (4.90)	0.335 (8.51)	160±50gf	ACETAL	100,000
—	FSM17JA	0.193 (4.90)	0.335 (8.51)	260±50gf	ACETAL	100,000
—	FSM17JAA	0.193 (4.90)	0.335 (8.51)	520±100gf	ACETAL	100,000
—	FSM17JL	0.193 (4.90)	0.335 (8.51)	100±50gf	ACETAL	100,000
Without Ground Terminal						
2-1437565-0	FSM2J	0.028 (0.70)	0.169 (4.30)	160±50gf	PBT	100,000
2-1437565-1	FSM2JA	0.028 (0.70)	0.169 (4.30)	260±50gf	PBT	100,000
—	FSM2JAA	0.028 (0.70)	0.169 (4.30)	520±100gf	PBT	100,000
—	FSM2JL	0.028 (0.70)	0.169 (4.30)	100±50gf	PBT	100,000
2-1437565-4	FSM4J	0.055 (1.40)	0.196 (5.00)	160±50gf	PBT	100,000
3-1437565-6	FSM4JA	0.055 (1.40)	0.196 (5.00)	260±50gf	PBT	100,000
3-1437565-7	FSM4JAA	0.055 (1.40)	0.196 (5.00)	520±100gf	PBT	100,000
3-1437565-8	FSM4JL	0.055 (1.40)	0.196 (5.00)	100±50gf	PBT	100,000
4-1437565-5	FSM6J	0.134 (3.40)	0.276 (7.00)	160±50gf	ACETAL	100,000
4-1437565-6	FSM6JA	0.134 (3.40)	0.276 (7.00)	260±50gf	ACETAL	100,000
—	FSM6JAA	0.134 (3.40)	0.276 (7.00)	520±100gf	ACETAL	100,000
—	FSM6JL	0.134 (3.40)	0.276 (7.00)	100±50gf	ACETAL	100,000
5-1437565-2	FSM8J	0.232 (5.90)	0.374 (9.50)	160±50gf	PBT	100,000
5-1437565-3	FSM8JA	0.232 (5.90)	0.374 (9.50)	260±50gf	PBT	100,000
5-1437565-4	FSM8JAA	0.232 (5.90)	0.374 (9.50)	520±100gf	PBT	100,000
1571376-1	FSM8JL	0.232 (5.90)	0.374 (9.50)	100±50gf	PBT	100,000
1437565-7	FSM10J	0.146 (3.70)	0.287 (7.30)	160±50gf	ACETAL	100,000
—	FSM10JA	0.146 (3.70)	0.287 (7.30)	260±50gf	ACETAL	100,000
—	FSM10JAA	0.146 (3.70)	0.287 (7.30)	520±100gf	ACETAL	100,000
—	FSM10JL	0.146 (3.70)	0.287 (7.30)	100±50gf	ACETAL	100,000
1437565-9	FSM12J	0.173 (4.40)	0.315 (8.00)	160±50gf	ACETAL	100,000
—	FSM12JA	0.173 (4.40)	0.315 (8.00)	260±50gf	ACETAL	100,000
—	FSM12JAA	0.173 (4.40)	0.315 (8.00)	520±100gf	ACETAL	100,000
—	FSM12JL	0.173 (4.40)	0.315 (8.00)	100±50gf	ACETAL	100,000
1-1437565-2	FSM14J	0.370 (9.40)	0.512 (13.00)	160±50gf	ACETAL	100,000
—	FSM14JA	0.370 (9.40)	0.512 (13.00)	260±50gf	ACETAL	100,000
—	FSM14JAA	0.370 (9.40)	0.512 (13.00)	520±100gf	ACETAL	100,000
—	FSM14JL	0.370 (9.40)	0.512 (13.00)	100±50gf	ACETAL	100,000
1-1437565-3	FSM16J	0.527 (13.40)	0.669 (17.00)	160±50gf	ACETAL	100,000
—	FSM16JA	0.527 (13.40)	0.669 (17.00)	260±50gf	ACETAL	100,000
—	FSM16JAA	0.527 (13.40)	0.669 (17.00)	520±100gf	ACETAL	100,000
—	FSM16JL	0.527 (13.40)	0.669 (17.00)	100±50gf	ACETAL	100,000
1-1437565-4	FSM18J	0.193 (4.90)	0.335 (8.51)	160±50gf	ACETAL	100,000
—	FSM18JA	0.193 (4.90)	0.335 (8.51)	260±50gf	ACETAL	100,000
—	FSM18JAA	0.193 (4.90)	0.335 (8.51)	520±100gf	ACETAL	100,000
—	FSM18JL	0.193 (4.90)	0.335 (8.51)	100±50gf	ACETAL	100,000

Tactile Switches, .236 [6] x .236 [6], Radial Tape

MATERIAL SPECIFICATIONS:

ContactsCopper alloy, silver clad plate
 Case.....Nylon
 Actuator ButtonPBT
 Cover.....Steel, tin plate
 TerminalsCopper alloy, silver clad plate

TYPICAL PERFORMANCE CHARACTERISTICS:

Contact Rating50 mA @ 12 VDC
 Initial Contact Resistance100 Milliohms max.
 Insulation Resistance100 Megohms min. @ 100 VDC
 Dielectric Strength500 VAC for 1 minute
 Actuation ForceSee Below
 Actuator Travel......010" (.254)
 Life ExpectancyUp to 100,000 Cycles

ENVIRONMENTAL SPECIFICATIONS

Operating Temperature..... -40°F to +221°F (-40°C to +105°C)
 Storage Temperature.....-40°F to +221°F (-40°C to +105°C)
 Solder Heat ResistanceSee Page M3-4

E

FSMJRT Series

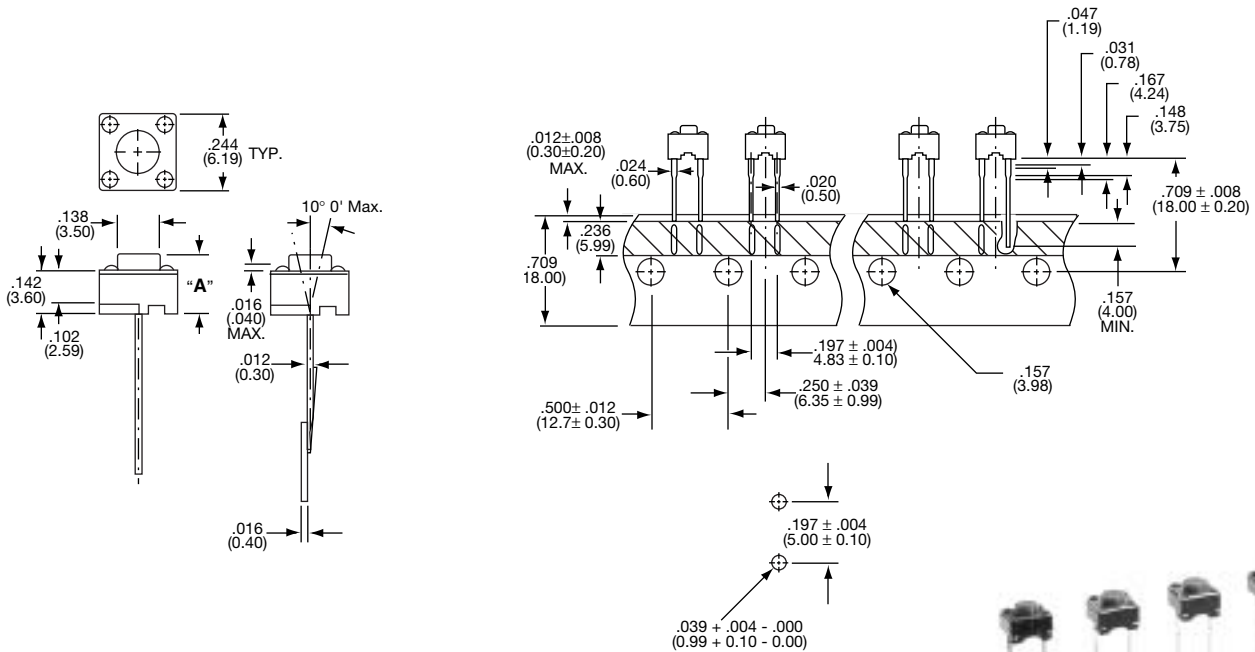

Tyco Electronics	Alcoswitch	Dimension A	Actuation Force
2-1437565-6	FSM2JRT	4.3 (.169)	160 +/-50 gm
2-1437565-2	FSM2JART	4.3 (.169)	260 +/-75 gm
4-1437565-0	FSM4JRT	5.0 (.197)	160 +/-50 gm
147997-1	FSM4JART	5.0 (.197)	260 +/-75 gm
4-1437565-8	FSM6JRT	7.0 (.276)	160 +/-50 gm
1571402-1	FSM6JART	7.0 (.276)	260 +/-75 gm
147694-1	FSM8JRT	9.5 (.374)	160 +/-50 gm
147871-1	FSM8JART	9.5 (.374)	260 +/-75 gm
1571010-1	FSM14JRT	13.0 (.512)	160 +/-50 gm

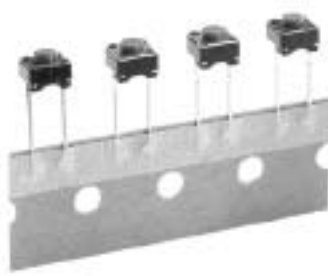

FSM4JRT

Tactile Switches, .236 [6] x .236 [6], Right Angle

MATERIAL SPECIFICATIONS:

ContactsCopper alloy, silver clad plate
 Case.....PBT
 Actuator ButtonNylon/acetal
 FrameSteel, tin plate
 TerminalsCopper alloy, silver plate

TYPICAL PERFORMANCE CHARACTERISTICS:

Contact Rating50 mA @ 12 VDC
 Initial Contact Resistance100 Milliohms max.
 Insulation Resistance100 Megohms min. @ 100 VDC
 Dielectric Strength500 VAC for 1 minute
 Actuation ForceSee Below
 Actuator Travel......012" (0,3)
 Life ExpectancyUp to 100,000 Cycles
 Up to 50,000 Cycles 520 GF (AA option)

ENVIRONMENTAL SPECIFICATIONS

Operating Temperature.....-4°F to +185°F (-20°C to +85°C)
 Storage Temperature.....-22°F to +185°F (-30°C to +85°C)
 Solder Heat ResistanceSee Page M3-4

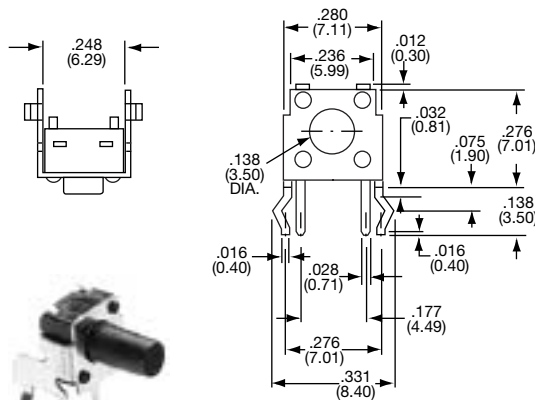

FSMRA7J

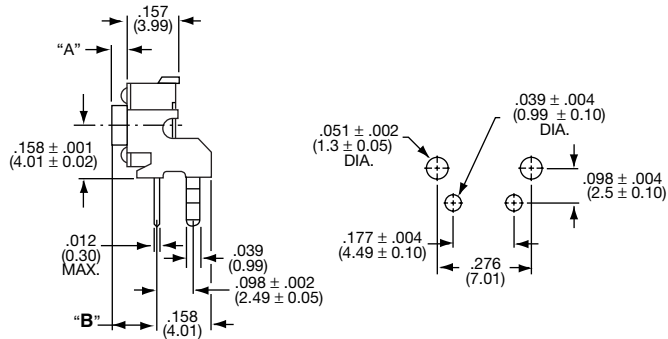

Type		
SPST	Off	(On)
(On) indicates momentary position.		

Tyco Electronics	Alcoswitch	Dim. A	Dim B
8-1437565-4	FSMRA 1J	.022" (0,55)	.124" (3,15)
1571386-2	FSMRA 1JL	.022" (0,55)	.124" (3,15)
8-1437565-5	FSMRA 2J	.049" (1,25)	.152" (3,86)
1571386-1	FSMRA 2JL	.049" (1,25)	.152" (3,86)
8-1437565-8	FSMRA 2JA	.049" (1,25)	.152" (3,86)
8-1437565-9	FSMRA 2JH	.049" (1,25)	.152" (3,86)
9-1437565-0	FSMRA 3J	.128" (3,25)	.230" (5,84)
1571386-3	FSMRA 3JL	.128" (3,25)	.230" (5,84)
9-1437565-1	FSMRA 4J	.226" (5,74)	.329" (8,36)
1571819-1	FSMRA 4JA	.226" (5,74)	.329" (8,36)
1571386-4	FSMRA 4JL	.226" (5,74)	.329" (8,36)
9-1437565-2	FSMRA 5J	.140" (3,55)	.242" (6,15)
1571386-5	FSMRA 5JL	.140" (3,55)	.242" (6,15)
9-1437565-3	FSMRA 6J	.167" (4,25)	.269" (6,85)
1571386-6	FSMRA 6JL	.167" (4,25)	.269" (6,85)
9-1437565-5	FSMRA 7J	.364" (9,25)	.467" (11,86)
1571386-7	FSMRA 7JL	.364" (9,25)	.467" (11,86)
1571419-1	FSMRA 8J	.522" (13,26)	.624" (15,85)
1571386-8	FSMRA 8JL	.522" (13,26)	.624" (15,85)

PART NUMBERING SEQUENCE

Model	Actuator Length	Temperature	Actuation Force
FSMRA		J	
ACTUATOR LENGTH DIM "A"	SWITCH HEIGHT DIM "B"	BLANK = STD. TEMP. H = HIGH TEMP.	BLANK = 160 g (STD.) A = 260 g (OPT.) AA = 520 g (OPT.) L = 100 g (OPT.)
.022" (0,56)	1		
.049" (1,24)	2		
.128" (3,25)	3		
.226" (5,74)	4		
.140" (3,55)	5		
.167" (4,24)	6		
.364" (9,24)	7		
.522" (13,26)	8		

MATERIAL: CASE, PPS
ACTUATOR, PPS
(ACTUATOR OPTIONS 1 - 2)

CONSULT FACTORY FOR OTHER OPTIONS

Tactile Switches, .236 [6] x .236 [6], Square Button, Straight or Right Angle

MATERIAL SPECIFICATIONS:

ContactsCopper alloy, silver clad plate
 Case.....Nylon
 Actuator ButtonPolyacetal Resin
 Cover.....Pet film
 TerminalsCopper alloy, silver plate
 Frame (R/A)Steel, tin plate

TYPICAL PERFORMANCE CHARACTERISTICS:

Contact Rating50 mA @ 12 VDC
 Initial Contact Resistance100 Milliohms Max.
 Insulation Resistance100 Megohms min. @ 100 VDC
 Dielectric Strength500 VAC for 1 minute
 Actuation Force100 and 160 ±50 Grams
 Actuator Travel......010"(.254)
 Life ExpectancyUp to 100,000 Cycles



ENVIRONMENTAL SPECIFICATIONS

Operating Temperature..... -4°F to +185°F (-20°C to +85°C)
 Storage Temperature.....-22°F to +185°F (-30°C to +85°C)
 Solder Heat ResistanceSee Page M3-4

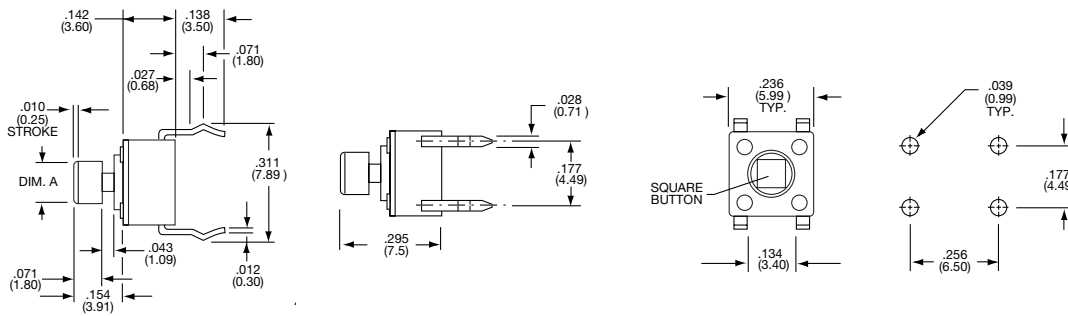
6 x 6 mm



FSMCDA

Tyco Electronics	Alcoswitch	Dim. A	Type			Force
7-1437565-8	FSMCD	.095 (2,42)	SPST	Off	(On)	100±50g
7-1437565-9	FSMCDA	.110 (2,80)	SPST	Off	(On)	160±50g

(On) indicates momentary position.

6 x 6 mm

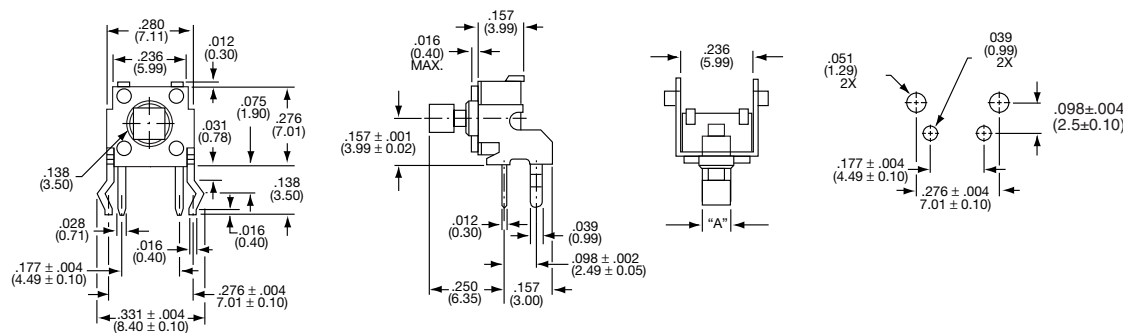

FSMRACDA

Tyco Electronics	Alcoswitch	Dim. A	Force
9-1437565-9	FSMRACD	.095 (2,42)	100±50g
1437566-1	FSMRACDA	.110 (2,80)	160±50g

Tactile Switches, .138 [3.5] x .236 [6], Surface Mount

MATERIAL SPECIFICATIONS:

ContactsStainless steel, silver clad plate
Case MaterialFSMSM: PPS
Actuator MaterialFSMSM: Nylon
FSMJM: PPS
TerminalsCopper alloy, silver plate or tin plate
Cover.....Stainless steel

TYPICAL PERFORMANCE CHARACTERISTICS:

Contact Rating50 mA @ 12 VDC
Initial Contact Resistance100 Milliohms max.
Insulation Resistance100 Megohms min. @ 500 VDC
Dielectric Strength500 VAC for 1 minute
Actuator Travel......010"(.254)
Life Expectancy20,000-40,000 Cycles

ENVIRONMENTAL SPECIFICATIONS:

Operating Temperature.....-40°F to +185°F (-40°C to +85°C)
Storage Temperature.....-40°F to +185°F (-40°C to +85°C)
Solder Heat ResistanceFSMSM IR Soldering EIA-364-56,
Procedure 5 Level 1, 215° C
FSMJM IR Soldering per EIA 364-56
Procedure 5, level 2, 464°F (240°C)

Technical drawing of FSMSM tactile switch with dimensions (e.g., .138, .236, .060), a photograph of the component, and a table of specifications including Tyco Electronics, Alcoswitch, Type (SPST), Packaging (Bulk/Reel), Actuation Force (180±50), and Life Cycle (20,000).

Technical drawing of FSMJM tactile switch with dimensions (e.g., .236, .138, .161 Max., .118), a photograph of the component, and a table of specifications including Tyco Electronics, Alcoswitch, Type (SPST), Dim. A (.197-.169), Actuation Force (180±50-130±50), Packaging (Reel), and Life Cycle (40,000).

Tactile Switches, .236 [6] x .236 [6], Surface Mount

MATERIAL SPECIFICATIONS:

ContactsCopper alloy, silver plate
 Case.....PPS
 Actuator ButtonPPS
 Cover.....Steel, tin plate
 TerminalsCopper alloy, silver plate

TYPICAL PERFORMANCE CHARACTERISTICS:

Contact Rating50 mA @ 12 VDC
 Initial Contact Resistance100 Milliohms max.
 Insulation Resistance100 Megohms min. @ 100 VDC
 Dielectric Strength500 VAC for 1 minute
 Actuation ForceSee Below
 Actuator Travel......010"(.254)
 Life ExpectancyUp to 100,000 Cycles

ENVIRONMENTAL SPECIFICATIONS

Operating Temperature..... -4°F to +185°F (-20°C to +85°C)
 Storage Temperature.....-22°F to +185°F (-30°C to +85°C)
 Solder Heat ResistanceIR Soldering EIA-364-56
 Procedure 5 Level 3, 500°F (260°C)

6 x 6 mm

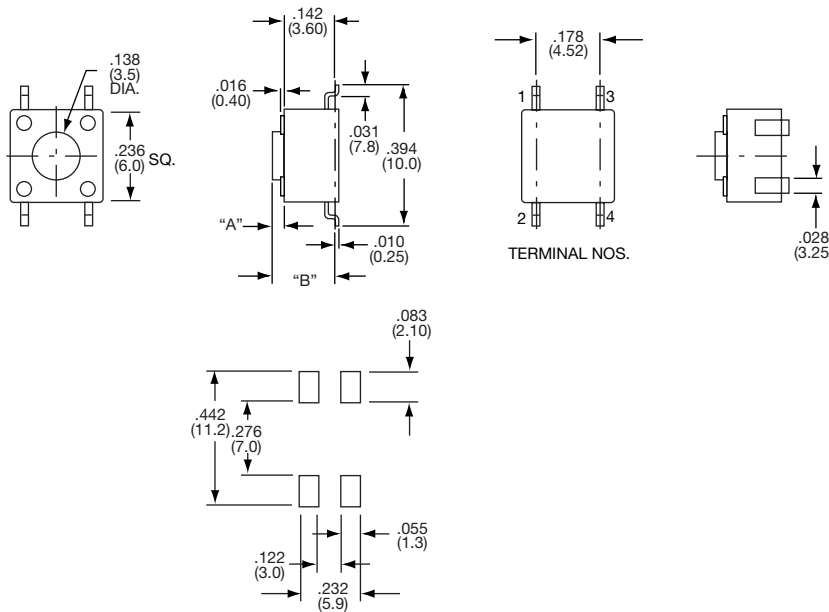

FSMJ SMA

Bulk Pack Part Number		Tape & Reel Part Number		Actuator Length	Switch Height	Actuation Force
Tyco Electronics	Alcoswitch	Tyco Electronics	Alcoswitch	Dimension A	Dimension B	
2-1437565-7	FSM2JSMA	3-1437565-0	FSM2JSMATR	.028 (0.70)	.169 (4.30)	160 ± 50 grams
4-1437565-1	FSM4JSMA	4-1437565-2	FSM4JSMATR	.055 (1.40)	.196 (5.00)	160 ± 50 grams
4-1437565-9	FSM6JSMA	5-1437565-0	FSM6JSMATR	.134 (3.40)	.276 (7.00)	160 ± 50 grams
2-1437565-8	FSM2JSMAA	2-1437565-9	FSM2JSMAATR	.028 (0.70)	.169 (4.30)	260 ± 50 grams
1571563-1	FSM4JSML	1571563-2	FSM4JSMLTR	.055 (1.40)	.196 (5.00)	100 ± 50 grams
1571563-3	FSM4JSMAA	1571563-4	FSM4JSMAATR	.055 (1.40)	.196 (5.00)	260 ± 50 grams
—	FSM6JSMAA	—	FSM6JSMAATR	.134 (3.40)	.276 (7.00)	260 ± 50 grams
3-1437566-8	FSM8JSMA	—	FSM8JSMATR	.232 (5.90)	.374 (9.50)	260 ± 50 grams
1571527-1	FSM2JSML	1571527-2	FSM2JSMLTR	.028 (0.70)	.169 (4.30)	100 ± 50 grams

E
FSMJ SMA Series

Low Profile Series FSMCT Tactile Switches, .196 [5.0] x .196 [5.0], Surface Mount

MATERIAL SPECIFICATIONS:

CoverNickel Silver
Stem/ActuatorBrass-"J" Lead
Brass nickel plate-gullwing

Contacts:

MovingStainless Steel, Silver Clad-Plate
Fixed/TerminalCopper Alloy, Silver-Plate
CaseNylon, UL94V-0

TYPICAL PERFORMANCE CHARACTERISTICS:

Contact Rating20mA @ 15VDC
Initial Contact Resistance100MilliOhms Max
Insulation Resistance100Megaohms @ 100VDC Min.
Dielectric Strength500 VAC for 1 minute
Actuation Travel0.25 +0.1/-0.2
Life ExpectancyUp to 500,000 and 1,000,000 Cycles

ENVIRONMENTAL SPECIFICATIONS:

Operating Temperature-4 to +185°F (-20 to +85°C)
Storage Temperature-22 to +185°F (-30 to +85°C)
Resistance to solder heatPer EIA-364-56A, Procedure 4 & 5,
Level 3
SolderabilityPer EIA-364-52, Class 2, Category 1,
Temp. 473°F (245°C) max., Time 2.5
seconds max., 95% minimum coverage.

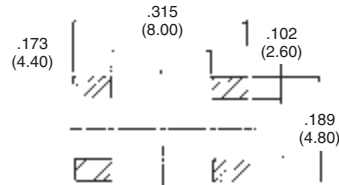
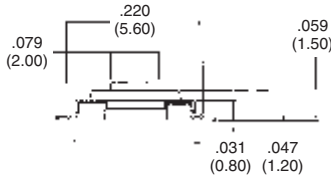
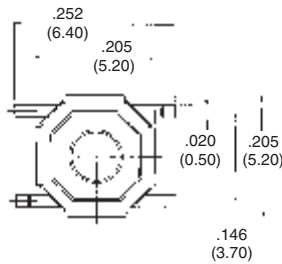

Tyco Electronics	Alcoswitch	Type	Force	Life Cycle
8-1437565-0	FSMCTTR	SPST	160±50	1,000,000
8-1437565-1	FSMCTATR	SPST	260±50	500,000

"J" lead option in development. Contact factory for additional information.

Low Profile, 6 x 6 SMT J-Lead, Extended Life

MATERIAL SPECIFICATIONS:

CoverStainless Steel
 Stem/ActuatorNylon UL94V-0
 Contacts:
 MovingStainless Steel, Silver Clad-Plate
 Fixed/TerminalCopper Alloy, Silver-Plate
 CaseThermoplastic, UL94V-0, Black
 TapeTeflon

TYPICAL PERFORMANCE CHARACTERISTICS:

Contact Rating50mA @ 12 V DC
 Initial Contact Resistance100MilliOhms Max
 Insulation Resistance100Megaohms @ 100VDC Min.
 Dielectric Strength500 VAC for 1 minute
 Actuation Travel.....0.008 +/-0.004 (.2 +/- .10)

ENVIRONMENTAL SPECIFICATIONS:

Operating Temperature-4 to +185°F (-20 to +85°C)
 Storage Temperature-22 to +185°F (-30 to +85°C)
 Resistance to solder heatPer EIA-364-56A, Procedure 4 & 5, Level 3
 SolderabilityPer EIA-364-52, Class 2, Category 1, Temp 473°F (245°C), 95% minimum coverage.

E
Extended Life Series

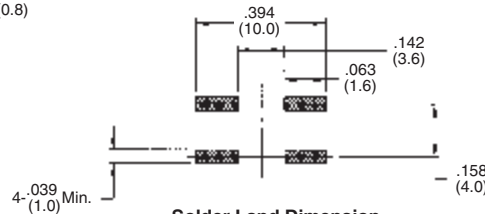
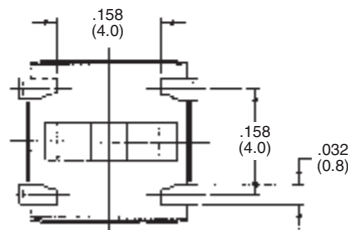
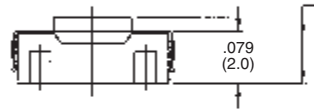
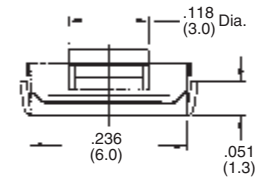
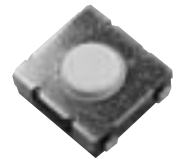
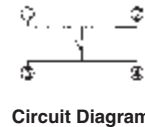
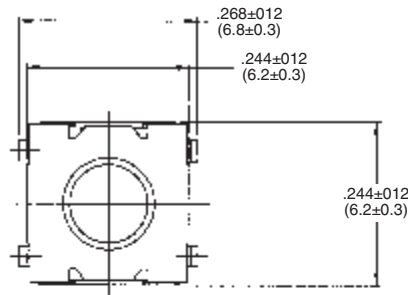

Tyco Electronics	Dim L	Force	Life	Packaging
1571625-1	.098 (2.5)	50gf	2,000,000	Bulk
1571625-2	.098 (2.5)	50gf	2,000,000	T&R
1571625-3	.098 (2.5)	100gf	1,000,000	Bulk
1571625-4	.098 (2.5)	100gf	1,000,000	T&R
1571625-5	.098 (2.5)	160gf	1,000,000	Bulk
1571625-6	.098 (2.5)	160gf	1,000,000	T&R
1571625-7	.098 (2.5)	260gf	100,000	Bulk
1571625-8	.098 (2.5)	260gf	100,000	T&R

Low Profile, 6 x 6 SMT, Gull Wing, Extended Life

MATERIAL SPECIFICATIONS:

CoverCopper Alloy, Tin Lead Plate
 Stem/ActuatorNylon UL94V-0
 Contacts:
 MovingStainless Steel, Silver Clad-Plate
 Fixed/TerminalCopper Alloy, Silver-Plate
 CaseThermoplastic, UL94V-0, Black
 TapeTeflon

TYPICAL PERFORMANCE CHARACTERISTICS:

Contact Rating50mA @ 12 V DC
 Initial Contact Resistance100MilliOhms Max
 Insulation Resistance100Megaohms @ 100VDC Min.
 Dielectric Strength500 VAC for 1 minute
 Actuation Travel0.010 +/-0.004 (.25 +/- .10)

ENVIRONMENTAL SPECIFICATIONS:

Operating Temperature-4 to +185°F (-20 to +85°C)
 Storage Temperature-22 to +185°F (-30 to +85°C)
 Resistance to solder heatPer EIA-364-56A, Procedure 4 & 5, Level 3
 SolderabilityPer EIA-364-52, Class 2, Category 1, Temp 473°F (245°C) max., time 2.5 seconds max., 95% minimum coverage.

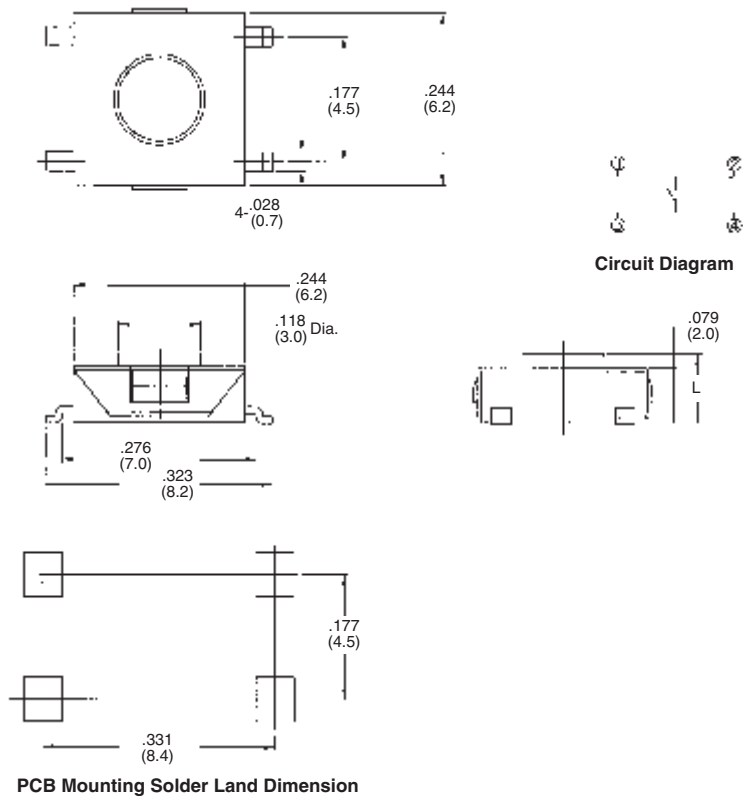

Tyco Electronics	Dim L	Force	Life	Packaging
1571626-1	.098 (2.5)	50gf	1,000,000	Bulk
1571626-2	.098 (2.5)	50gf	1,000,000	T&R
1571626-3	.098 (2.5)	100gf	1,000,000	Bulk
1571626-4	.098 (2.5)	100gf	1,000,000	T&R
1571626-5	.098 (2.5)	160gf	1,000,000	Bulk
1571626-6	.098 (2.5)	160gf	1,000,000	T&R
1571626-7	.079 (2.0)	160gf	1,000,000	Bulk
1571626-8	.079 (2.0)	160gf	1,000,000	T&R
1571626-9	.098 (2.5)	260gf	100,000	Bulk
1-1571626-0	.098 (2.5)	260gf	100,000	T&R

Low Profile, 6 x 6 SMT, Gull Wing w/ESD Terminal, Extended Life

MATERIAL SPECIFICATIONS:

CoverCopper Alloy, Tin Lead Plate
 Stem/ActuatorNylon UL94V-0
 Contacts:
 MovingStainless Steel, Silver Clad-Plate
 Fixed/TerminalCopper Alloy, Silver-Plate
 CaseThermoplastic, UL94V-0, Black
 TapeTeflon

TYPICAL PERFORMANCE CHARACTERISTICS:

Contact Rating50mA @ 12 V DC
 Initial Contact Resistance100Milliohms Max
 Insulation Resistance100Megaohms @ 100V DC Min.
 Dielectric Strength500 VAC for 1 minute
 Actuation Travel.....0.010 +/- .004 (.25 +/- .10)

ENVIRONMENTAL SPECIFICATIONS:

Operating Temperature-4 to +185°F (-20 to +85°C)
 Storage Temperature-22 to +185°F (-30 to +85°C)
 Resistance to solder heatPer EIA-364-56A, Procedure 4 & 5, Level 3
 SolderabilityPer EIA-364-52, Class 2, Category 1, Temp 473°F (245°C) max., time 2.5 seconds max., 95% minimum coverage.

E
Extended Life Series

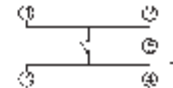
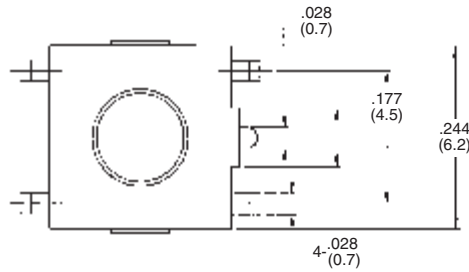

Circuit Diagram

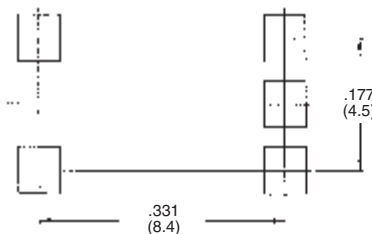
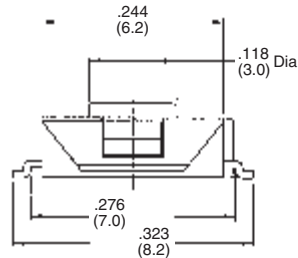

PCB Mounting Solder Land Dimension

Tyco Electronics	Dim L	Force	Life	Packaging
1571636-1	.098 (2.5)	50gf	1,000,000	Bulk
1571636-2	.098 (2.5)	50gf	1,000,000	T&R
1571636-3	.098 (2.5)	100gf	1,000,000	Bulk
1571636-4	.098 (2.5)	100gf	1,000,000	T&R
1571636-5	.098 (2.5)	160gf	1,000,000	Bulk
1571636-6	.098 (2.5)	160gf	1,000,000	T&R
1571636-7	.079 (2.0)	160gf	1,000,000	Bulk
1571636-8	.079 (2.0)	160gf	1,000,000	T&R
1571636-9	.098 (2.5)	260gf	100,000	Bulk
1-1571636-0	.098 (2.5)	260gf	100,000	T&R

Tactile Switches, .236 [6] x .236 [6], Low Profile, Surface Mount

MATERIAL SPECIFICATIONS:

ContactsCopper Alloy, silver clad plated
 Case MaterialPPS
 StemPPS
 Cover.....Steel, tin-plate
 TerminalsCopper alloy, silver plated

TYPICAL PERFORMANCE CHARACTERISTICS:

Contact Rating50mA @ 12 VDC
 Initial Contact Resistance100 Milliohms max.
 Insulation Resistance100 Megohms min. @ 100 VDC
 Dielectric Strength500 VAC, 1 minute
 Actuation ForceSee Below.
 Life ExpectancyUp to 100,000 Cycles

ENVIRONMENTAL SPECIFICATIONS:

Operating Temperature.....-4°F to +185°F (-20°C to +85°C)
 Storage Temperature.....-22°F to +185°F (-30°C to +85°C)
 Solder Heat ResistanceIR Soldering EIA-364-56
 Procedure 5 Level 2, 464°F (240°C)



FSM1LP

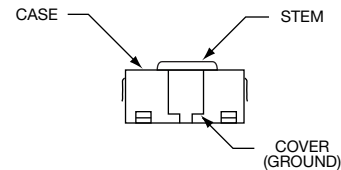
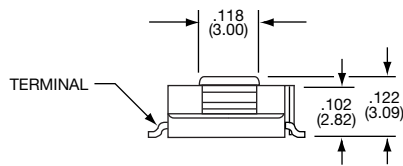
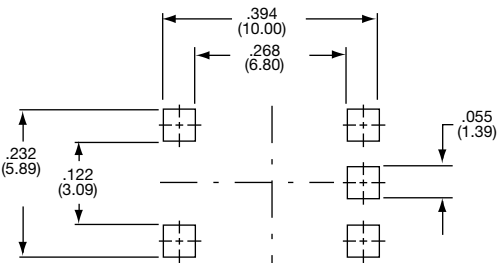
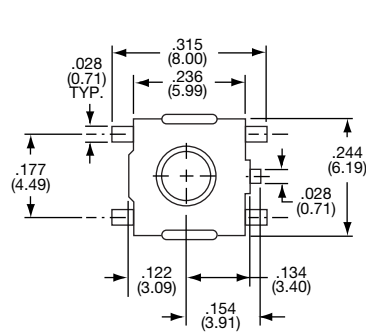

FSM4LP

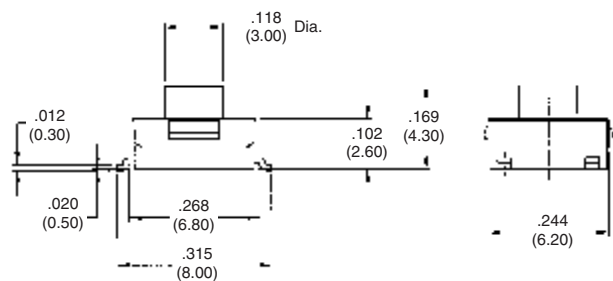
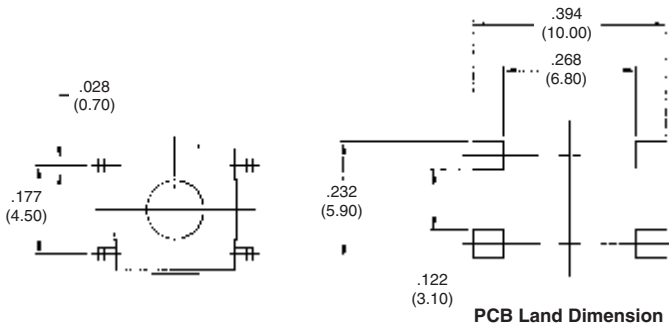

Tyco Electronics	Alcoswitch	Force	Actuator Packaging
1-1437565-6	FSM1LP	160	Bulk
1-1437565-7	FSM1LPA	260	Bulk
1-1437565-9	FSM1LPTR	160	Tape & Reel
1-1437565-8	FSM1LPATR	260	Tape & Reel
1571621-1	FSM4LP	260	Bulk
4-1437565-3	FSM4LPTR	260	Tape & Reel

E
FSM1LP Series

Tactile Switches, .472 [12] x .472 [12], Flush or Extended Actuators

MATERIAL SPECIFICATIONS:

ContactsCopper alloy, silver clad plate
 Case.....PBT
 Actuator ButtonPolyacetal Resin
 Cover.....PET film
 TerminalsCopper alloy, silver plate
 Frame (R/A)Nylon

TYPICAL PERFORMANCE CHARACTERISTICS:

Contact Rating50 mA @ 12 VDC
 Initial Contact Resistance100 Milliohms max.
 Insulation Resistance100 Megohms min. @100 VDC
 Dielectric Strength500 VAC for 1 minute
 Actuation ForceSee below
 Actuator Travel.....0.012"(0.3)
 Life ExpectancyUp to 100,000 cycles

ENVIRONMENTAL SPECIFICATIONS

Operating Temperature.....4°F to +185°F (-20°C to +85°C)
 Storage Temperature.....-22°F to +185°F (-30°C to +85°C)
 Solder Heat ResistanceSee Page M3-4



FSM100

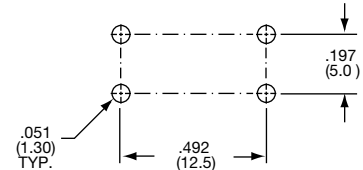
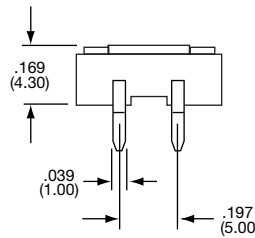
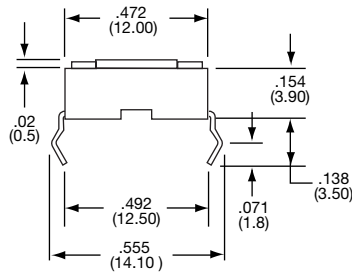
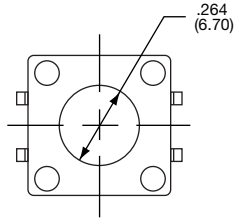

Tyco Electronics	Alcoswitch	Type			Force
1437565-2	FSM100	SPST	Off	(On)	160±50gf
1571139-1	FSM100A	SPST	Off	(On)	260±50gf

(On) indicates momentary position.



FSM101

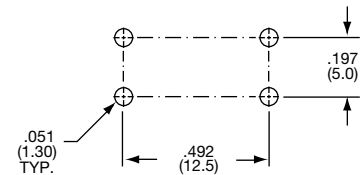
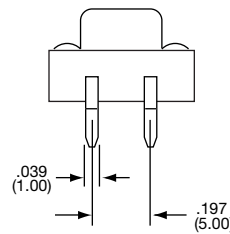
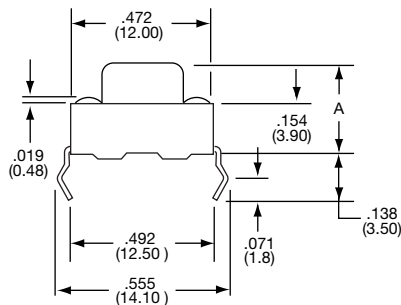
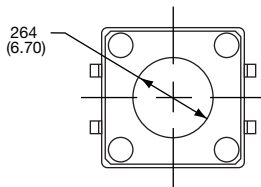

Tyco Electronics	Alcoswitch	Type			Force	Dim A
1437565-3	FSM101	SPST	Off	(On)	160±50gf	.295 [7.5mm]
1571140-1	FSM201A	SPST	Off	(On)	260±50gf	.335 [8.5mm]

(On) indicates momentary position.

E
FSM100-104 Series

Tactile Switches, .472 [12] x .472 [12], Vertical or Right Angle

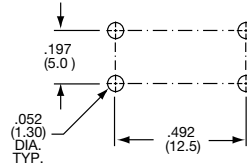
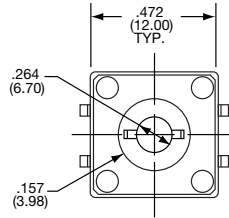
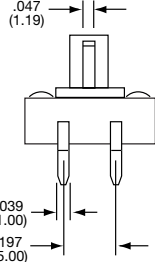
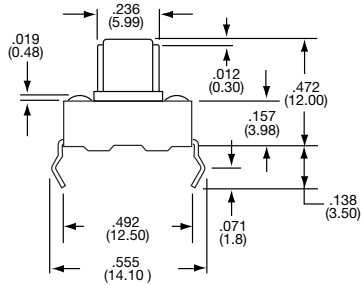

FSM102

Tyco Electronics	Alcoswitch	Type			Force
1437565-4	FSM102	SPST	Off	(On)	160±50gf
1571061-1	FSM102A	SPST	Off	(On)	260±50gf

(On) indicates momentary position.

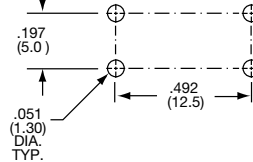
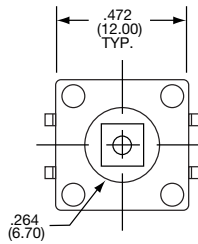
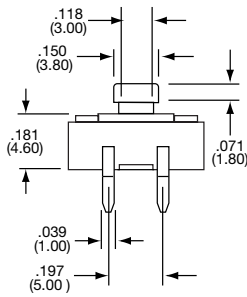
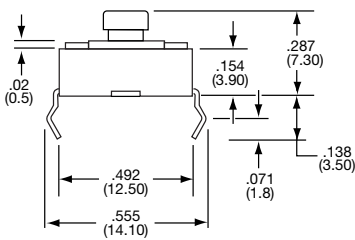

FSM103

Tyco Electronics	Alcoswitch	Type			Force
1437565-5	FSM103	SPST	Off	(On)	160±50gf

(On) indicates momentary position.

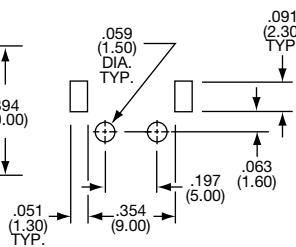
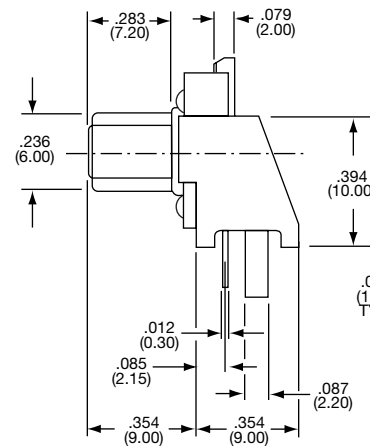
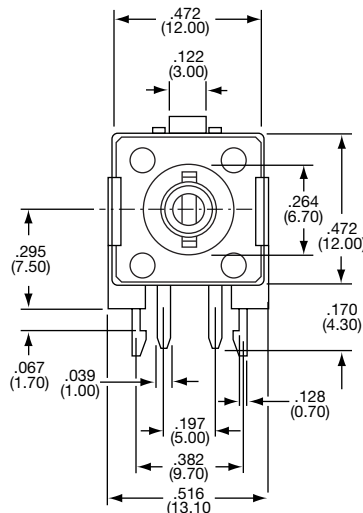

Tyco Electronics	Alcoswitch	Type			Force
1437565-6	FSM104	SPST	Off	(On)	160±50gf

(On) indicates momentary position.



Tactile Switches, Sealed .472 [12] x .472 [12], Surface Mount, Projected Actuator

MATERIAL SPECIFICATIONS:

CaseThermoplastic, UL94V-0, Black
 Stem/ActuatorThermoplastic, UL94V-0, Black
 CoverStainless Steel
 SealSilicone Rubber, Black
 Contact.....Stainless Steel, Plating—Silver
 TerminalCopper Alloy, Plating—Silver/Nickel

TYPICAL PERFORMANCE CHARACTERISTICS:

Contact Rating50mA @ 12 V DC
 Initial Contact Resistance100MilliOhms Max
 Insulation Resistance100Megaohms @ 100VDC Min.
 Dielectric Strength500 VAC
 Actuation Travel.....0.014 +/- .008 (.35 +/- .20)
 LifeUp to 1,000,000 Cycles

ENVIRONMENTAL SPECIFICATIONS:

Operating Temperature-4 to +185°F (-20 to +70°C)
 Storage Temperature-4 to +185°F (-20 to +70°C)
 Resistance to solder heatPer EIA-364-56, Procedure 4 & 5, Level 3
 SolderabilityPer EIA RS-186-9E
 SealPer IP67

E

Sealed Tactile Switches

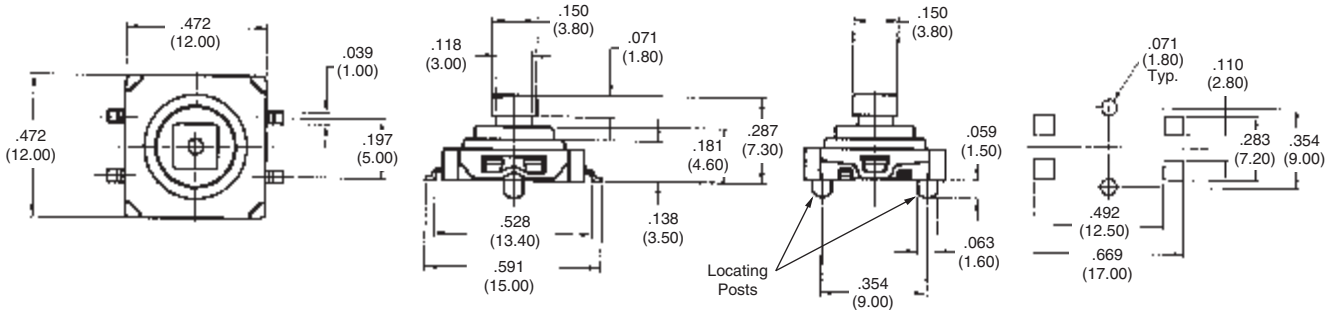

Tyco Electronics	Locating Post	Packaging	Actuator Height	Force
1571217-1	No	Bulk	.287 (7.30)	160±70gf
1571217-2	Yes	Bulk	.287 (7.30)	160±70gf
1571217-3	No	T&R	.287 (7.30)	160±70gf
1571217-4	Yes	T&R	.287 (7.30)	160±70gf

Tactile Switches, Sealed .472 [12] x .472 [12], Surface Mount, Flush, Actuator

MATERIAL SPECIFICATIONS:

CaseThermoplastic, UL94V-0, Black
 Stem/ActuatorThermoplastic, UL94V-0, Black
 CoverStainless Steel
 SealSilicone Rubber, Black
 Contact.....Stainless Steel, Plating—Silver
 TerminalCopper Alloy, Plating—Silver/Nickel

TYPICAL PERFORMANCE CHARACTERISTICS:

Contact Rating50mA @ 12 V DC
 Initial Contact Resistance100MilliOhms Max
 Insulation Resistance100Megaohms @ 100VDC Min.
 Dielectric Strength500 VAC
 Actuation Travel.....0.014 +/-0.008 (.35 +/- .20)
 LifeUp to 1,000,000 Cycles

ENVIRONMENTAL SPECIFICATIONS:

Operating Temperature-4 to +185°F (-20 to +85°C)
 Storage Temperature-4 to +185°F (-20 to +85°C)
 Resistance to solder heatPer EIA-364-56, Procedure 4 & 5, Level 3
 SolderabilityPer EIA RS-186-9E
 SealPer IP67

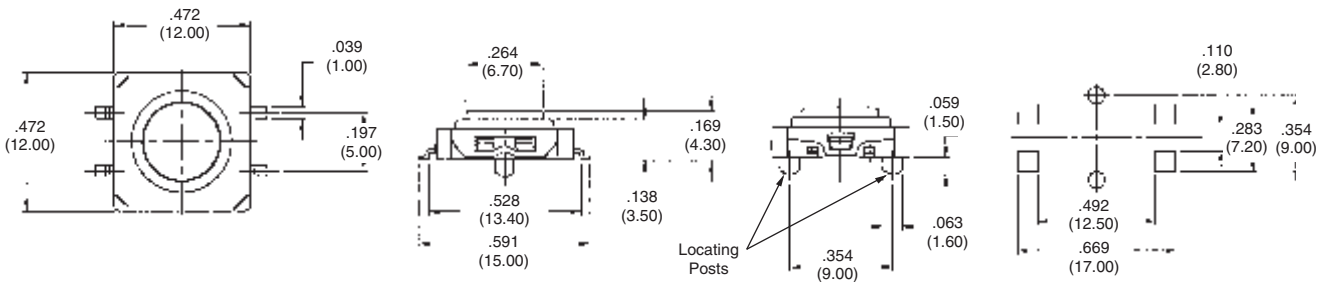

Tyco Electronics	Locating Post	Packaging	Actuator Height	Force
1571218-1	No	Bulk	.169 (4.30)	160±70gf
1571218-2	Yes	Bulk	.169 (4.30)	160±70gf
1571218-3	No	T&R	.169 (4.30)	160±70gf
1571218-4	Yes	T&R	.169 (4.30)	160±70gf

E
Sealed Tactile Switches

Tactile Switches, Sealed .472 [12] x .472 [12], Thru-Hole, Projected Actuator

MATERIAL SPECIFICATIONS:

CaseThermoplastic, UL94V-0, Black
 Stem/ActuatorThermoplastic, UL94V-0, Black
 CoverStainless Steel
 SealSilicone Rubber, Black
 Contact.....Stainless Steel, Plating—Silver
 TerminalCopper Alloy, Plating—Silver/Nickel

TYPICAL PERFORMANCE CHARACTERISTICS:

Contact Rating50mA @ 12 V DC
 Initial Contact Resistance100MilliOhms Max
 Insulation Resistance100Megaohms @ 100VDC Min.
 Dielectric Strength500 VAC
 Actuation Travel.....0.014 +/- .008 (.35 +/- .20)
 Life1,000,000 Cycles

ENVIRONMENTAL SPECIFICATIONS:

Operating Temperature-4 to +185°F (-20 to +85°C)
 Storage Temperature-4 to +185°F (-20 to +85°C)
 Resistance to solder heatPer EIA-364-56, Procedure 3, Test Cond. B
 SolderabilityPer EIA RS-186-9E
 SealPer IP67

E

Sealed Tactile Switches

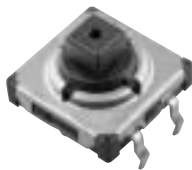
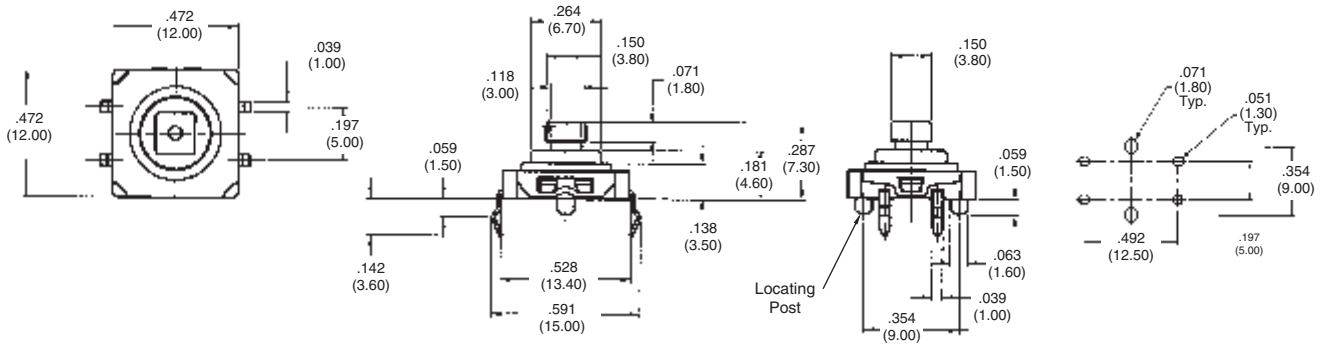

Tyco Electronics	Locating Post	Packaging	Actuator Height	Force
1571219-1	No	Bulk	.287 (7.30)	160±70gf
1571219-2	Yes	Bulk	.287 (7.30)	160±70gf

Tactile Switches, Sealed .472 [12] x .472 [12], Thru-Hole, Flush Actuator

MATERIAL SPECIFICATIONS:

CaseThermoplastic, UL94V-0, Black
 Stem/ActuatorThermoplastic, UL94V-0, Black
 CoverStainless Steel
 SealSilicone Rubber, Black
 Contact.....Stainless Steel, Plating—Silver
 TerminalCopper Alloy, Plating—Silver/Nickel

TYPICAL PERFORMANCE CHARACTERISTICS:

Contact Rating50mA @ 12 V DC
 Initial Contact Resistance100MilliOhms Max
 Insulation Resistance100Megaohms @ 100VDC Min.
 Dielectric Strength500 VAC
 Actuation Travel.....0.014 +/-0.008 (.35 +/- .20)
 Life1,000,000 Cycles

ENVIRONMENTAL SPECIFICATIONS:

Operating Temperature-4 to +185°F (-20 to +85°C)
 Storage Temperature-4 to +185°F (-20 to +85°C)
 Resistance to solder heatPer EIA-364-56, Procedure 3, Test Cond. B
 SolderabilityPer EIA RS-186-9E
 SealPer IP67

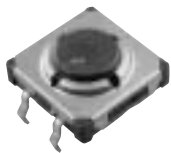
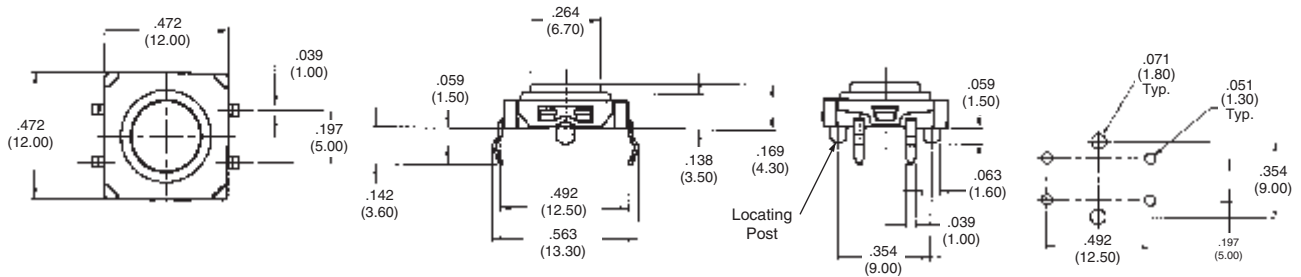

Tyco Electronics	Locating Post	Packaging	Actuator Height	Force
1571220-1	No	Bulk	.169 (4.30)	160±70gf
1571220-2	Yes	Bulk	.169 (4.30)	160±70gf

E
Sealed Tactile Switches

Tactile Switches, Sealed .299 [7.6] x .287 [7.3], Surface Mount, Extended Actuator

MATERIAL SPECIFICATIONS:

CaseThermoplastic, UL94V-0, Black
 Stem/ActuatorThermoplastic, UL94V-0, Black
 CoverStainless Steel
 SealSilicone Rubber, Black
 Contact.....Stainless Steel, Plating—Silver
 TerminalCopper Alloy, Plating—Silver

TYPICAL PERFORMANCE CHARACTERISTICS:

Contact Rating50mA @ 12 V DC
 Initial Contact Resistance100MilliOhms Max
 Insulation Resistance100Megaohms @ 100VDC Min.
 Dielectric Strength500 VAC
 Actuation Travel.....0.014 +/- .008 (.35 +/- .20)
 LifeUp to 1,000,000 Cycles

ENVIRONMENTAL SPECIFICATIONS:

Operating Temperature-4 to +185°F (-20 to +85°C)
 Storage Temperature-4 to +185°F (-20 to +85°C)
 Resistance to solder heatPer EIA-364-56, Procedure 4 & 5, Level 3
 SolderabilityPer EIA RS-186-9E
 SealPer IP67

E

Sealed Tactile Switches

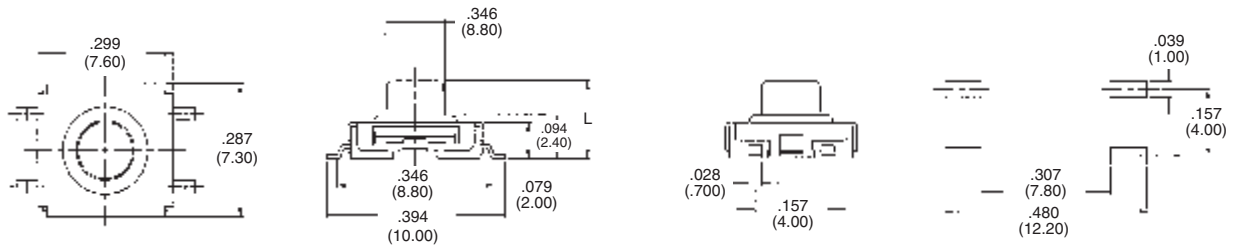

Tyco Electronics	Packaging	L	Force
1571294-1	Bulk	.169 (4.30)	160±50gf
1571294-2	T&R	.169 (4.30)	160±50gf
1571294-3	Bulk	.197 (5.00)	160±50gf
1571294-4	T&R	.197 (5.00)	160±50gf

Tactile Switches, Sealed .299 [7.6] x .287 [7.3], Surface Mount, Flush Actuator

MATERIAL SPECIFICATIONS:

CaseThermoplastic, UL94V-0, Black
 Stem/ActuatorThermoplastic, UL94V-0, Black
 CoverStainless Steel
 SealSilicone Rubber, Black
 Contact.....Stainless Steel, Plating—Silver
 TerminalCopper Alloy, Plating—Silver/Nickel

TYPICAL PERFORMANCE CHARACTERISTICS:

Contact Rating50mA @ 12 V DC
 Initial Contact Resistance100MilliOhms Max
 Insulation Resistance100Megaohms @ 100VDC Min.
 Dielectric Strength500 VAC
 Actuation Travel.....0.014 +/- .008 (.35 +/- .20)
 LifeUp to 1,000,000 Cycles

ENVIRONMENTAL SPECIFICATIONS:

Operating Temperature-4 to +185°F (-20 to +85°C)
 Storage Temperature-4 to +185°F (-20 to +85°C)
 Resistance to solder heatPer EIA-364-56, Procedure 4 & 5, Level 3
 SolderabilityPer EIA RS-186-9E
 SealPer IP67

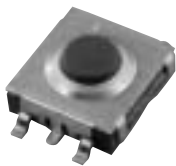
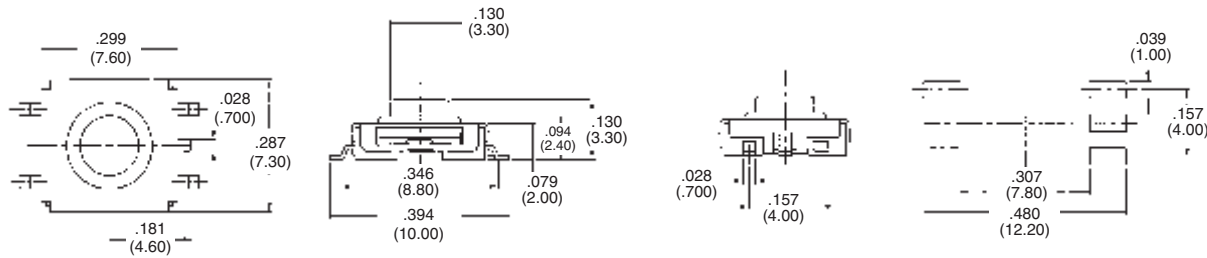

Tyco Electronics	Packaging	Actuator Height	Force
1571296-1	Bulk	.130 (3.30)	160±50gf
1571296-2	T&R	.130 (3.30)	160±50gf

E
Sealed Tactile Switches

Tactile Switches, Sealed .299 [7.6] x .287 [7.3], Thru-Hole, Extended Actuator

MATERIAL SPECIFICATIONS:

CaseThermoplastic, UL94V-0, Black
 ActuatorThermoplastic, UL94V-0, Black
 CoverStainless Steel
 SealSilicone Rubber, Black
 Contact.....Stainless Steel, Plating—Silver
 TerminalCopper Alloy, Plating—Silver/Nickel

TYPICAL PERFORMANCE CHARACTERISTICS:

Contact Rating50mA @ 12 V DC
 Initial Contact Resistance100MilliOhms Max
 Insulation Resistance100Megaohms @ 100VDC Min.
 Dielectric Strength500 VAC
 Actuation Travel0.014 +/-0.008 (.35 +/- .20)
 LifeUp to 1,000,000 Cycles

ENVIRONMENTAL SPECIFICATIONS:

Operating Temperature-4 to +185°F (-20 to +85°C)
 Storage Temperature-4 to +185°F (-20 to +85°C)
 Resistance to solder heatPer EIA-364-56, Procedure 3, Test Cond.B
 SolderabilityPer EIA RS-186-9E
 SealPer IP67

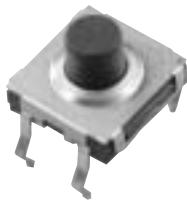
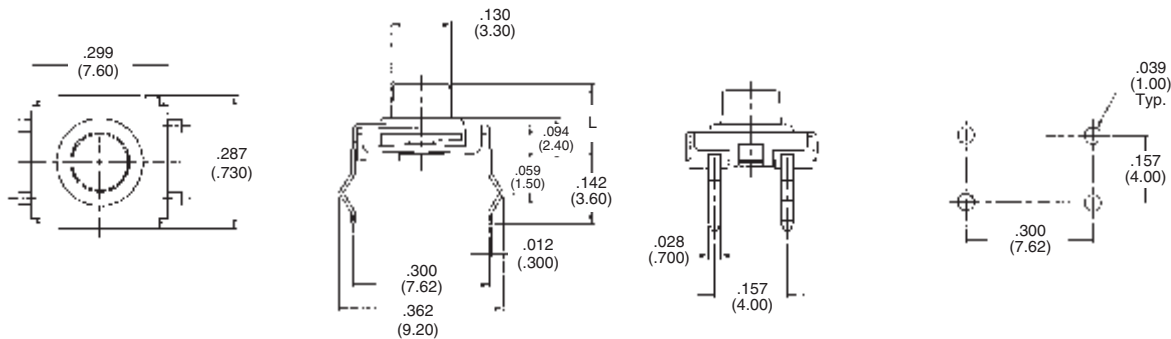

Tyco Electronics	Packaging	L	Force
1571295-1	Bulk	.169 (4.30)	160±50gf
1571295-2	Bulk	.197 (5.00)	160±50gf

E

Sealed Tactile Switches

Tactile Switches, Sealed .185 [4.7] x .268 [6.8], Surface Mount

MATERIAL SPECIFICATIONS:

CaseThermoplastic, UL94V-0, Black
 Stem/ActuatorThermoplastic, UL94V-0, Black
 CoverStainless Steel
 SealSilicone Rubber, Black
 Contact.....Stainless Steel, Plating—Silver
 TerminalCopper Alloy, Plating—Silver/Nickel

TYPICAL PERFORMANCE CHARACTERISTICS:

Contact Rating50mA @ 12 V DC
 Initial Contact Resistance100MilliOhms Max
 Insulation Resistance100Megaohms @ 100VDC Min.
 Dielectric Strength500 VAC
 Actuation Travel.....0.014 +/-0.008 (.35 +/- .20)
 LifeUp to 50,000 Cycles

ENVIRONMENTAL SPECIFICATIONS:

Operating Temperature-4 to +185°F (-20 to +85°C)
 Storage Temperature-4 to +185°F (-20 to +85°C)
 Resistance to solder heatPer EIA-364-56, Procedure 4 & 5, Level 3
 SolderabilityPer EIA RS-186-9E
 SealPer IP67

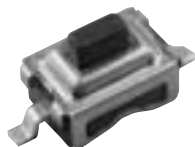
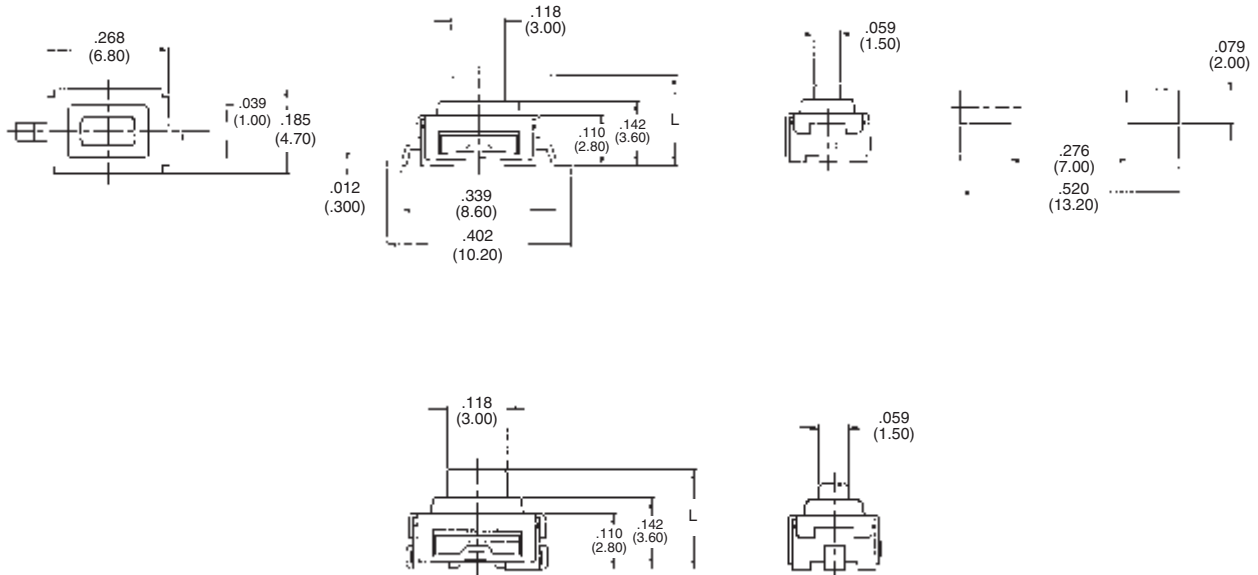

Tyco Electronics	Packaging	L	Operating Force	Lead Style
1571298-1	Bulk	.197 (5.00)	130 ± 50gf	Gull Wing
1571298-2	T&R	.197 (5.00)	130 ± 50gf	Gull Wing
1571299-1	Bulk	.169 (4.30)	130 ± 50gf	J Lead
1571299-2	T&R	.169 (4.30)	130 ± 50gf	J Lead
1571299-3	Bulk	.197 (5.00)	130 ± 50gf	J Lead
1571299-4	T&R	.197 (5.00)	130 ± 50gf	J Lead

E
Sealed Tactile Switches

Tactile Switches, Sealed .185 [4.7] x .268 [6.8], Thru-Hole

MATERIAL SPECIFICATIONS:

CaseThermoplastic, UL94V-0, Black
 Stem/ActuatorThermoplastic, UL94V-0, Black
 CoverStainless Steel
 SealSilicone Rubber, Black
 Contact.....Stainless Steel, Plating—Silver
 TerminalCopper Alloy, Plating—Silver/Nickel

TYPICAL PERFORMANCE CHARACTERISTICS:

Contact Rating50mA @ 12 V DC
 Initial Contact Resistance100MilliOhms Max
 Insulation Resistance100Megaohms @ 100VDC Min.
 Dielectric Strength500 VAC
 Actuation Travel.....0.014 +/- .008 (.35 +/- .20)
 LifeUp to 50,000 Cycles

ENVIRONMENTAL SPECIFICATIONS:

Operating Temperature-4 to +185°F (-20 to +85°C)
 Storage Temperature-4 to +185°F (-20 to +85°C)
 Resistance to solder heatPer EIA-364-56, Procedure 3, Test Cond. B
 SolderabilityPer EIA RS-186-9E
 SealPer IP67

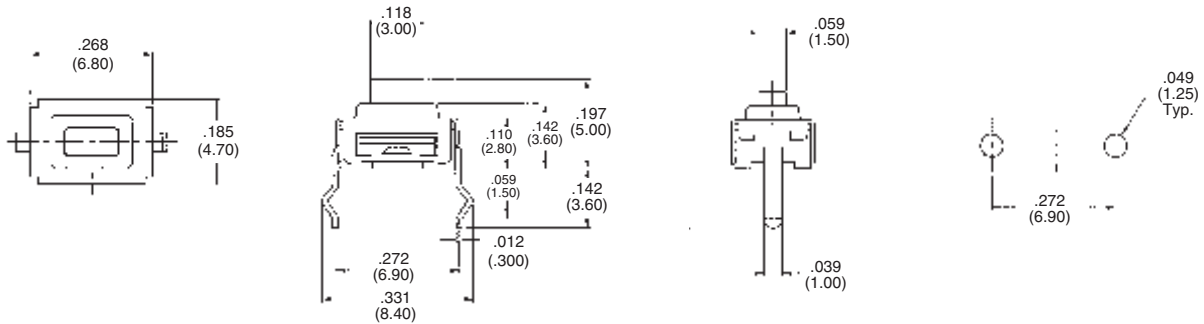

Tyco Electronics	Packaging	Actuator Height	Operating Force
1571297-1	Bulk	.197 (5.00)	130 ± 50gf

E

Sealed Tactile Switches

Tactile Switches, Sealed Right Angle, Surface Mount

MATERIAL SPECIFICATIONS:

CaseThermoplastic, UL94V-0, Black
 Stem/ActuatorThermoplastic, UL94V-0, Black
 CoverStainless Steel
 SealSilicone Rubber, Black
 Contact.....Stainless Steel, Plating—Silver
 TerminalCopper Alloy, Plating—Silver/Nickel

TYPICAL PERFORMANCE CHARACTERISTICS:

Contact Rating50mA @ 12 V DC
 Initial Contact Resistance100MilliOhms Max
 Insulation Resistance100Megaohms @ 100VDC Min.
 Dielectric Strength500 VAC
 Actuation Travel.....0.014 +/- .008 (.35 +/- .20)
 LifeUp to 1,000,000 Cycles

ENVIRONMENTAL SPECIFICATIONS:

Operating Temperature-4° to +185°F (-20°to +85°C)
 Storage Temperature-4° to +185°F (-20°to +85°C)
 Resistance to solder heatPer EIA-364-56, Procedure 4 & 5, Level 3
 SolderabilityPer EIA RS-186-9E
 SealPer IP67

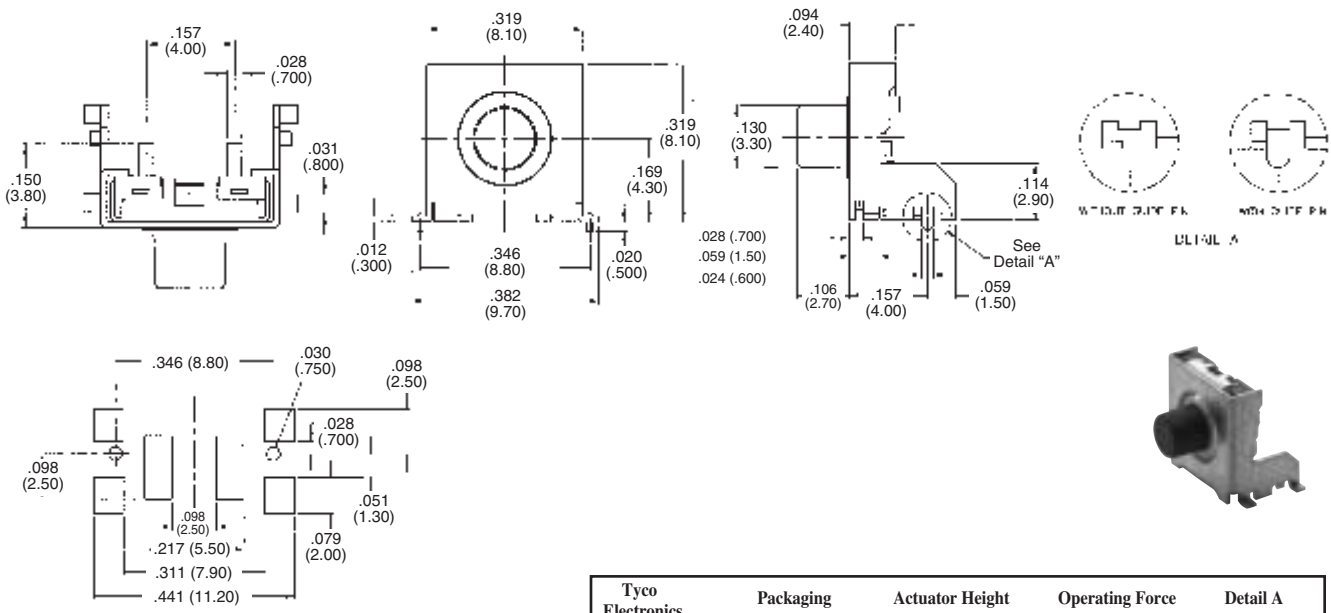

Tyco Electronics	Packaging	Actuator Height	Operating Force	Detail A
1571300-1	Bulk	.106 (2.70)	130 ± 50gf	Without Pin
1571300-2	Bulk	.106 (2.70)	130 ± 50gf	With Pin

E
Sealed Tactile Switches

Tactile Switches, Sealed Right Angle, Surface Mount

MATERIAL SPECIFICATIONS:

CaseThermoplastic, UL94V-0, Black
 Stem/ActuatorThermoplastic, UL94V-0, Black
 CoverStainless Steel
 SealSilicone Rubber, Black
 Contact.....Stainless Steel, Plating—Silver
 TerminalCopper Alloy, Plating—Silver

TYPICAL PERFORMANCE CHARACTERISTICS:

Contact Rating50mA @ 12 V DC
 Initial Contact Resistance100MilliOhms Max
 Insulation Resistance100Megaohms @ 100VDC Min.
 Dielectric Strength500 VAC
 Actuation Travel.....0.014 +/- .008 (.35 +/- .20)
 LifeUp to 1,000,000 Cycles

ENVIRONMENTAL SPECIFICATIONS:

Operating Temperature-4° to +185°F (-20°to +85°C)
 Storage Temperature-4° to +185°F (-20°to +85°C)
 Resistance to solder heatPer EIA-364-56, Procedure 4 & 5, Level 3
 SolderabilityPer EIA RS-186-9E
 SealPer IP67

E

Sealed Tactile Switches

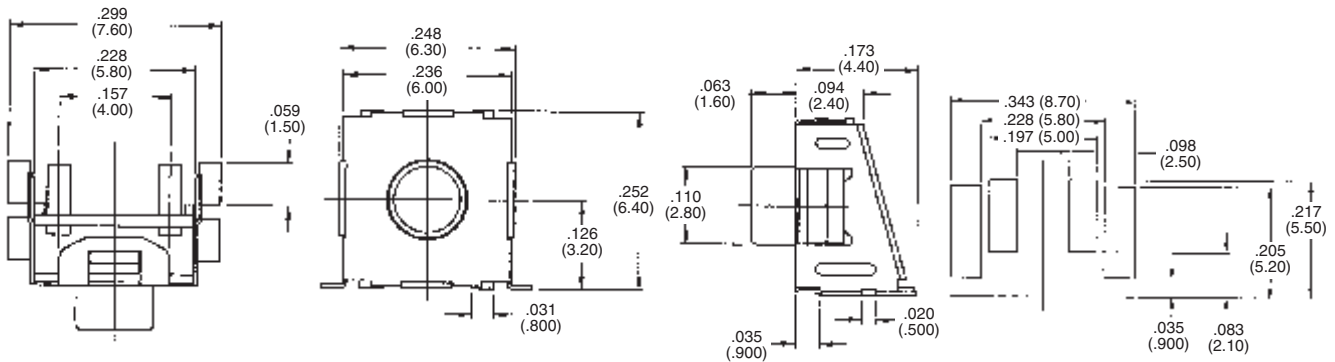

Tyco Electronics	Packaging	Actuator Height	Operating Force
1571407-1	Bulk	.063 (1.60)	260 ± 100gf
1571407-2	T&R	.063 (1.60)	260 ± 100gf

Tactile Switches, Side Actuated, Surface Mount

MATERIAL SPECIFICATIONS:

CaseNylon 4/6, UL94V-0, Black
 Stem/ActuatorNylon 4/6, UL94V-0, Black
 CoverStainless Steel
 Contact PlateStainless Steel, Silver Clad Over
 Nickel Plate
 TerminalCopper Alloy, Silver Over Nickel Plate
 Masking TapeTeflon

TYPICAL PERFORMANCE CHARACTERISTICS:

Contact Rating50mA @ 12 V DC
 Initial Contact Resistance100MilliOhms Max
 Insulation Resistance100Megaohms @ 100VDC Min.
 Dielectric Strength500 VAC for 1 minute
 Force160 (+70/-40gm)
 Travel30 (+.1/-2mm)
 LifeUp to 100,000 Cycles

ENVIRONMENTAL SPECIFICATIONS:

Operating Temperature-4° to +185°F (-20°to +85°C)
 Storage Temperature-22° to +185°F (-30°to +85°C)
 Resistance to Solder HeatPer EIA-364-56A, procedure 4 and 5,
 Level 3
 SolderabilityPer EIA-364-52, Class 2, Category 1,
 Temp. 473°F (245°C) max., time 2.5 sec.
 max., 95% min. coverage.

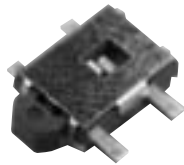
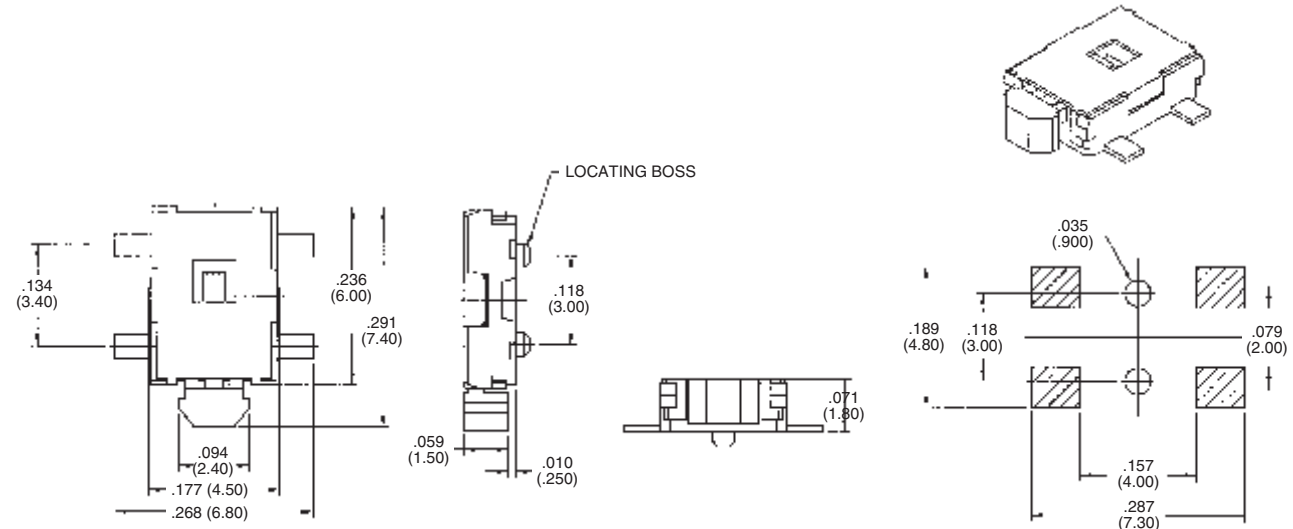

Tyco Electronics	Feature	Packaging
1571262-1	W/O Boss	Bulk
1571262-2	W/O Boss	T&R
1571262-3	with Boss	Bulk
1571262-4	with Boss	T&R

E
Side Actuated Tactile Switches

Multi-Directional Actuation

MATERIAL SPECIFICATIONS:

ContactCopper alloy - silver clad/nickel
 Case MaterialNylon - UL 94-HB, Black
 Actuator MaterialNylon - UL 94-HB, Black
 Terminals/Fixed ContactCopper alloy - plate silver clad/nickel

ENVIRONMENTAL SPECIFICATIONS

Operating Temperature-13° to 158°F (-25° to +70°C)
 Storage Temperature-40° to 185°F (-40° to +85°C)
 Solder Heat Resistance.....Per EIA-364-56A, Procedure 4 and 5, Level 3
 SolderabilityPer EIA-364-52, Class 2 Cat. 1, temp. 255° max., time 5 seconds max. 95% min. coverage

TYPICAL PERFORMANCE CHARACTERISTICS

Contact Rating20mA @15VDC
 Initial Contact Resistance.....100 Milliohms max.
 Insulation Resistance100 Megohm min.
 Dielectric Strength100 VAC for 1 min.
 Life ExpectancyUp to 50,000 Cycles
 Actuation Force500±150 gf (center push),
 200±100 gf (4-directional)
 Actuation Travel.....0.039 (1.0) ±0.012 (.3) (4-directional),
 0.315 (8.0) ±2° (4-directional)

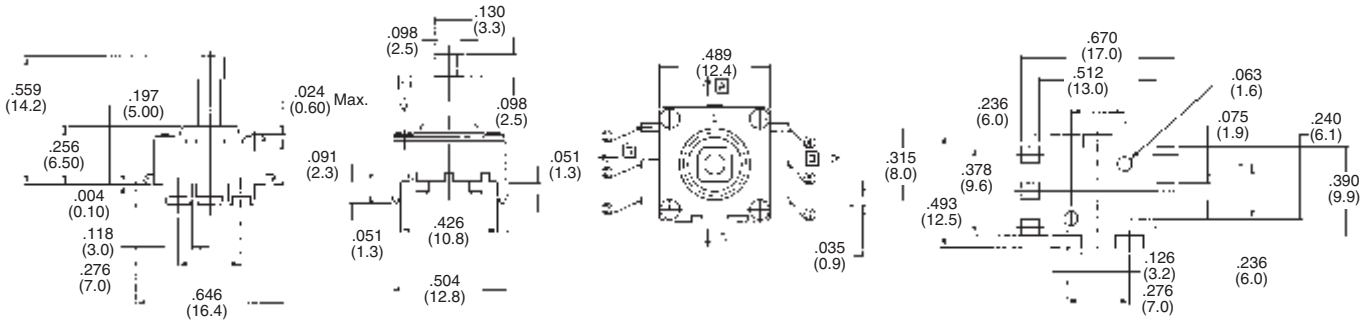

Tyco Electronics	Dimension L
1571514-1	.559 (14.2)
1571514-2	.480 (12.2)
1571514-3	.413 (10.5)

MATERIAL SPECIFICATIONS:

Contacts.....Stainless steel, plate silver clad/nickel
 Case MaterialNylon - UL 94-HB, Black
 Actuator MaterialPBT, UL 94-HB
 Terminals/Fixed ContactsCopper alloy - plate silver/nickel

Environmental Specifications

Operating Temperature-13° to 158°F (-25° to +70°C)
 Storage Temperature.....-40° to 185°F (-40° to +85°C)
 Solder Heat ResistancePer EIA-364-56A, Procedure 3, Condition B
 SolderabilityPer EIA-364-52, Class 2 Cat. 1, temp. 255° max., time 5 seconds max. 95% min. coverage

TYPICAL PERFORMANCE CHARACTERISTICS

Contact Rating20mA @15VDC
 Initial Contact Resistance100 Milliohms max.
 Insulation Resistance100 Megohm min.
 Dielectric Strength100 VAC for 1 min.
 Life ExpectancyUp to 50,000 Cycles
 Actuation Force350±100 gf (center push),
 200±70/-50 gf (4-directional)
 Actuation Travel.....0.010 (.25) ±0.008 (.2) (center push),
 0.197 (5.0) ±1° (4-directional)

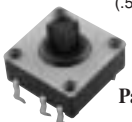
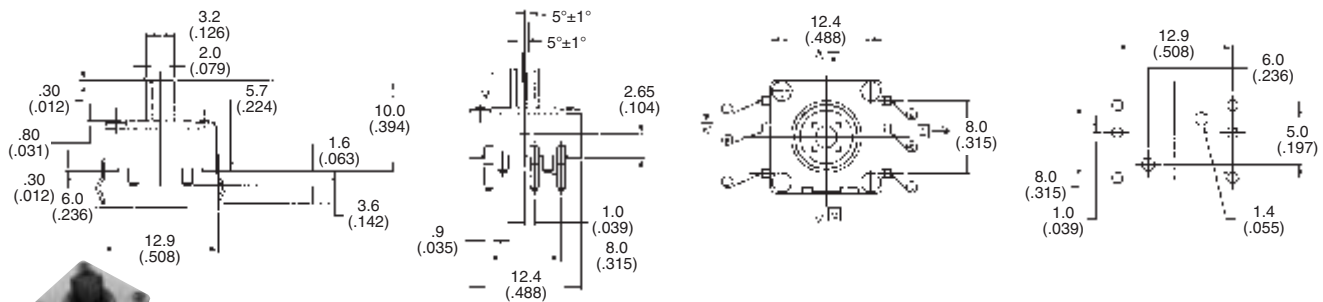

Part Number 1571515-1

Multi-Directional Switches