

**5KP-HRA Series**

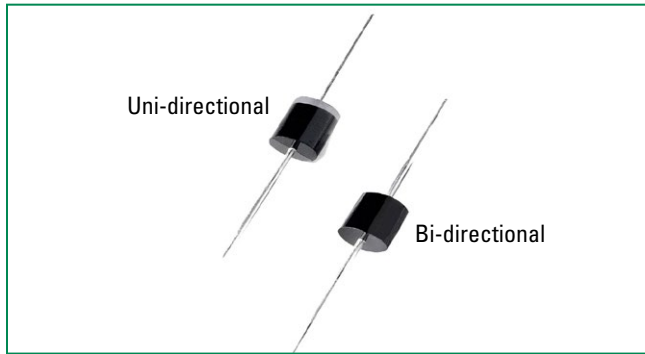

**Agency Approvals**

AGENCY	AGENCY FILE NUMBER
	E230531

**Maximum Ratings and Thermal Characteristics (T<sub>A</sub>=25°C unless otherwise noted)**

Parameter	Symbol	Value	Unit
Peak Pulse Power Dissipation by 10/1000µs Test Waveform (Fig.2) (Note 1)	P <sub>PPM</sub>	5	kW
Steady State Power Dissipation on Infinite Heat Sink at T <sub>L</sub> =75°C	P <sub>D</sub>	8.0	W
Peak Forward Surge Current, 8.3ms Single Half Sine Wave Unidirectional Only (Note 2)	I <sub>FSM</sub>	400	A
Maximum Instantaneous Forward Voltage at 100A for Unidirectional Only (Note 3)	V <sub>F</sub>	3.5/5.0	V
Operating Junction and Storage Temperature Range	T <sub>J</sub> , T <sub>STG</sub>	-55 to 175	°C
Typical Thermal Resistance Junction to Lead	R <sub>θJL</sub>	8.0	°C/W
Typical Thermal Resistance Junction to Ambient	R <sub>θJA</sub>	40	°C/W

**Notes:**

1. Non-repetitive current pulse per Fig. 4 and derated above T<sub>J</sub> (initial) =25°C per Fig. 3.
2. Measured on 8.3ms single half sine wave or equivalent square wave, duty cycle=4 per minute maximum.
3. V<sub>F</sub> < 3.5V for single die parts and V<sub>F</sub> < 5.0V for stacked-die parts.

**Functional Diagram**

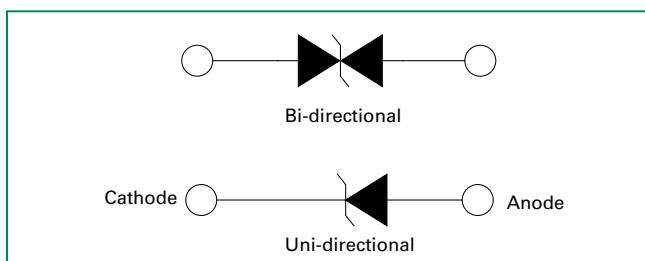

**Description**

The 5KP-HRA High Reliability Series is designed specifically to protect sensitive electronic equipment from voltage transients induced by lightning and other transient voltage events.

**Features**

- 5 kW peak pulse capability at 10/1000µs waveform, repetition rate (duty cycles):0.01 %
- Glass passivated chip junction in P600 package
- Fast response time: typically less than 1.0ps from 0 Volts to V<sub>BR</sub> min
- Excellent clamping capability
- Typical failure mode is short from over-specified voltage or current
- Whisker test is conducted based on JEDEC JESD201A per its table 4a and 4c
- IEC-61000-4-2 ESD 30kV(Air), 30kV (Contact)
- EFT protection of data lines in accordance with IEC 61000-4-4
- Low incremental surge resistance
- Typical I<sub>R</sub> less than 2µA when V<sub>BR</sub> min>12V
- High temperature to reflow soldering guaranteed: 260°C/10sec / 0.375" (9.5mm) lead length, 5 lbs., (2.3kg) tension
- V<sub>BR</sub> @ T<sub>J</sub> = V<sub>BR</sub> @25°C x (1 + α T x (T<sub>J</sub> - 25)) (α T: Temperature Coefficient, typical value is 0.1 %)
- UL Recognized compound meeting flammability rating V-0
- Lead-free matte tin plated package
- Halogen free and RoHS compliant
- Pb-free E3 indicates that 2nd level interconnect is Pb-free and the terminal finish material is tin(Sn) (IPC/JEDEC J-STD-609A.01)

**Applications**

TVS Components are ideal for the protection of I/O interfaces, V<sub>CC</sub> bus and other vulnerable circuits used in telecom, computer, industrial and consumer electronic applications.

### Electrical Characteristics ( $T_A=25^\circ\text{C}$ unless otherwise noted)

Part Number (Uni)	Part Number (Bi)	Reverse Stand off Voltage $V_R$ (Volts)	Breakdown Voltage $V_{BR}$ (Volts) @ $I_T$		Test Current $I_T$ (mA)	Maximum Clamping Voltage $V_C$ @ $I_{PP}$ (V)	Maximum Peak Pulse Current $I_{PP}$ (A)	Maximum Reverse Leakage $I_R$ @ $V_R$ ( $\mu\text{A}$ )	Agency Recognition 
			MIN	MAX					
5KP5.0A-HRA	5KP5.0CA-HRA	5.0	6.40	7.00	50	9.2	554.3	5000	X
5KP6.0A-HRA	5KP6.0CA-HRA	6.0	6.67	7.37	50	10.3	495.1	5000	X
5KP6.5A-HRA	5KP6.5CA-HRA	6.5	7.22	7.98	50	11.2	455.4	2000	X
5KP7.0A-HRA	5KP7.0CA-HRA	7.0	7.78	8.60	50	12.0	425.0	1000	X
5KP7.5A-HRA	5KP7.5CA-HRA	7.5	8.33	9.21	5	12.9	395.3	250	X
5KP8.0A-HRA	5KP8.0CA-HRA	8.0	8.89	9.83	5	13.6	375.0	150	X
5KP8.5A-HRA	5KP8.5CA-HRA	8.5	9.44	10.40	5	14.4	354.2	50	X
5KP9.0A-HRA	5KP9.0CA-HRA	9.0	10.00	11.10	5	15.4	331.2	20	X
5KP10A-HRA	5KP10CA-HRA	10.0	11.10	12.30	5	17.0	300.0	15	X
5KP11A-HRA	5KP11CA-HRA	11.0	12.20	13.50	5	18.2	280.2	2	X
5KP12A-HRA	5KP12CA-HRA	12.0	13.30	14.70	5	19.9	256.3	2	X
5KP13A-HRA	5KP13CA-HRA	13.0	14.40	15.90	5	21.5	237.2	2	X
5KP14A-HRA	5KP14CA-HRA	14.0	15.60	17.20	5	23.2	219.8	2	X
5KP15A-HRA	5KP15CA-HRA	15.0	16.70	18.50	5	24.4	209.0	2	X
5KP16A-HRA	5KP16CA-HRA	16.0	17.80	19.70	5	26.0	196.2	2	X
5KP17A-HRA	5KP17CA-HRA	17.0	18.90	20.90	5	27.6	184.8	2	X
5KP18A-HRA	5KP18CA-HRA	18.0	20.00	22.10	5	29.2	174.7	2	X
5KP20A-HRA	5KP20CA-HRA	20.0	22.20	24.50	5	32.4	157.4	2	X
5KP22A-HRA	5KP22CA-HRA	22.0	24.00	26.90	5	35.5	143.7	2	X
5KP24A-HRA	5KP24CA-HRA	24.0	26.70	29.50	5	38.9	131.1	2	X
5KP26A-HRA	5KP26CA-HRA	26.0	28.90	31.90	5	42.1	121.1	2	X
5KP28A-HRA	5KP28CA-HRA	28.0	31.10	34.40	5	45.4	112.3	2	X
5KP30A-HRA	5KP30CA-HRA	30.0	33.30	36.80	5	48.4	105.4	2	X
5KP33A-HRA	5KP33CA-HRA	33.0	36.70	40.60	5	53.3	95.7	2	X
5KP36A-HRA	5KP36CA-HRA	36.0	40.00	44.20	5	58.1	87.8	2	X
5KP40A-HRA	5KP40CA-HRA	40.0	44.40	49.10	5	64.5	79.1	2	X
5KP43A-HRA	5KP43CA-HRA	43.0	47.80	52.80	5	69.4	73.5	2	X
5KP45A-HRA	5KP45CA-HRA	45.0	50.00	55.30	5	72.7	70.2	2	X
5KP48A-HRA	5KP48CA-HRA	48.0	53.30	58.90	5	77.4	65.9	2	X
5KP51A-HRA	5KP51CA-HRA	51.0	56.70	62.70	5	82.4	61.9	2	X
5KP54A-HRA	5KP54CA-HRA	54.0	60.00	66.30	5	87.1	58.6	2	X
5KP58A-HRA	5KP58CA-HRA	58.0	64.40	71.20	5	93.6	54.5	2	X
5KP60A-HRA	5KP60CA-HRA	60.0	66.70	73.70	5	96.8	52.7	2	X
5KP64A-HRA	5KP64CA-HRA	64.0	71.10	78.60	5	103.0	49.5	2	X
5KP70A-HRA	5KP70CA-HRA	70.0	77.80	86.00	5	113.0	45.1	2	X
5KP75A-HRA	5KP75CA-HRA	75.0	83.30	92.10	5	121.0	42.1	2	X
5KP78A-HRA	5KP78CA-HRA	78.0	86.70	95.80	5	126.0	40.5	2	X
5KP85A-HRA	5KP85CA-HRA	85.0	94.40	104.00	5	137.0	37.2	2	X
5KP90A-HRA	5KP90CA-HRA	90.0	100.00	111.00	5	146.0	34.9	2	X
5KP100A-HRA	5KP100CA-HRA	100.0	110.00	123.00	5	162.0	31.5	2	X
5KP110A-HRA	5KP110CA-HRA	110.0	122.00	135.00	5	177.0	28.8	2	X
5KP120A-HRA	5KP120CA-HRA	120.0	133.00	147.00	5	193.0	26.4	2	X
5KP130A-HRA	5KP130CA-HRA	130.0	144.00	159.00	5	209.0	24.4	2	X
5KP150A-HRA	5KP150CA-HRA	150.0	167.00	185.00	5	243.0	21.0	2	X
5KP160A-HRA	5KP160CA-HRA	160.0	178.00	197.00	5	259.0	19.7	2	X
5KP170A-HRA	5KP170CA-HRA	170.0	189.00	209.00	5	275.0	18.5	2	X
5KP180A-HRA	5KP180CA-HRA	180.0	200.00	221.00	5	292.0	17.5	2	X
5KP190A-HRA	5KP190CA-HRA	190.0	211.00	233.00	5	310.0	16.5	2	-
5KP200A-HRA	5KP200CA-HRA	200.0	222.00	246.00	5	329.2	15.5	2	X
5KP210A-HRA	5KP210CA-HRA	210.0	233.00	258.00	5	349.5	14.6	2	-
5KP220A-HRA	5KP220CA-HRA	220.0	244.00	270.00	5	371.1	13.7	2	X

Note:

1. For bidirectional type having  $V_R$  of 10 volts and less, the  $I_T$  limit is double.

**Screen Process**

<b>100% Vision Inspection</b>	MIL-STD-750 method 2074
<b>100% High Temperature Storage Life (168hrs,175°C)</b>	MIL-STD-750 method 1031
<b>100% Temperature Cycle Test (-55 to 150°C, 20 cycles, dwell time 15 min)</b>	MIL-STD-750 method 1051
<b>100% Surge Test (2x)</b>	MIL-STD-750 method 4066
<b>100% HTRB 150°C Bias=VR(80% breakdown voltage, 96hrs, and each direction 96hrs for Bi-directional products)</b>	MIL-STD-750 method 1038
<b>Final Electrical Test( 100% 3 sigma limit, 100% dynamic test and PAT limit)</b>	MIL-STD-750 method 4016.4021.4011

Note: Up-screen program can be specified by customer's request via contacting Littelfuse service

**I-V Curve Characteristics**

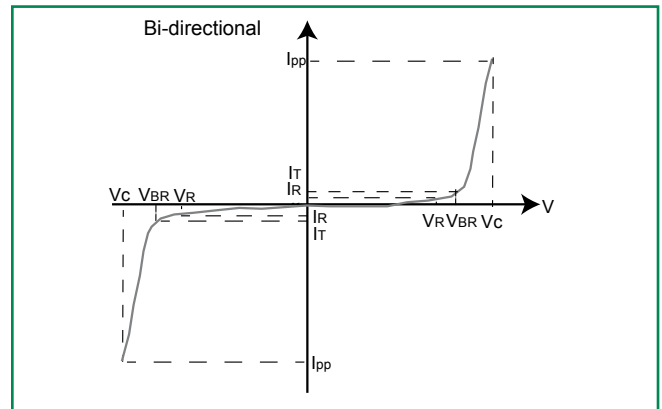
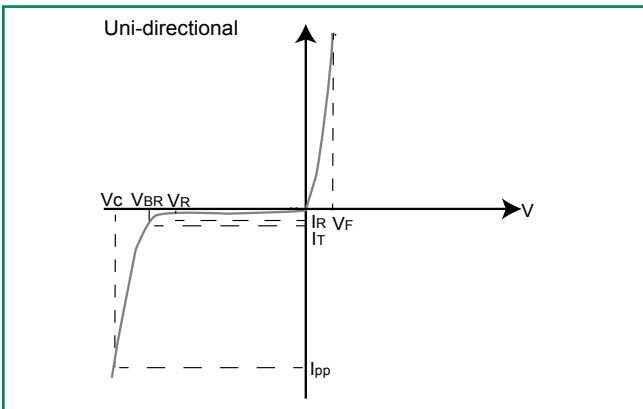

- P<sub>ppm</sub> Peak Pulse Power Dissipation** – Max power dissipation
- V<sub>R</sub> Stand-off Voltage** – Maximum voltage that can be applied to the TVS without operation
- V<sub>BR</sub> Breakdown Voltage** – Maximum voltage that flows though the TVS at a specified test current (I<sub>T</sub>)
- V<sub>C</sub> Clamping Voltage** – Peak voltage measured across the TVS at a specified I<sub>ppm</sub> (peak impulse current)
- I<sub>R</sub> Reverse Leakage Current** – Current measured at V<sub>R</sub>
- V<sub>F</sub> Forward Voltage Drop for Uni-directional**

**Ratings and Characteristic Curves (T<sub>A</sub>=25°C unless otherwise noted)**

**Figure 1 - TVS Transients Clamping Waveform**

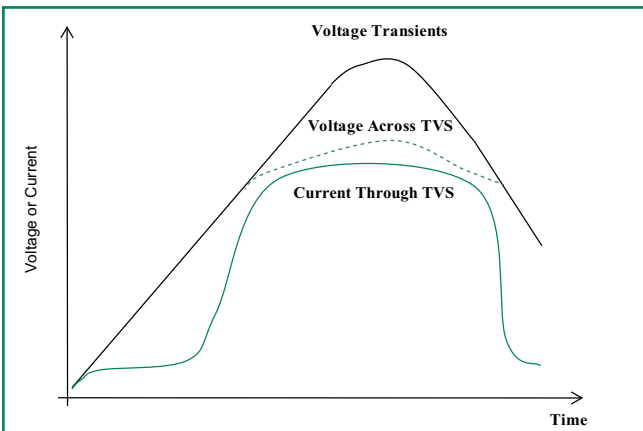

**Figure 2 - Peak Pulse Power Rating Curve**

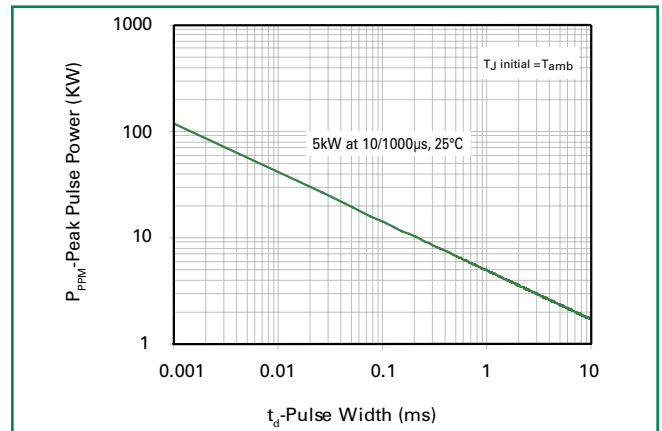

**Figure 3 - Peak Pulse Power Derating Curve**

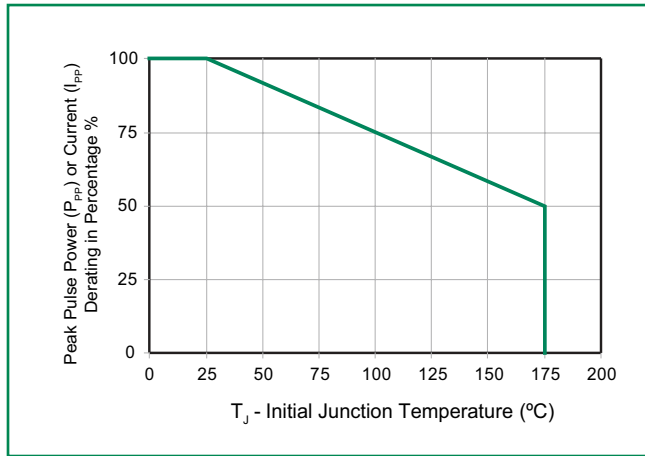

**Figure 4 - Pulse Waveform**

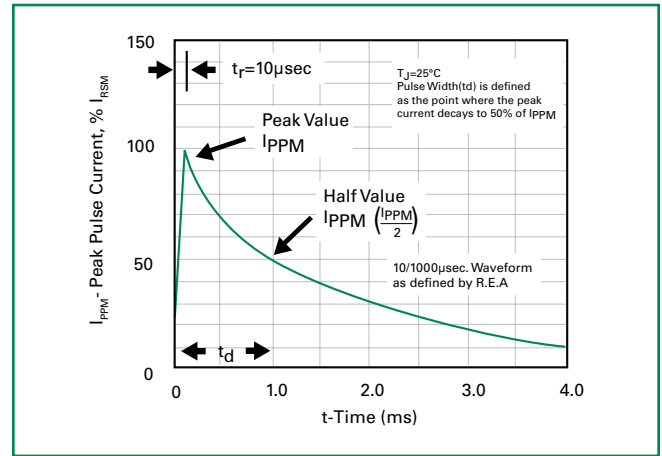

**Figure 5 - Typical Junction Capacitance**

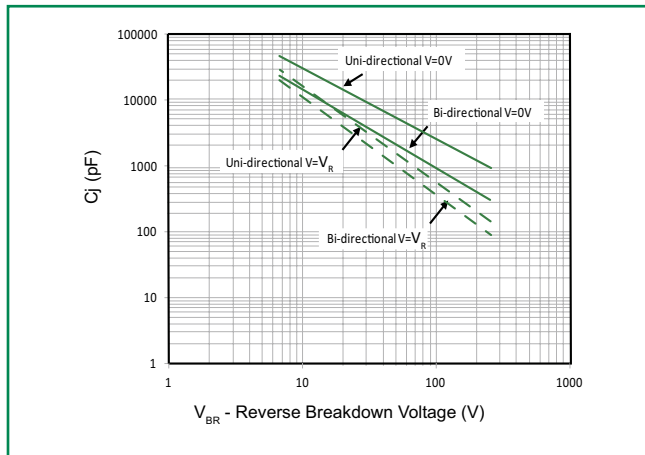

**Figure 6 - Typical Transient Thermal Impedance**

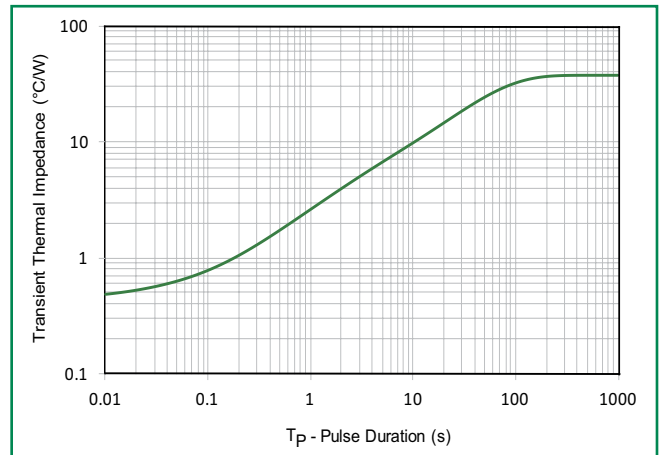

**Figure 7 - Maximum Non-Repetitive Peak Forward Surge Current Uni-Directional Only**

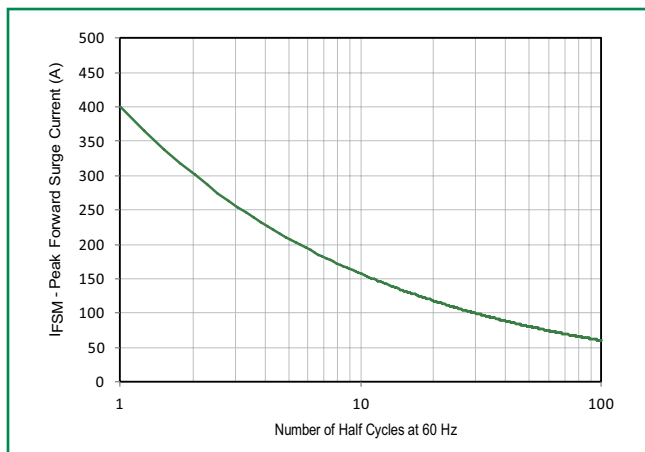

**Figure 8 - Peak Forward Voltage Drop vs Peak Forward Current (Typical Values)**

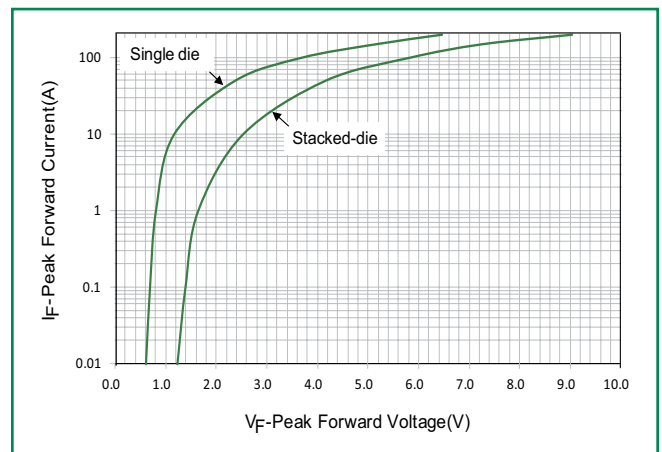

**Physical Specifications**

<b>Weight</b>	0.07oz., 2.1g
<b>Case</b>	P600 molded plastic body over passivated junction.
<b>Polarity</b>	Color band denotes the cathode except Bipolar.
<b>Terminal</b>	Matte Tin axial leads, solderable per JESD22-B102.

**Environmental Specifications**

<b>High Temp. Storage</b>	JESD22-A103
<b>HTRB</b>	JESD22-A108
<b>Temperature Cycling</b>	JESD22-A104
<b>H3TRB</b>	JESD22-A101
<b>RSH</b>	JESD22-B106

**Dimensions**

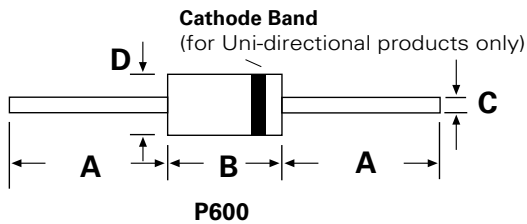

Dimensions	Inches		Millimeters	
	Min	Max	Min	Max
A	1.000	-	25.40	-
B	0.340	0.360	8.60	9.10
C	0.048	0.054	1.22	1.36
D	0.340	0.360	8.60	9.10

**Part Numbering System**

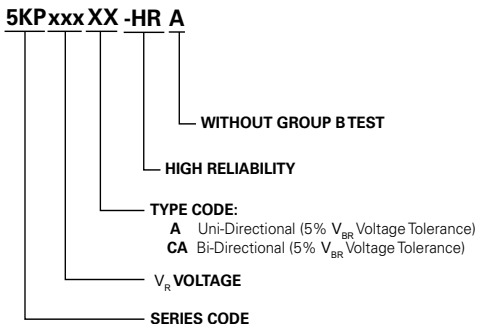

**Part Marking System**

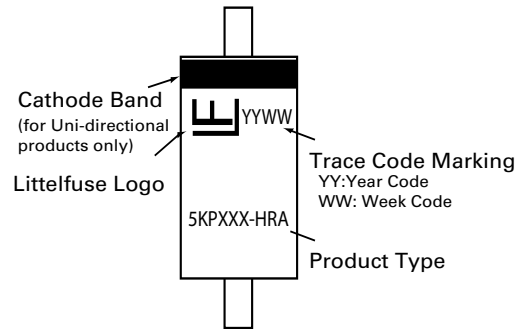

**Packing Options**

Part Number	Component Package	Quantity	Packaging Option	Packaging Specification
5KPxxxXX-HRA	P600	800	Tape & Reel	EIA STD RS-296

**Tape and Reel Specification**

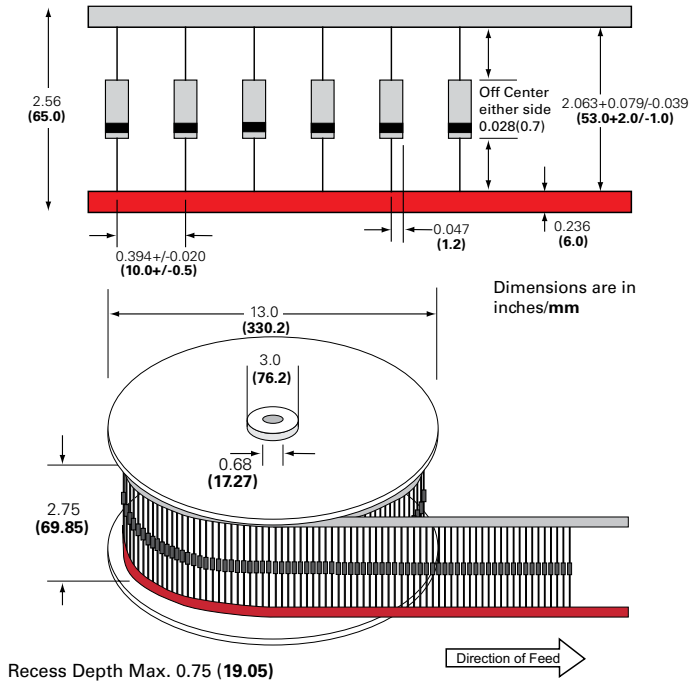

**RTCA/DO-160G Wave 3**

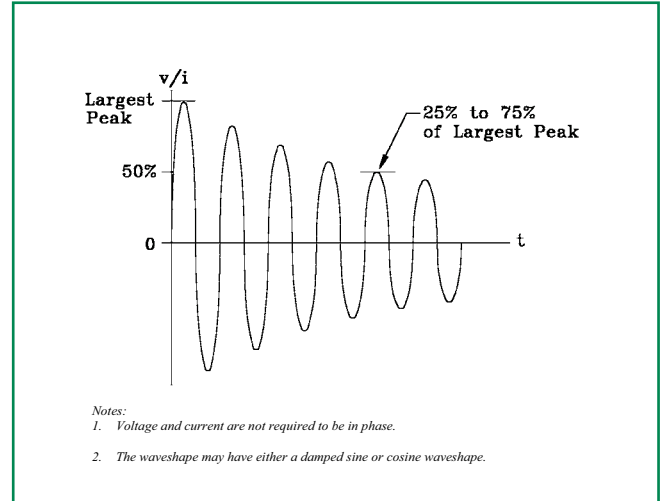

**RTCA/DO-160G Wave 4 and Wave 5**

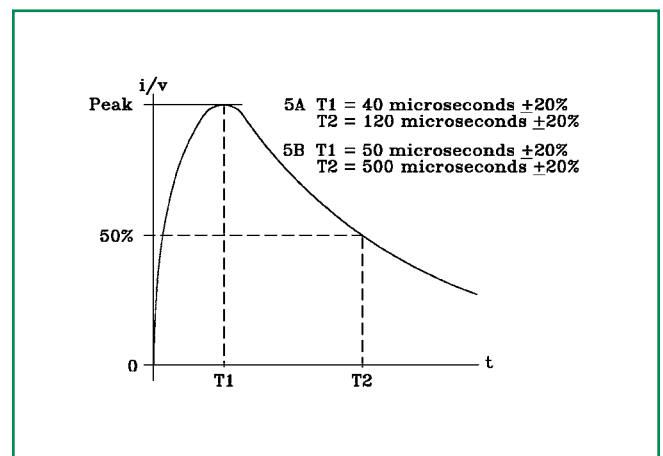
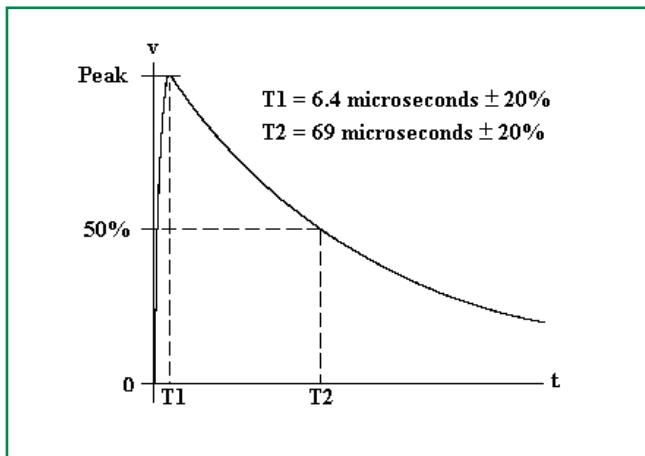

### Pin Injection Protection Per RTCA/DO-160G

Part Number (Uni)	Part Number (Bi)	25C								70C						120C					
		Wave 3	Wave 4 (6.4/69us)				Wave 5a (40/120us)				Wave 3	Wave 4 (6.4/69us)				Wave 5a (40/120us)					
			L5	L3	L4	L5	L3	L4	L5	L5		L3	L4	L5	L3	L4	L5	L3	L4		
		128A	60A	150A	320A	300A	750A	1600A	128A	60A	150A	320A	300A	750A	128A	60A	150A	320A	300A	750A	
5KP5.0A-HRA	5KP5.0CA-HRA	pass	pass	pass	pass	pass	pass	pass	pass	pass	pass	pass	pass	pass	pass	pass	pass	pass	pass	pass	
5KP6.0A-HRA	5KP6.0CA-HRA	pass	pass	pass	pass	pass	pass	pass	pass	pass	pass	pass	pass	pass	pass	pass	pass	pass	pass	pass	
5KP6.5A-HRA	5KP6.5CA-HRA	pass	pass	pass	pass	pass	pass	pass	pass	pass	pass	pass	pass	pass	pass	pass	pass	pass	pass	pass	
5KP7.0A-HRA	5KP7.0CA-HRA	pass	pass	pass	pass	pass	pass	pass	pass	pass	pass	pass	pass	pass	pass	pass	pass	pass	pass	pass	
5KP7.5A-HRA	5KP7.5CA-HRA	pass	pass	pass	pass	pass	pass	-	pass	pass	pass	pass	pass	pass	pass	pass	pass	pass	pass	pass	
5KP8.0A-HRA	5KP8.0CA-HRA	pass	pass	pass	pass	pass	pass	-	pass	pass	pass	pass	pass	pass	pass	pass	pass	pass	pass	pass	
5KP8.5A-HRA	5KP8.5CA-HRA	pass	pass	pass	pass	pass	pass	-	pass	pass	pass	pass	pass	pass	pass	pass	pass	pass	pass	pass	
5KP9.0A-HRA	5KP9.0CA-HRA	pass	pass	pass	pass	pass	pass	-	pass	pass	pass	pass	pass	pass	pass	pass	pass	pass	pass	pass	
5KP10A-HRA	5KP10CA-HRA	pass	pass	pass	pass	pass	pass	-	pass	pass	pass	pass	pass	pass	pass	pass	pass	pass	pass	pass	
5KP11A-HRA	5KP11CA-HRA	pass	pass	pass	pass	pass	pass	-	pass	pass	pass	pass	pass	pass	pass	pass	pass	pass	pass	pass	
5KP12A-HRA	5KP12CA-HRA	pass	pass	pass	pass	pass	pass	-	pass	pass	pass	pass	pass	pass	pass	pass	pass	pass	pass	-	
5KP13A-HRA	5KP13CA-HRA	pass	pass	pass	pass	pass	pass	-	pass	pass	pass	pass	pass	pass	pass	pass	pass	pass	pass	-	
5KP14A-HRA	5KP14CA-HRA	pass	pass	pass	pass	pass	pass	-	pass	pass	pass	pass	pass	pass	pass	pass	pass	pass	pass	-	
5KP15A-HRA	5KP15CA-HRA	pass	pass	pass	pass	pass	pass	-	pass	pass	pass	pass	pass	pass	pass	pass	pass	pass	pass	-	
5KP16A-HRA	5KP16CA-HRA	pass	pass	pass	pass	pass	-	-	pass	pass	pass	pass	pass	-	pass	pass	pass	pass	pass	-	
5KP17A-HRA	5KP17CA-HRA	pass	pass	pass	pass	pass	-	-	pass	pass	pass	pass	pass	-	pass	pass	pass	pass	pass	-	
5KP18A-HRA	5KP18CA-HRA	pass	pass	pass	pass	pass	-	-	pass	pass	pass	pass	pass	-	pass	pass	pass	pass	pass	-	
5KP20A-HRA	5KP20CA-HRA	pass	pass	pass	pass	pass	-	-	pass	pass	pass	pass	pass	-	pass	pass	pass	pass	-	-	
5KP22A-HRA	5KP22CA-HRA	pass	pass	pass	pass	pass	-	-	pass	pass	pass	pass	-	-	pass	pass	pass	pass	-	-	
5KP24A-HRA	5KP24CA-HRA	pass	pass	pass	pass	pass	-	-	pass	pass	pass	pass	-	-	pass	pass	pass	pass	-	-	
5KP26A-HRA	5KP26CA-HRA	pass	pass	pass	pass	pass	-	-	pass	pass	pass	pass	-	-	pass	pass	pass	pass	-	-	
5KP28A-HRA	5KP28CA-HRA	pass	pass	pass	pass	pass	pass	-	pass	pass	pass	pass	-	-	pass	pass	pass	pass	-	-	
5KP30A-HRA	5KP30CA-HRA	pass	pass	pass	pass	pass	pass	-	pass	pass	pass	pass	-	-	pass	pass	pass	pass	-	-	
5KP33A-HRA	5KP33CA-HRA	pass	pass	pass	pass	-	-	-	pass	pass	pass	pass	-	-	pass	pass	pass	-	-	-	
5KP36A-HRA	5KP36CA-HRA	pass	pass	pass	pass	-	-	-	pass	pass	pass	pass	-	-	pass	pass	pass	-	-	-	
5KP40A-HRA	5KP40CA-HRA	pass	pass	pass	pass	-	-	-	pass	pass	pass	pass	-	-	pass	pass	pass	-	-	-	
5KP43A-HRA	5KP43CA-HRA	pass	pass	pass	pass	-	-	-	pass	pass	pass	pass	-	-	pass	pass	pass	-	-	-	
5KP45A-HRA	5KP45CA-HRA	pass	pass	pass	pass	-	-	-	pass	pass	pass	-	-	-	pass	pass	pass	-	-	-	
5KP48A-HRA	5KP48CA-HRA	pass	pass	pass	pass	-	-	-	pass	pass	pass	-	-	-	pass	pass	pass	-	-	-	
5KP51A-HRA	5KP51CA-HRA	pass	pass	pass	pass	-	-	-	pass	pass	-	-	-	-	pass	pass	-	-	-	-	
5KP54A-HRA	5KP54CA-HRA	pass	pass	pass	pass	-	-	-	pass	pass	-	-	-	-	pass	pass	-	-	-	-	
5KP58A-HRA	5KP58CA-HRA	pass	pass	pass	pass	-	-	-	pass	pass	-	-	-	-	pass	pass	-	-	-	-	
5KP60A-HRA	5KP60CA-HRA	pass	pass	pass	pass	-	-	-	pass	pass	-	-	-	-	pass	pass	-	-	-	-	
5KP64A-HRA	5KP64CA-HRA	pass	pass	pass	pass	-	-	-	pass	pass	-	-	-	-	pass	pass	-	-	-	-	
5KP70A-HRA	5KP70CA-HRA	pass	pass	pass	pass	-	-	-	pass	pass	-	-	-	-	pass	pass	-	-	-	-	
5KP75A-HRA	5KP75CA-HRA	pass	pass	pass	-	-	-	-	pass	pass	-	-	-	-	pass	pass	-	-	-	-	
5KP78A-HRA	5KP78CA-HRA	pass	pass	pass	-	-	-	-	pass	pass	-	-	-	-	pass	pass	-	-	-	-	
5KP85A-HRA	5KP85CA-HRA	pass	pass	pass	-	-	-	-	pass	pass	-	-	-	-	pass	pass	-	-	-	-	
5KP90A-HRA	5KP90CA-HRA	pass	pass	pass	-	-	-	-	pass	pass	-	-	-	-	pass	pass	-	-	-	-	
5KP100A-HRA	5KP100CA-HRA	pass	pass	pass	-	-	-	-	pass	pass	-	-	-	-	pass	pass	-	-	-	-	
5KP110A-HRA	5KP110CA-HRA	pass	pass	-	-	-	-	-	pass	-	-	-	-	-	pass	-	-	-	-	-	
5KP120A-HRA	5KP120CA-HRA	pass	pass	-	-	-	-	-	pass	-	-	-	-	-	pass	-	-	-	-	-	
5KP130A-HRA	5KP130CA-HRA	pass	pass	-	-	-	-	-	pass	-	-	-	-	-	pass	-	-	-	-	-	
5KP150A-HRA	5KP150CA-HRA	pass	pass	-	-	-	-	-	pass	-	-	-	-	-	pass	-	-	-	-	-	
5KP160A-HRA	5KP160CA-HRA	pass	pass	-	-	-	-	-	pass	-	-	-	-	-	pass	-	-	-	-	-	
5KP170A-HRA	5KP170CA-HRA	pass	pass	-	-	-	-	-	pass	-	-	-	-	-	pass	-	-	-	-	-	
5KP180A-HRA	5KP180CA-HRA	pass	pass	-	-	-	-	-	pass	-	-	-	-	-	pass	-	-	-	-	-	
5KP190A-HRA	5KP190CA-HRA	pass	pass	-	-	-	-	-	pass	-	-	-	-	-	pass	-	-	-	-	-	
5KP200A-HRA	5KP200CA-HRA	pass	pass	-	-	-	-	-	pass	-	-	-	-	-	pass	-	-	-	-	-	
5KP210A-HRA	5KP210CA-HRA	pass	pass	-	-	-	-	-	pass	-	-	-	-	-	pass	-	-	-	-	-	
5KP220A-HRA	5KP220CA-HRA	pass	pass	-	-	-	-	-	pass	-	-	-	-	-	pass	-	-	-	-	-	

Note:

1. L1 = Level1, L2 = Level 2, L3 = Level 3, L4 = Level 4, L5 = Level 5

# Mouser Electronics

Authorized Distributor

Click to View Pricing, Inventory, Delivery & Lifecycle Information:

## Littelfuse:

[5KP9.0A-HRA](#) [5KP10A-HRA](#) [5KP6.0A-HRA](#) [5KP7.5A-HRA](#) [5KP8.5A-HRA](#) [5KP78CA-HRA](#) [5KP26CA-HRA](#)  
[5KP150A-HRA](#) [5KP160A-HRA](#) [5KP170A-HRA](#) [5KP90CA-HRA](#) [5KP110A-HRA](#) [5KP9.0CA-HRA](#) [5KP90A-HRA](#)  
[5KP8.5CA-HRA](#) [5KP20CA-HRA](#) [5KP6.5CA-HRA](#) [5KP16CA-HRA](#) [5KP10CA-HRA](#) [5KP190A-HRA](#) [5KP70CA-HRA](#)  
[5KP190CA-HRA](#) [5KP6.0CA-HRA](#) [5KP7.0CA-HRA](#) [5KP30A-HRA](#) [5KP100CA-HRA](#) [5KP12CA-HRA](#) [5KP36CA-HRA](#)  
[5KP40CA-HRA](#) [5KP8.0A-HRA](#) [5KP33CA-HRA](#) [5KP220CA-HRA](#) [5KP150CA-HRA](#) [5KP8.0CA-HRA](#) [5KP40A-HRA](#)  
[5KP48A-HRA](#) [5KP51CA-HRA](#) [5KP58A-HRA](#) [5KP180CA-HRA](#) [5KP5.0A-HRA](#) [5KP180A-HRA](#) [5KP13CA-HRA](#)  
[5KP75A-HRA](#) [5KP200A-HRA](#) [5KP5.0CA-HRA](#) [5KP7.5CA-HRA](#) [5KP11A-HRA](#) [5KP28CA-HRA](#) [5KP220A-HRA](#)  
[5KP26A-HRA](#) [5KP54CA-HRA](#) [5KP210CA-HRA](#) [5KP51A-HRA](#) [5KP58CA-HRA](#) [5KP130CA-HRA](#) [5KP45A-HRA](#)  
[5KP22A-HRA](#) [5KP24A-HRA](#) [5KP28A-HRA](#) [5KP33A-HRA](#) [5KP60A-HRA](#) [5KP70A-HRA](#) [5KP120CA-HRA](#)  
[5KP200CA-HRA](#) [5KP130A-HRA](#) [5KP210A-HRA](#) [5KP15CA-HRA](#) [5KP75CA-HRA](#) [5KP85A-HRA](#) [5KP24CA-HRA](#)  
[5KP100A-HRA](#) [5KP22CA-HRA](#) [5KP160CA-HRA](#) [5KP17A-HRA](#) [5KP30CA-HRA](#) [5KP64A-HRA](#) [5KP170CA-HRA](#)  
[5KP14CA-HRA](#) [5KP13A-HRA](#) [5KP85CA-HRA](#) [5KP110CA-HRA](#) [5KP12A-HRA](#) [5KP48CA-HRA](#) [5KP120A-HRA](#)  
[5KP20A-HRA](#) [5KP16A-HRA](#) [5KP45CA-HRA](#) [5KP64CA-HRA](#) [5KP14A-HRA](#) [5KP18CA-HRA](#) [5KP54A-HRA](#) [5KP15A-](#)  
[HRA](#) [5KP7.0A-HRA](#) [5KP11CA-HRA](#) [5KP43CA-HRA](#) [5KP60CA-HRA](#) [5KP78A-HRA](#) [5KP17CA-HRA](#) [5KP6.5A-HRA](#)  
[5KP18A-HRA](#)