

SKKT 570, SKKH 570



SEMIPACK[®] 5

Thyristor / Diode Modules

SKKT 570

SKKH 570

Features

- Heat transfer through aluminium nitride ceramic insulated metal baseplate
- Precious metal pressure contacts for high reliability
- Thyristor with amplifying gate
- UL recognized, file no. E63532

Typical Applications*

- AC motor softstarters
- Input converters for AC inverter drives
- DC motor control (e.g. for machine tools)
- Temperature control (e.g. for ovens, chemical, processes)
- Professionals light dimming (studios, theaters)

1) see assembly instructions

2) screws must be lubricated

V_{RSM} V	V_{RRM}, V_{DRM} V	$I_{TRMS} = 1000$ A (maximum value for continuous operation) $I_{TAV} = 570$ A (sin. 180; $T_c = 85$ °C)	
1300	1200	SKKT 570/12 E	SKKH 570/12 E
1700	1600	SKKT 570/16 E	SKKH 570/16 E
1900	1800	SKKT 570/18 E	SKKH 570/18 E

Symbol	Conditions	Values	Units
I_{TAV}	sin. 180; $T_c = 85$ (100) °C;	570 (435)	A
I_{TSM}	$T_{vj} = 25$ °C; 10 ms $T_{vj} = 135$ °C; 10 ms	19000 15500	A
i^2t	$T_{vj} = 25$ °C; 8,3 .. 10 ms $T_{vj} = 135$ °C; 8,3 ... 10 ms	1805000 1201250	A ² s A ² s
V_T	$T_{vj} = 25$ °C; $I_T = 1700$ A	max. 1,44	V
$V_{T(TO)}$	$T_{vj} = 135$ °C	max. 0,78	V
r_T	$T_{vj} = 135$ °C	max. 0,32	mΩ
I_{DD}, I_{RD}	$T_{vj} = 135$ °C; $V_{RD} = V_{RRM}; V_{DD} = V_{DRM}$	max. 225	mA
t_{gd}	$T_{vj} = 25$ °C; $I_G = 1$ A; $di_G/dt = 1$ A/μs	1	μs
t_{gr}	$V_D = 0,67 * V_{DRM}$	2	μs
$(di/dt)_{cr}$	$T_{vj} = 135$ °C	max. 250	A/μs
$(dv/dt)_{cr}$	$T_{vj} = 135$ °C	max. 1000	V/μs
t_q	$T_{vj} = 135$ °C ,	100...200	μs
I_H	$T_{vj} = 25$ °C; typ. / max.	150 / 500	mA
I_L	$T_{vj} = 25$ °C; $R_G = 33$ Ω; typ. / max.	300 / 2000	mA
V_{GT}	$T_{vj} = 25$ °C; d.c.	min. 3	V
I_{GT}	$T_{vj} = 25$ °C; d.c.	min. 200	mA
V_{GD}	$T_{vj} = 135$ °C; d.c.	max. 0,25	V
I_{GD}	$T_{vj} = 135$ °C; d.c.	max. 10	mA
$R_{th(j-c)}$	cont.; per thyristor / per module	0,069 / 0,034	K/W
$R_{th(j-c)}$	sin. 180°; per thyristor / per module	0,072 / 0,036	K/W
$R_{th(j-c)}$	rec. 120°; per thyristor / per module	0,077 / 0,038	K/W
$R_{th(c-s)}$	per thyristor / per module	0,02 / 0,01	K/W
T_{vj}		- 40 ... + 135	°C
T_{stg}		- 40 ... + 125	°C
V_{isol}	a.c. 50 Hz; r.m.s.; 1 s / 1 min.	3600 / 3000	V~
M_s	to heatsink	5 ± 15% ¹⁾	Nm
M_t	to terminals	12 ± 15% ²⁾	Nm
a		5 * 9,81	m/s ²
m	approx.	1400	g
Case	SKKT SKKH	A 60b A 66b	

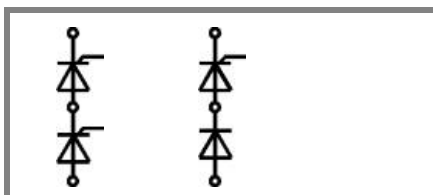

SKKT

SKKH

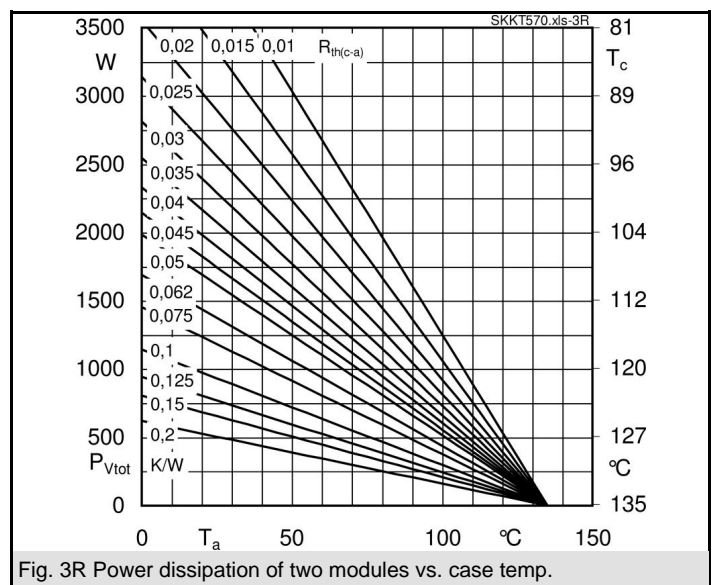
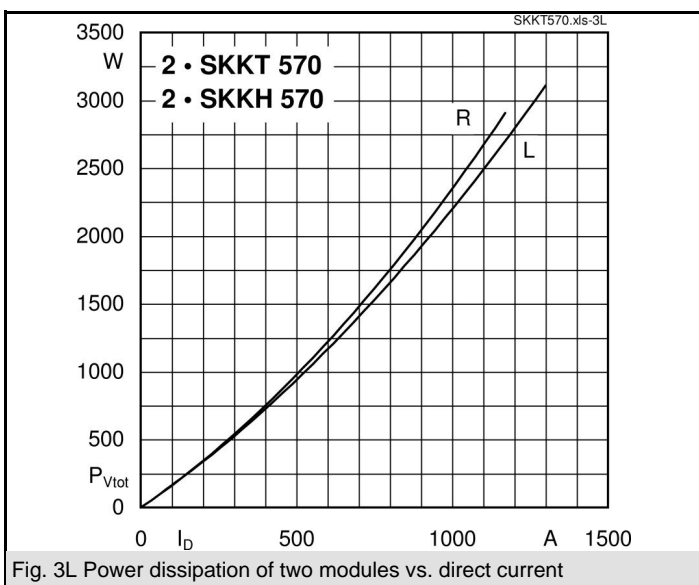
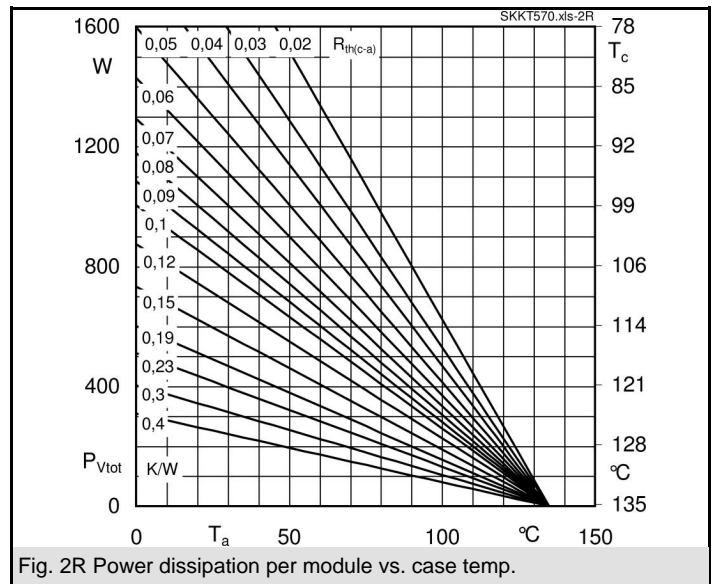
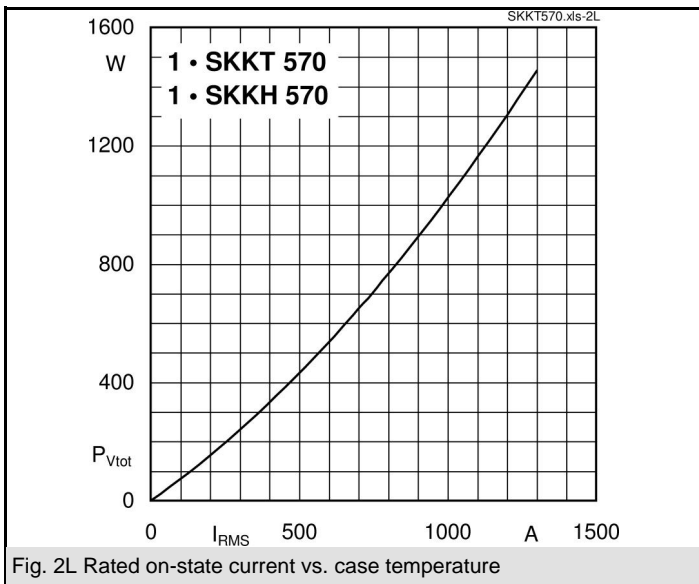
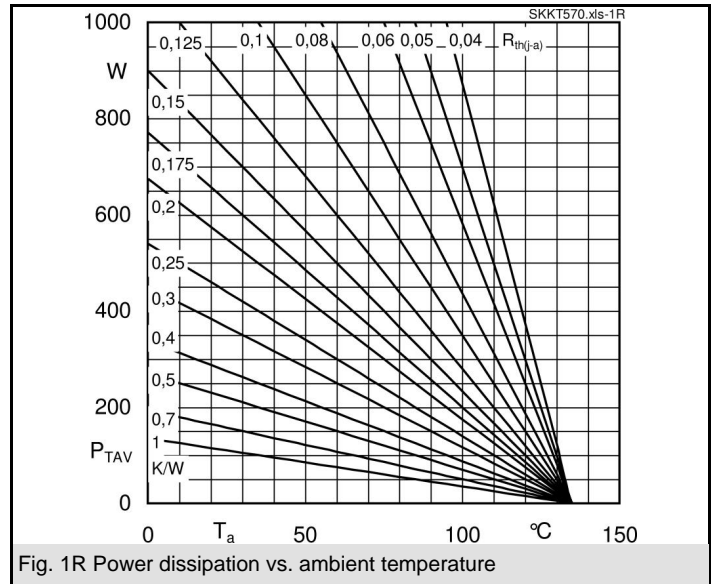
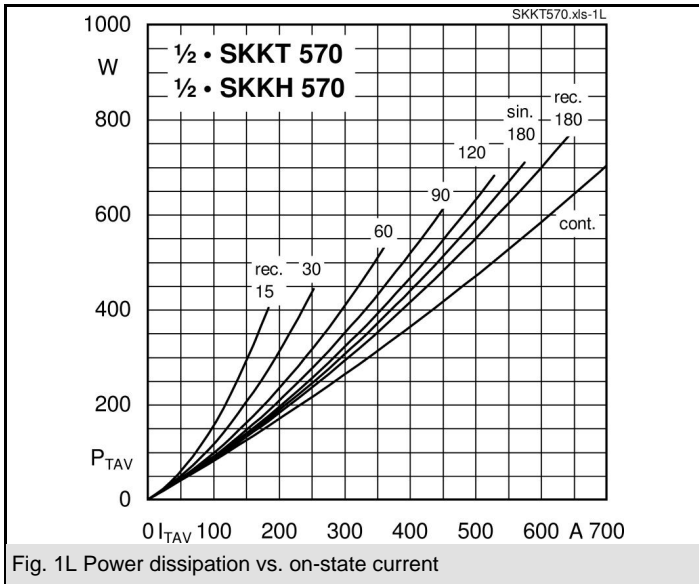

SKKT 570, SKKH 570

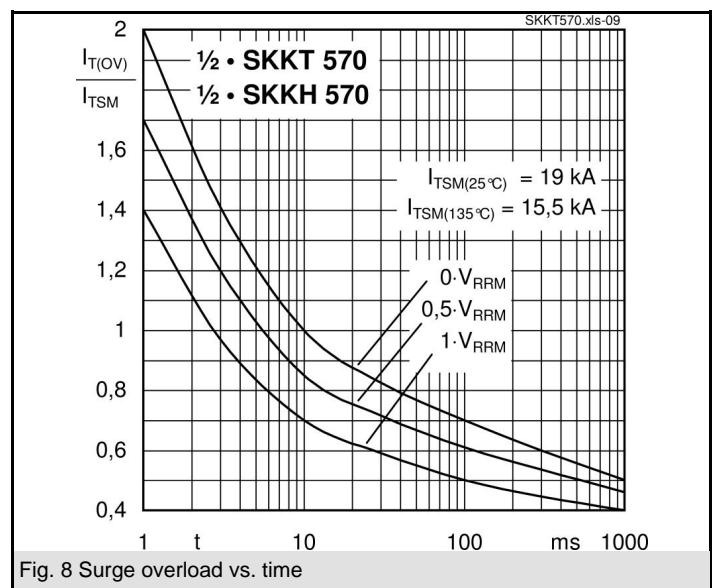
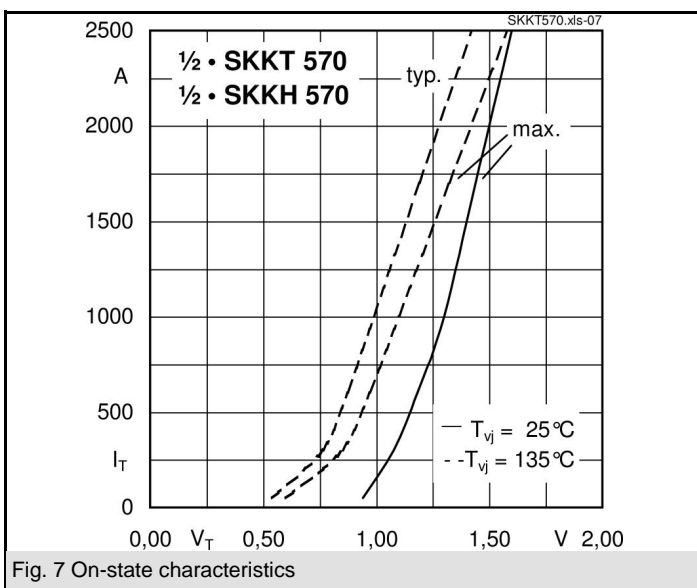
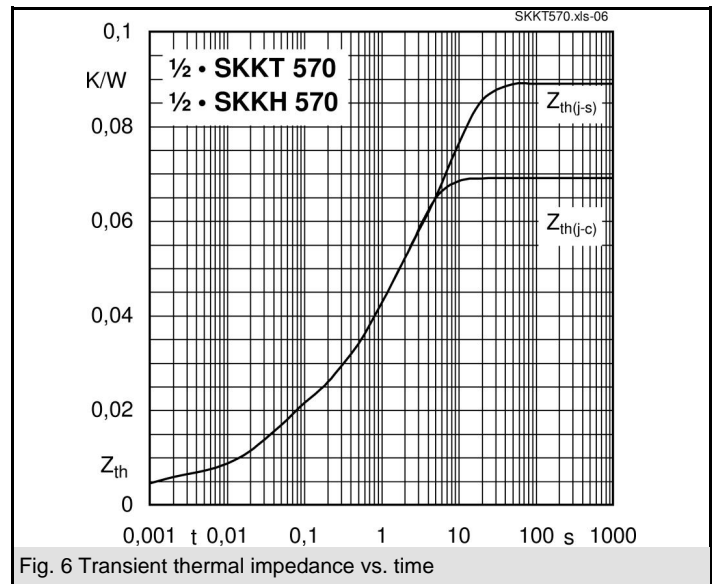
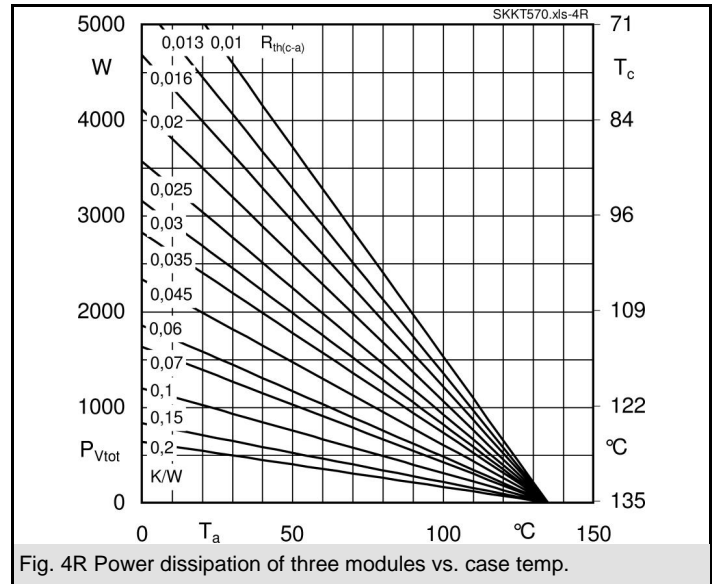
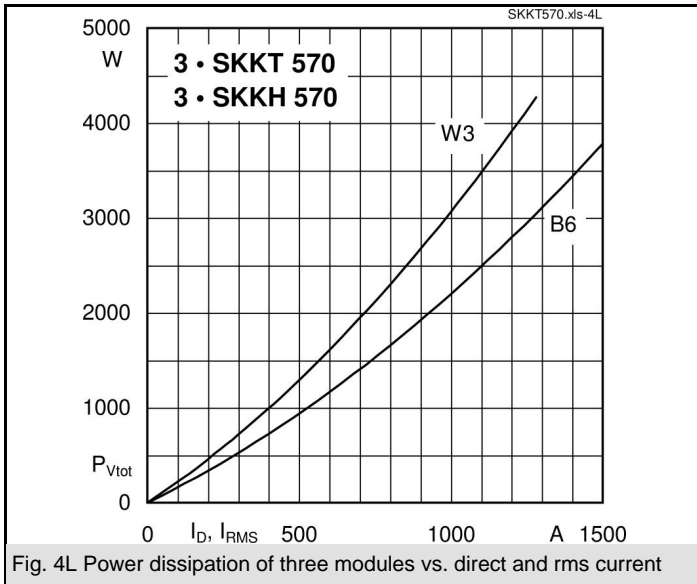

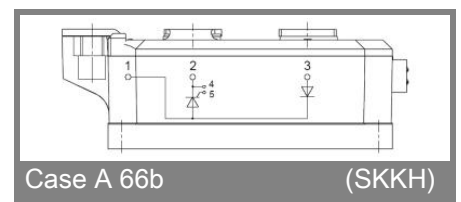
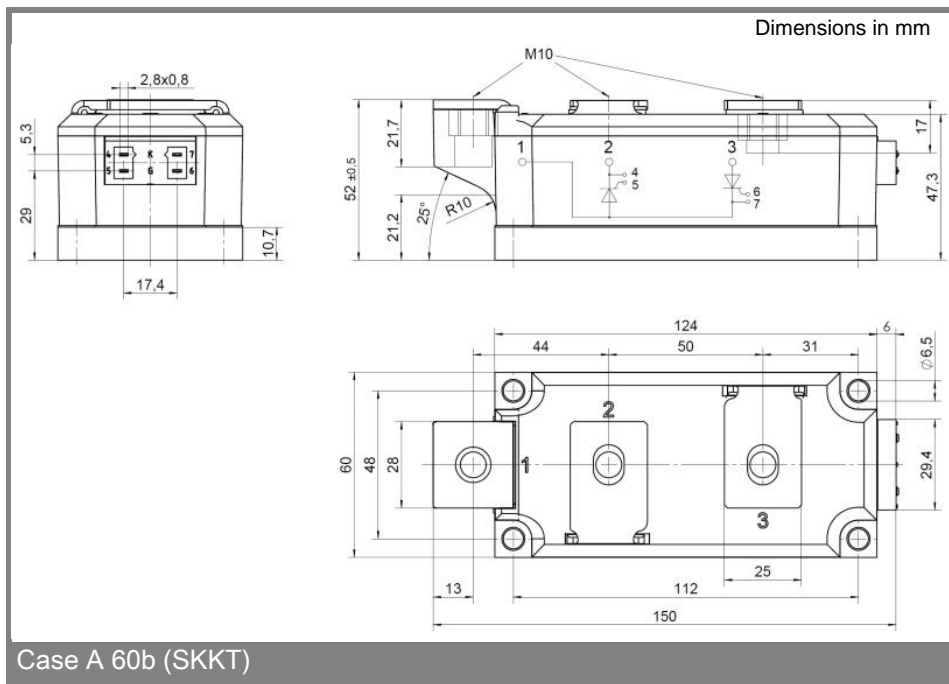
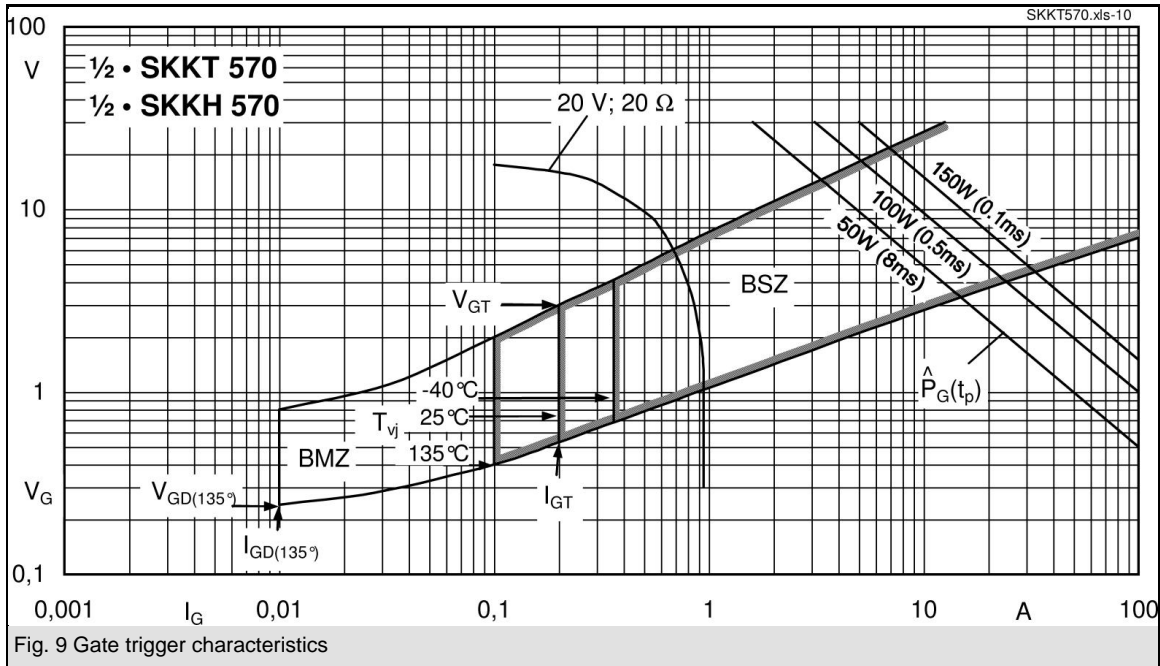

* The specifications of our components may not be considered as an assurance of component characteristics. Components have to be tested for the respective application. Adjustments may be necessary. The use of SEMIKRON products in life support appliances and systems is subject to prior specification and written approval by SEMIKRON. We therefore strongly recommend prior consultation of our personal.