

# NTC/PTC Thermistors for Automotive

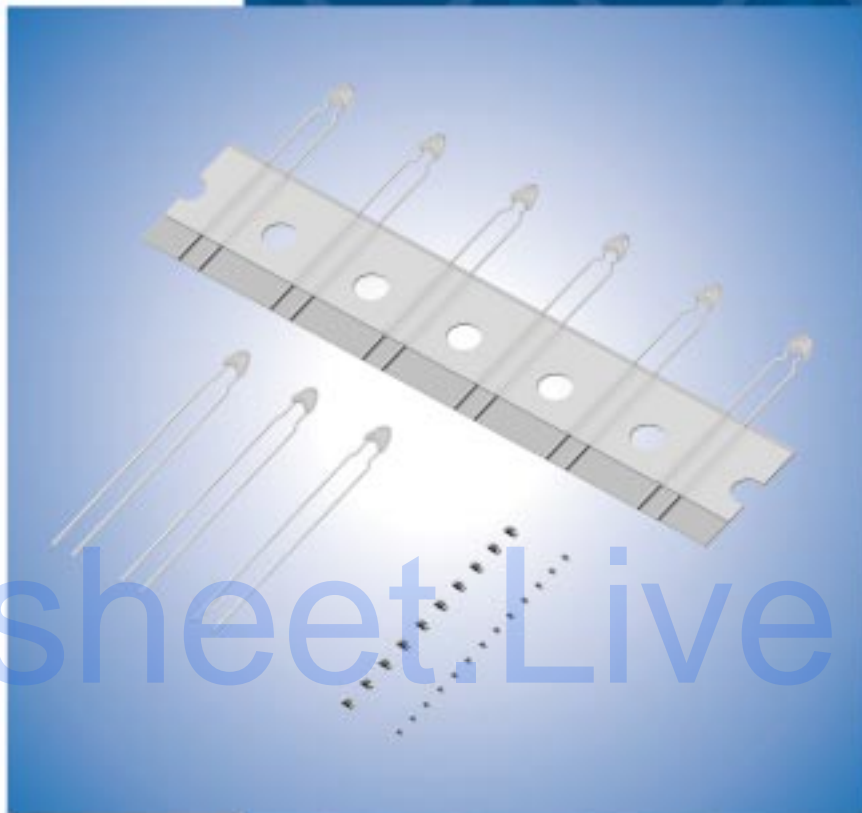

Datasheet.Live

# CONTENTS

POSISTOR® and "POSISTOR" in this catalog are the trademarks of Murata Manufacturing Co., Ltd.

<b>Part Numbering</b>	_____	2
<b>Basic Characteristics of NTC Thermistor</b>	_____	5
<b>Basic Characteristics of POSISTOR®</b>	_____	6
<b>1 NTC Thermistor Chip Type 0402 (1005) Size</b>	_____	7
<b>2 NTC Thermistor Chip Type 0603 (1608) Size</b>	_____	9
<b>3 NTC Thermistor Chip Type 0805 (2012) Size</b>	_____	11
<b>for NTC Thermistors Chip Type Temperature Characteristics (Center Value)</b>	_____	12
<b>for NTC Thermistors Chip Type Specifications and Test Methods</b>	_____	15
<b>for NTC Thermistors Chip Type ⚠Caution/Notice</b>	_____	17
<b>4 NTC Thermistor Lead Type for Temperature Sensor</b>	_____	21
● for NTC Thermistors Lead Type Temperature Characteristics (Center Value)	_____	22
● for NTC Thermistors Lead Type Specifications and Test Methods	_____	23
● for NTC Thermistors Lead Type ⚠Caution/Notice	_____	24
<b>5 PTC Thermistor (POSISTOR®) for Overheat Sensing Chip Type 0603 (1608) Size</b>	_____	25
● Chip Type of POSISTOR® for Overheat Protection Specifications and Test Methods	_____	28
<b>6 PTC Thermistor (POSISTOR®) for Overcurrent Protection Chip Type 0805 (2012) Size</b>	_____	30
● Chip Type of POSISTOR® for Overheat Protection Specifications and Test Methods	_____	32
<b>for POSISTOR® Chip Type ⚠Caution/Notice</b>	_____	34
<b>7 PTC Thermistor (POSISTOR®) for Overcurrent Protection Lead Type</b>	_____	40
● POSISTOR® Lead Type for Overheat Protection Specifications and Test Methods	_____	48
● POSISTOR® Lead Type for Overheat Protection ⚠Caution/Notice	_____	50
<b>for NTC Thermistors Chip Type Package</b>	_____	51
<b>for NTC Thermistors Lead Type Package</b>	_____	54
<b>for POSISTOR® Chip Type Package</b>	_____	55
<b>for POSISTOR® Lead Type Package</b>	_____	56

1

2

3

4

5

6

7

● Part Numbering

NTC Thermistors for Temperature Compensation Chip Type



① Product ID

Product ID	
<b>NC</b>	NTC Thermistors Chip Type

② Series

Code	Series
<b>M</b>	Soldered Termination Series
<b>P</b>	Plated Termination Series

③ Dimensions (L×W)

Code	Dimensions (L×W)	EIA
<b>15</b>	1.00×0.50mm	0402
<b>18</b>	1.60×0.80mm	0603
<b>21</b>	2.00×1.25mm	0805

④ Temperature Characteristics

Code	Temperature Characteristics
<b>WB</b>	Nominal B-Constant 4050–4099K
<b>WD</b>	Nominal B-Constant 4150–4199K
<b>WF</b>	Nominal B-Constant 4250–4299K
<b>WL</b>	Nominal B-Constant 4450–4499K
<b>WM</b>	Nominal B-Constant 4500–4549K
<b>XC</b>	Nominal B-Constant 3100–3149K
<b>XF</b>	Nominal B-Constant 3250–3299K
<b>XQ</b>	Nominal B-Constant 3650–3699K
<b>XH</b>	Nominal B-Constant 3350–3399K
<b>XM</b>	Nominal B-Constant 3500–3549K
<b>XV</b>	Nominal B-Constant 3900–3949K
<b>XW</b>	Nominal B-Constant 3950–3999K

⑤ Resistance

Expressed by three figures. The unit is ohm (Ω). The first and second figures are significant digits, and the third figure expresses the number of zeros which follow the two figures. If there is a decimal point, it is expressed by the capital letter "R". In this case, all figures are significant digits.

Ex.)

Code	Resistance
<b>102</b>	1kΩ
<b>103</b>	10kΩ
<b>104</b>	100kΩ

⑥ Resistance Tolerance

Code	Resistance Tolerance
<b>E</b>	±3%
<b>F</b>	±1%
<b>J</b>	±5%
<b>K</b>	±10%

⑦ Individual Specifications

Structures and others are expressed by two figures.

Code	Individual Specifications
<b>0S</b>	for Automotive

⑧ Packaging

Code	Packaging
<b>RB</b>	Paper Taping 4mm Pitch
<b>RC</b>	Paper Taping 2mm Pitch (10000 pcs.)

## NTC Thermistors for Temperature Sensor Lead Type

(Part Number) 

NT	SS0	XH	103	F	E1	B0
①	②	③	④	⑤	⑥	⑦

### ① Product ID

Product ID	
NT	NTC Thermistors

### ② Series

Code	Series
SS0	Temperature Sensors for Automotive Equipment

### ③ Temperature Characteristics

Code	Temperature Characteristics
WB	Nominal B-Constant 4050–4099K
WC	Nominal B-Constant 4100–4149K
WD	Nominal B-Constant 4150–4199K
WF	Nominal B-Constant 4250–4299K
XM	Nominal B-Constant 3500–3549K
XH	Nominal B-Constant 3350–3399K
XR	Nominal B-Constant 3700–3749K
XV	Nominal B-Constant 3900–3949K

### ④ Resistance

Expressed by three figures. The unit is ohm ( $\Omega$ ). The first and second figures are significant digits, and the third figure expresses the number of zeros which follow the two figures. If there is a decimal point, it is expressed by the capital letter "R". In this case, all figures are significant digits.

Ex.)

Code	Resistance
202	2k $\Omega$
203	20k $\Omega$

### ⑤ Resistance Tolerance

Code	Resistance Tolerance
E	$\pm 3\%$
F	$\pm 1\%$

### ⑥ Individual Specifications

A lead structure and other specifications are expressed by two digits.

Code	Individual Specifications
E1	Bulk
N6	Standard Taping

### ⑦ Packaging

Code	Packaging
A0	Ammo Pack
B0	Bulk

## PTC Thermistors (POSISTOR<sup>®</sup>) for Overheat Sensing Chip Type

(Part Number) 

PR	F	18	BB	471	Q	S2	RB
①	②	③	④	⑤	⑥	⑦	⑧

### ① Product ID

Product ID	
PR	PTC Thermistors Chip Type

### ② Series

Code	Series
F	for Overheat Sensing

### ③ Dimensions (L×W)

Code	Dimensions (L×W)
18	1.60×0.80mm

### ④ Temperature Characteristics

Code	Temperature Characteristics
AR	Curie Point 120°C
AS	Curie Point 130°C
BA	Curie Point 110°C
BB	Curie Point 100°C
BC	Curie Point 90°C
BD	Curie Point 80°C
BE	Curie Point 70°C
BF	Curie Point 60°C
BG	Curie Point 50°C

### ⑤ Resistance

Expressed by three figures. The unit is ohm ( $\Omega$ ). The first and second figures are significant digits, and the third figure expresses the number of zeros which follow the two figures. If there is a decimal point, it is expressed by the capital letter "R". In this case, all figures are significant digits.

Ex.)

Code	Resistance
471	470 $\Omega$

### ⑥ Resistance Tolerance

Code	Resistance Tolerance	Sensing Temp. Tolerance
Q	Special Tolerance	$\pm 5^\circ\text{C}$
R	Special Tolerance	$\pm 3^\circ\text{C}$

### ⑦ Individual Specifications

Code	Individual Specifications
S2	for Automotive

### ⑧ Packaging

Code	Packaging
RB	Paper Taping (4mm Pitch)

### PTC Thermistors (POSISTOR®) for Circuit Protection

(Part Number) 

PR	G	21	AR	420	M	S1	RA
①	②	③	④	⑤	⑥	⑦	⑧

① Product ID

Product ID	
<b>PR</b>	PTC Thermistors Chip Type

② Series

Code	Series
<b>G</b>	for Overcurrent Protection

③ Dimensions (L×W)

Code	Dimensions (L×W)
<b>21</b>	2.00×1.25mm

④ Temperature Characteristics

Code	Temperature Characteristics
<b>AR</b>	Curie Point 120°C

⑤ Resistance

Expressed by three figures. The unit is ohm (Ω). The first and second figures are significant digits, and the third figure expresses the number of zeros which follow the two figures. If there is a decimal point, it is expressed by the capital letter "R". In this case, all figures are significant digits.

Ex.)

Code	Resistance
<b>420</b>	42Ω
<b>471</b>	470Ω

⑥ Resistance Tolerance

Code	Resistance Tolerance
<b>M</b>	±20%
<b>Q</b>	Special Tolerance

⑦ Individual Specifications

Code	Individual Specifications
<b>S1</b>	for Automotive

⑧ Packaging

Code	Packaging
<b>RA</b>	Plastic Taping (4mm Pitch) (4000pcs.)
<b>RK</b>	Plastic Taping (4mm Pitch) (3000pcs.)

### PTC Thermistors (POSISTOR®) for Circuit Protection Lead Type

(Part Number) 

PT	GL	4	S	AS	220	K	4B51	B0
①	②	③	④	⑤	⑥	⑦	⑧	⑨

① Product ID

Product ID	
<b>PT</b>	PTC Thermistors

② Series

Code	Series
<b>GL</b>	for Circuit Protection Lead Type

③ Dimensions

Code	Dimensions
<b>4</b>	Nominal Body Diameter 4mm Series
<b>5</b>	Nominal Body Diameter 5mm Series
<b>7</b>	Nominal Body Diameter 7mm Series
<b>9</b>	Nominal Body Diameter 9mm Series
<b>C</b>	Nominal Body Diameter 12mm Series

④ Individual Specifications

Code	Individual Specifications
<b>S</b>	for Automotive

⑤ Temperature Characteristics

Code	Temperature Characteristics
<b>AS</b>	Curie Point 130°C

⑥ Resistance

Expressed by three figures. The unit is ohm (Ω). The first and second figures are significant digits, and the third figure expresses the number of zeros which follow the two figures. If there is a decimal point, it is expressed by the capital letter "R". In this case, all figures are significant digits.

Ex.)

Code	Resistance
<b>R22</b>	0.22Ω
<b>2R2</b>	2.2Ω
<b>220</b>	22Ω

⑦ Resistance Tolerance

Code	Resistance Tolerance
<b>K</b>	±10%

⑧ Individual Specifications

Ex.)

Code	Individual Specifications
<b>4B51</b>	Lead Type, others

⑨ Packaging

Code	Packaging
<b>A0</b>	Ammo Pack
<b>B0</b>	Bulk

# Basic Characteristics of NTC Thermistor

## ■ Basic Characteristics

### 1. Zero-power Resistance of Thermistor: R

Measured by zero-power in specified ambient temperatures.

$$R = R_0 \exp B (1/T - 1/T_0) \quad \dots\dots\dots (1)$$

R: Resistance in ambient temperature T (K)  
(K: absolute temperature)

R<sub>0</sub>: Resistance in ambient temperature T<sub>0</sub> (K)

B: B-constant of Thermistor

### 2. B-Constant

as (1) formula

$$B = \frac{\ln (R/R_0)}{(1/T - 1/T_0)} \quad \dots\dots\dots (2)$$

### 3. Thermal Dissipation Constant

When electric power P (mW) is spent in ambient temperature T<sub>1</sub> and thermistor temperature rises T<sub>2</sub>, there is a formula as follows

$$P = C (T_2 - T_1) \quad \dots\dots\dots (3)$$

C: Thermal dissipation constant (mW/°C)

Thermal dissipation constant is varied with dimensions, measurement conditions, etc.

### 4. Thermal Time Constant

Period in which Thermistor's temperature will change 63.2% of its temperature difference from ambient temperature T<sub>0</sub> (°C) to T<sub>1</sub> (°C).

### 5. Rated Electric Power

Shows necessary electric power that Thermistor's temperature rises 100°C by self heating in ambient temperature 25°C.

### 6. Permissive Operating Current

It is possible to keep Thermistor's temperature rising max. 1°C.

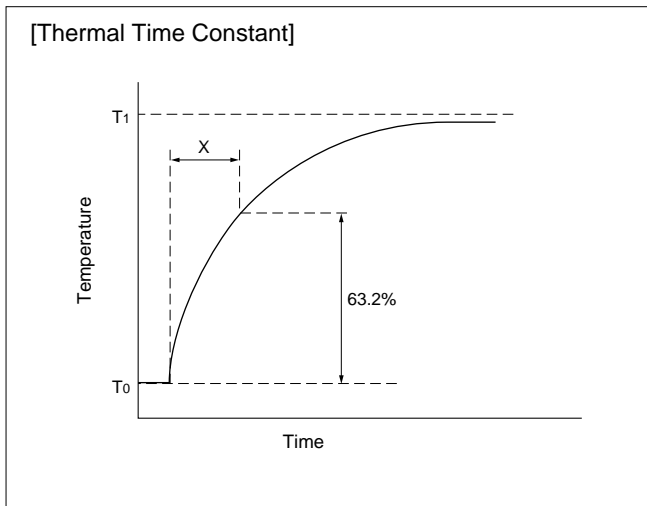
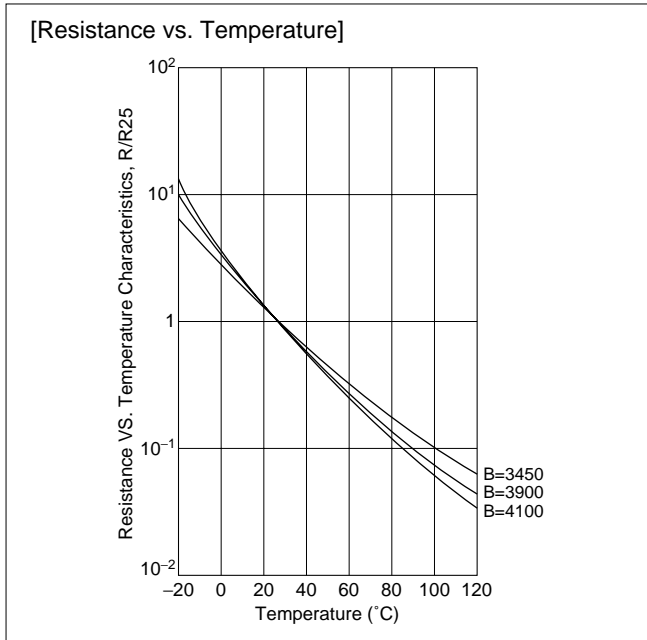

## Basic Characteristics of POSISTOR®

### Basic Characteristics

POSISTOR® has three main characteristics.

#### 1. Resistance-Temperature Characteristic

Although there is a negligible difference between the normal and "Curie-point" temperature, POSISTOR® shows almost constant resistance-temperature characteristics. Yet they have resistance-temperature characteristics that cause resistance to sharply increase when the temperature exceeds the Curie-point.

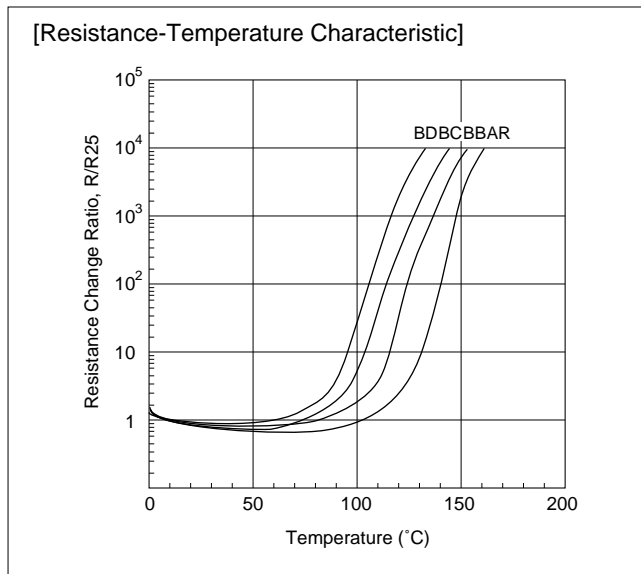

#### 2. Current-Voltage Characteristic (Static Characteristic)

This shows the relation between applied voltage when voltage applied to POSISTOR® causes balancing of inner heating and outer thermal dissipation and stabilized current. This has both a maximum point of current and constant output power.

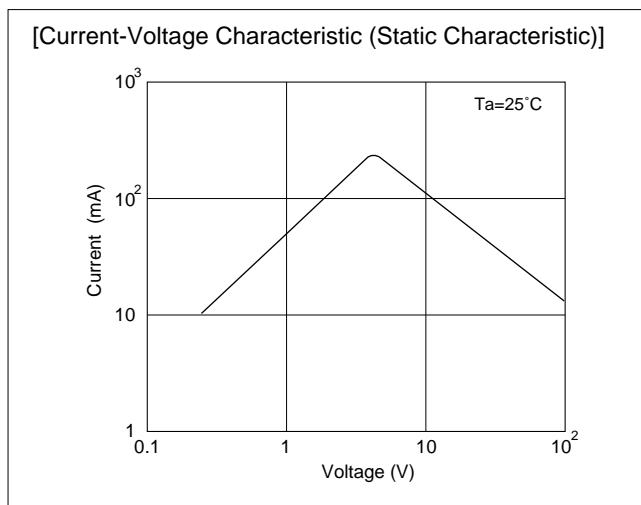

#### 3. Current-Time Characteristic (Dynamic Characteristic)

This shows the relation between current and time before inner heating and outer thermal dissipation arrive at equilibrium state. This features having large initial current and abruptly continuous attenuating portion.

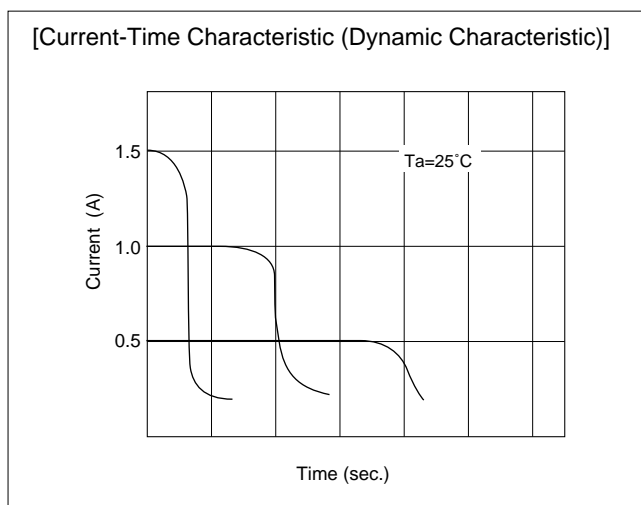

# NTC/PTC Thermistors for Automotive



## NTC Thermistor Chip Type 0402 (1005) Size

0402/0603 sized Chip NTC Thermistors have Ni barrier termination and provide excellent solderability and offer high stability in environment by unique inner construction.

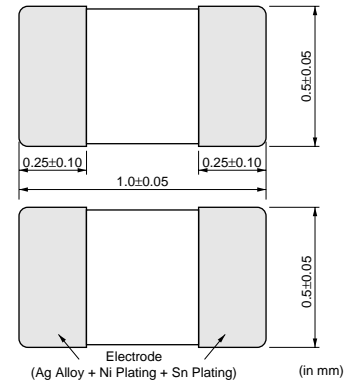
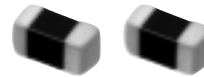

### ■ Features

1. Excellent solderability and high stability in environment
2. Excellent long time aging stability
3. High accuracy in resistance and B-constant
4. Reflow soldering possible
5. Lead is not contained in the product
6. NCP15 series are recognized by UL (UL1434, File No.E137188 Vol.2, Sec.2).

### ■ Applications

1. Car audio, car navigation
2. Various engine control units
3. Circuits for ETC equipment
4. Various motor driving circuits
5. Temperature compensation for various circuits

Part Number	Resistance (25°C)	B-Constant (25-50°C) (K)	Permissible Operating Current (25°C) (mA)	Rated Electric Power (25°C) (mW)	Typical Dissipation Constant (25°C) (mW/°C)	Operating Temperature Range (°C)
NCP15XC220□0SRC	22ohm	3100 ±3%	6.70	100	1.0	-40 to 125
NCP15XC330□0SRC	33ohm	3100 ±3%	5.50	100	1.0	-40 to 125
NCP15XC470□0SRC	47ohm	3100 ±3%	4.60	100	1.0	-40 to 125
NCP15XC680□0SRC	68ohm	3100 ±3%	3.80	100	1.0	-40 to 125
NCP15XF101□0SRC	100ohm	3250 ±3%	3.10	100	1.0	-40 to 125
NCP15XF151□0SRC	150ohm	3250 ±3%	2.50	100	1.0	-40 to 125
NCP15XM221□0SRC	220ohm	3500 ±3%	2.10	100	1.0	-40 to 125
NCP15XM331□0SRC	330ohm	3500 ±3%	1.70	100	1.0	-40 to 125
NCP15XQ471□0SRC	470ohm	3650 ±2%	1.40	100	1.0	-40 to 125
NCP15XQ681□0SRC	680ohm	3650 ±3%	1.20	100	1.0	-40 to 125
NCP15XQ102□0SRC	1.0k ohm	3650 ±2%	1.00	100	1.0	-40 to 125
NCP15XW152□0SRC	1.5k ohm	3950 ±3%	0.81	100	1.0	-40 to 125
NCP15XW222□0SRC	2.2k ohm	3950 ±3%	0.67	100	1.0	-40 to 125
NCP15XW332□0SRC	3.3k ohm	3950 ±3%	0.55	100	1.0	-40 to 125
NCP15XM472□0SRC	4.7k ohm	3500 ±2%	0.46	100	1.0	-40 to 125
NCP15XW682□0SRC	6.8k ohm	3950 ±3%	0.38	100	1.0	-40 to 125
NCP15XH103□0SRC	10k ohm	3380 ±1%	0.31	100	1.0	-40 to 125
NCP15XV103□0SRC	10k ohm	3900 ±3%	0.31	100	1.0	-40 to 125
NCP15XW153□0SRC	15k ohm	3950 ±3%	0.25	100	1.0	-40 to 125
NCP15WL223□0SRC	22k ohm	4485 ±1%	0.21	100	1.0	-40 to 125
NCP15XW223□0SRC	22k ohm	3950 ±3%	0.21	100	1.0	-40 to 125
NCP15WB333□0SRC	33k ohm	4050 ±3%	0.17	100	1.0	-40 to 125
NCP15WL333□0SRC	33k ohm	4485 ±3%	0.17	100	1.0	-40 to 125
NCP15WB473□0SRC	47k ohm	4050 ±1%	0.14	100	1.0	-40 to 125
NCP15WL473□0SRC	47k ohm	4485 ±1%	0.14	100	1.0	-40 to 125
NCP15WD683□0SRC	68k ohm	4150 ±3%	0.12	100	1.0	-40 to 125
NCP15WL683□0SRC	68k ohm	4485 ±1%	0.12	100	1.0	-40 to 125
NCP15WF104□0SRC	100k ohm	4250 ±1%	0.10	100	1.0	-40 to 125

Continued on the following page.



Continued from the preceding page.

Part Number	Resistance (25°C)	B-Constant (25-50°C) (K)	Permissible Operating Current (25°C) (mA)	Rated Electric Power (25°C) (mW)	Typical Dissipation Constant (25°C) (mW/°C)	Operating Temperature Range (°C)
<b>NCP15WL104□0SRC</b>	100k ohm	4485 ±1%	0.10	100	1.0	-40 to 125
<b>NCP15WL154□0SRC</b>	150k ohm	4485 ±1%	0.08	100	1.0	-40 to 125
<b>NCP15WM154□0SRC</b>	150k ohm	4500 ±3%	0.08	100	1.0	-40 to 125
<b>NCP15WM224□0SRC</b>	220k ohm	4500 ±3%	0.06	100	1.0	-40 to 125
<b>NCP15WM474□0SRC</b>	470k ohm	4500 ±3%	0.04	100	1.0	-40 to 125

A blank column is filled with resistance tolerance codes. (J: ±5%, K: ±10%)

Resistance tolerance ±1% is also available for the following type.

10k ohm: NCP15XH103F0SRC

47k ohm: NCP15WB473F0SRC

100k ohm: NCP15WF104F0SRC

## ■ Standard Land Pattern Dimensions

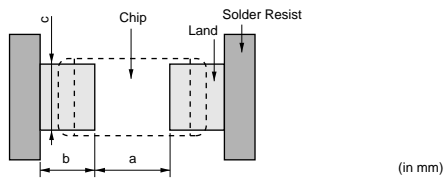

Part Number	Soldering Methods	Dimensions (mm)			
		Chip (L×W)	a	b	c
<b>NCP15</b>	Reflow Soldering	1.0×0.5	0.4	0.4-0.5	0.5
<b>NCP18</b>	Flow Soldering	1.6×0.8	0.6-1.0	0.8-0.9	0.6-0.8
	Reflow Soldering		0.6-0.8	0.6-0.7	0.6-0.8
<b>NCM21</b>	Flow Soldering	2.0×1.25	1.0-1.1	0.9-1.0	1.0-1.2
	Reflow Soldering		1.0-1.1	0.6-0.7	1.0-1.2

# NTC/PTC Thermistors for Automotive



## NTC Thermistor Chip Type 0603 (1608) Size

0402/0603 sized Chip NTC Thermistors have Ni barrier termination and provide excellent solderability and offer high stability in environment by unique inner construction.

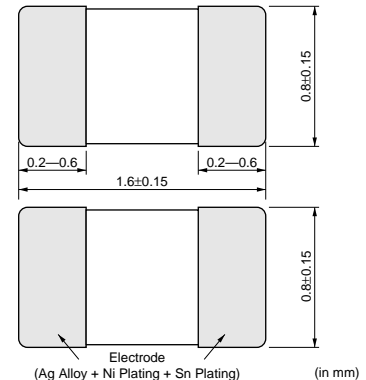

### ■ Features

1. Excellent solderability and high stability in environment
2. Excellent long time aging stability
3. High accuracy in resistance and B-constant
4. Flow/Reflow soldering possible
5. Lead is not contained in the product
6. NCP18 series are recognized by UL (UL1434, File No.E137188 Vol.2, Sec.2 ).

### ■ Applications

1. Car audio, car navigation
2. Various engine control units
3. Circuits for ETC equipment
4. Various motor driving circuits
5. Temperature compensation for various circuits

Part Number	Resistance (25°C)	B-Constant (25-50°C) (K)	Permissible Operating Current (25°C) (mA)	Rated Electric Power (25°C) (mW)	Typical Dissipation Constant (25°C) (mW/°C)	Operating Temperature Range (°C)
NCP18XF101□0SRB	100ohm	3250 ±3%	3.10	100	1.0	-40 to 125
NCP18XF151□0SRB	150ohm	3250 ±3%	2.50	100	1.0	-40 to 125
NCP18XM221□0SRB	220ohm	3500 ±3%	2.10	100	1.0	-40 to 125
NCP18XM331□0SRB	330ohm	3500 ±3%	1.70	100	1.0	-40 to 125
NCP18XQ471□0SRB	470ohm	3650 ±2%	1.40	100	1.0	-40 to 125
NCP18XQ681□0SRB	680ohm	3650 ±3%	1.20	100	1.0	-40 to 125
NCP18XQ102□0SRB	1.0k ohm	3650 ±2%	1.00	100	1.0	-40 to 125
NCP18XW152□0SRB	1.5k ohm	3950 ±3%	0.81	100	1.0	-40 to 125
NCP18XW222□0SRB	2.2k ohm	3950 ±3%	0.67	100	1.0	-40 to 125
NCP18XW332□0SRB	3.3k ohm	3950 ±3%	0.55	100	1.0	-40 to 125
NCP18XM472□0SRB	4.7k ohm	3500 ±2%	0.46	100	1.0	-40 to 125
NCP18XW682□0SRB	6.8k ohm	3950 ±3%	0.38	100	1.0	-40 to 125
NCP18XH103□0SRB	10k ohm	3380 ±1%	0.31	100	1.0	-40 to 125
NCP18XW153□0SRB	15k ohm	3950 ±3%	0.25	100	1.0	-40 to 125
NCP18XW223□0SRB	22k ohm	3950 ±3%	0.21	100	1.0	-40 to 125
NCP18WB333□0SRB	33k ohm	4050 ±3%	0.17	100	1.0	-40 to 125
NCP18WB473□0SRB	47k ohm	4050 ±2%	0.14	100	1.0	-40 to 125
NCP18WD683□0SRB	68k ohm	4150 ±3%	0.12	100	1.0	-40 to 125
NCP18WF104□0SRB	100k ohm	4250 ±2%	0.10	100	1.0	-40 to 125
NCP18WM154□0SRB	150k ohm	4500 ±3%	0.08	100	1.0	-40 to 125
NCP18WM224□0SRB	220k ohm	4500 ±3%	0.06	100	1.0	-40 to 125
NCP18WM474□0SRB	470k ohm	4500 ±3%	0.04	100	1.0	-40 to 125

A blank column is filled with resistance tolerance codes. (J: ±5%, K: ±10%)

Resistance tolerance ±1% is also available for the following type.

10k ohm: NCP18XH103F0SRB

47k ohm: NCP18WB473F1SRB

100k ohm: NCP18WF104F3SRB

## ■ Standard Land Pattern Dimensions

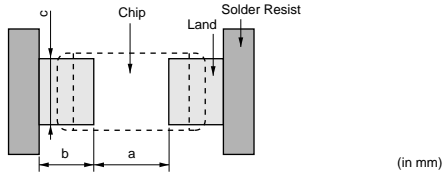

Part Number	Soldering Methods	Dimensions (mm)			
		Chip (L×W)	a	b	c
<b>NCP15</b>	Reflow Soldering	1.0×0.5	0.4	0.4-0.5	0.5
	Flow Soldering		0.6-1.0	0.8-0.9	0.6-0.8
<b>NCP18</b>	Reflow Soldering	1.6×0.8	0.6-0.8	0.6-0.7	0.6-0.8
	Flow Soldering		1.0-1.1	0.9-1.0	1.0-1.2
<b>NCM21</b>	Reflow Soldering	2.0×1.25	1.0-1.1	0.6-0.7	1.0-1.2

2

# NTC/PTC Thermistors for Automotive



## NTC Thermistor Chip Type 0805 (2012) Size

0805 sized Chip NTC Thermistors have Ni barrier termination and offer high stability in environment by unique inner construction.

### ■ Features

1. High climate performance unique manufacturing method
2. Excellent long time aging stability
3. The performance of this product meets to AEC-Q200 (Automotive Electronics Council)
4. Lead is not contained in the product
5. High accuracy in resistance and B-constant
6. Flow/Reflow soldering possible

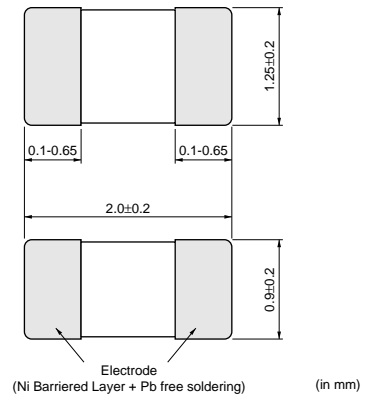

### ■ Applications

1. Car audio, car navigation
2. Various engine control units
3. Circuits for ETC equipment
4. Various motor driving circuits
5. Temperature compensation for various circuits

Part Number	Resistance (25°C) (k ohm)	B-Constant (25-50°C) (K)	Permissible Operating Current (25°C) (mA)	Rated Electric Power (25°C) (mW)	Typical Dissipation Constant (25°C) (mW/°C)	Operating Temperature Range (°C)
<b>NCM21XQ103□0SRA</b>	10	3650 ±3%	0.44	200	2.0	-40 to 125
<b>NCM21XW223□0SRA</b>	22	3950 ±3%	0.30	200	2.0	-40 to 125
<b>NCM21WB473□0SRA</b>	47	4050 ±3%	0.20	200	2.0	-40 to 125
<b>NCM21WF104□0SRA</b>	100	4250 ±3%	0.14	200	2.0	-40 to 125

A blank column is filled with resistance tolerance codes. (J: ±5%, K: ±10%)

### ■ Standard Land Pattern Dimensions

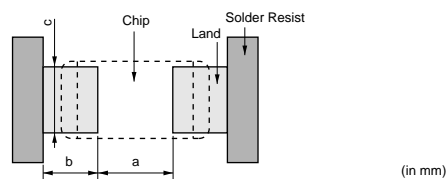

Part Number	Soldering Methods	Dimensions (mm)			
		Chip (L×W)	a	b	c
<b>NCP15</b>	Reflow Soldering	1.0×0.5	0.4	0.4-0.5	0.5
	Flow Soldering	1.6×0.8	0.6-1.0	0.8-0.9	0.6-0.8
Reflow Soldering	0.6-0.8		0.6-0.7	0.6-0.8	
<b>NCM21</b>	Flow Soldering	2.0×1.25	1.0-1.1	0.9-1.0	1.0-1.2
	Reflow Soldering		1.0-1.1	0.6-0.7	1.0-1.2

## for NTC Thermistors Chip Type Temperature Characteristics (Center Value)

Part Number	NCP□□XC220	NCP□□XC330	NCP□□XC470	NCP□□XC680	NCP□□XF101	NCP□□XF151	NCP□□XM221	NCP□□XM331
Resistance	22Ω	33Ω	47Ω	68Ω	100Ω	150Ω	220Ω	330Ω
B-Constant	3100K	3100K	3100K	3100K	3250K	3250K	3500K	3500K
Temp. (°C)	Resistance (Ω)	Resistance (Ω)	Resistance (Ω)	Resistance (Ω)	Resistance (Ω)	Resistance (Ω)	Resistance (Ω)	Resistance (Ω)
-40	355.823	533.734	760.166	1099.815	1824.175	2736.262	4947.904	7421.856
-35	273.975	410.962	585.310	846.832	1390.685	2086.028	3703.755	5555.632
-30	213.003	319.504	455.051	658.372	1070.653	1605.979	2798.873	4198.309
-25	166.943	250.415	356.652	516.007	831.138	1246.708	2135.887	3203.831
-20	131.997	197.996	281.994	407.991	650.960	976.440	1645.037	2467.555
-15	105.318	157.978	224.998	325.529	514.441	771.661	1278.034	1917.051
-10	84.670	127.005	180.886	261.707	409.700	614.550	1000.620	1500.930
-5	68.628	102.942	146.614	212.123	328.877	493.315	789.612	1184.418
0	55.981	83.972	119.596	173.033	265.759	398.639	627.752	941.628
5	45.859	68.789	97.972	141.747	215.785	323.677	502.474	753.711
10	37.819	56.728	80.794	116.894	176.395	264.592	405.010	607.514
15	31.396	47.094	67.073	97.042	145.161	217.742	328.480	492.720
20	26.211	39.317	55.997	81.016	120.152	180.228	268.044	402.066
25	22.000	33.000	47.000	68.000	100.000	150.000	220.000	330.000
30	18.560	27.840	39.651	57.368	83.669	125.503	181.576	272.365
35	15.735	23.603	33.616	48.636	70.361	105.541	150.668	226.002
40	13.403	20.104	28.633	41.426	59.456	89.184	125.681	188.521
45	11.462	17.193	24.487	35.428	50.470	75.705	105.336	158.004
50	9.842	14.763	21.026	30.421	43.029	64.543	88.717	133.076
55	8.488	12.732	18.133	26.235	36.830	55.246	75.059	112.588
60	7.348	11.022	15.698	22.712	31.649	47.473	63.777	95.666
65	6.399	9.598	13.670	19.778	27.364	41.045	54.415	81.622
70	5.595	8.392	11.952	17.293	23.756	35.634	46.631	69.946
75	4.896	7.345	10.461	15.134	20.651	30.976	40.115	60.172
80	4.299	6.448	9.184	13.288	18.011	27.016	34.637	51.955
85	3.795	5.692	8.107	11.729	15.800	23.700	30.013	45.019
90	3.360	5.040	7.179	10.386	13.908	20.862	26.110	39.165
95	2.983	4.474	6.373	9.220	12.263	18.394	22.790	34.186
100	2.656	3.983	5.673	8.208	10.844	16.265	19.957	29.935
105	2.367	3.551	5.057	7.317	9.622	14.434	17.541	26.312
110	2.116	3.173	4.520	6.539	8.563	12.844	15.453	23.180
115	1.901	2.851	4.060	5.874	7.648	11.472	13.663	20.494
120	1.712	2.568	3.657	5.291	6.850	10.275	12.114	18.171
125	1.543	2.314	3.296	4.768	6.162	9.243	10.778	16.168

Part Number	NCP□□XQ471	NCP□□XQ681	NCP□□XQ102	NCP□□XW152	NCP□□XW222	NCP□□XW332	NCP□□XM472	NCP□□XW682
Resistance	470Ω	680Ω	1.0kΩ	1.5kΩ	2.2kΩ	3.3kΩ	4.7kΩ	6.8kΩ
B-Constant	3650K	3650K	3650K	3950K	3950K	3950K	3500K	3950K
Temp. (°C)	Resistance (Ω)	Resistance (Ω)	Resistance (kΩ)	Resistance (kΩ)	Resistance (kΩ)	Resistance (kΩ)	Resistance (kΩ)	Resistance (kΩ)
-40	11822.473	17104.854	25.154	51.791	75.961	113.941	105.705	234.787
-35	8767.745	12685.248	18.655	37.172	54.520	81.779	79.126	168.515
-30	6570.224	9505.855	13.979	27.005	39.607	59.411	59.794	122.422
-25	4971.784	7193.219	10.578	19.843	29.103	43.654	45.630	89.953
-20	3796.933	5493.436	8.079	14.728	21.601	32.401	35.144	66.766
-15	2923.400	4229.599	6.220	11.044	16.198	24.297	27.303	50.066
-10	2269.599	3283.675	4.829	8.362	12.264	18.396	21.377	37.906
-5	1775.225	2568.411	3.777	6.389	9.370	14.055	16.869	28.963
0	1399.050	2024.158	2.977	4.922	7.219	10.829	13.411	22.313
5	1110.220	1606.275	2.362	3.825	5.609	8.414	10.735	17.338
10	887.257	1283.691	1.888	2.994	4.391	6.586	8.653	13.571
15	713.463	1032.245	1.518	2.361	3.463	5.195	7.018	10.705
20	577.375	835.351	1.229	1.876	2.751	4.126	5.726	8.503
25	470.000	680.000	1.000	1.500	2.200	3.300	4.700	6.800
30	384.800	556.733	0.819	1.207	1.771	2.656	3.879	5.474
35	316.757	458.287	0.674	0.978	1.434	2.152	3.219	4.434
40	262.177	379.320	0.558	0.797	1.169	1.753	2.685	3.613
45	218.069	315.504	0.464	0.653	0.958	1.437	2.250	2.961
50	182.297	263.749	0.388	0.538	0.789	1.184	1.895	2.440
55	153.150	221.579	0.326	0.446	0.654	0.981	1.604	2.022
60	129.249	186.998	0.275	0.371	0.545	0.817	1.363	1.683
65	109.551	158.499	0.233	0.311	0.456	0.684	1.163	1.409
70	93.281	134.960	0.199	0.261	0.383	0.575	0.996	1.185
75	79.750	115.383	0.170	0.221	0.324	0.486	0.857	1.001
80	68.446	99.029	0.146	0.187	0.275	0.412	0.740	0.849
85	58.996	85.356	0.126	0.160	0.234	0.351	0.641	0.724
90	51.036	73.839	0.109	0.137	0.200	0.301	0.558	0.620
95	44.332	64.140	0.094	0.117	0.172	0.258	0.487	0.532
100	38.640	55.905	0.082	0.101	0.149	0.223	0.426	0.459
105	33.790	48.888	0.072	0.088	0.129	0.193	0.375	0.398
110	29.664	42.918	0.063	0.076	0.112	0.168	0.330	0.346
115	26.123	37.795	0.056	0.067	0.098	0.146	0.292	0.302
120	23.091	33.409	0.049	0.058	0.085	0.128	0.259	0.264
125	20.472	29.618	0.044	0.051	0.075	0.113	0.230	0.232

Continued on the following page. ↗

## for NTC Thermistors Chip Type Temperature Characteristics (Center Value)

Continued from the preceding page.

Part Number	NCP□□XH103	NCP□□XV103	NCM□□XQ103	NCP□□XW153	NCP□□XW223	NCM□□XW223	NCP□□WL223	NCP□□WB333
Resistance	10kΩ	10kΩ	10kΩ	15kΩ	22kΩ	22kΩ	22kΩ	33kΩ
B-Constant	3380K	3900K	3650K	3950K	3950K	3950K	4485K	4050K
Temp. (°C)	Resistance (kΩ)	Resistance (kΩ)	Resistance (kΩ)	Resistance (kΩ)	Resistance (kΩ)	Resistance (kΩ)	Resistance (kΩ)	Resistance (kΩ)
-40	195.652	328.996	251.542	517.912	759.605	759.605	1073.436	1227.263
-35	148.171	237.387	186.548	371.724	545.196	545.196	753.900	874.449
-30	113.347	173.185	139.792	270.048	396.070	396.070	535.073	630.851
-25	87.559	127.773	105.783	198.426	291.025	291.025	383.590	460.457
-20	68.237	95.327	80.786	147.278	216.008	216.008	277.643	339.797
-15	53.650	71.746	62.200	110.439	161.977	161.977	202.813	253.363
-10	42.506	54.564	48.289	83.617	122.638	122.638	149.462	190.766
-5	33.892	41.813	37.771	63.888	93.702	93.702	111.082	144.964
0	27.219	32.330	29.767	49.221	72.191	72.191	83.233	111.087
5	22.021	25.194	23.622	38.245	56.093	56.093	62.858	85.842
10	17.926	19.785	18.878	29.936	43.907	43.907	47.831	66.861
15	14.674	15.651	15.180	23.613	34.633	34.633	36.664	52.470
20	12.081	12.468	12.285	18.756	27.509	27.509	28.304	41.471
25	10.000	10.000	10.000	15.000	22.000	22.000	22.000	33.000
30	8.315	8.072	8.187	12.074	17.709	17.709	17.214	26.430
35	6.948	6.556	6.740	9.780	14.344	14.344	13.557	21.298
40	5.834	5.356	5.578	7.969	11.688	11.688	10.744	17.266
45	4.917	4.401	4.640	6.531	9.578	9.578	8.566	14.076
50	4.161	3.635	3.879	5.382	7.894	7.894	6.871	11.538
55	3.535	3.019	3.259	4.459	6.540	6.540	5.543	9.506
60	3.014	2.521	2.750	3.713	5.446	5.446	4.497	7.870
65	2.586	2.115	2.331	3.108	4.559	4.559	3.669	6.549
70	2.228	1.781	1.985	2.613	3.832	3.832	3.009	5.475
75	1.925	1.509	1.697	2.208	3.239	3.239	2.481	4.595
80	1.669	1.284	1.456	1.873	2.748	2.748	2.056	3.874
85	1.452	1.097	1.255	1.597	2.342	2.342	1.713	3.282
90	1.268	0.941	1.086	1.367	2.004	2.004	1.434	2.789
95	1.110	0.810	0.943	1.174	1.722	1.722	1.206	2.379
100	0.974	0.701	0.822	1.013	1.486	1.486	1.019	2.038
105	0.858	0.608	0.719	0.878	1.287	1.287	0.866	1.751
110	0.758	0.530	0.631	0.763	1.119	1.119	0.739	1.509
115	0.672	0.463	0.556	0.665	0.975	0.975	0.633	1.306
120	0.596	0.406	0.491	0.582	0.854	0.854	0.545	1.134
125	0.531	0.358	0.436	0.511	0.750	0.750	0.471	0.987

Part Number	NCP□□WL333	NCP□□WB473	NCM□□WB473	NCP□□WL473	NCP□□WD683	NCP□□WL683	NCP□□WF104	NCM□□WF104
Resistance	33kΩ	47kΩ	47kΩ	47kΩ	68kΩ	68kΩ	100kΩ	100kΩ
B-Constant	4485K	4050K	4050K	4485K	4150K	4485K	4250K *	4250K *
Temp. (°C)	Resistance (kΩ)	Resistance (kΩ)	Resistance (kΩ)	Resistance (kΩ)	Resistance (kΩ)	Resistance (kΩ)	Resistance (kΩ)	Resistance (kΩ)
-40	1610.154	1747.920	1747.920	2293.249	2735.359	3317.893	4397.119	4397.119
-35	1130.850	1245.428	1245.428	1610.605	1937.391	2330.237	3088.599	3088.599
-30	802.609	898.485	898.485	1143.110	1389.345	1653.862	2197.225	2197.225
-25	575.385	655.802	655.802	819.487	1008.014	1185.641	1581.881	1581.881
-20	416.464	483.954	483.954	593.146	738.978	858.168	1151.037	1151.037
-15	304.219	360.850	360.850	433.281	547.456	626.875	846.579	846.579
-10	224.193	271.697	271.697	319.305	409.600	461.974	628.988	628.988
-5	166.623	206.463	206.463	237.312	309.217	343.345	471.632	471.632
0	124.850	158.214	158.214	177.816	235.606	257.266	357.012	357.012
5	94.287	122.259	122.259	134.287	180.980	194.287	272.500	272.500
10	71.747	95.227	95.227	102.184	140.139	147.841	209.710	209.710
15	54.996	74.730	74.730	78.327	109.344	113.325	162.651	162.651
20	42.455	59.065	59.065	60.467	85.929	87.484	127.080	127.080
25	33.000	47.000	47.000	47.000	68.000	68.000	100.000	100.000
30	25.822	37.643	37.643	36.776	54.167	53.208	79.222	79.222
35	20.335	30.334	30.334	28.962	43.421	41.903	63.167	63.167
40	16.115	24.591	24.591	22.952	35.016	33.208	50.677	50.677
45	12.849	20.048	20.048	18.301	28.406	26.477	40.904	40.904
50	10.306	16.433	16.433	14.679	23.166	21.237	33.195	33.195
55	8.314	13.539	13.539	11.842	18.997	17.133	27.091	27.091
60	6.746	11.209	11.209	9.607	15.657	13.900	22.224	22.224
65	5.503	9.328	9.328	7.837	12.967	11.339	18.323	18.323
70	4.513	7.798	7.798	6.428	10.794	9.300	15.184	15.184
75	3.721	6.544	6.544	5.300	9.021	7.668	12.635	12.635
80	3.084	5.518	5.518	4.393	7.575	6.356	10.566	10.566
85	2.569	4.674	4.674	3.659	6.387	5.294	8.873	8.873
90	2.151	3.972	3.972	3.063	5.407	4.432	7.481	7.481
95	1.809	3.388	3.388	2.577	4.598	3.728	6.337	6.337
100	1.529	2.902	2.902	2.178	3.922	3.151	5.384	5.384
105	1.299	2.494	2.494	1.849	3.359	2.676	4.594	4.594
110	1.108	2.150	2.150	1.578	2.887	2.283	3.934	3.934
115	0.949	1.860	1.860	1.352	2.489	1.956	3.380	3.380
120	0.817	1.615	1.615	1.164	2.155	1.684	2.916	2.916
125	0.707	1.406	1.406	1.006	1.870	1.456	2.522	2.522

\* B-Constant of NCP18WF104F1SRB is 4200K. Please contact us for the detail data.

## for NTC Thermistors Chip Type Temperature Characteristics (Center Value)

Continued from the preceding page.

Part Number	NCP□□WL104	NCP□□WL154	NCP□□WM154	NCP□□WM224	NCP□□WM474
Resistance	100kΩ	150kΩ	150kΩ	220kΩ	470kΩ
B-Constant	4485K	4485K	4500K	4485K	4500K
Temp. (°C)	Resistance (kΩ)	Resistance (kΩ)	Resistance (kΩ)	Resistance (kΩ)	Resistance (kΩ)
-40	4879.254	7318.881	7899.466	11585.884	24751.661
-35	3426.818	5140.228	5466.118	8016.973	17127.169
-30	2432.149	3648.224	3834.499	5623.931	12014.762
-25	1743.590	2615.385	2720.523	3990.100	8524.305
-20	1262.012	1893.018	1951.216	2861.784	6113.811
-15	921.875	1382.813	1415.565	2076.162	4435.437
-10	679.373	1019.059	1036.984	1520.909	3249.216
-5	504.919	757.379	767.079	1125.049	2403.515
0	378.333	567.499	572.667	839.912	1794.358
5	285.717	428.575	431.264	632.521	1351.294
10	217.414	326.121	327.405	480.194	1025.870
15	166.654	249.981	250.538	367.455	785.018
20	128.653	192.979	193.166	283.310	605.252
25	100.000	150.000	150.000	220.000	470.000
30	78.247	117.370	117.281	172.012	367.480
35	61.622	92.433	92.293	135.364	289.186
40	48.835	73.252	73.090	107.198	229.014
45	38.937	58.406	58.240	85.419	182.485
50	31.231	46.846	46.665	68.441	146.215
55	25.195	37.793	37.605	55.153	117.828
60	20.441	30.661	30.453	44.665	95.420
65	16.675	25.013	24.804	36.379	77.718
70	13.677	20.516	20.293	29.763	63.584
75	11.277	16.916	16.679	24.462	52.260
80	9.346	14.019	13.776	20.205	43.166
85	7.785	11.678	11.428	16.761	35.808
90	6.517	9.776	9.520	13.962	29.828
95	5.482	8.223	7.966	11.684	24.961
100	4.634	6.951	6.688	9.809	20.955
105	3.935	5.902	5.639	8.270	17.668
110	3.357	5.035	4.772	6.998	14.951
115	2.877	4.315	4.052	5.942	12.695
120	2.476	3.714	3.454	5.067	10.824
125	2.141	3.211	2.955	4.334	9.259

## for NTC Thermistors Chip Type Specifications and Test Methods

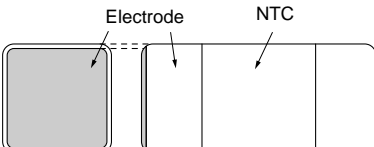
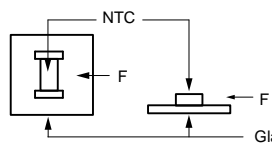
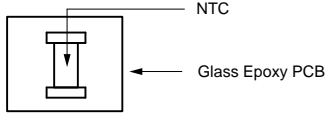
No.	Item	Rating Value	Method of Examination									
1	Dry Heat 1	<ul style="list-style-type: none"> <li>Resistance (R25) change should be less than <math>\pm 10\%</math></li> <li>B-constant (B25/50) change should be less than <math>\pm 2\%</math></li> <li>No visible damage</li> </ul>	150 $\pm$ 3°C in air, for 500 +48/-0 hrs. without loading									
2	Dry Heat 2	<ul style="list-style-type: none"> <li>Resistance (R25) change should be less than <math>\pm 5\%</math></li> <li>B-constant (B25/50) change should be less than <math>\pm 2\%</math></li> <li>No visible damage</li> </ul>	125 $\pm$ 3°C in air, for 1000 +48/-0 hrs. without loading									
3	Cold		-40 $\pm$ 3°C in air, for 1000 +48/-0 hrs. without loading									
4	Damp Heat		60 $\pm$ 2°C, 90-95%RH in air, for 1000 +48/-0 hrs. without loading									
5	High Temperature Load		85 $\pm$ 2°C in air, with Permissive Operating Current for 1000 +48/-0 hrs.									
6	Thermal Shock	<ul style="list-style-type: none"> <li>Resistance (R25) change should be less than <math>\pm 10\%</math></li> <li>B-constant (B25/50) change should be less than <math>\pm 2\%</math></li> <li>No visible damage</li> </ul>	1000 cycles of following sequence <table border="1"> <thead> <tr> <th>Step</th> <th>Temp. (°C)</th> <th>Time (min.)</th> </tr> </thead> <tbody> <tr> <td>1</td> <td>-55 +0/-3</td> <td>30</td> </tr> <tr> <td>2</td> <td>+125 +3/-0</td> <td>30</td> </tr> </tbody> </table>	Step	Temp. (°C)	Time (min.)	1	-55 +0/-3	30	2	+125 +3/-0	30
Step	Temp. (°C)	Time (min.)										
1	-55 +0/-3	30										
2	+125 +3/-0	30										
7	High Temperature Humidity Load		85 $\pm$ 2°C, 85%RH in air, with Permissive Operating Current for 1000 +48/-0 hrs.									
8	Solderability	<table border="1"> <thead> <tr> <th>P/N</th> <th>Rating value</th> </tr> </thead> <tbody> <tr> <td>NCP15</td> <td rowspan="2">Minimum 95% of the whole electrode surface should be covered with solder.</td> </tr> <tr> <td>NCP18</td> </tr> <tr> <td>NCM21</td> <td>Minimum 75% of the whole electrode surface should be covered with solder.</td> </tr> </tbody> </table>	P/N	Rating value	NCP15	Minimum 95% of the whole electrode surface should be covered with solder.	NCP18	NCM21	Minimum 75% of the whole electrode surface should be covered with solder.	Soldering Temp.: 235 $\pm$ 5°C Solder: Sn60%/Pb40% Immersion Time: 2 $\pm$ 0.5 sec. NTC Thermistor should be immersed completely under the solder meniscus		
P/N	Rating value											
NCP15	Minimum 95% of the whole electrode surface should be covered with solder.											
NCP18												
NCM21	Minimum 75% of the whole electrode surface should be covered with solder.											
9	Soldering Heat Resistant	<ul style="list-style-type: none"> <li>Resistance (R25) change should be less than <math>\pm 5\%</math></li> <li>B-constant (B25/50) change should be less than <math>\pm 2\%</math></li> <li>No visible damage</li> <li>Normal appearance on the section showed by slanting line parts of the electrodes on the figure.</li> </ul> 	Soldering Temp.: 260 $\pm$ 5°C Solder: Sn60%/Pb40% Immersion Time: 10 $\pm$ 0.5 sec. NTC Thermistor should be immersed completely under the solder meniscus. Preheating Temp.: 150 $\pm$ 5°C Preheating Time: 3 min.									
10	Robustness of Electrode	No peeling of the electrodes	Solder NTC Thermistor on the Glass Epoxy PCB, and apply force as shown below: <table border="1" style="float: right;"> <thead> <tr> <th>P/N</th> <th>Force (F)</th> </tr> </thead> <tbody> <tr> <td>NCP15</td> <td>3.0N</td> </tr> <tr> <td>NCP18</td> <td>4.90N</td> </tr> <tr> <td>NCM21</td> <td>4.90N</td> </tr> </tbody> </table> 	P/N	Force (F)	NCP15	3.0N	NCP18	4.90N	NCM21	4.90N	
P/N	Force (F)											
NCP15	3.0N											
NCP18	4.90N											
NCM21	4.90N											
11	Vibration Resistant	<ul style="list-style-type: none"> <li>Resistance (R25) change should be less than <math>\pm 5\%</math></li> <li>B-constant (B25/50) change should be less than <math>\pm 2\%</math></li> <li>No visible damage</li> </ul>	Solder NTC Thermistor on the Glass Epoxy PCB as shown below. Frequency: 10-2000-10Hz (20 min.) Max. amplitude: 3.0mm Vibrated for a period of 4 hrs. in three (3) directions perpendicularly intersecting each other (for total of 12 hrs.). 									

Continued on the following page.



## for NTC Thermistors Chip Type Specifications and Test Methods

Continued from the preceding page.

No.	Item	Rating Value	Method of Examination												
12	Resistance to Bending of Substance	<ul style="list-style-type: none"> <li>Resistance (R25) change should be less than <math>\pm 5\%</math></li> <li>B-constant (B25/50) change should be less than <math>\pm 2\%</math></li> <li>No visible damage</li> </ul>	<p>Solder NTC Thermistor on Test Board, and apply force on back side of Test Board as shown below:                      Bending Speed: 1.0mm/s, Hold Time : 5+/-1 sec.                      Board Material: Glass Epoxy</p> <table border="1"> <thead> <tr> <th>P/N</th> <th>Bending Strength (mm)</th> <th>Board Dimension (mm)</th> </tr> </thead> <tbody> <tr> <td>NCP15</td> <td>1.5</td> <td>100X40X0.8t</td> </tr> <tr> <td>NCP18</td> <td>1.5</td> <td>100X40X1.6t</td> </tr> <tr> <td>NCM21</td> <td>2.0</td> <td>100X40X1.6t</td> </tr> </tbody> </table>	P/N	Bending Strength (mm)	Board Dimension (mm)	NCP15	1.5	100X40X0.8t	NCP18	1.5	100X40X1.6t	NCM21	2.0	100X40X1.6t
P/N	Bending Strength (mm)	Board Dimension (mm)													
NCP15	1.5	100X40X0.8t													
NCP18	1.5	100X40X1.6t													
NCM21	2.0	100X40X1.6t													

- NTC Thermistor shall be soldered on the glass epoxy PCB as shown below
  - Recommendable Land Dimensions
  - Recommendable Soldering Conditions
  - Recommendable Solder paste
- R25 means the zero-power resistance at 25°C.
- B25/50 is calculated by the zero-power resistances of NTC Thermistor at 25°C and at 50°C.
- After each test, NTC Thermistor should be kept for 1 hour at room temperature (normal humidity and normal atmospheric pressure). Then the resistances (R25 and R50) should be measured and the appearance should be visually examined.
- We are not to guarantee the Resistance (R25) change and B-constant (B25/50) change in Thermal Shock (No. 6) in case of defect of part for mounting.

## for NTC Thermistors Chip Type ⚠Caution/Notice

### ■ ⚠Caution (Storage and Operating Condition)

This product is designed for application in an ordinary environment (normal room temperature, humidity and atmospheric pressure).

Do not use under the following conditions because all these factors can deteriorate the product characteristics or cause failures and burn-out.

1. Corrosive gas or deoxidizing gas  
(Chlorine gas, Hydrogen sulfide gas, Ammonia gas, Sulfuric acid gas, Nitric oxide gas, etc.)

2. Volatile or flammable gas
3. Dusty conditions
4. Under vacuum, or under high or low-pressure
5. Wet or humid locations
6. Places with salt water, oils, chemical liquids or organic solvents
7. Strong vibrations
8. Other places where similar hazardous conditions exist

### ■ ⚠Caution (Other)

Be sure to provide an appropriate fail-safe function on your product to prevent secondary damages that may be caused by the abnormal function or the failure of our product.

### ■ Notice (Storage and Operating Condition)

To keep solderability of product from declining, the following storage condition is recommended.

1. Storage condition:  
Temperature -10 to +40 degree C  
Humidity less than 75%RH (not dewing condition)
2. Storage term:  
Use this product within 6 months after delivery by first-in and first-out stocking system.

3. Handling after unpacking:  
After unpacking, reseal product promptly or store it in a sealed container with a drying agent.
4. Storage place:  
Do not store this product in corrosive gas (sulfuric acid gas, chlorine gas, etc.) or in direct sunlight.

### ■ Notice (Rating)

Use this product within the specified temperature range.

Higher temperature may cause deterioration of the characteristics or the material quality of this product.

## for NTC Thermistors Chip Type ⚠️ Caution/Notice

### ■ Notice (Soldering and Mounting)

#### 1. Mounting Position

Choose a mounting position that minimizes the stress imposed on the chip during flexing or bending of the board.

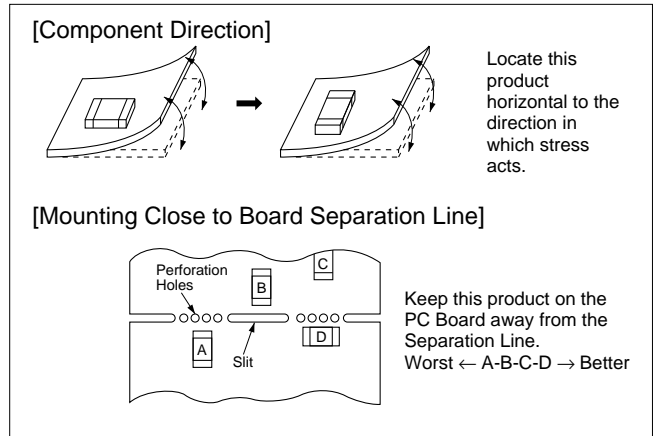

#### 2. Reflow Soldering Conditions

Allowable Reflow Soldering Temperature and Time

##### (NCP15 Series)

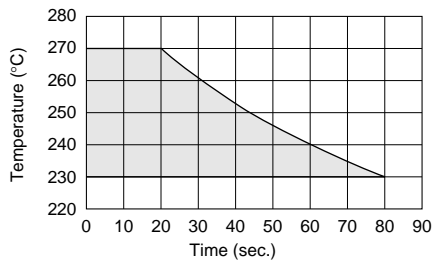

Standard Soldering Conditions

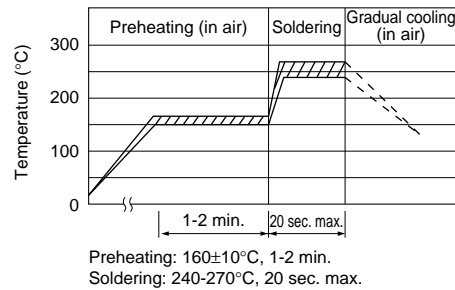

##### (NCP18 Series)

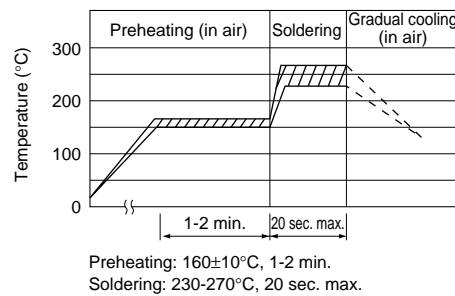
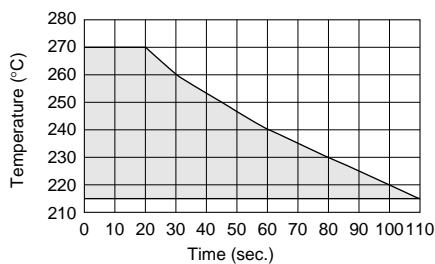

##### (NCM21 Series)

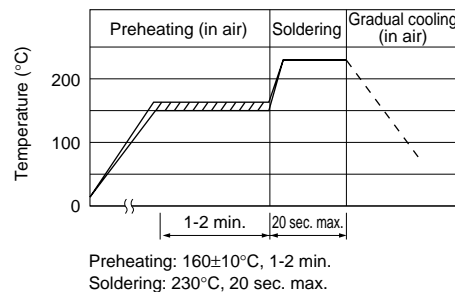
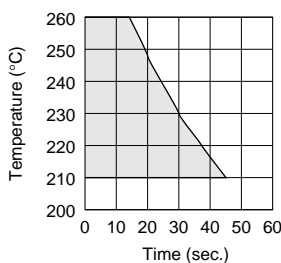

Continued on the following page. ↗

## for NTC Thermistors Chip Type ⚠Caution/Notice

☐ Continued from the preceding page.

### 3. Flow Soldering Conditions

#### Allowable Reflow Soldering Temperature and Time

##### (NCP18 Series)

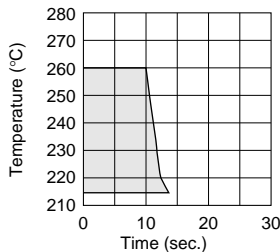

##### (NCM21 Series)

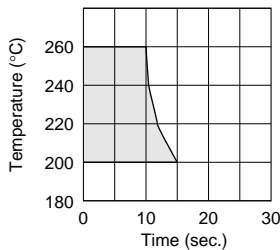

#### Standard Soldering Conditions

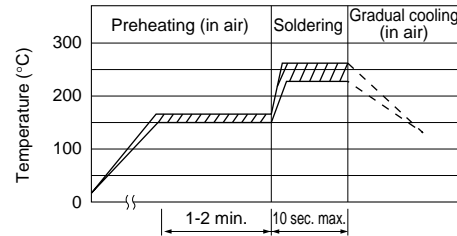

Preheating: 160±10°C, 1-2 min.  
Soldering: 230-260°C, 10 sec. max.

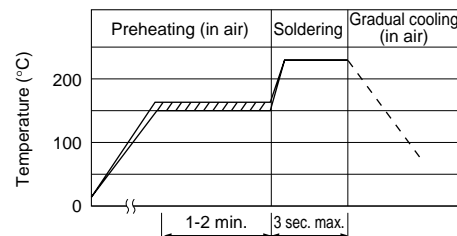

Preheating: 160±10°C, 1-2 min.  
Soldering: 240°C, 3 sec. max.

### 4. Solder and Flux

#### (1) Solder and Paste

- (a) Reflow Soldering: NCP15/NCP18/NCM21 Series  
Use RA/RMA type or equivalent type of solder paste.  
For your reference, we are using the solder paste below for any internal tests of this product.
- RMA9086 90-4-M20 (Sn:Pb=63wt%:37wt%)  
(Manufactured by Alpha Metals Japan Ltd.)
  - M705-221BM5-42-11  
(Sn:Ag:Cu=96.5wt%:3.0wt%:0.5wt%)  
(Manufactured by Senju Metal Industry Co., Ltd.)

- (b) Flow Soldering: NCP18/NCM21 Series  
We are using the solder paste below for any internal tests of this product.
- Sn:Pb=63wt%:37wt%
  - Sn:Ag:Cu=96.5wt%:3.0wt%:0.5wt%

#### (2) Flux

Use Rosin-based flux.  
Do not use strong acidic flux (with halide content exceeding 0.2wt%)

### 5. Cleaning Conditions

For removing the flux after soldering, observe the following points in order to avoid deterioration of the characteristics or any change of the external electrodes' quality.

	NCP15	NCP18/NCM21
<b>Solvent</b>	Isopropyl Alcohol	Isopropyl Alcohol
<b>Dipping Cleaning</b>	Less than 5 mins. at room temp. or less than 2 mins. at 40°C max.	Less than 5 mins. at room temp. or less than 2 mins. at 40°C max.
<b>Ultrasonic Cleaning</b>	Less than 5 mins. 20W/l Frequency of 28 to 40kHz.	Less than 1 min. 20W/l Frequency of several 10 to 100kHz.

### 6. Drying

After cleaning, promptly dry this product.

Continued on the following page. ☐

## for NTC Thermistors Chip Type ⚠Caution/Notice

☒ Continued from the preceding page.

### 7. Printing Conditions of Solder Paste

- The amount of solder is critical. Standard height of fillet is shown in the table below.
- Too much soldering may cause mechanical stress, resulting in cracking, mechanical and/or electronic damage.

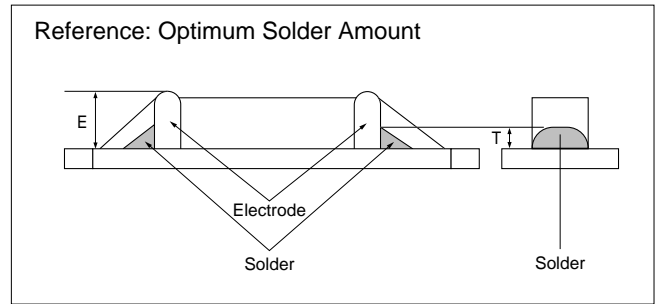

Part Number	The Solder Paste Thickness	T
NCP15	100μm	$1/3E \leq T \leq E$
NCP18	150μm	$0.2\text{mm} \leq T \leq E$
NCM21	150-200μm	$0.2\text{mm} \leq T \leq E$

### 8. Adhesive Application and Curing

- Thin or insufficient adhesive may result in loose component contact with land during flow soldering.
- Low viscosity adhesive causes chips to slip after mounting.

#### ■ Notice (Handling)

The ceramic of this product is fragile, and care must be taken not to load a excessive press-force or not to give a shock at handling.

Such forces may cause cracking or chipping.

# NTC/PTC Thermistors for Automotive



## NTC Thermistor Lead Type for Temperature Sensor

This product is a sensor type NTC Thermistor to be useful in the normal temperature range developed by the unique ceramic technology and the automatic assembly.

### ■ Features

1. High-accuracy of +/-1%  
+/-1% of resistance and B-Constant tolerance is realized due to uniform thickness by the precise sheet forming method.
2. Quick response  
This product provides faster response time due to its smaller size.
3. Taping type is available.
4. Strong lead strength  
Original lead-wiring technique assures reliable connection. It can be formed and bent flexibly according to the mounting condition.

### ■ Applications

1. Car audio, car navigation
2. Various engine control unit
3. Circuits for ETC equipment
4. Various motor driving circuits
5. Temperature compensation for various circuits

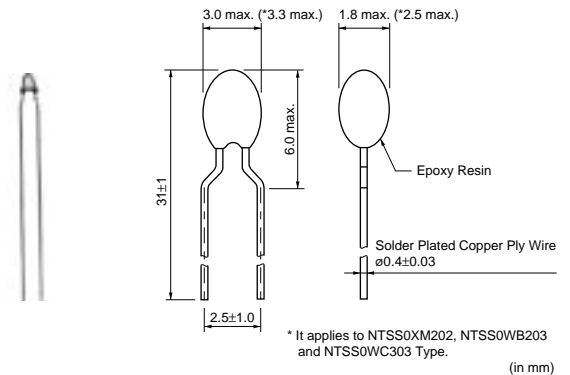

Part Number	Resistance (25°C) (k ohm)	B-Constant (25-50°C) (K)	Permissible Operating Current (25°C) (mA)	Rated Electric Power (25°C) (mW)	Typical Dissipation Constant (25°C) (mW/°C)	Thermal Time Constant (25°C)(s)	Operating Temperature Range (°C)
NTSS0XM202□E1B0	2.0	3500 ±1%	1.05	21	2.1	7	-40 to 125
NTSS0XR502□E1B0	5.0	3700 ±1%	0.68	21	2.1	7	-40 to 125
NTSS0XH103□E1B0	10	3380 ±1%	0.38	15	1.5	7	-40 to 125
NTSS0XV103□E1B0	10	3900 ±1%	0.46	21	2.1	7	-40 to 125
NTSS0WB203□E1B0	20	4050 ±1%	0.31	21	2.1	7	-40 to 125
NTSS0WC303□E1B0	30	4100 ±1%	0.26	21	2.1	7	-40 to 125
NTSS0WD503□E1B0	50	4150 ±1%	0.20	21	2.1	7	-40 to 125
NTSS0WF104□E1B0	100	4250 ±1%	0.14	21	2.1	7	-40 to 125

A blank column is filled with resistance tolerance codes. (F: ±1%, E: ±3%)  
Taping type of part numbers with "N6A0" is available. (Lead spacing=5mm)

### ■ Temperature Tolerance-Temperature Characteristics

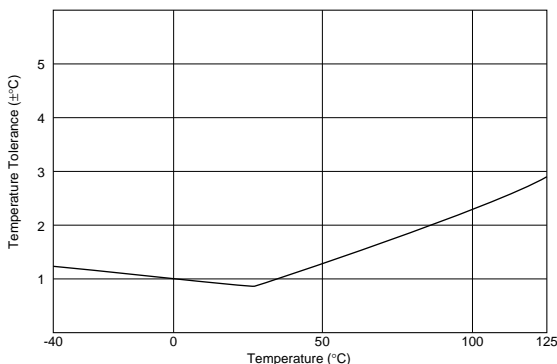

## for NTC Thermistors Lead Type Temperature Characteristics (Center Value)

Part Number	NTS□□XM202	NTS□□XR502	NTS□□XH103	NTS□□XV103	NTS□□WB203	NTS□□WC303	NTS□□WD503	NTS□□WF104
Resistance	2.0kΩ	5.0kΩ	10kΩ	10kΩ	20kΩ	30kΩ	50kΩ	100kΩ
B-Constant	3500K	3700K	3380K	3900K	4050K	4100K	4150K	4250K
Temp. (°C)	Resistance (kΩ)	Resistance (kΩ)	Resistance (kΩ)	Resistance (kΩ)	Resistance (kΩ)	Resistance (kΩ)	Resistance (kΩ)	Resistance (kΩ)
-40	44.657	123.484	195.652	347.808	733.007	1149.500	1948.575	4256.752
-35	33.505	92.295	148.171	248.591	524.831	819.651	1387.289	3005.888
-30	25.388	69.614	113.347	179.973	380.184	591.391	999.456	2148.514
-25	19.402	52.860	87.559	131.832	277.845	430.529	728.895	1555.020
-20	14.961	40.480	68.237	97.679	205.260	316.870	537.039	1137.312
-15	11.644	31.275	53.650	73.119	153.642	236.337	399.167	839.314
-10	9.133	24.339	42.506	55.301	116.016	177.842	299.469	625.338
-5	7.198	19.154	33.892	42.257	88.125	134.630	226.186	469.127
0	5.716	15.148	27.219	32.582	67.522	102.816	172.393	355.224
5	4.571	11.964	22.021	25.324	52.168	79.183	132.857	272.045
10	3.682	9.520	17.926	19.847	40.617	61.460	103.089	209.803
15	2.987	7.624	14.674	15.679	31.847	48.045	80.430	162.713
20	2.437	6.160	12.081	12.478	25.151	37.834	63.201	127.117
25	2.000	5.000	10.000	10.000	20.000	30.000	50.000	100.000
30	1.651	4.082	8.315	8.068	16.014	23.955	39.825	79.215
35	1.371	3.354	6.948	6.552	12.902	19.249	31.918	63.150
40	1.143	2.773	5.834	5.353	10.457	15.560	25.733	50.649
45	0.958	2.299	4.917	4.399	8.527	12.657	20.877	40.885
50	0.807	1.914	4.161	3.635	6.993	10.354	17.034	33.195
55	0.683	1.607	3.535	3.020	5.771	8.525	13.929	27.014
60	0.582	1.356	3.014	2.521	4.789	7.058	11.439	22.079
65	0.497	1.149	2.586	2.115	3.992	5.869	9.485	18.226
70	0.426	0.978	2.228	1.783	3.343	4.905	7.906	15.124
75	0.367	0.834	1.925	1.510	2.809	4.113	6.614	2.598
80	0.318	0.714	1.669	1.284	2.371	3.463	5.558	10.542
85	0.276	0.612	1.452	1.096	2.020	2.945	4.686	8.852
90	0.240	0.527	1.268	0.939	1.729	2.516	3.967	7.463
95	0.210	0.456	1.110	0.808	1.476	2.143	3.373	6.321
100	0.183	0.396	0.974	0.698	1.264	1.832	2.878	5.374
105	0.161	0.345	0.858	0.605	1.085	1.571	2.465	4.585
110	0.142	0.302	0.758	0.527	0.935	1.350	2.118	3.925
115	0.125	0.264	0.671	0.460	0.812	1.171	1.828	3.376
120	0.111	0.232	0.596	0.403	0.708	1.019	1.583	2.913
125	0.099	0.205	0.531	0.354	0.617	0.886	1.374	2.520

4

## for NTC Thermistors Lead Type Specifications and Test Methods

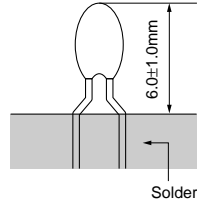
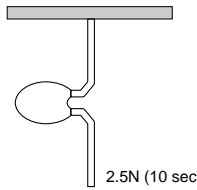
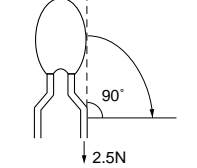
No.	Item	Rating Value	Method of Examination
1	High Temp. Test 1	<ul style="list-style-type: none"> <li>Resistance (R25) fluctuation rate less than <math>\pm 2\%</math></li> <li>B-Constant (B25/50) fluctuation rate less than <math>\pm 1\%</math></li> </ul>	150 $\pm$ 2°C in air, for 500 +48/-0 hrs. without loading
2	High Temp. Test 2		125 $\pm$ 3°C in air, for 1000 +48/-0 hrs. without loading
3	Low Temp. Test	<ul style="list-style-type: none"> <li>Resistance (R25) fluctuation rate less than <math>\pm 1\%</math></li> <li>B-Constant (B25/50) fluctuation rate less than <math>\pm 1\%</math></li> </ul>	-40 $\pm$ 3°C in air, for 1000 +48/-0 hrs. without loading
4	Humidity Test		60 $\pm$ 2°C, 90-95%RH in air, for 1000 +48/-0 hrs. without loading
5	High Temp. Pressure Test		121 $\pm$ 2°C, 2atm. in saturated vapor, leave for 2 +1/-0 hrs. without loading
6	Heat Shock Test	<ul style="list-style-type: none"> <li>Resistance (R25) fluctuation rate less than <math>\pm 2\%</math></li> <li>B-Constant (B25/50) fluctuation rate less than <math>\pm 1\%</math></li> </ul>	-55 $\pm$ 3°C, 30 min. in air 125 $\pm$ 2°C, 30 min. in air (1 cycle) Continuous 1000 +4/-0 cycles without loading
7	High Temp. Continuous Load Test		100 $\pm$ 2°C in air, with Permissive Operating Current for 1000 +48/-0 hrs.
8	Humid Continuous Load Test		85 $\pm$ 2°C, 85%RH in air, with Permissive Operating Current for 1000 +48/-0 hrs.
9	Insulation Break-down Voltage	<ul style="list-style-type: none"> <li>Normal appearance</li> <li>Normal electrical characteristics on 500Vdc, 1 min.</li> </ul>	2mm length of coating resin from the top of thermistor is to be dipped into beads of lead (Pb), and D.C 500V is applied to circuit between beads of lead (Pb) and lead wire.
10	Solvent Proof	<ul style="list-style-type: none"> <li>Normal appearance</li> <li>Resistance (R25) fluctuation rate less than <math>\pm 1\%</math></li> <li>B-Constant (B25/50) fluctuation rate less than <math>\pm 1\%</math></li> </ul>	Using Chlorine Washing Solvents, Boiling, 10 min. Supersonic, 10 min.
11	Resistance to Soldering Heat	<ul style="list-style-type: none"> <li>Resistance (R25) change less than <math>\pm 1\%</math></li> <li>B-Constant (B25/50) change less than <math>\pm 1\%</math></li> </ul>	Both lead wires are immersed into 350 $\pm$ 10°C solder for 3.5 $\pm$ 0.5 seconds or 260 $\pm$ 5°C solder for 10 $\pm$ 1 seconds according to Fig-1. (solder <JIS Z 3282 H60A>)  <div style="text-align: center;">  <p>Fig-1</p> </div>
12	Solderability	More than 90% of lead wire surface should be covered by solder.	Both lead wires are immersed into flux (25wt% colophony <JIS K 5902> isopropyl alcohol <JIS K 8839>) for 5-10 secs. Then both lead wires are immersed into 235 $\pm$ 5°C solder <JIS Z 3282 H60A> for 2 $\pm$ 0.5 seconds. according to Fig-1.
13	Lead Wire Pull Strength	<ul style="list-style-type: none"> <li>No visible damage</li> <li>Resistance (R25) change less than <math>\pm 1\%</math></li> <li>B-Constant (B25/50) change less than <math>\pm 1\%</math></li> </ul>	One end of a lead wire should be fixed and 2.5N force for 10 seconds should be applied to the other lead wire as shown in Fig-2.  <div style="text-align: center;">  <p>Fig-2</p> </div>
14	Lead Wire Bending Strength	No visible damage on lead wire	One lead wire is held and 2.5N force is applied. Then the body of NTC thermistor is bent 90° degrees and again bent back to the initial position. This sequence should be completed twice. See Fig-3.  <div style="text-align: center;">  <p>Fig-3</p> </div>
15	Drop Test		NTC Thermistor should be dropped without any force onto concrete floor from 1 meter height one time.
16	Vibration	<ul style="list-style-type: none"> <li>No visible damage</li> <li>Resistance (R25) change less than <math>\pm 1\%</math></li> <li>B-Constant (B25/50) change less than <math>\pm 1\%</math></li> </ul>	NTC Thermistor is to be fixed to the vibration test equipment. Frequency: 10-2000-10Hz (20 min.) Max amplitude: 3.0mm Vibrated for a period of 4 hrs. in 3 perpendicular directions each other (for total of 12 hrs.)

\* R25 is zero-power resistance of Thermistor in 25°C.

• After each test, NTC Thermistor should be kept for 1 hour at room temperature (normal humidity and normal atmospheric pressure). Then the resistances (R25 and R50) should be measured and the appearance should be visually examined.



## for NTC Thermistors Lead Type ⚠Caution/Notice

### ■ ⚠Caution (Storage and Operating Condition)

This product is designed for application in an ordinary environment (normal room temperature, humidity and atmospheric pressure).

Do not use under the following conditions because all these factors can deteriorate the product characteristics or cause failures and burn-out.

1. Corrosive gas or deoxidizing gas  
(Chlorine gas, Hydrogen sulfide gas, Ammonia gas, Sulfuric acid gas, Nitric oxide gas, etc.)

2. Volatile or flammable gas
3. Dusty conditions
4. Under vacuum, or under high or low-pressure
5. Wet or humid locations
6. Places with salt water, oils, chemical liquids or organic solvents
7. Strong vibrations
8. Other places where similar hazardous conditions exist

### ■ ⚠Caution (Other)

Be sure to provide an appropriate fail-safe function on your product to prevent secondary damages that may be caused by the abnormal function or the failure of our product.

### ■ Notice (Storage and Operating Condition)

To keep solderability of product from declining, the following storage condition is recommended.

1. Storage condition:  
Temperature -10 to +40 degree C  
Humidity less than 75%RH (not dewing condition)
2. Storage term:  
Use this product within 6 months after delivery by first-in and first-out stocking system.

3. Handling after unpacking:  
After unpacking, reseal product promptly or store it in a sealed container with a drying agent.
4. Storage place:  
Do not store this product in corrosive gas (sulfuric acid gas, chlorine gas, etc.) or in direct sunlight.

### ■ Notice (Rating)

Use this product within the specified temperature range.

Higher temperature may cause deterioration of the characteristics or the material quality of this product.

### ■ Notice (Soldering and Mounting)

1. Be sure that the preheat-up does not melt the soldering of this product. Excessive heat may cause failure to open, short or insulation break down.
2. Do not touch the body with soldering iron.  
The soldering point should be min. 5mm away from the root of lead wire.

### ■ Notice (Handling)

1. The ceramic element of this product is fragile, and care must be taken not to load an excessive press-force or not to give a shock at handling. Such forces may cause cracking or chipping.
2. Do not apply an excessive force to the lead. Otherwise, it may cause junction between lead and element to break or crack. Holding element by side lead wire is recommended when lead wire is bent or cut.

# NTC/PTC Thermistors for Automotive



## PTC Thermistor (POSISTOR®) for Overheat Sensing Chip Type 0603 (1608) Size

This chip "POSISTOR" is SMD type for overheat sensing for power transistors, power diodes and power ICs in hybrid circuits.

### ■ Features

1. SMD type is helpful for miniaturizing the circuit because of small size and light weight.
2. Excellent thermal response because of no coating.
3. Elements of solid-state construction provides excellent mechanical vibration and impact resistance.
4. Contactless operation provides prolonged service life and noiseless operation.
5. Lead is not contained in the terminations.

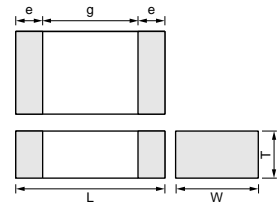

Part Number	Dimensions (mm)				
	L	W	T	e	g
<b>PRF18 RB</b>	1.6±0.15	0.8±0.15	0.8±0.15	0.1 to 0.6	-

Part Number	Sensing Temperature (at 4.7k ohm) (°C)	Maximum Voltage (V)	Resistance (at 25°C) (ohm)	Temperature Range (°C)
<b>PRF18BG471QS2RB</b>	65 ±5°C	32	470 ±50%	-40 to 150
<b>PRF18BF471QS2RB</b>	75 ±5°C	32	470 ±50%	-40 to 150
<b>PRF18BE471QS2RB</b>	85 ±5°C	32	470 ±50%	-40 to 150
<b>PRF18BD471QS2RB</b>	95 ±5°C	32	470 ±50%	-40 to 150
<b>PRF18BC471QS2RB</b>	105 ±5°C	32	470 ±50%	-40 to 150
<b>PRF18BB471QS2RB</b>	115 ±5°C	32	470 ±50%	-40 to 150
<b>PRF18BA471QS2RB</b>	125 ±5°C	32	470 ±50%	-40 to 150
<b>PRF18AR471QS2RB</b>	135 ±5°C	32	470 ±50%	-40 to 150
<b>PRF18AS471QS2RB</b>	145 ±5°C	32	470 ±50%	-40 to 150

5

### ■ Standard Land Pattern Dimensions

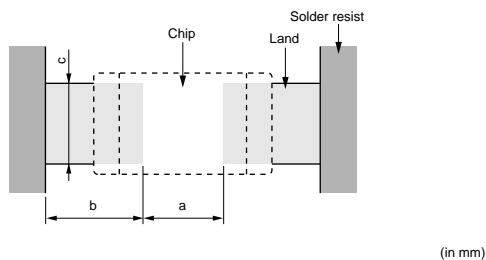

Part Number	Soldering Methods	Dimensions (mm)			
		Chip (L×W)	a	b	c
<b>PRF18</b>	Flow Soldering	1.6×0.8	0.6-1.0	0.8-0.9	0.6-0.8
	Reflow Soldering	1.6×0.8	0.6-0.8	0.6-0.7	0.6-0.8

### ■ Resistance-Temperature Characteristics (Typical)

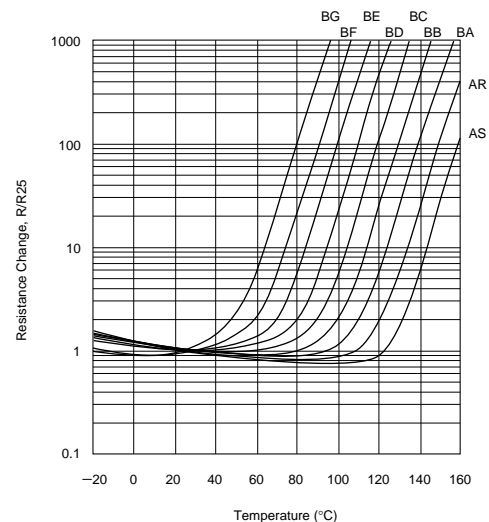

Continued on the following page. ↗

↳ Continued from the preceding page.

■ Overheat Protection Circuit

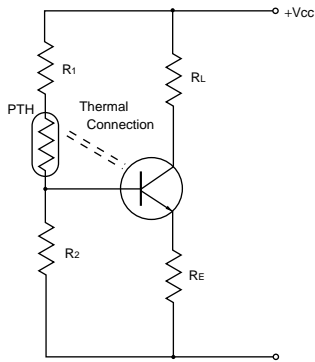

■ Overheat Sensing Circuit

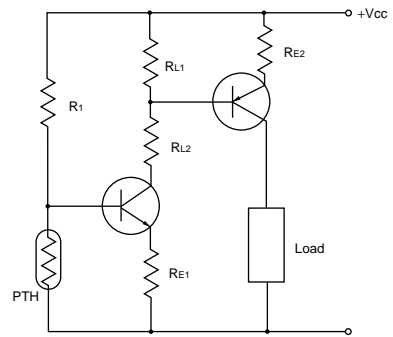

■ Resistance-Temperature Characteristics Range (Ref. Only)

PRF18BG471QS2RB

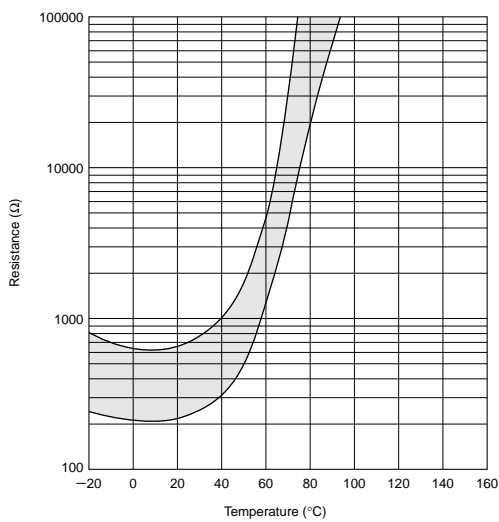

PRF18BF471QS2RB

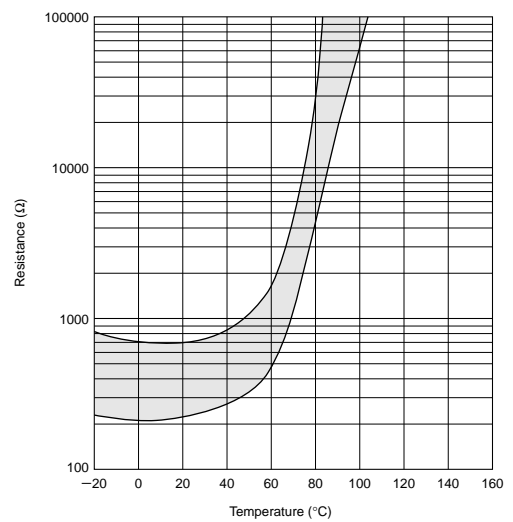

PRF18BE471QS2RB

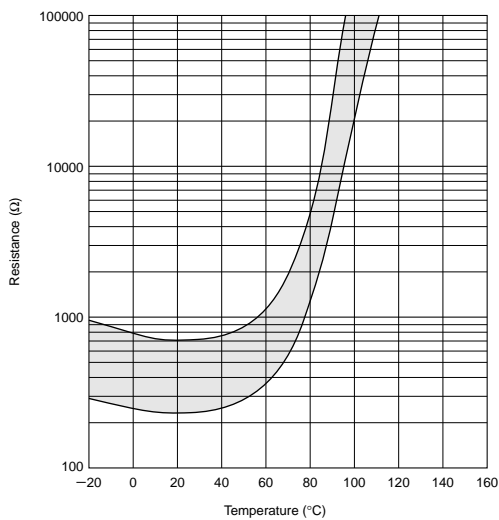

PRF18BD471QS2RB

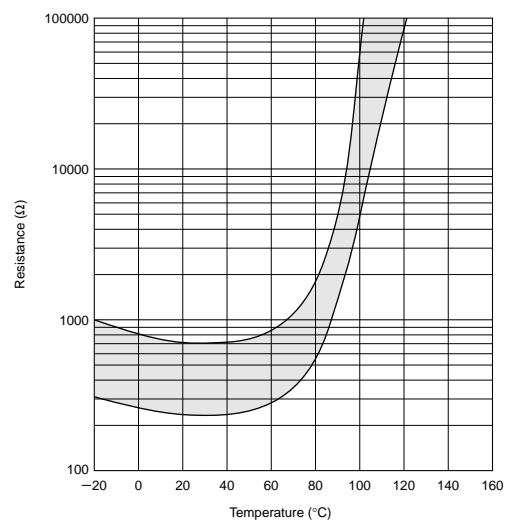

Continued on the following page. ↗

5

↳ Continued from the preceding page.

■ Resistance-Temperature Characteristics Range (Ref. Only)

PRF18BC471QS2RB

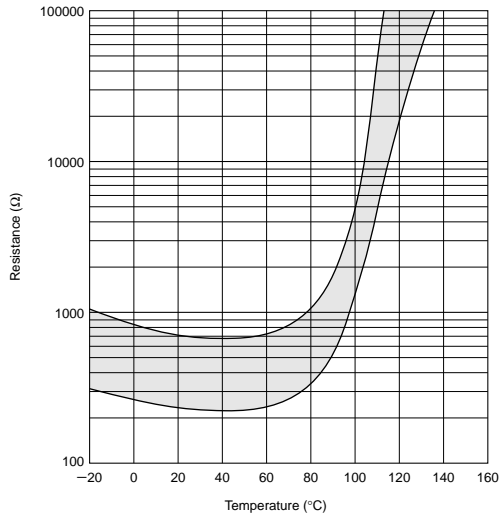

PRF18BB471QS2RB

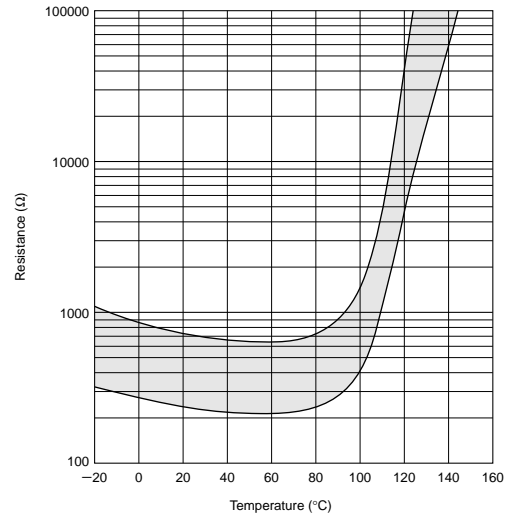

PRF18BA471QS2RB

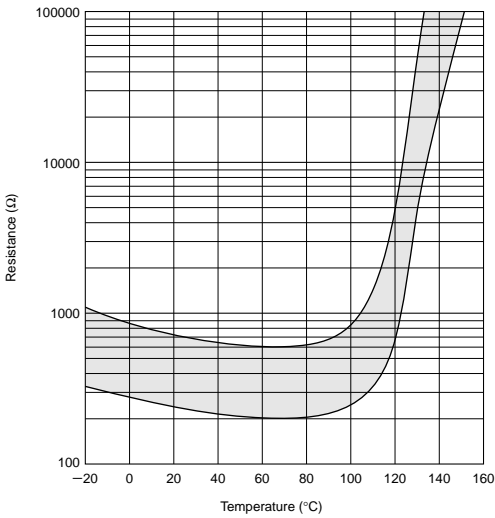

PRF18AR471QS2RB

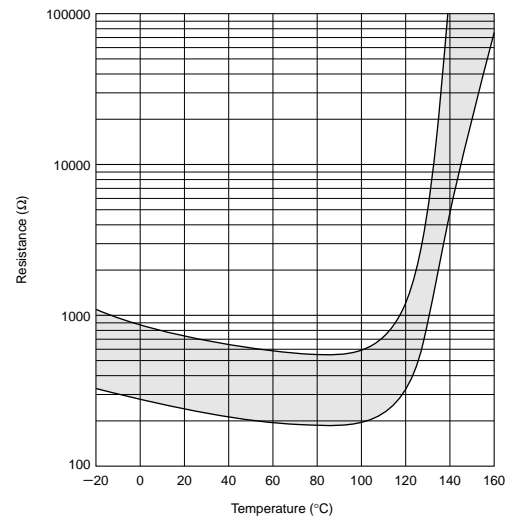

PRF18AS471QS2RB

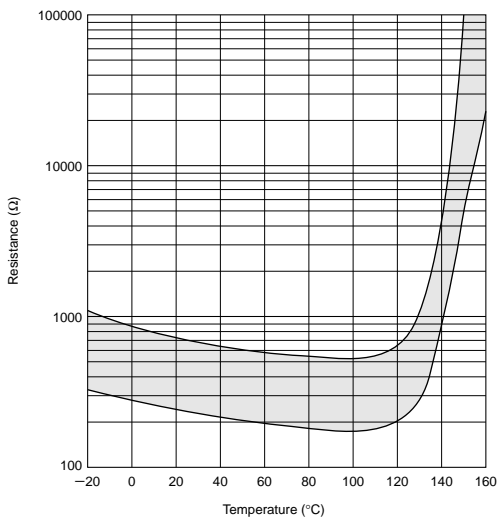

5

## Chip Type of POSISTOR® for Overheat Protection Specifications and Test Methods

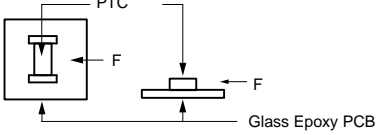
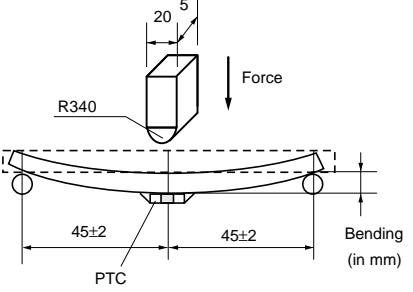
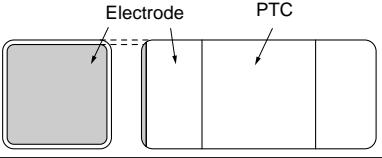
No.	Item	Rating Value	Method of Examination									
1	Resistance Value (at 25°C)	The resistance value should be within the specified tolerance.	After applying max. operating voltage for 3 mins. and leaving for 2 hrs. at 25°C, measured by applying voltage of less than 1.5Vdc (by a direct current less than 10mA).									
2	Adhesive Strength	There is no detachment sign of electrode.	EIAJ ET-7403 term 9 Prepare soldered PTC to PCB *1 and add the force of 5.0N in the direction shown below. (PTC=POSISTOR®) 									
3	Vibration Resistance	Normal appearance Resistance change: not exceed $\pm 20\%$ *2	Soldered PTC to PCB *1 Vibration: 10-2000-10Hz (20 min.) Max. Amplitude: 3.0mm Vibrate for 4 hrs. in each of 3 mutually perpendicular planes for a total of 12 hrs. This test condition is according to "MIL-STD-204D"									
4	Resistance to Bending of Substance	Normal appearance Resistance change: not exceed $\pm 20\%$ *2	Soldered PTC on Test Board *1, and apply force on back side of Test Board shown below: Bending Speed: 1.0mm/s Bending Strength: 2.0mm Hold time: $5 \pm 1$ sec. Board Dimension: $100 \times 40 \times 1.6t$ mm Board Material: Glass Epoxy 									
5	Solderability	Min. 95% electrode is covered with new solder. Resistance change: not exceed $\pm 20\%$ *2	JIS C 5102 term 8.4 Solder temp.: $230 \pm 5^\circ\text{C}$ Solder: Sn63%/Pb37% (or 60%/40%) Soaking time: $3 \pm 0.5$ secs. Soaking position: Until a whole electrode is soaked									
6	Soldering Heat Resistance	Resistance change: not exceed $\pm 20\%$ *2 Normal appearance on the section showed by slanting line parts of the electrodes on the figure. 	Solder temp.: $260 \pm 5^\circ\text{C}$ Solder: Sn63%/Pb37% (or 60%/40%) Flux: Containing less than 0.2wt% of chlorine. Soaking time: $10 \pm 0.5$ secs. Soaking position: Until a whole electrode is soaked. Preheating: $150 \pm 5^\circ\text{C}$ 3 mins.									
7	Dry Heat Resistance	Normal appearance Resistance change: not exceed $\pm 20\%$ *2	Soldered PTC to PCB. *1 $+150 \pm 3^\circ\text{C}$ leave for $1000 \pm 12$ hrs.									
8	Cold Resistance		Soldered PTC to PCB. *1 $-40 \pm 3^\circ\text{C}$ leave for $1000 \pm 12$ hrs.									
9	Damp Heat Resistance		Soldered PTC to PCB. *1 $+85 \pm 3^\circ\text{C}$ 80-85%RH leave for $1000 \pm 12$ hrs.									
10	Thermal Shock *3		Soldered PTC to PCB. *1 Cycles: 1000 cycles <table border="1" style="margin-left: auto; margin-right: auto;"> <thead> <tr> <th>Step</th> <th>Temp. (°C)</th> <th>Time (min.)</th> </tr> </thead> <tbody> <tr> <td>1</td> <td>-55+0, -3</td> <td>30</td> </tr> <tr> <td>2</td> <td>+125+3, -0</td> <td>30</td> </tr> </tbody> </table>	Step	Temp. (°C)	Time (min.)	1	-55+0, -3	30	2	+125+3, -0	30
Step	Temp. (°C)		Time (min.)									
1	-55+0, -3	30										
2	+125+3, -0	30										
11	High Temperature Humidity Load	Soldered PTC to PCB. *1 $85 \pm 3^\circ\text{C}$ , 80-85%RH (in air), load max. operating voltage for $1000 \pm 12$ hrs.										

Continued on the following page.

## Chip Type of POSISTOR<sup>®</sup> for Overheat Protection Specifications and Test Methods

☐ Continued from the preceding page.

No.	Item	Rating Value	Method of Examination
12	High Temperature Load	Normal appearance Resistance change: not exceed $\pm 20\%$ *2	Soldered PTC to PCB. *1 +85 $\pm$ 3°C (in air), load max. operating voltage for 1000 $\pm$ 12 hrs.

\*1 Above mentioned soldering is done under the following conditions at our side.

- Glass-Epoxy PC board
- Recommendable land dimension
- Recommendable solder paste
- Recommendable solder profile

Above conditions are mentioned in Notice.

\*2 Measure resistance after the test. by applying voltage less than 1.5Vdc. by a direct current of less than 10mA. after product is left at 25 $\pm$ 2°C for 2hrs.

\*3 We cannot guarantee the resistance change in Thermal Shock (No.10) in case of defective mounting.

# NTC/PTC Thermistors for Automotive



## PTC Thermistor (POSISTOR®) for Overcurrent Protection Chip Type 0805 (2012) Size

Overcurrent Protection device with resettable function suitable for current limiting resistor.

This product is chip type PTC thermistor for overcurrent protection which is suitable for the following

- Countermeasure for short circuit testing
- Current limiting resistor

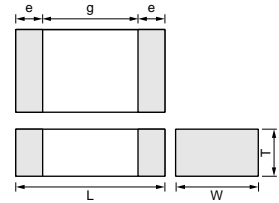

Part Number	Dimensions (mm)				
	L	W	T	e	g
<b>PRG18_RB</b>	1.6±0.15	0.8±0.15	0.8±0.15	0.1 to 0.6	-
<b>PRG21_RA</b>	2.0±0.2	1.25±0.2	0.9±0.2	0.2 min.	0.5 min.
<b>PRG21_RK</b>	2.0±0.2	1.25±0.2	1.25±0.2	0.2 min.	0.5 min.

### ■ Features

1. Rapid operation to protects the circuit in an overcurrent condition abnormality such as a short circuit.  
By removing the overcurrent condition, these products automatically return to the initial condition and can be used repeatedly.
2. Suitable for countermeasure to short circuit test in safety standard.
3. Stable resistance after operation due to ceramic PTC.
4. Similar size (0603 size) is possible due to the large capacity for electric power.
5. Possible to use these products as current limiting resistors with overcurrent protection functions.
6. SMD type is helpful for miniaturizing circuits because of its small size and light weight.
7. Lead is not contained in the terminations.

6

Part Number	Max. Voltage (V)	Non-operating Current (at +85°C) (mA)	Non-operating Current (at +105°C) (mA)	Trip Current (at -40°C) (mA)	Max. Current (mA)	Resistance (at 25°C) (ohm)	Curie Point (°C)	Temperature Range (°C)
<b>PRG21AR420MS1RA</b>	20	25	15	130	590	42 ±20%	120 (AR)	-40 to 105
<b>PRG21AR220MS1RK</b>	16	45	25	250	900	22 ±20%	120 (AR)	-40 to 105

### ■ Standard Land Pattern Dimensions

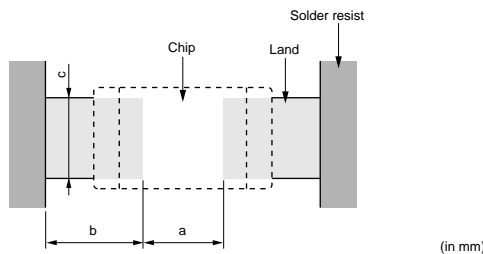

Part Number	Soldering Methods	Dimensions (mm)			
		Chip (L×W)	a	b	c
<b>PRG18</b>	Reflow Soldering	1.6×0.8	0.6-0.8	0.6-0.7	0.6-0.8
<b>PRG21</b>	Reflow Soldering	2.0×1.25	1.0-1.2	0.5-0.7	1.0-1.2

### ■ Protective Threshold Current Range

PRG21AR220MS1RK

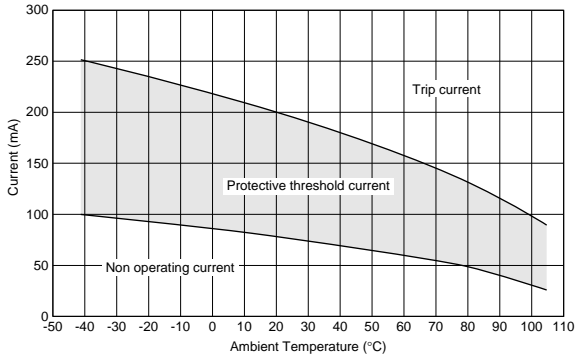

PRG21AR420MS1RA

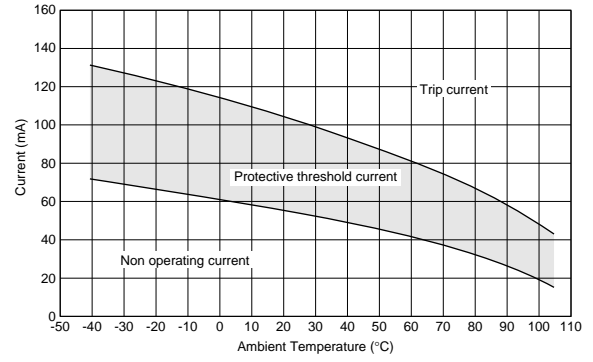

### ■ Operating Time (Typical Curve)

PRG21AR220MS1RK

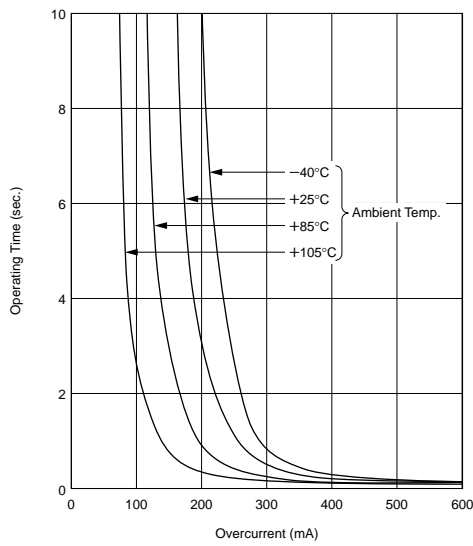

PRG21AR420MS1RA

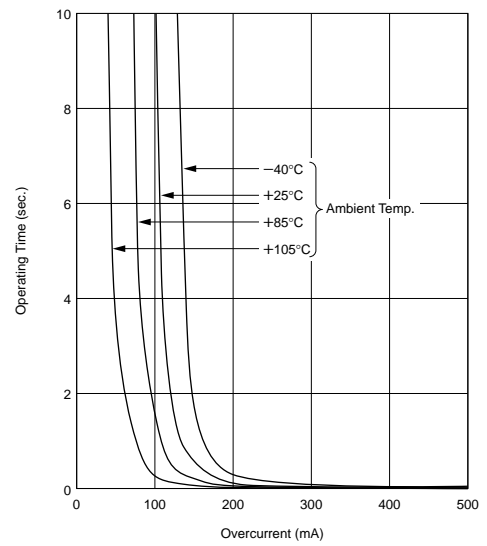

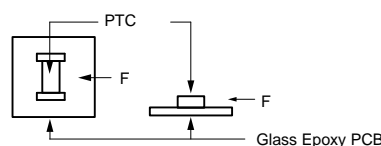
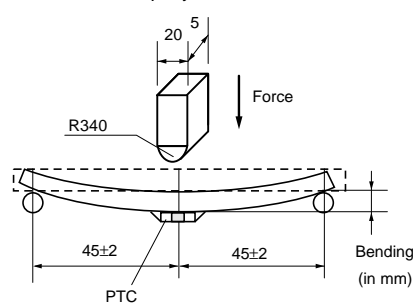

## Chip Type of POSISTOR® for Overheat Protection Specifications and Test Methods

No.	Item	Rating Value	Method of Examination								
1	Operating Temp. 1	-40 to +105°C	The temperature range with maximum voltage applied the POSISTOR®.								
2	Operating Temp. 2	-40 to +125°C	The temperature range which with zero voltage applied to POSISTOR® after it was soldered to PCB.								
3	Resistance Value (at 25°C)	The resistance value shall be within the specified tolerance.	After applying maximum Operating voltage for 3 minutes and leaving for 2 hours at 25°C, measured by applying voltage of less than 1.5Vdc (by a direct current less than 10mA).								
4	Withstanding Voltage	Without damage	We apply 120% of the maximum voltage to PTC by rising gradually for 180±5 seconds at 25°C. (A protective resistor is to be connected in series, and the inrush current through PTC must be limited below maximum rated value.)								
5	Adhesive Strength	There is no detachment sign of electrode.	EIAJ ET-7403 term 9 Prepare soldered PTC to PCB *1 and add the force of 5.0N in the direction shown below. (PTC=POSISTOR®) 								
6	Vibration Resistance	Normal appearance Resistance change: not exceed ±20% *2	Soldered PTC to PCB *1 Vibration: 10-2000-10Hz (20 min.) Max. Amplitude: 3.0mm Vibrate for 4 hours in each of 3 mutually perpendicular planes for a total of 12 hours. This test condition is according to "MIL-STD-204D"								
7	Resistance to Bending of Substance	Normal appearance Resistance change: not exceed ±20% *2	Soldered PTC on Test Board *1, and apply force on back side of Test Board shown below: Bending Speed: 1.0mm/s Bending Strength: 2.0mm Hold Time: 5±1 sec. Board Dimension: 100×40×1.6t mm Board Material: Glass Epoxy 								
8	Solderability	Min. 95% electrode is covered with new solder. Resistance change: not exceed ±20% *2	JIS C 5102 term 8.4 Solder Temp.: 230±5°C Solder: Sn63%/Pb37% (or 60%/40%) Soaking Time: 3±0.5 sec. Soaking Position: Until a whole electrode is soaked								
9	Soldering Heat Resistance	Normal appearance Resistance change: not exceed ±20% *2	Solder: Sn 63/37 Pb (or 60/40) solder paste Containing less than 0.2wt% of chlorine. Preheating: 150±5°C 3 min. Peak Temp.: 260±5°C 10±5 sec. (reflow) PCB: JIS C 6484 Glass Epoxy PCB								
10	Dry Heat Resistance	Normal appearance Resistance change: not exceed ±20% *2	Soldered PTC to PCB. *1 +125±3°C leave for 1000±12 hours.								
11	Cold Resistance		Soldered PTC to PCB. *1 -40±3°C leave for 1000±12 hours.								
12	Damp Heat Resistance		Soldered PTC to PCB. *1 +85±3°C 80-85%RH leave for 1000±12 hours.								
13	Thermal Shock *3		Soldered PTC to PCB. *1 Cycles: 1000 cycles <table border="1" style="width: 100%; border-collapse: collapse;"> <thead> <tr> <th>Step</th> <th>Temp. (°C)</th> <th>Time (min.)</th> </tr> </thead> <tbody> <tr> <td>1</td> <td>-55+0, -3</td> <td>30</td> </tr> <tr> <td>2</td> <td>+125+3, -0</td> <td>30</td> </tr> </tbody> </table>	Step	Temp. (°C)	Time (min.)	1	-55+0, -3	30	2	+125+3, -0
Step	Temp. (°C)	Time (min.)									
1	-55+0, -3	30									
2	+125+3, -0	30									

Continued on the following page. ↗

## Chip Type of POSISTOR<sup>®</sup> for Overheat Protection Specifications and Test Methods

↳ Continued from the preceding page.

No.	Item	Rating Value	Method of Examination
14	High Temperature Humidity Load	Normal appearance Resistance change: not exceed $\pm 20\%$ *2	Soldered PTC to PCB. *1 85 $\pm 3^{\circ}\text{C}$ , 80-85%RH (in air), load max. operating voltage for 1000 $\pm 12$ hrs.
15	High Temperature Load		Soldered PTC to PCB. *1 125 $\pm 3^{\circ}\text{C}$ (in air), PTC is applied max. operating voltage for 1.5 hrs on and 0.5 hrs off. This cycle is repeated for 1000 $\pm 10$ hrs.

\*1 Above mentioned soldering is done under the following conditions at our side.

- Glass-Epoxy PC board
  - Recommendable land dimension
  - Recommendable solder paste
  - Recommendable solder profile
- Above conditions are mentioned in Notice.

\*2 Measure resistance after the test. by applying voltage less than 1.5Vdc. by a direct current of less than 10mA. after product is left at 25 $\pm 2^{\circ}\text{C}$  for 2hrs.

\*3 We cannot guarantee the resistance change in Thermal Shock (No.10) in case of defective mounting.

## for POSISTOR<sup>®</sup> Chip Type ⚠Caution/Notice

### ■ ⚠Caution (Storage and Operating Condition)

This product is designed for application in an ordinary environment (normal room temperature, humidity and atmospheric pressure). Do not use under the following conditions because all these factors can deteriorate the characteristics or cause product failure and burn-out.

1. Corrosive gas or deoxidizing gas (Chlorine gas, Hydrogen sulfide gas, Ammonia gas, Sulfuric acid gas, Nitric oxide gas, etc.)
2. Volatile or flammable gas
3. Dusty conditions
4. Under vacuum, or under high or low-pressure
5. Wet or humid conditions
6. Places with salt water, oils, chemical liquids or organic solvents
7. Strong vibrations
8. Other places where similar hazardous conditions exist

### ■ ⚠Caution (Other)

Be sure to provide an appropriate fail-safe function on your product to prevent secondary damage that may be caused by the abnormal function or the failure of our product.

### ■ Notice (Storage and Operating Condition)

To keep solderability of product from declining, following storage condition is recommended.

1. Storage condition:
  - Temperature -10 to +40 degree C
  - Humidity less than 75%RH (not dewing condition)
2. Storage term:
  - Use this product within 6 months after delivery by first-in and first-out stocking system.
3. Handling after unpacking:
  - After unpacking, promptly reseal this product or store it in a sealed container with a drying agent.
4. Storage place:
  - Do not store this product in corrosive gas (sulfuric acid, chlorine, etc.) or in direct sunlight.

for POSISTOR<sup>®</sup> Chip Type ⚠️Caution/Notice

■ Notice (Soldering and Mounting) 0603 (1608) Size

1. Solder and Flux

(1) Solder Paste

(a) Flow Soldering : Use Sn:Pb=60:40wt%,  
Sn:Pb=63:37wt%, Sn:Ag:Cu=96.5:3.0:0.5wt% or  
equivalent type of solder.

(b) Reflow Soldering : Use Sn:Pb=60:40wt%,  
Sn:Pb=63:37wt%, Sn:Ag:Cu=96.5:3.0:0.5wt% or  
equivalent type of solder paste.

For your reference, we are using '63Sn/37Pb  
RMA9086 90-3-M18', manufactured by Alpha Metals  
Japan Ltd., '96.5Sn/3.0Ag/0.5Cu M705-221BM5-42-  
11', manufactured by Senju Metal Industry Co., Ltd.  
for any Internal tests of this product.

(2) Flux

Use rosin-based flux. Do not use strong acidic flux (with  
halide content exceeding 0.2wt%).

2. Cleaning Conditions and Drying

To remove the flux after soldering, observe the following  
points in order to avoid deterioration of the characteristics  
or any change to the external electrodes quality.

(1) Cleaning Conditions

Solvent	Dipping Cleaning	Ultrasonic Cleaning
2-propanol	Less than 5 min. at room temp. or Less than 2 min. at 40°C max.	Less than 1 min. 20W/L Frequency of several 10kHz to 100kHz.

A sufficient cleaning should be applied to remove flux completely.

(2) Drying

After cleaning, promptly dry this product.

3. Soldering Conditions

In your mounting process, observe the following points in  
order to avoid deterioration of the characteristics or  
destruction of this product. The mounting quality of this  
product may also be affected by the mounting conditions,  
shown in the points below.

(1) Printing Conditions of Solder Paste

- (a) Recommendable thickness of solder paste printing  
should be from 0.15 to 0.20mm.
- (b) After soldering, the solder fillet should be a height  
from 0.2 mm to the thickness of this product (see the  
figure at right).
- (c) Too much solder gives too strong mechanical stress  
to this product. Such stress may cause cracking or  
other mechanical damage. Also, it can destroy the  
electrical performance of this product.

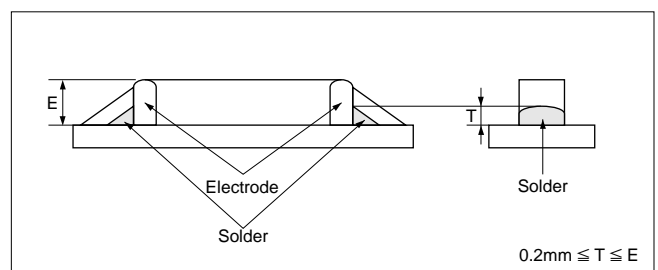

Continued on the following page. ↗

**for POSISTOR<sup>®</sup> Chip Type ⚠Caution/Notice**

☐ Continued from the preceding page.

**(2) Adhesive Application and Curing**

- (a) If insufficient adhesive is applied, or if the adhesive is not sufficiently hardened, this product may have a loose contact with the land, during flow soldering.
- (b) Too low viscosity of adhesive causes this product to slip on board, after mounting.

**(3) Allowable Soldering Temperature and Time**

- (a) Solder within the temperature and time combinations, indicated by the slanted lines in the following graphs.
- (b) The excessive soldering conditions may cause dissolution of metallization or deterioration of solder-wetting on the external electrode.
- (c) In the event that soldering is repeated more than twice, the allowable reflow soldering time should be the accumulated soldering time.

[Allowable Flow Soldering Temp. and Time]

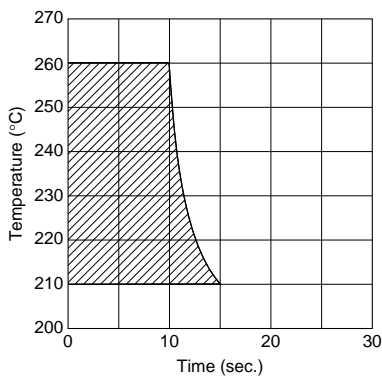

[Allowable Reflow Soldering Temp. and Time]

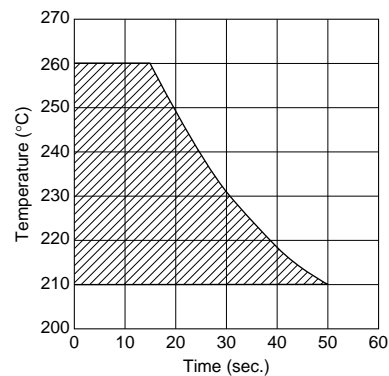

**(4) Recommendable Temperature Profile for Soldering**

- (a) Insufficient preheating may cause a crack on ceramic body. Difference between preheating temperature and maximum temperature in the profile should be 100°C.
- (b) Rapid cooling by dipping in solvent or by other means is not recommended.

[Flow Soldering Condition]

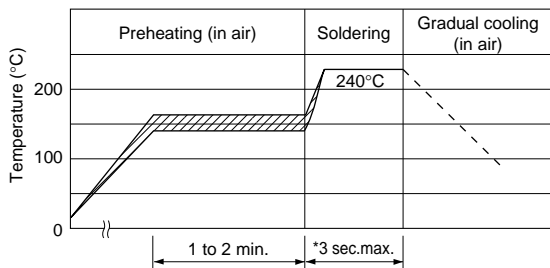

Preheating: 150±10°C, 1 min. to 2 min.  
Soldering: 240°C, 3 sec. max.

\* In the event that soldering is repeated more than twice the accumulated soldering time should be in the above allowable soldering time (3).

[Reflow Soldering Condition]

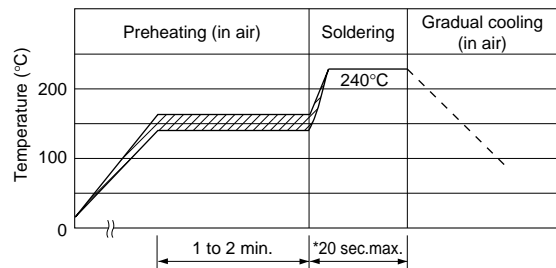

Preheating: 150±10°C, 1 min. to 2 min.  
Soldering: 240°C, 20 sec. max.

\* In the event that soldering is repeated more than twice the accumulated soldering time should be in the above allowable soldering time (3).

- (5) There may be a risk of unexpected failures (tombstone, insufficient solder-wetting, etc.) in the mounting process caused by the mounting conditions. Please make sure that this product is correctly mounted under specified mounting conditions.

for POSISTOR<sup>®</sup> Chip Type ⚠️Caution/Notice

■ Notice (Soldering and Mounting) 0805 (2012) Size

1. Solder and Flux

(1) Solder Paste

Use solder paste Sn:Pb=63:37wt%.

For your reference, we are using

63Sn/37Pb RMA9086 90-3-M18,

manufactured by Alpha Metals Japan Ltd.

96.5Sn/3.0Ag/0.5Cu M705-221BM5-42-11,

manufactured by Senju Metal Industry Co., LTD for any

Internal tests of this product.

(2) Flux

Use rosin-based flux. Do not use strong acidic flux

(with halide content exceeding 0.2wt%).

2. Cleaning Conditions and Drying

To remove the flux after soldering, observe the following points in order to avoid deterioration of the characteristics or any change to the external electrodes quality.

(1) Cleaning Conditions

Solvent	Dipping Cleaning	Ultrasonic Cleaning
2-propanol	Less than 5 min. at room temp. or Less than 2 min. at 40°C max.	Less than 1 min. 20W/L Frequency of several 10kHz to 100kHz.

A sufficient cleaning should be applied to remove flux completely.

(2) Drying

After cleaning, promptly dry this product.

3. Soldering Conditions

In your mounting process, observe the following points in order to avoid deterioration of the characteristics or destruction of this product. The mounting quality of this product may also be affected by the mounting conditions, shown in the points below.

This product is for only reflow soldering. Flow soldering should not be allowed.

(1) Printing Conditions of Solder Paste

- (a) Standard thickness of solder paste printing should be from 0.15 to 0.20 mm.
- (b) After soldering, the solder fillet should be a height from 0.2 mm to the thickness of this product (see the figure at right).
- (c) Too much solder gives too strong mechanical stress to this product. Such stress may cause cracking or other mechanical damage. Also, it can destroy the electrical performance of this product.

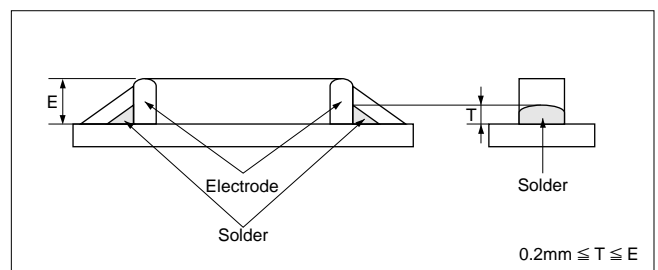

Continued on the following page. ↗

**for POSISTOR<sup>®</sup> Chip Type ⚠Caution/Notice**

☐ Continued from the preceding page.

(2) Allowable Soldering Temperature and Time

- (a) Solder within the temperature and time combinations, indicated by the slanted lines in the right graphs.
- (b) The excessive soldering conditions may cause dissolution of metallization or deterioration of solder-wetting on the external electrode.
- (c) In the event that soldering is repeated more than twice, the allowable reflow soldering time should be the accumulated soldering time.

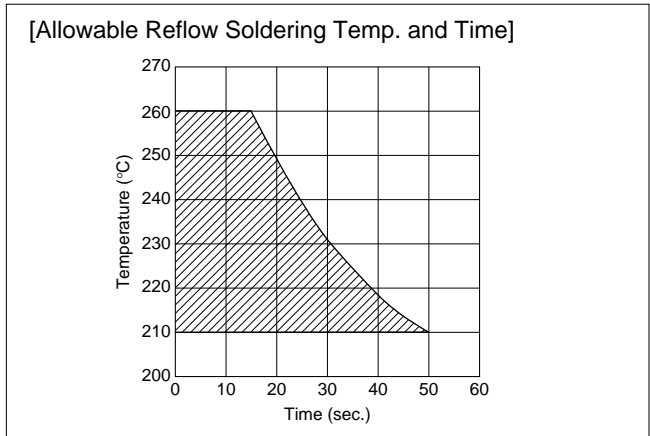

(3) Standard Temperature Profile for Soldering

- (a) Insufficient preheating may cause a crack on ceramic body. Difference between preheating temperature and maximum temperature in the profile should be 100°C.
- (b) Rapid cooling by dipping in solvent or by other means is not recommended.

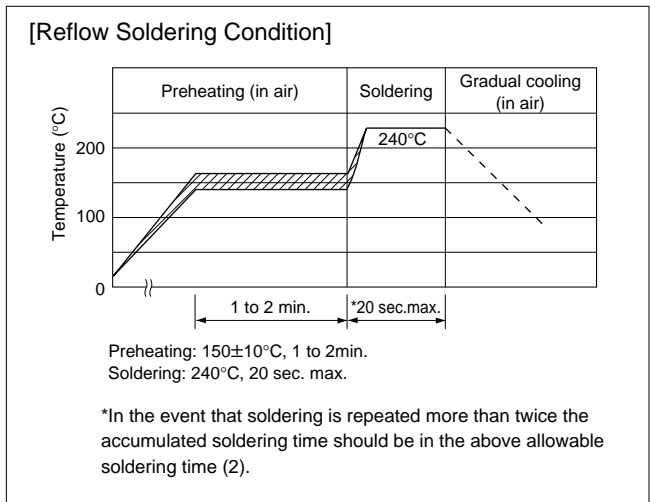

- (4) There may be a risk unexpected failures (tombstone, insufficient solder-wetting, etc.) in the mounting process, caused by the mounting conditions. Please make sure that this product is correctly mounted under specified mounting conditions.

## for POSISTOR<sup>®</sup> Chip Type ⚠Caution/Notice

### ■ Notice (Handling)

1. Do not give this product a strong press-force nor a mechanical shock, because such mechanical forces may cause cracking or chipping of this ceramic product.
2. Rapid cooling or heating during soldering is not recommended.  
Such treatment may destroy the element.
3. Resin coating  
Please select a resin material with minimum hardness shrinkage is much less, on selecting a resin material.
4. Location on Printed Circuit Board (PC Board)  
Choose a mounting position that minimizes the stress imposed on the chip during flexing or bending of the board.

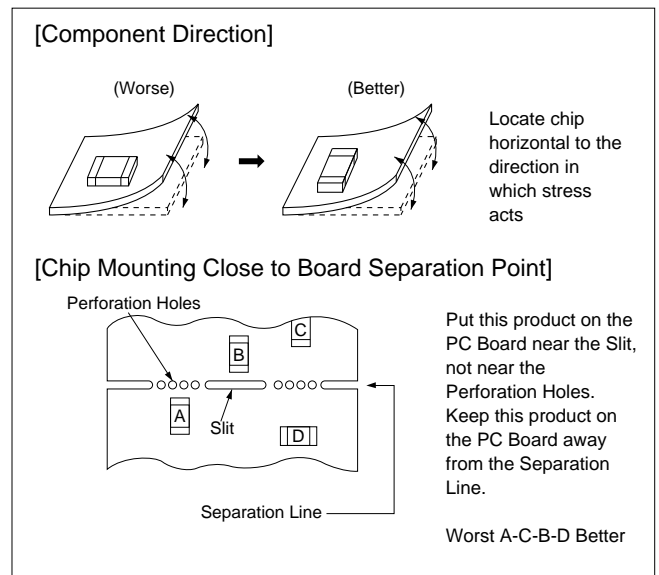



# NTC/PTC Thermistors for Automotive



## PTC Thermistor (POSISTOR®) for Overcurrent Protection Lead Type

New leaded type "POSISTOR" for overcurrent protection as automotive grade can be used with wide temperature range. This product is suitable for short-circuit and current limiting resistor on power supply equipment.

### ■ Features

1. This product has useful Protective threshold current range with wide temperature range.
2. Small fluctuation in the circuit due to resistance tolerance +/-10%.
3. Quick operating time due to small size compared with conventional products.
4. Best suited to meet the requirements for power supply and motor protector. Error-free operations are assured by rush current.
5. Circuit is protected until current is turned off.
6. Restores the original low resistance value automatically once the overload is removed.
7. Non-contact design leads to long life and no noise.  
Durable and strong against mechanical vibration and shock because it is a solid element.
8. Lead (Pb) is not contained in the terminations.

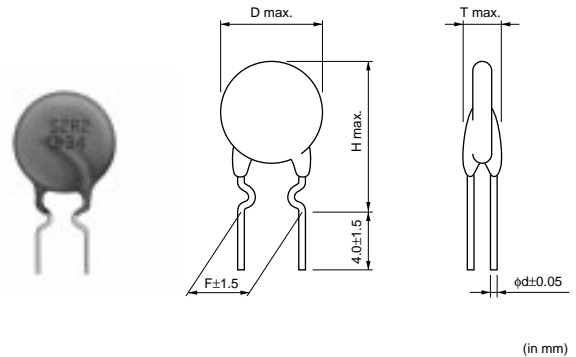

Part Number	Max. Voltage (V)	Non-operating Current (at +85°C) (mA)	Non-operating Current (at +105°C) (mA)	Trip Current (at -40°C) (mA)	Max. Current (A)	Resistance (at 25°C) (ohm)	Curie Point (°C)	Temperature Range (°C)	Body Diameter (D) (mm)	Thickness (T) (mm)	Height (H) (mm)	Lead Space (F) (mm)	Lead Diameter (phi d)(mm)
PTGL4SAS100K2N51B0	30	92	65	261	1.5	10 ±10%	130 (AS)	-40 to 125	4.5	3.5	9.5	5.0	0.5
PTGL4SAS100K2B51B0	30	127	89	359	2.0	10 ±10%	130 (AS)	-40 to 125	4.5	3.5	9.5	5.0	0.6
PTGL5SAS3R9K2B51B0	30	204	143	576	3.5	3.9 ±10%	130 (AS)	-40 to 125	5.5	3.5	10.5	5.0	0.6
PTGL7SAS2R7K2B51B0	30	255	179	720	4.5	2.7 ±10%	130 (AS)	-40 to 125	7.3	3.5	12.3	5.0	0.6
PTGL7SAS1R8K2B51B0	30	319	223	902	5.0	1.8 ±10%	130 (AS)	-40 to 125	7.3	3.5	12.3	5.0	0.6
PTGL9SAS1R2K2B51B0	30	422	296	1193	6.0	1.2 ±10%	130 (AS)	-40 to 125	9.3	3.5	14.3	5.0	0.6
PTGLCSAS0R8K2B51B0	30	520	364	1470	7.0	0.8 ±10%	130 (AS)	-40 to 125	11.5	3.5	16.5	5.0	0.6
PTGL4SAS100K3B51B0	51	128	89	361	1.0	10 ±10%	130 (AS)	-40 to 125	4.5	3.5	9.5	5.0	0.6
PTGL5SAS6R8K3B51B0	51	149	105	422	1.5	6.8 ±10%	130 (AS)	-40 to 125	5.5	3.5	10.5	5.0	0.6
PTGL7SAS3R3K3B51B0	51	233	163	659	3.0	3.3 ±10%	130 (AS)	-40 to 125	7.3	3.5	12.3	5.0	0.6
PTGL9SAS2R2K3B51B0	51	313	219	885	4.0	2.2 ±10%	130 (AS)	-40 to 125	9.3	3.5	14.3	5.0	0.6
PTGLCSAS1R2K3B51B0	51	449	315	1270	5.0	1.2 ±10%	130 (AS)	-40 to 125	11.5	3.5	16.5	5.0	0.6
PTGL4SAS220K4N51B0	60	67	47	190	1.0	22 ±10%	130 (AS)	-40 to 125	4.5	3.5	9.5	5.0	0.5
PTGL4SAS220K4B51B0	60	87	61	246	1.0	22 ±10%	130 (AS)	-40 to 125	4.5	3.5	9.5	5.0	0.6
PTGL5SAS100K4B51B0	60	129	90	364	1.5	10 ±10%	130 (AS)	-40 to 125	5.5	3.5	10.5	5.0	0.6
PTGL7SAS5R6K4N51B0	60	142	99	400	2.2	5.6 ±10%	130 (AS)	-40 to 125	7.3	3.5	12.3	5.0	0.5
PTGL7SAS5R6K4B51B0	60	174	122	492	3.0	5.6 ±10%	130 (AS)	-40 to 125	7.3	3.5	12.3	5.0	0.6
PTGL9SAS3R3K4B51B0	60	253	177	714	4.0	3.3 ±10%	130 (AS)	-40 to 125	9.3	3.5	14.3	5.0	0.6
PTGLCSAS2R2K4B51B0	60	334	234	942	5.0	2.2 ±10%	130 (AS)	-40 to 125	11.5	3.5	16.5	5.0	0.6
PTGL4SAS560K6B51B0	140	56	39	159	0.5	56 ±10%	130 (AS)	-40 to 125	5.5	4.5	10.5	5.0	0.6
PTGL5SAS270K6B51B0	140	80	56	227	1.0	27 ±10%	130 (AS)	-40 to 125	5.5	4.5	10.5	5.0	0.6
PTGL7SAS150K6B51B0	140	112	79	317	1.5	15 ±10%	130 (AS)	-40 to 125	7.3	4.5	12.3	5.0	0.6
PTGL9SAS120K6B51B0	140	146	102	413	2.0	12 ±10%	130 (AS)	-40 to 125	9.3	4.5	14.3	5.0	0.6
PTGL9SAS7R6K6B51B0	140	172	121	486	2.2	7.6 ±10%	130 (AS)	-40 to 125	9.3	4.5	14.3	5.0	0.6
PTGLCSAS4R7K6B51B0	140	236	165	666	3.5	4.7 ±10%	130 (AS)	-40 to 125	11.5	4.5	16.5	5.0	0.6

Maximum Current shows typical capacities of the transformer which can be used.

These series are recognized by UL.

Taping type is also available. (PTGL\_A0 series)

■ Protective Threshold Current Range (30V Series)

PTGL4SAS100K2N51B0

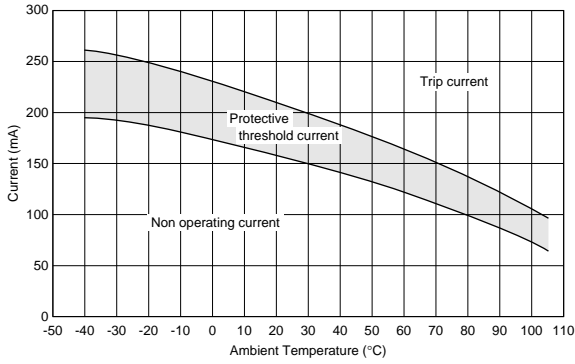

PTGL4SAS100K2B51B0

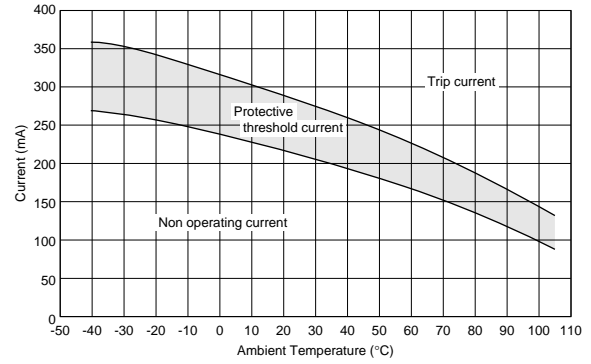

PTGL5SAS3R9K2B51B0

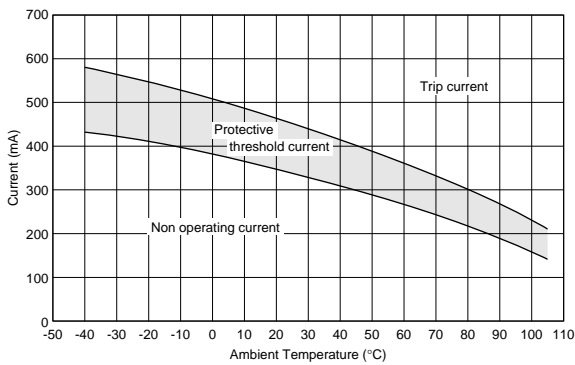

PTGL7SAS2R7K2B51B0

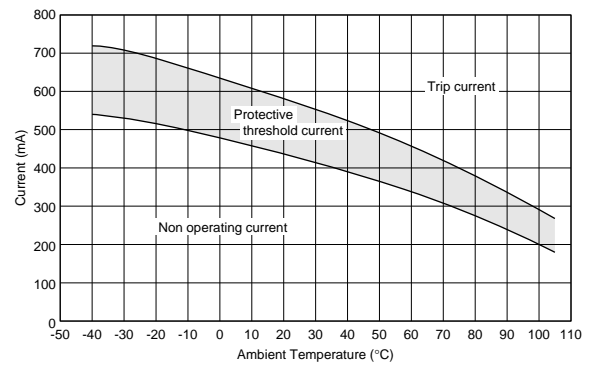

PTGL7SAS1R8K2B51B0

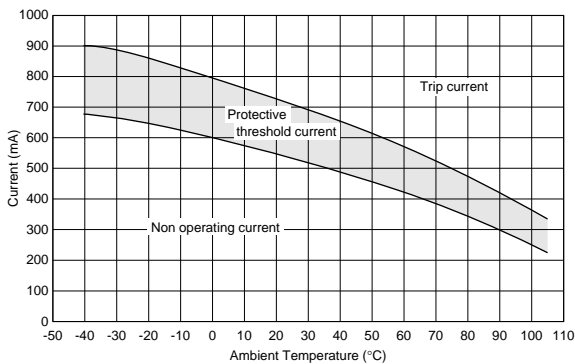

PTGL9SAS1R2K2B51B0

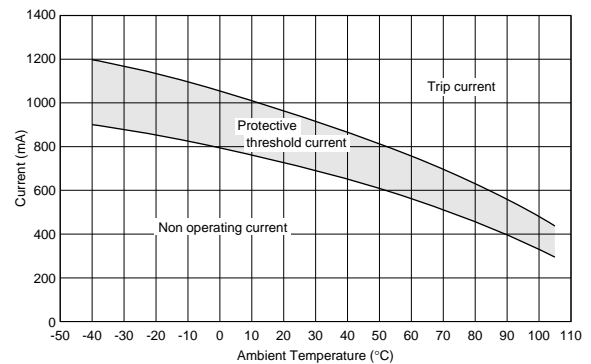

7

■ Protective Threshold Current Range (51V Series)

PTGLCSAS0R8K2B51B0

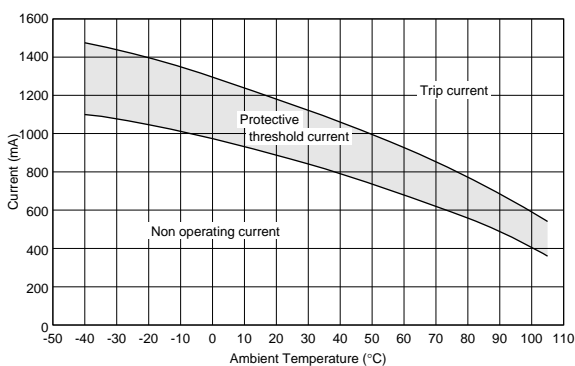

PTGL4SAS100K3B51B0

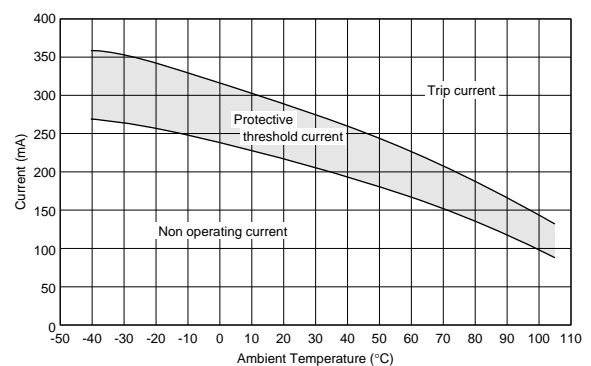

Continued on the following page.

↳ Continued from the preceding page.

■ Protective Threshold Current Range (51V Series)

PTGL5SAS6R8K3B51B0

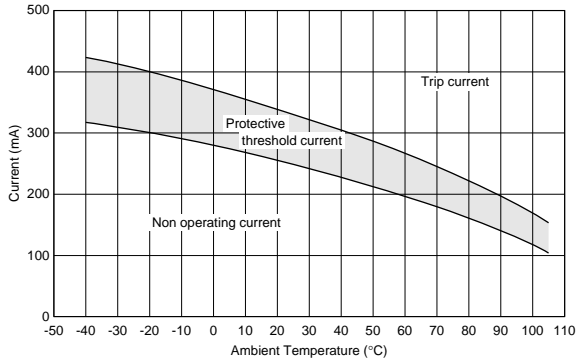

PTGL7SAS3R3K3B51B0

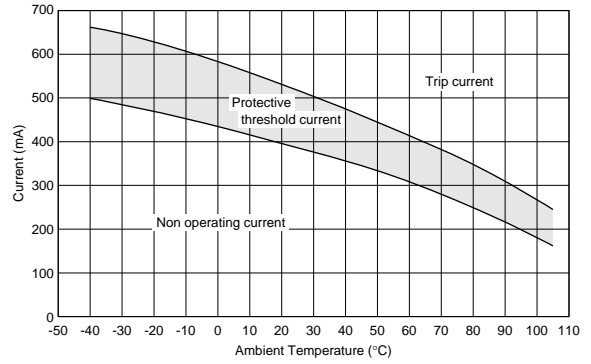

PTGL9SAS2R2K3B51B0

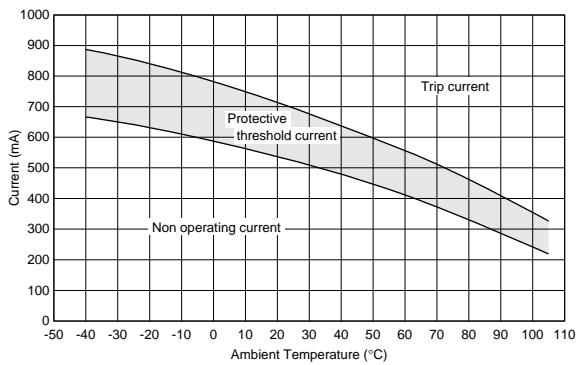

PTGLCSAS1R2K3B51B0

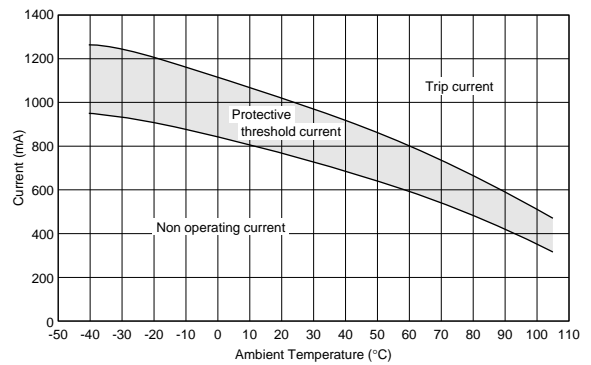

■ Protective Threshold Current Range (60V Series)

PTGL4SAS220K4N51B0

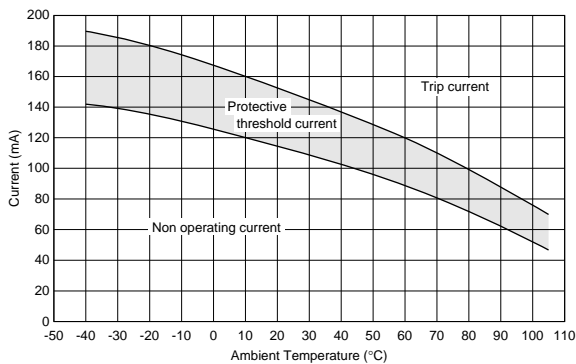

PTGL4SAS220K4B51B0

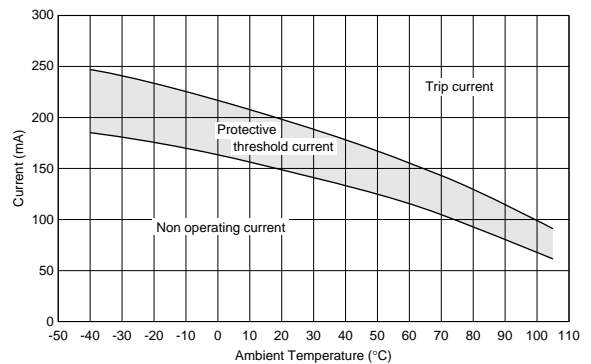

PTGL5SAS100K4B51B0

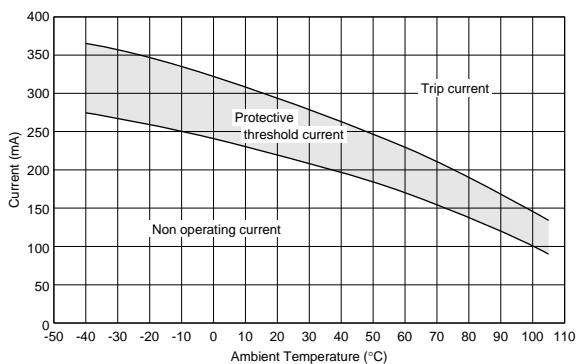

PTGL7SAS5R6K4N51B0

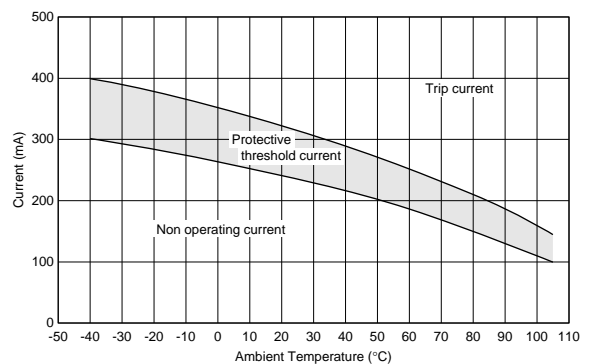

7

Continued on the following page. ↗

↳ Continued from the preceding page.

■ Protective Threshold Current Range (60V Series)

PTGL7SAS5R6K4B51B0

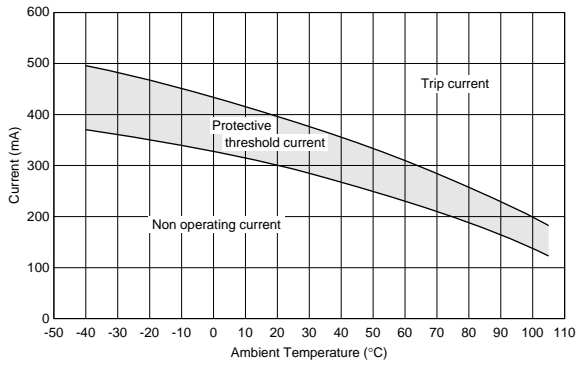

PTGL9SAS3R3K4B51B0

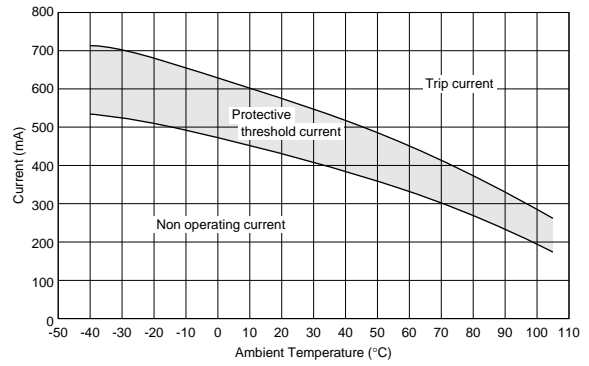

■ Protective Threshold Current Range (140V Series)

PTGLCSAS2R2K4B51B0

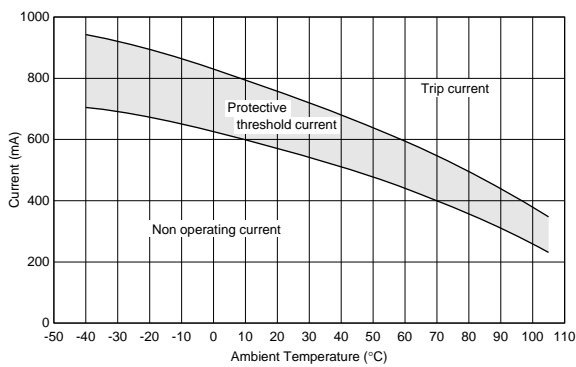

PTGL4SAS560K6B51B0

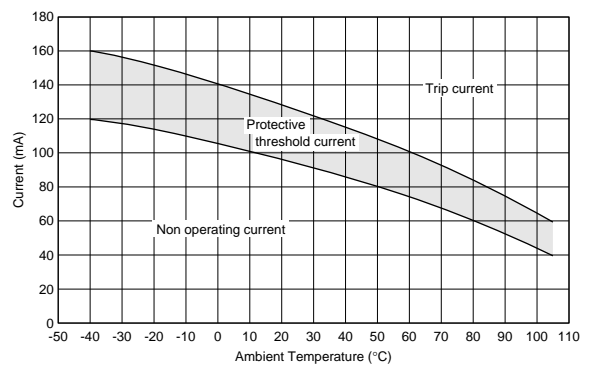

PTGL5SAS270K6B51B0

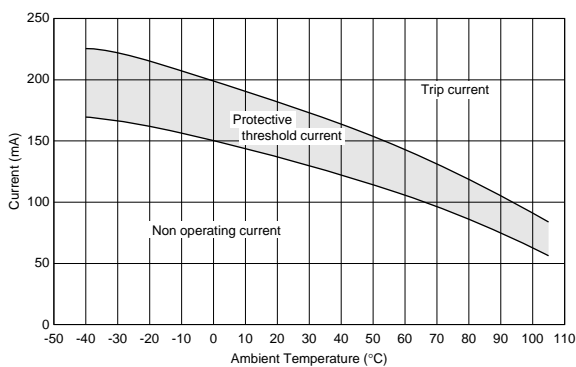

PTGL7SAS150K6B51B0

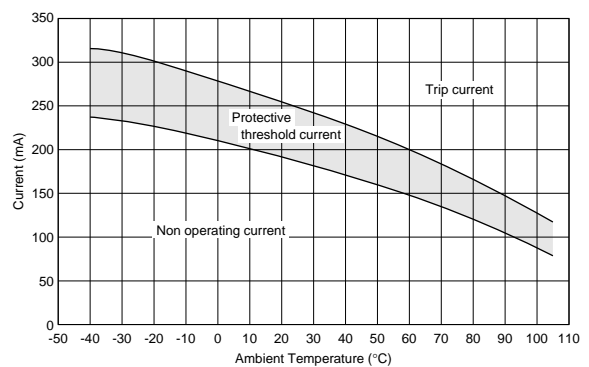

PTGL9SAS120K6B51B0

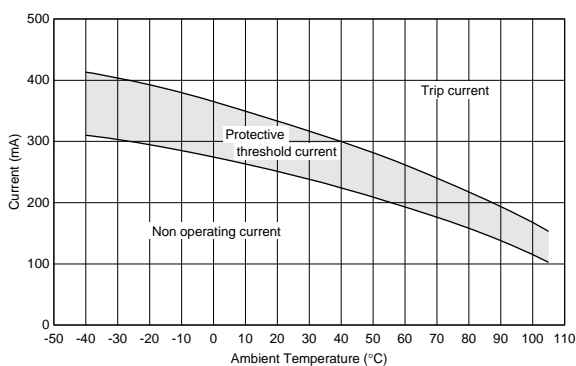

PTGL9SAS7R6K6B51B0

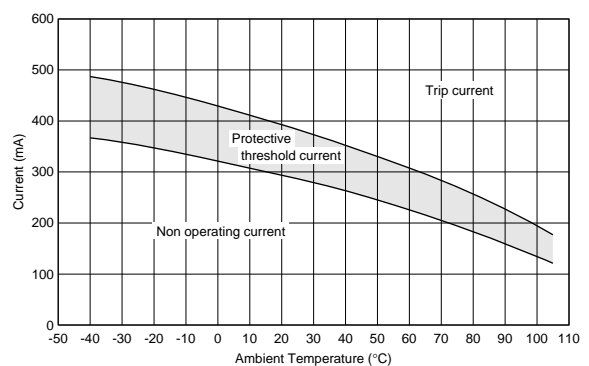

7

Continued on the following page. ↗

Continued from the preceding page.

■ Protective Threshold Current Range (140V Series)

PTGLCSAS4R7K6B51B0

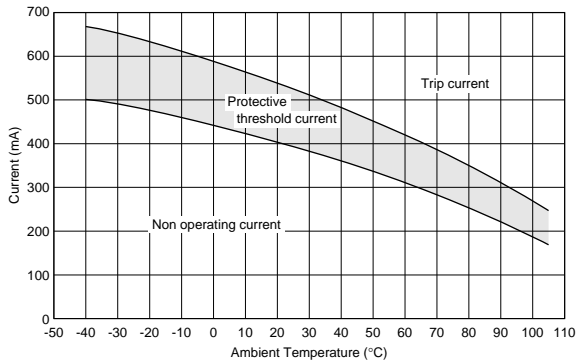

■ Operating Time (Typical Curve) (30V Series)

PTGL4SAS100K2N51B0

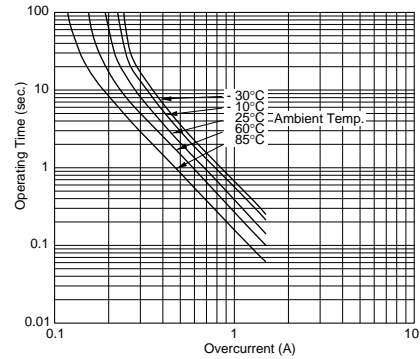

PTGL4SAS100K2B51B0

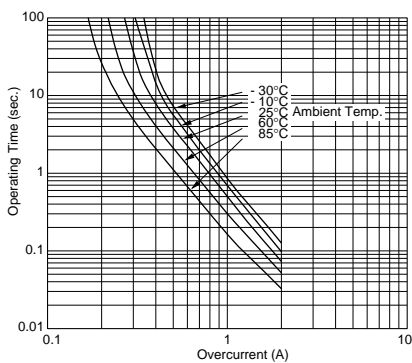

PTGL5SAS3R9K2B51B0

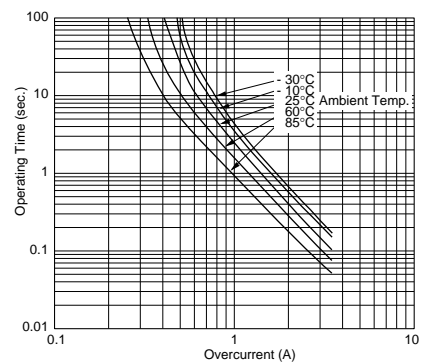

PTGL7SAS2R7K2B51B0

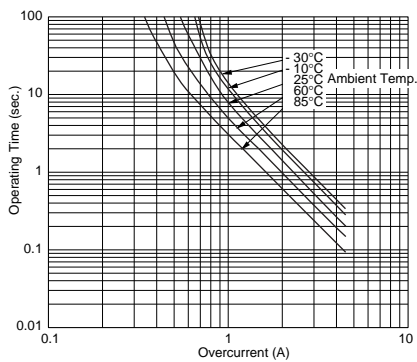

PTGL7SAS1R8K2B51B0

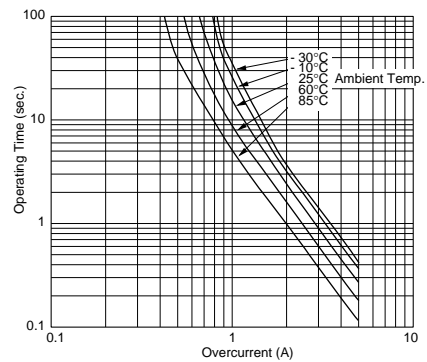

PTGL9SAS1R2K2B51B0

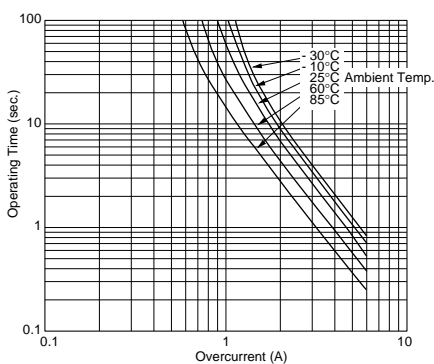

PTGLCSAS0R8K2B51B0

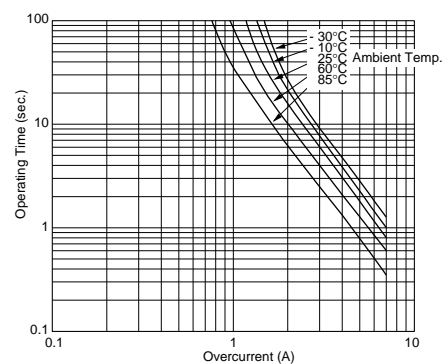

Continued from the preceding page.

■ Operating Time (Typical Curve) (51V Series)

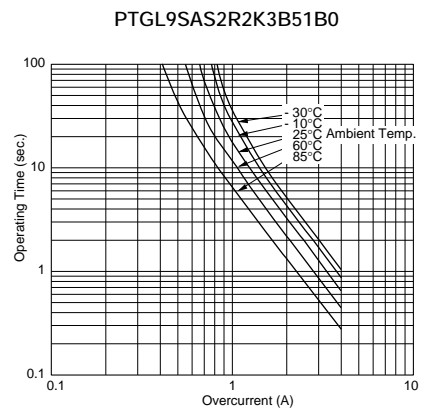
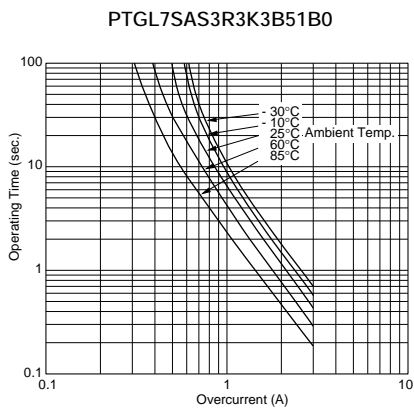
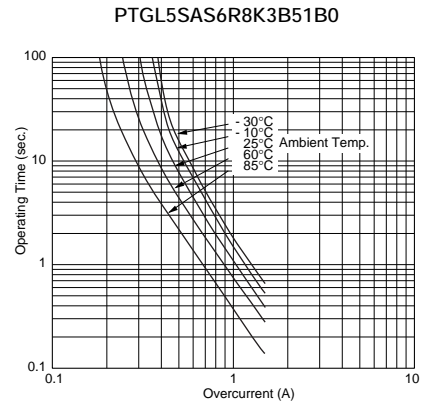
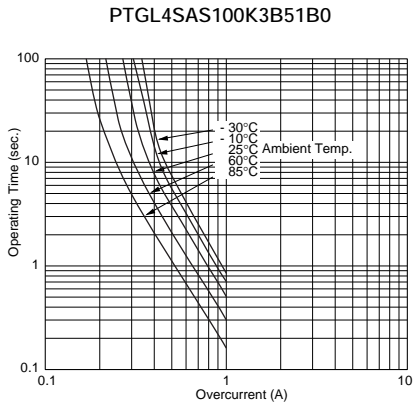

■ Operating Time (Typical Curve) (60V Series)

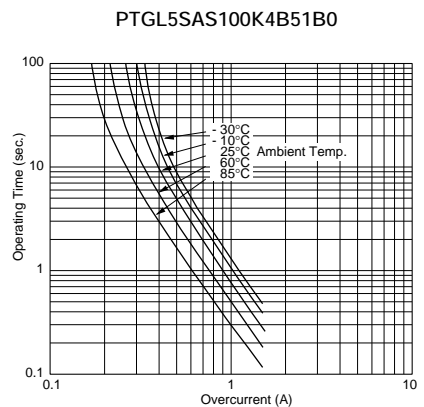
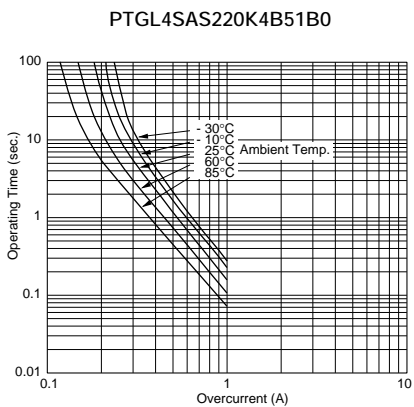
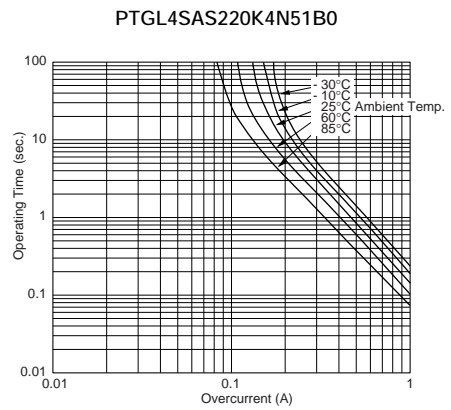
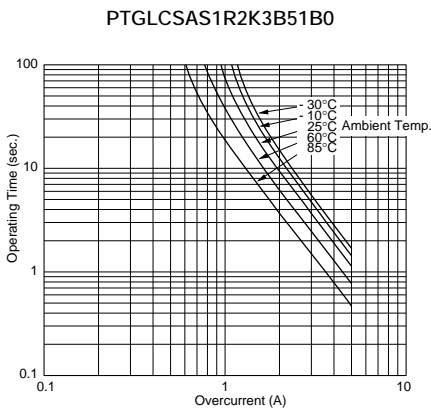

7

Continued on the following page. ↗

Continued from the preceding page.

■ Operating Time (Typical Curve) (60V Series)

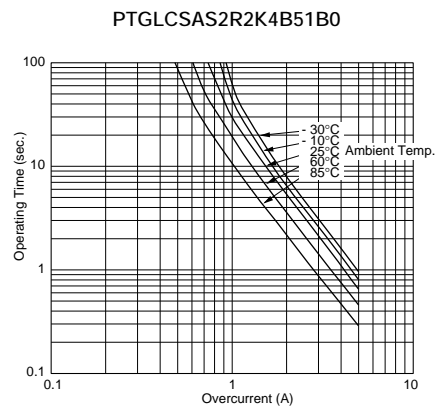
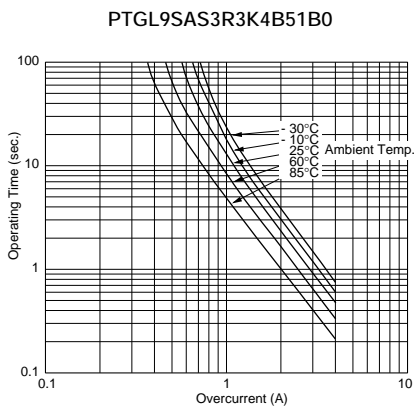
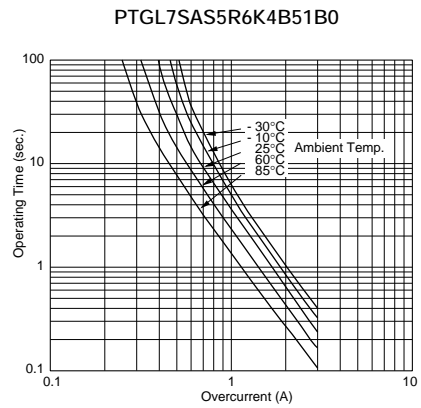
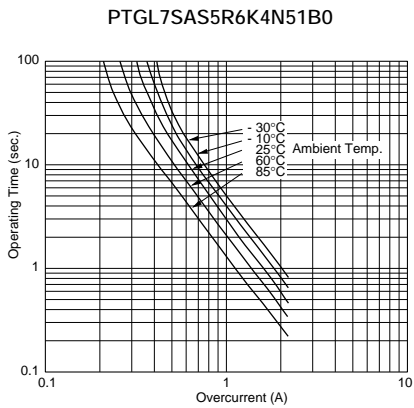

■ Operating Time (Typical Curve) (140V Series)

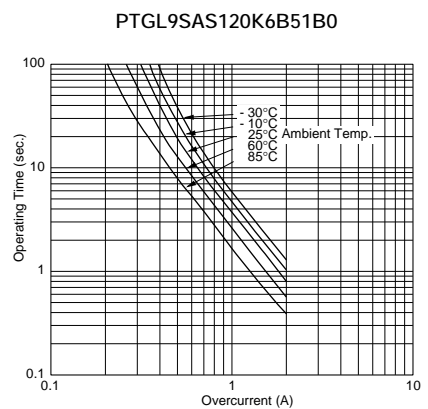
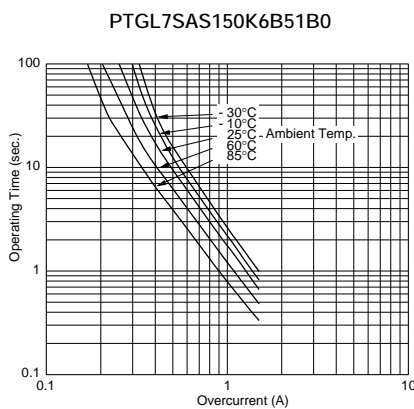
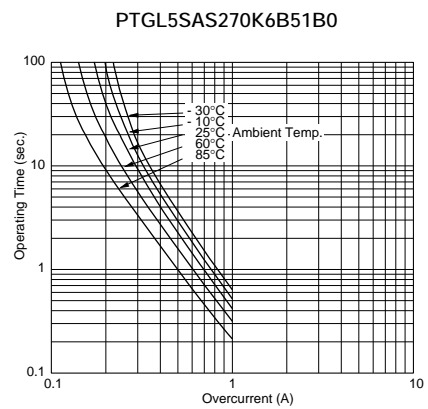
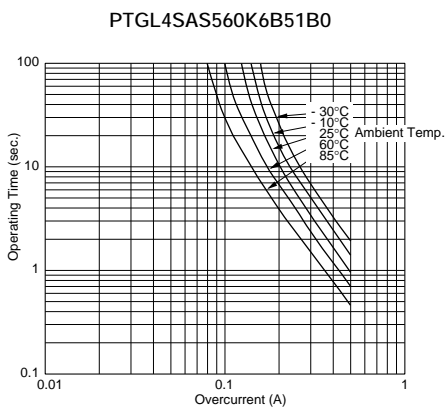

7

Continued on the following page. ↗

↳ Continued from the preceding page.

### ■ Operating Time (Typical Curve) (140V Series)

PTGL9SAS7R6K6B51B0

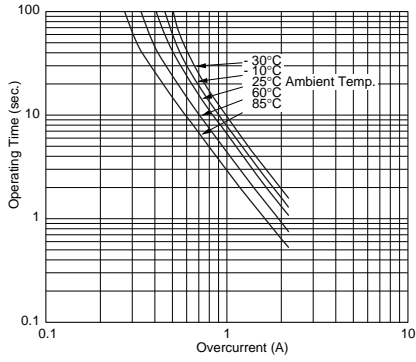

PTGLCSAS4R7K6B51B0

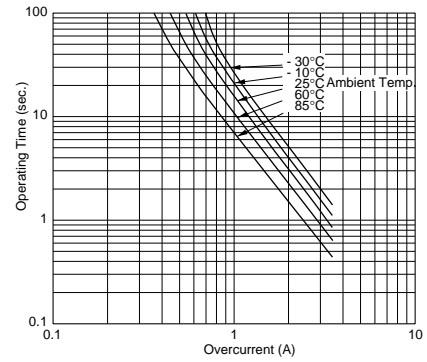



## POSISTOR® Lead Type for Overheat Protection Specifications and Test Methods

No.	Item	Rating Value	Method of Examination
1	Operating Temperature 1	-30 to +125°C	The temperature range with maximum voltage applied to the POSISTOR®.
2	Operating Temperature 2	-40 to +125°C	The temperature range with following voltage applied to the POSISTOR®. <applied voltage> 30V and 51V series: max. 16V, 60V series: max. 30V, 140V series: max. 140V
3	Resistance (R25)	Satisfies ratings	Resistance value is measured by applying voltage under 1.0Vdc (by a direct current of less than 10mA) at 25°C. (But it must be measured after it is applied maximum voltage for 180 seconds and then is left for 2 hours at 25°C.)
4	Withstanding Voltage	No problem	We apply AC voltage 120% that of the maximum voltage to POSISTOR® by rising voltage gradually for 180±5 seconds at 25°C. (A protective resistor is to be connected in series, and the inrush current through POSISTOR® must be limited below max. rated value.)
5	Protective Threshold Current	Satisfies ratings (Trip Current, Non-operating Current)	Maximum current measured in this examination. Voltage is applied to POSISTOR® in 3 minutes step by step on still air based on "Protective Threshold Current Test Conditions" shown in next page. Stablecurrent is measured at each step.
6	Tensile Strength of Lead Wire Terminal	No damage	The load is gradually applied to each terminal of POSISTOR® until the force of 4.9N in the axial direction with fixing POSISTOR®'s body itself and this load is being kept for 10 seconds.
7	Bending Strength of Lead Wire Terminal	Lead wire does not come off	POSISTOR® is held so that it is perpendicular to the lead wire with 2.45N in the axial direction of the lead wire. The lead wire is slowly bent toward 90° and returned. Then it is slowly bent in the opposite direction and returned to original state.
8	Solderability	Solder is applied around the lead wire covering 3/4 or more of the circumference without gap in the axial direction.	The Lead wire of POSISTOR® is soaked in a Isopropyl Alcohol (JIS K 8839) solution (about 25wt%) of colophony (JIS K 5902) for 5-10 sec. And, each lead wire is soaked in Molten solder (JIS Z 3282 H60A) at 235±5°C from the bottom to a point of 2.0-2.5mm for 2±0.5 sec.
9	Terminal Durability of Soldering	$\Delta R/R25 \leq \pm 15\%$	The lead wire of POSISTOR® is soaked in Molten solder (JIS Z 3282 H60A) at 350±10°C from the bottom to a point of 2.0-2.5mm for 3.5±0.5 sec. After the device is left at room temperature (25°C) for 24±4 hours, the resistance is measured.
10	Vibration Resistant	$\Delta R/R25 \leq \pm 20\%$	Acceleration: 98m/s <sup>2</sup> (10G) Width: 1.5mm Vibration: 10-500-10Hz Vibrate for 11 minutes X 24 cycles in each of 3 mutually perpendicular planes for a total of 13.5 hours.
11	Heat Resistant	$\Delta R/R25 \leq \pm 20\%$	POSISTOR® is set in an environmental chamber at 125±3°C for 1000 hours. After the device is left at room temperature (25°C) for one hour, the resistance measurement is performed.
12	Cold Resistant	$\Delta R/R25 \leq \pm 20\%$	POSISTOR® is set in an environmental chamber at -40±3°C for 1000 hours. After the device is left at room temperature (25°C) for one hour, the resistance measurement is performed.
13	Resistance to Damp Heat	$\Delta R/R25 \leq \pm 20\%$	POSISTOR® is set in an environmental chamber at 85±3°C and 80-85% humidity for 1000±12 hours. After the device is left at room temperature (25°C) for one hour, the resistance measurement is performed.

Continued on the following page. 

## POSISTOR<sup>®</sup> Lead Type for Overheat Protection Specifications and Test Methods

☑ Continued from the preceding page.

### ■ Operating current test conditions

#### (1) Substrate

Materials: Phenol

Size: 50x50x1.6mm

Land Pattern: Cu land without through hole

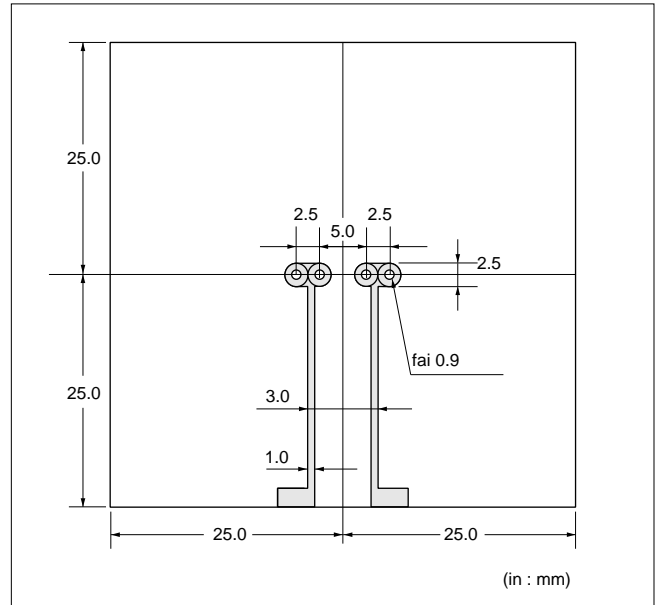

#### (2) Measurement condition

Solder POSISTOR<sup>®</sup> on the substrate, then put the cover (150mm cubed) surround POSISTOR<sup>®</sup> to prevent flow of wind.

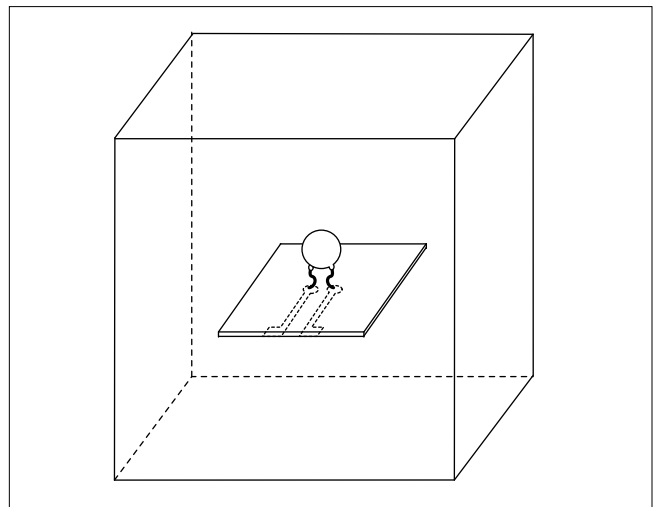

#### (3) Measurement circuit

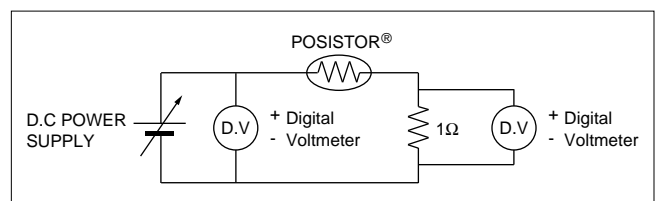

## POSISTOR® Lead Type for Overheat Protection ⚠Caution/Notice

### ■ ⚠Caution (Storage and Operating Condition)

This product is designed for application in an ordinary environment (normal room temperature, humidity and atmospheric pressure). Do not use under the following conditions because all these factors can deteriorate the characteristics or cause product failure and burn-out.

1. Corrosive gas or deoxidizing gas (Chlorine gas, Hydrogen sulfide gas, Ammonia gas, Sulfuric acid gas, Nitric oxide gas, etc.)
2. Volatile or flammable gas
3. Dusty conditions
4. Under vacuum, or under high or low-pressure
5. Wet or humid conditions
6. Places with salt water, oils, chemical liquids or organic solvents
7. Strong vibrations
8. Other places where similar hazardous conditions exist

### ■ ⚠Caution (Other)

Be sure to provide an appropriate fail-safe function on your product to prevent secondary damage that may be caused by the abnormal function or the failure of our product.

### ■ Notice (Storage and Operating Condition)

To keep solderability of product from declining, following storage condition is recommended.

1. Storage condition:
  - Temperature -10 to +40 degree C
  - Humidity less than 75%RH (not dewing condition)
2. Storage term:
  - Use this product within 6 months after delivery by first-in and first-out stocking system.
3. Handling after unpacking:
  - After unpacking, promptly reseal this product or store it in a sealed container with a drying agent.
4. Storage place:
  - Do not store this product in corrosive gas (sulfuric acid, chlorine, etc.) or in direct sunlight.

### ■ Notice (Soldering and Mounting)

When the lead of this product is soldered, pay attention as follows to avoid the decline of element characteristics or break-down of the element.

1. Use Rosin type flux or non-activated flux
2. Do not dip the body into flux.  
(Flux should be coated to lead wire only for soldering.)
3. Be sure that preheating does not melt the soldering of this product.

### ■ Notice (Handling)

1. Do not apply an excessive force to the lead.  
Otherwise, it may cause the junction between lead and element to break, or may crack the element. Therefore, holding the element side lead wire is recommended when lead wire is bent or cut.
2. This product does not have waterproof construction. Splashed water may cause failure mode such as decline of characteristics or current leak.
3. When this product is operated, temperature of some area may be over 100 to 160 degree C. Be sure that surrounding parts and inserting material can withstand the temperature. If the surrounding part and material are kept under such condition, they may deteriorate or produce harmful gas (Chlorine gas, Hydrogen sulfide gas, Ammonia gas, Sulfuric acid gas, Nitric oxide gas, etc.). And such harmful gas may deteriorate the element.

## for NTC Thermistors Chip Type Package

### ■ Minimum Quantity Guide

Part Number	Quantity (pcs.)	
	Paper Tape	Plastic Tape
<b>NCP15</b>	10000	-
<b>NCP18</b>	4000	-
<b>NCM21</b>	-	4000

### ■ Tape Carrier Packaging

#### 1. Dimensions of Reel

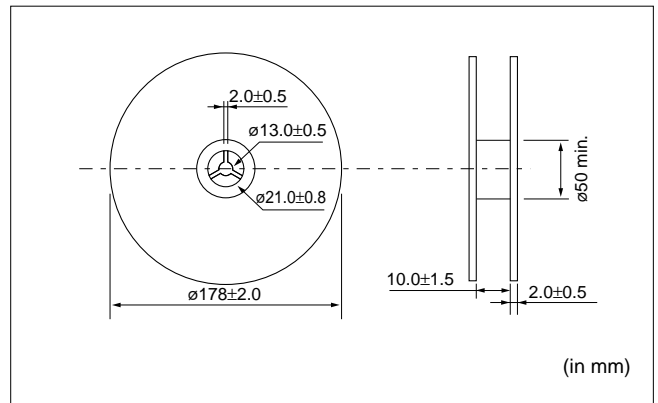

#### 2. Taping Method

- (1) A tape in a reel contains Leader unit and Trailer unit where products are not packed. (Please refer to the figure at right.)
- (2) The top and base tapes or, plastic and cover tape are not stuck at the first five pitches minimum.
- (3) A label shall be attached on the reel. (MURATA's part number, inspection number and quantity should be marked on the label.)
- (4) Taping reels are packed in a package.

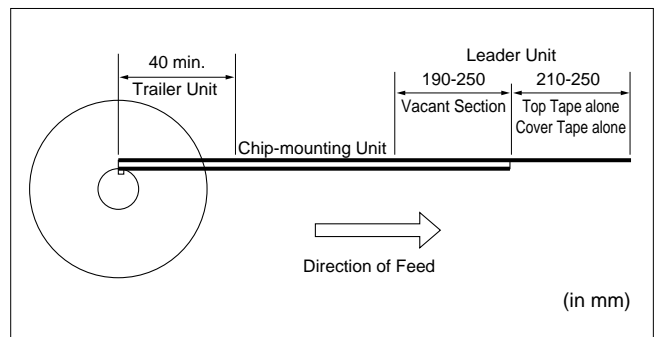

Continued on the following page.

## for NTC Thermistors Chip Type Package

☐ Continued from the preceding page.

### 3. Paper Tape (NCP15/18 Series)

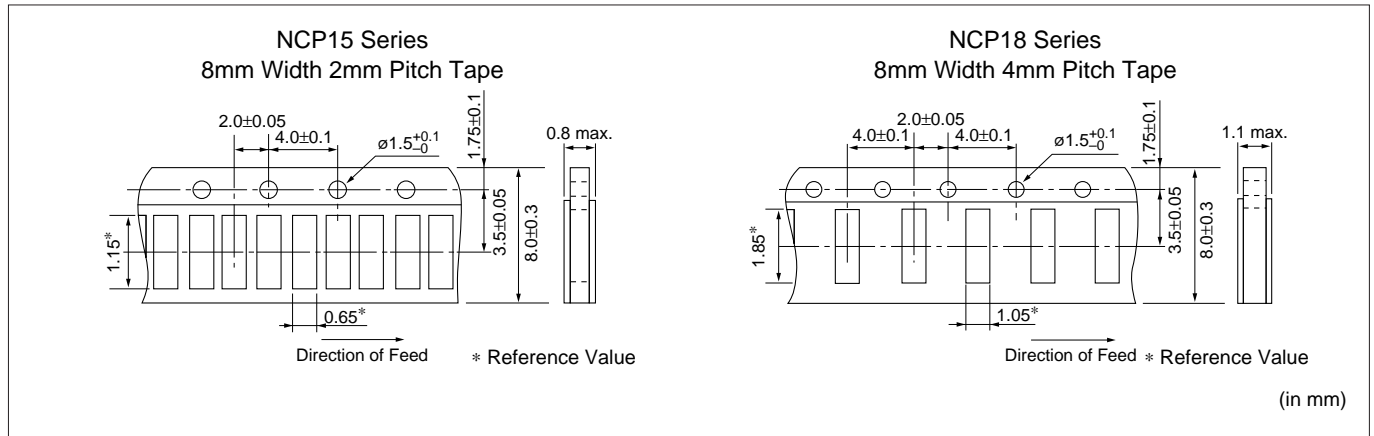

#### (1) Other Conditions

##### ① Packaging

Products are packaged in the cavity of the base tape and sealed by top tape and bottom tape.

##### ② Tape

Top tape and bottom tape have no joints and products are packaged and sealed in the cavity of the base tape, continuously.

#### (2) Peeling Force of Top Tape

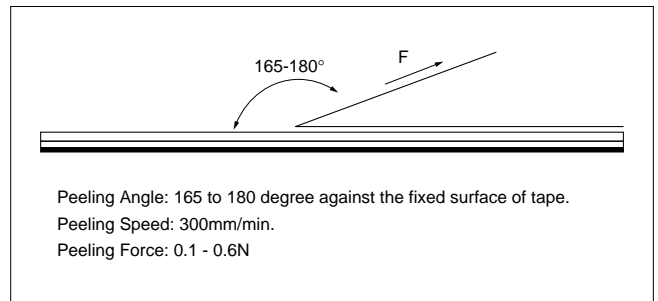

#### (3) Pull Strength

Pull strength of top tape is specified at 10N minimum.

Pull strength of bottom tape shall be specified 5N minimum.

Continued on the following page. ☐

## for NTC Thermistors Chip Type Package

☐ Continued from the preceding page.

### 4. Plastic Tape (NCM21 Series)

#### (1) Other Conditions

##### ① Packaging

Products are packaged in the each embossed cavity of plastic tape and sealed by cover tape.

##### ② Tape

Cover tape has no joints.

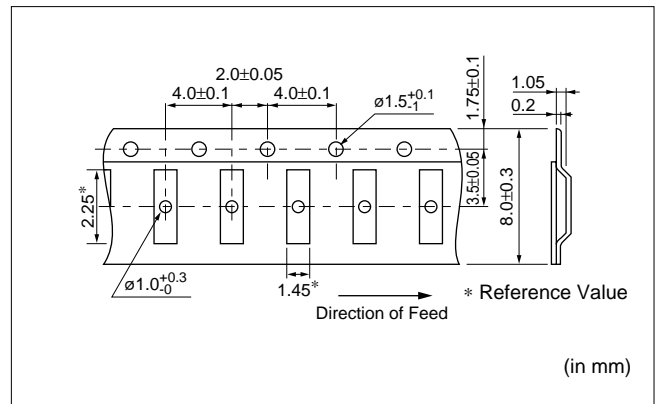

#### (2) Peeling Force of Cover Tape

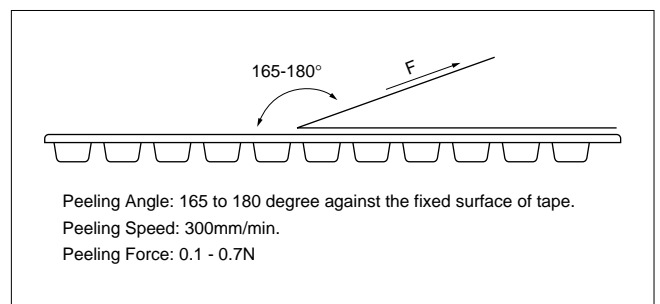

#### (3) Tape Strength

Pull strength of plastic tape and cover tape shall be specified 10N minimum.

## for NTC Thermistors Lead Type Package

### ■ Minimum Quantity Guide

Part Number	Minimum Quantity (pcs.)	
	Taping (Ammo Pack)	Bulk
NTSS	3000	100

### ■ Taping Dimension (NTSS\_N6A0 Series)

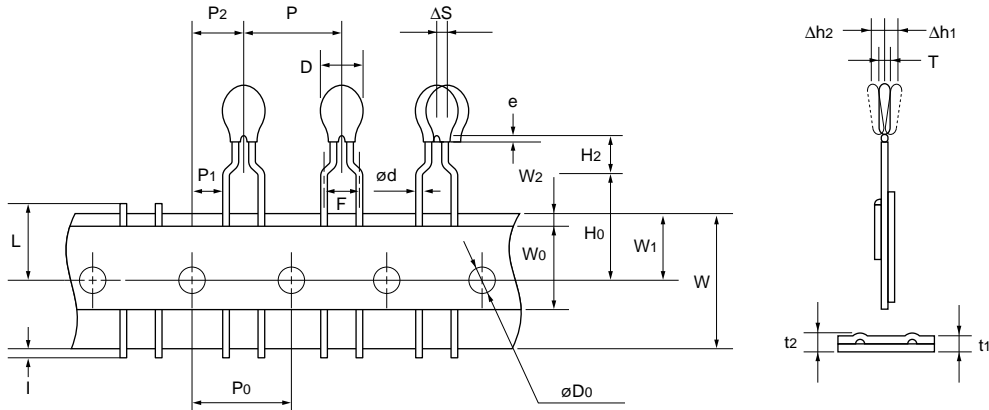

Item	Code	Dimension (mm)
Pitch of Component	P	12.7
Pitch of Sprocket Hole	P0	12.7±0.3
Lead Spacing	F	5.0+0.8/-0.2
Lead Length from Hole Center to Component Center	P2	6.35±1.3
Lead Length from Hole Center to Lead	P1	3.85±0.8
Body Diameter	D	3.5 max.
Deviation along Tape, Left or Right	ΔS	0±2.0
Carrier Tape Width	W	18.0±0.5
Position of Sprocket Hole	W1	9.0±0.5
Lead Distance between Reference and Bottom Planes	H0	16.0±1.0
Height of Component	H2	4.0 max.
Overflow of Lead	l	+0.5 to -1.0
Diameter of Sprocket Hole	D0	4.0±0.1
Lead Diameter	d	0.50±0.03
Total Tape Thickness	t1	0.6±0.3
Total Thickness, Tape and Lead Wire	t2	1.6 max.
Deviation across Tape	Δh1, Δh2	1.0 max.
Portion to Cut in Case of Defect	L	11.0+0/-2.0
Hole Down Tape Width	W0	11.0 min.
Hole Down Tape Position	W2	1.5±1.5
Coating Extension on Lead	e	Up to the crimp point
Thickness	T	2.6 max.

(in mm)

## for POSISTOR<sup>®</sup> Chip Type Package

### ■ Minimum Quantity Guide

Part Number	Quantity (pcs.)	
	Paper Tape	Plastic Tape
PR*18_RB	4000	-
PR*21_RA	-	4000
PR*21_RK	-	3000

### ■ Tape Dimensions

PR\*18\_RB Series: Paper Tape

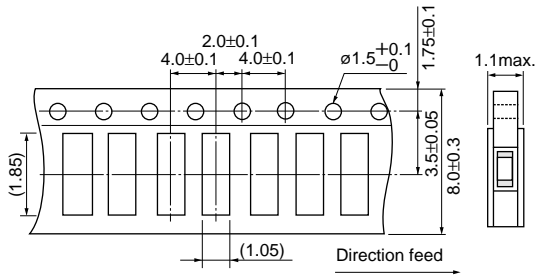

PR\*21\_RA Series: Plastic Tape

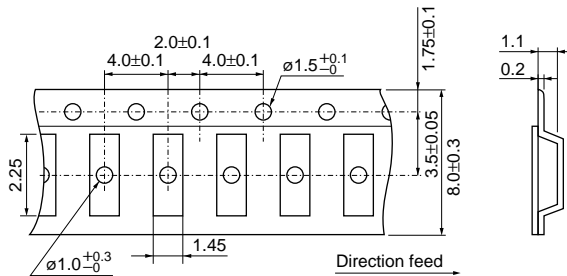

PR\*21\_RK Series: Plastic Tape

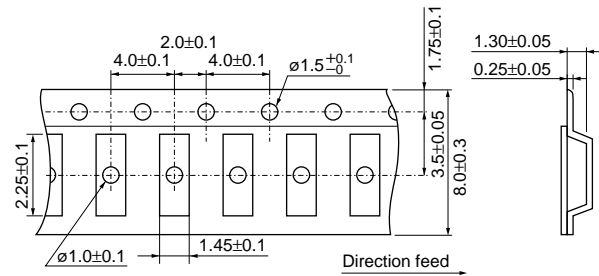

### ■ Reel Dimensions

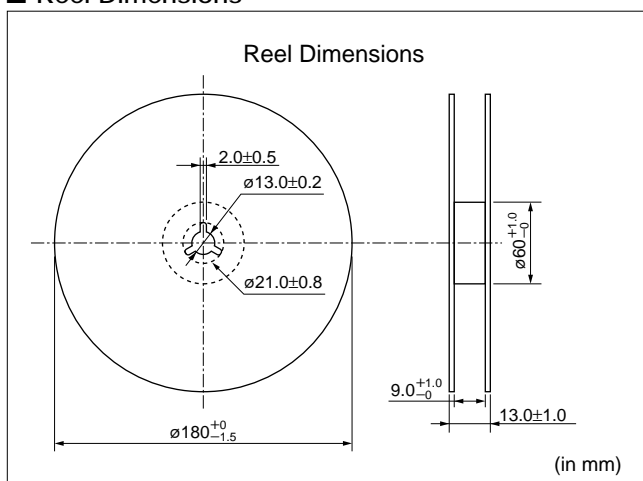



## for POSISTOR<sup>®</sup> Lead Type Package

### ■ Minimum Quantity Guide

Part Number	Minimum Quantity (pcs.)	
	Taping (Ammo Pack)	Bulk
PTGL	1500	100

### ■ Taping Dimension (PTGL\_A0 Series)

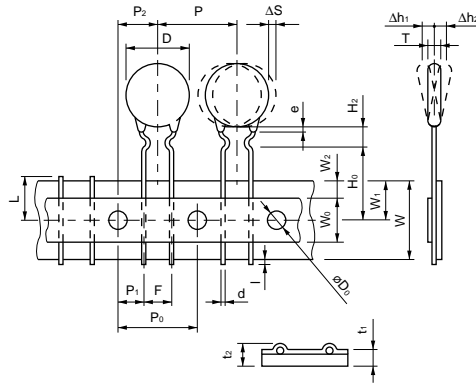

Item	Code	Dimensions (mm)	Note
Pitch of Component	P	12.7	Tolerance is determined by $\Delta S$ .
Pitch of Sprocket Hole	P <sub>0</sub>	12.7±0.3	
Lead Spacing	F	5.0 <sup>+0.8</sup> <sub>-0.3</sub>	
Length from Hole Center to Lead	P <sub>1</sub>	3.85±0.8	
Length from Hole Center to Component	P <sub>2</sub>	6.35±1.3	Deviation in the feeding direction
Body Diameter	D	Please see in Ratings	
Thickness	T	Please see in Ratings	
Deviation along Tape, Left or Right	$\Delta S$	±1.5	Including the inclination caused by lead bending.
Carrier Tape Width	W	18.0±0.5	
Position of Sprocket Hole	W <sub>1</sub>	9.0 <sup>+0.5</sup> <sub>-0.75</sub>	Deviation of tape width.
Lead Distance between Reference and Bottom Planes	H <sub>0</sub>	16.0±1.0	
	H <sub>2</sub>	6.0 max.	
Overflow of Lead	l	+0.5 — -1.0	
Diameter of Sprocket Hole	D <sub>0</sub>	4.0±0.2	
Lead Diameter	d	Please see in Ratings	
Total Tape Thickness	t <sub>1</sub>	0.6±0.3	
	t <sub>2</sub>	2.0 max.	
Deviation across Tape	$\Delta h_1, \Delta h_2$	1.5 max.	
Portion to cut in Case of Defect	L	11.0 <sup>+0</sup> <sub>-2.0</sub>	
Hold Down Tape Width	W <sub>0</sub>	11.0 min.	
Hold Down Tape Position	W <sub>2</sub>	4.0 max.	
Coating Extension on Lead	e	Up to the center of crimp	

**⚠Note:**

1. Export Control

⟨For customers outside Japan⟩

Murata products should not be used or sold for use in the development, production, stockpiling or utilization of any conventional weapons or mass-destructive weapons (nuclear weapons, chemical or biological weapons, or missiles), or any other weapons.

⟨For customers in Japan⟩

For products which are controlled items subject to the "Foreign Exchange and Foreign Trade Law" of Japan, the export license specified by the law is required for export.

2. Please contact our sales representatives or product engineers before using the products in this catalog for the applications listed below, which require especially high reliability for the prevention of defects which might directly damage to a third party's life, body or property, or when one of our products is intended for use in applications other than those specified in this catalog.

- |                             |   |
|-----------------------------|---|
| ① Aircraft equipment        | ② Aerospace equipment   |
| ③ Undersea equipment        | ④ Power plant equipment   |
| ⑤ Medical equipment         | ⑥ Transportation equipment (vehicles, trains, ships, etc.)  |
| ⑦ Traffic signal equipment  | ⑧ Disaster prevention / crime prevention equipment  |
| ⑨ Data-processing equipment | ⑩ Application of similar complexity and/or reliability requirements to the applications listed in the above |

3. Product specifications in this catalog are as of November 2004. They are subject to change or our products in it may be discontinued without advance notice. Please check with our sales representatives or product engineers before ordering. If there are any questions, please contact our sales representatives or product engineers.

4. Please read rating and ⚠CAUTION (for storage, operating, rating, soldering, mounting and handling) in this catalog to prevent smoking and/or burning, etc.

5. This catalog has only typical specifications because there is no space for detailed specifications. Therefore, please approve our product specifications or transact the approval sheet for product specifications before ordering.

6. Please note that unless otherwise specified, we shall assume no responsibility whatsoever for any conflict or dispute that may occur in connection with the effect of our and/or a third party's intellectual property rights and other related rights in consideration of your use of our products and/or information described or contained in our catalogs. In this connection, no representation shall be made to the effect that any third parties are authorized to use the rights mentioned above under licenses without our consent.

7. No ozone depleting substances (ODS) under the Montreal Protocol are used in our manufacturing process.