

SCR

2N877-81

2N885-89

FEATURES:

- All-diffused for Proved Reliability
- Miniature Package TO-18
- Two Ranges of Gate Sensitivity:
2N877-881 — 200 μ a max.
2N885-889 — 20 μ a max.
- Low Holding Current:
2N877-881 — 5 ma. max.
2N885-889 — 3 ma. mas.
- Voltage Ratings up to 200 volts
- Designed for Military Applications

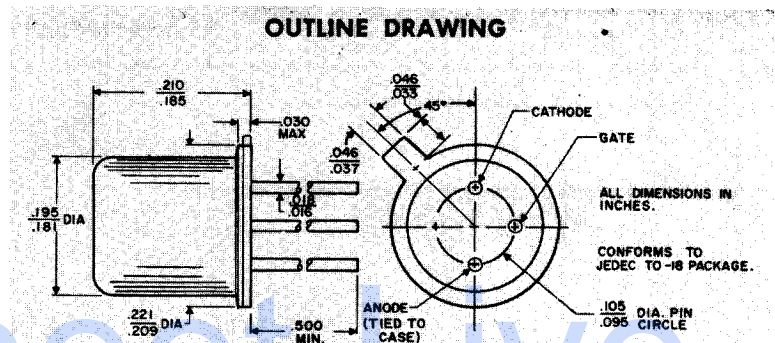
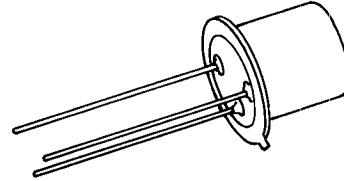

MAXIMUM ALLOWABLE RATINGS

TYPES	PEAK FORWARD BLOCKING VOLTAGE, V_{FBM} , $T_J = -65^\circ\text{C to } +125^\circ\text{C}$. $R_{GK} = 1000 \text{ OHMS MAXIMUM}$.	WORKING AND REPETITIVE PEAK REVERSE VOLTAGE, $V_{ROM} \text{ (wkg)}$ and $V_{ROM} \text{ (rep)}$. $T_J = -65^\circ\text{C to } +150^\circ\text{C}$	NON-REPETITIVE PEAK REVERSE VOLTAGE, $V_{ROM} \text{ (non-rep)} < 5 \text{ Milliseconds}$. $T_J = -65^\circ\text{C to } +125^\circ\text{C}$
2N877, 2N885	30 volts	30 volts	45 volts
2N878, 2N886	60 volts	60 volts	90 volts
2N879, 2N887	100 volts	100 volts	130 volts
2N880, 2N888	150 volts	150 volts	200 volts
2N881, 2N889	200 volts	200 volts	275 volts

Peak Forward Voltage, PFV _____ 300 Volts
 RMS Forward Current, On-state _____ 0.5 Ampere
 Average Forward Current, On-state _____ Depends on conduction angle (see charts 2, 3, 11 & 12)
 Peak One Cycle Surge Forward Current (Non-repetitive), I_{FM} (surge) _____ 7 Amperes
 Peak Forward Gate Power Dissipation, P_{GM} _____ 0.1 Watt
 Average Forward Gate Power Dissipation, $P_{G(AV)}$ _____ 0.01 Watt
 Peak Gate Voltage, Forward and Reverse, V_{GFM} and V_{GRM} _____ 6 Volts
 Storage Temperature, T_{stg} _____ $-65^\circ\text{C to } +150^\circ\text{C}$
 Operating Temperature _____ $-65^\circ\text{C to } +150^\circ\text{C}$

CHARACTERISTICS

TEST	SYMBOL	MIN.	TYP.	MAX.	UNITS	TEST CONDITIONS	
FORWARD BLOCKING CURRENT 2N877-2N881	I_{FX}	—	0.03	10	$\mu\text{A dc}$	$V_{FX} = \text{Rated } V_{FXM}, R_{GK} = 1000 \text{ ohms}$	
		—	10	100		$T_J = +25^\circ\text{C}$	
		2N885-2N889	—	0.03		1	$T_J = +25^\circ\text{C}$
			—	10		20	$T_J = +125^\circ\text{C}$
REVERSE BLOCKING CURRENT 2N877-2N881	I_{RX}	—	0.1	10	$\mu\text{A dc}$	$V_{RX} = \text{Rated } V_{ROM} \text{ (rep)}$	
		—	10	100		$T_J = +25^\circ\text{C}$	
		2N885-2N889	—	0.1		1	$T_J = +125^\circ\text{C}$
			—	10		20	$T_J = +25^\circ\text{C}$
REVERSE GATE CURRENT	I_{GRM}	—	1	10	$\mu\text{A dc}$	$V_{GRM} = 2 \text{ Volts}, T_J = +25^\circ\text{C}$	
PEAK ON-VOLTAGE	V_{FM}	—	1.3	1.9	volts	$T_J = +25^\circ\text{C}, I_{FM} = 1 \text{ Ampere}$, single half sine wave pulse, 2.0 milliseconds wide max.	
HOLDING CURRENT 2N877-2N881	I_{HX}	0.4	1.7	5.0	mA dc	$T_J = +25^\circ\text{C}, R_{GK} = 1000 \text{ ohms}$, $V_{FX} = 24 \text{ Volts dc}$.	
		2N885-2N889	0.4	1.1			3.0
RATE OF RISE OF APPLIED FORWARD VOLTAGE	dv/dt	—	40	—	volts/ μsec	$T_J = +125^\circ\text{C}, R_{GK} = 1000 \text{ ohms}$, $V_{FXM} = \text{Rated } V_{FXM}$	
TURN-ON TIME (Delay Time + Rise Time)	$t_d + t_r$	—	1.0	—	μsec	$T_J = +25^\circ\text{C}, V_{FX} = \text{Rated } V_{FXM}$, $I_{FM} = 1 \text{ Ampere}$, Gate Supply: 6 Volts, 300 ohms	
CIRCUIT COMMUTATED TURN-OFF TIME All Types	t_{off}	—	15	—	μsec	$T_J = +125^\circ\text{C}, R_{GK} = 1000 \text{ ohms}$, $I_{FM} = 1 \text{ Ampere}, I_R \text{ (recovery)} = 1 \text{ Ampere}$ Reapplied $V_{FXM} = \text{Rated}$, Rate of Rise of Reapplied Forward Blocking Voltage = 20 V/ μsec	
GATE TRIGGER CURRENT 2N877-2N881	I_{GT}	—	40	200	$\mu\text{A dc}$	$V_{FX} = 6 \text{ Vdc}, R_{GK} = 1000 \text{ ohms}$, $R_L = 100 \text{ ohms maximum}$.	
		2N885-2N889	—	10		20	$T_J = +25^\circ\text{C}$
GATE TRIGGER VOLTAGE 2N877-2N881	V_{GT}	0.4	0.5	0.8	Vdc	$V_{FX} = 6 \text{ Vdc}, R_{GK} = 1000 \text{ ohms}$, $R_L = 100 \text{ ohms maximum}$.	
		2N885-2N889	0.44	0.5		0.6	$T_J = +25^\circ\text{C}$
		All Types	0.05	—		—	$V_{FX} = \text{Rated } V_{FXM}, R_{GK} = 1000 \text{ ohms}$, $T_J = +125^\circ\text{C}$

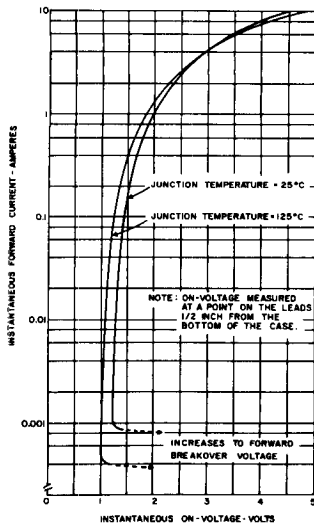

1. MAXIMUM FORWARD CHARACTERISTICS, ON-STATE

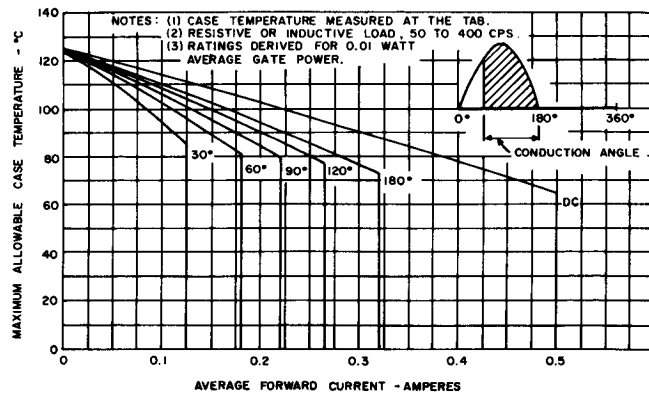

2. MAXIMUM ALLOWABLE CASE TEMPERATURE (125°C JUNCTION TEMP.)

2N877-81

2N885-89

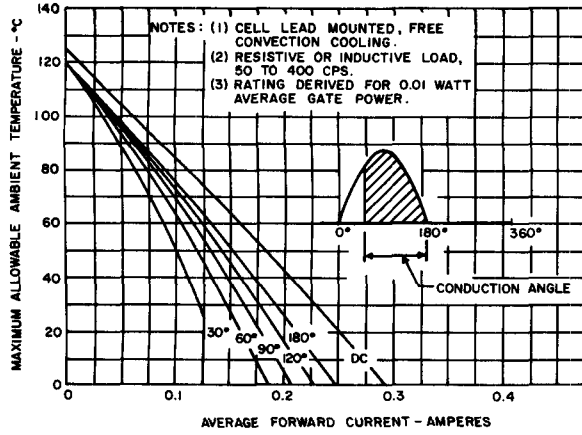

3. MAXIMUM ALLOWABLE AMBIENT TEMPERATURE (125°C JUNCTION TEMP.)

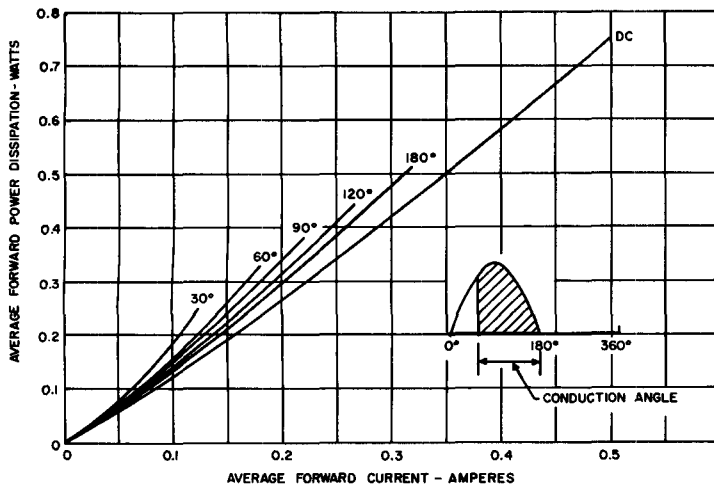

4. FORWARD POWER DISSIPATION

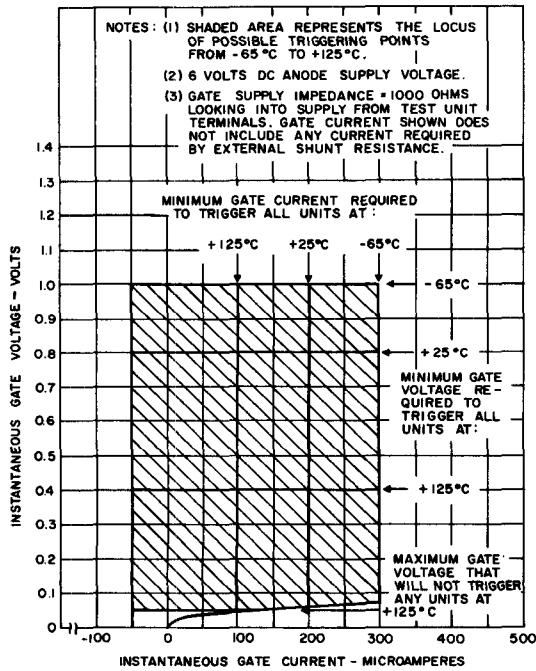

5. GATE TRIGGERING CHARACTERISTICS (2N877-2N881)

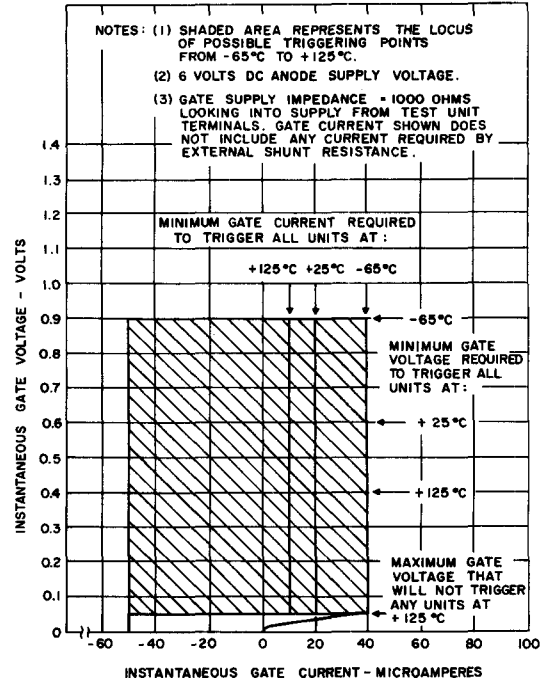

6. GATE TRIGGERING CHARACTERISTICS (2N885-2N889)

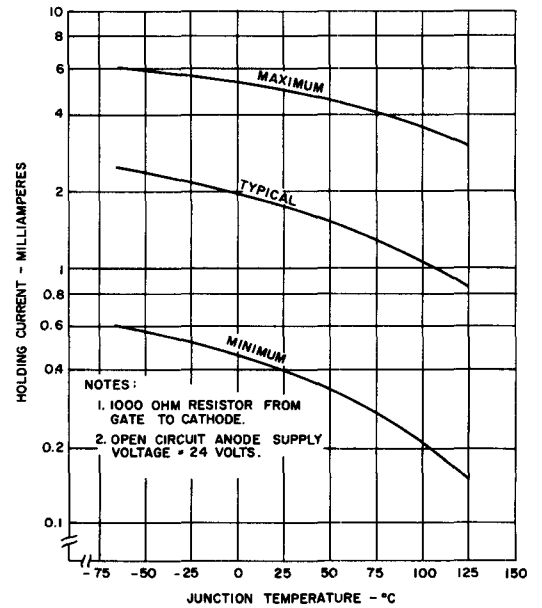

7. HOLDING CURRENT AS A FUNCTION OF JUNCTION TEMPERATURE (2N877-2N881)

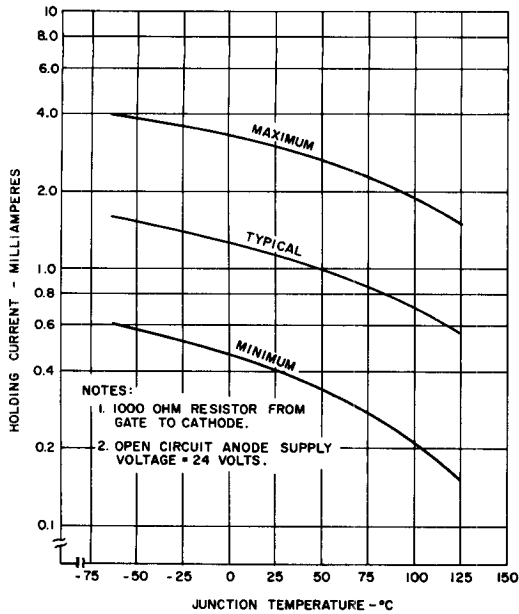

8. HOLDING CURRENT AS A FUNCTION OF JUNCTION TEMPERATURE (2N885-2N889)

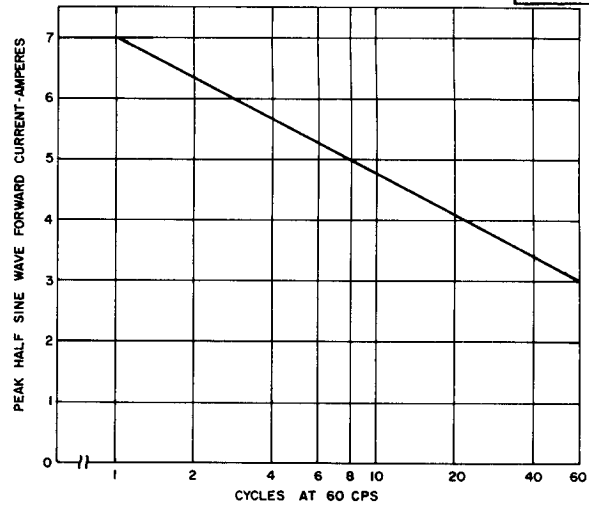

9. MAXIMUM ALLOWABLE NON-RECURRENT SURGE CURRENT AT RATED LOAD CONDITIONS

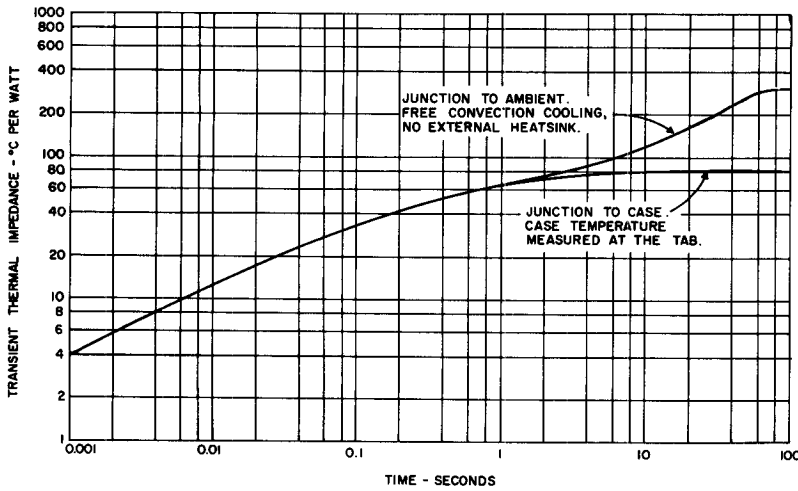

10. MAXIMUM TRANSIENT THERMAL IMPEDANCE

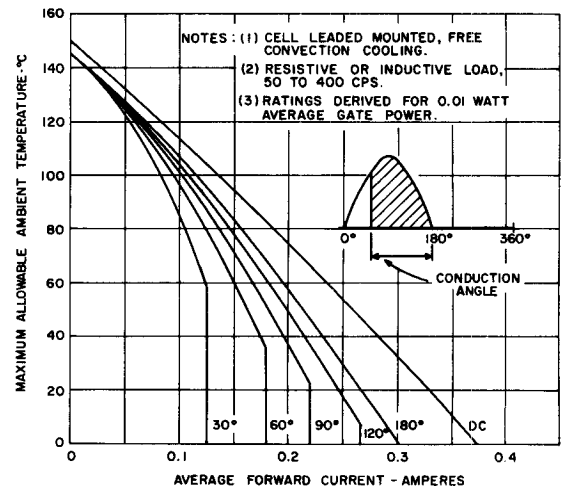

11. MAXIMUM ALLOWABLE AMBIENT TEMPERATURE (150°C JUNCTION TEMP.)

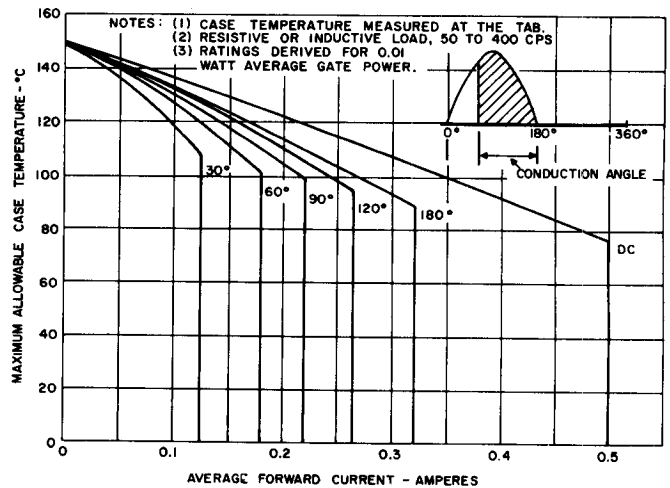

12. MAXIMUM ALLOWABLE CASE TEMPERATURE (150°C JUNCTION TEMP.)

Charts 11 and 12 apply to latching applications where SCR need not block forward voltage after being turned on, since the V_{FXM} rating does not apply above 125°C junction temperature. SCR will again block rated forward voltage after junction temperature drops below 125°C.