

# MUR180E, MUR1100E

MUR1100E is a Preferred Device

## SWITCHMODE™ Power Rectifiers

### Ultrafast “E” Series with High Reverse Energy Capability

... designed for use in switching power supplies, inverters and as free wheeling diodes, these state-of-the-art devices have the following features:

- 10 mJoules Avalanche Energy Guaranteed
- Excellent Protection Against Voltage Transients in Switching Inductive Load Circuits
- Ultrafast 75 Nanosecond Recovery Time
- 175°C Operating Junction Temperature
- Low Forward Voltage
- Low Leakage Current
- High Temperature Glass Passivated Junction
- Reverse Voltage to 1000 Volts

#### Mechanical Characteristics:

- Case: Epoxy, Molded
- Weight: 0.4 gram (approximately)
- Finish: All External Surfaces Corrosion Resistant and Terminal Leads are Readily Solderable
- Lead and Mounting Surface Temperature for Soldering Purposes: 220°C Max. for 10 Seconds, 1/16" from case
- Shipped in plastic bags, 1000 per bag
- Available Tape and Reeled, 5000 per reel, by adding a “RL” suffix to the part number
- Polarity: Cathode Indicated by Polarity Band
- Marking: MUR180E, MUR1100E

#### MAXIMUM RATINGS

Rating	Symbol	Value	Unit
Peak Repetitive Reverse Voltage Working Peak Reverse Voltage DC Blocking Voltage	$V_{RRM}$ $V_{RWM}$ $V_R$	800 1000	V
Average Rectified Forward Current (Note 1.) (Square Wave Mounting Method #3 Per Note 3.)	$I_{F(AV)}$	1.0 @ $T_A = 95^\circ\text{C}$	A
Non-Repetitive Peak Surge Current (Surge applied at rated load conditions, halfwave, single phase, 60 Hz)	$I_{FSM}$	35	A
Operating Junction Temperature and Storage Temperature Range	$T_J, T_{Stg}$	- 65 to +175	°C

1. Pulse Test: Pulse Width = 300  $\mu\text{s}$ , Duty Cycle  $\leq$  2.0%.



ON Semiconductor®

<http://onsemi.com>

ULTRAFAST  
RECTIFIERS  
1.0 AMPERES  
800-1000 VOLTS



AXIAL LEAD  
CASE 059-10  
PLASTIC

#### MARKING DIAGRAM

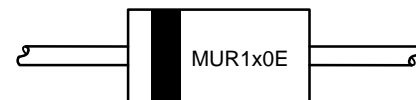

MUR1x0E = Device Code  
x = 8 or 10

#### ORDERING INFORMATION

Device	Package	Shipping
MUR180E	Axial Lead	1000 Units/Bag
MUR180ERL	Axial Lead	5000/Tape & Reel
MUR1100E	Axial Lead	1000 Units/Bag
MUR1100ERL	Axial Lead	5000/Tape & Reel

Preferred devices are recommended choices for future use and best overall value.

# MUR180E, MUR1100E

## THERMAL CHARACTERISTICS

Rating	Symbol	Value	Unit
Maximum Thermal Resistance, Junction to Ambient	$R_{\theta JA}$	See Note 3.	$^{\circ}C/W$

## ELECTRICAL CHARACTERISTICS

Maximum Instantaneous Forward Voltage (Note 2.) ( $i_F = 1.0$ Amp, $T_J = 150^{\circ}C$ ) ( $i_F = 1.0$ Amp, $T_J = 25^{\circ}C$ )	$v_F$	1.50 1.75	Volts
Maximum Instantaneous Reverse Current (Note 2.) (Rated dc Voltage, $T_J = 100^{\circ}C$ ) (Rated dc Voltage, $T_J = 25^{\circ}C$ )	$i_R$	600 10	$\mu A$
Maximum Reverse Recovery Time ( $I_F = 1.0$ Amp, $di/dt = 50$ Amp/ $\mu s$ ) ( $I_F = 0.5$ Amp, $i_R = 1.0$ Amp, $I_{REC} = 0.25$ Amp)	$t_{rr}$	100 75	ns
Maximum Forward Recovery Time ( $I_F = 1.0$ Amp, $di/dt = 100$ Amp/ $\mu s$ , Recovery to 1.0 V)	$t_{fr}$	75	ns
Controlled Avalanche Energy (See Test Circuit in Figure 6)	$W_{AVAL}$	10	mJ

2. Pulse Test: Pulse Width = 300  $\mu s$ , Duty Cycle  $\leq 2.0\%$ .

# MUR180E, MUR1100E

## ELECTRICAL CHARACTERISTICS

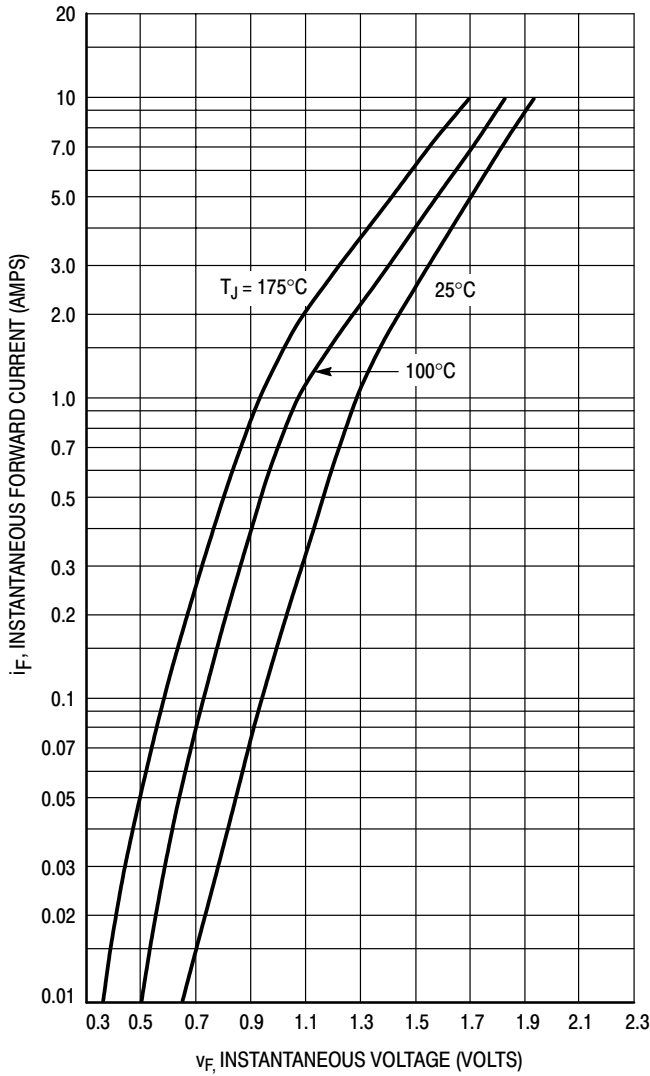

Figure 1. Typical Forward Voltage

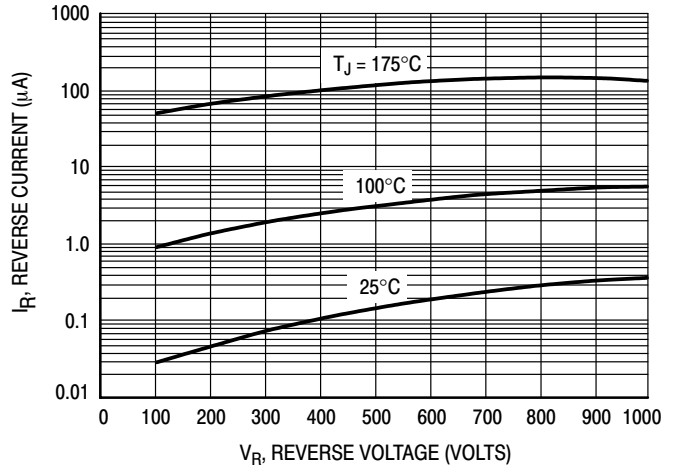

Figure 2. Typical Reverse Current\*

\* The curves shown are typical for the highest voltage device in the grouping. Typical reverse current for lower voltage selections can be estimated from these same curves if  $V_R$  is sufficiently below rated  $V_R$ .

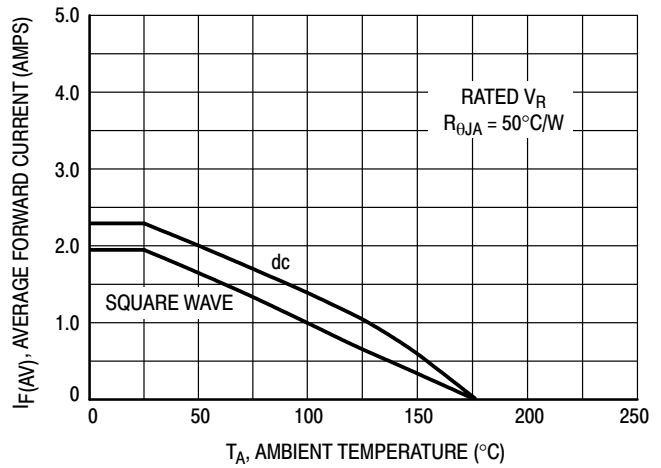

Figure 3. Current Derating  
(Mounting Method #3 Per Note 1)

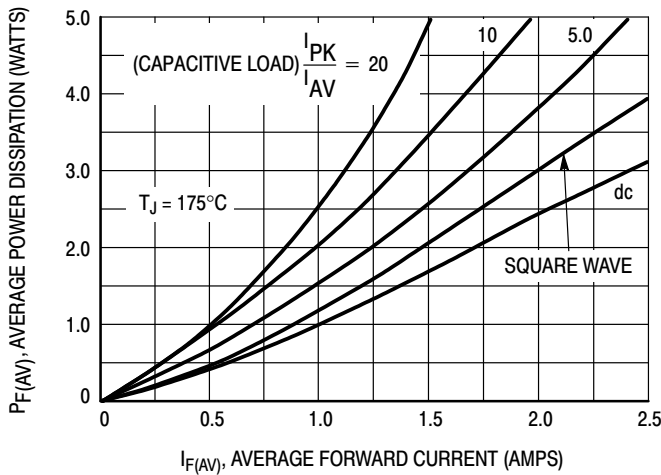

Figure 4. Power Dissipation

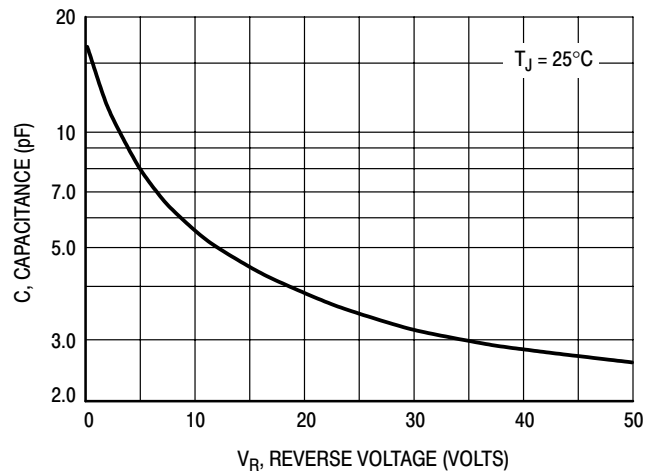

Figure 5. Typical Capacitance

# MUR180E, MUR1100E

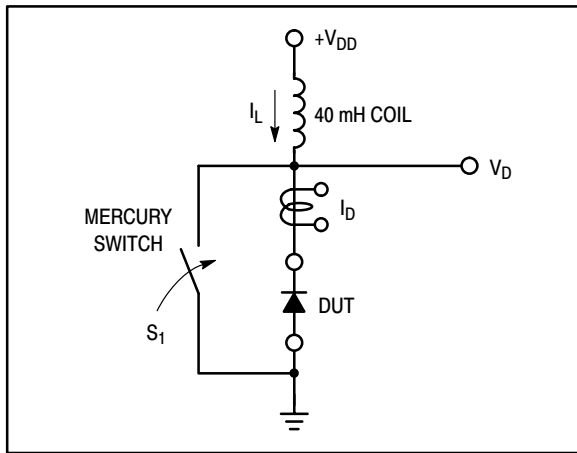

Figure 6. Test Circuit

The unclamped inductive switching circuit shown in Figure 6 was used to demonstrate the controlled avalanche capability of the new “E” series Ultrafast rectifiers. A mercury switch was used instead of an electronic switch to simulate a noisy environment when the switch was being opened.

When  $S_1$  is closed at  $t_0$  the current in the inductor  $I_L$  ramps up linearly; and energy is stored in the coil. At  $t_1$  the switch is opened and the voltage across the diode under test begins to rise rapidly, due to  $di/dt$  effects, when this induced voltage reaches the breakdown voltage of the diode, it is clamped at  $BV_{DUT}$  and the diode begins to conduct the full load current which now starts to decay linearly through the diode, and goes to zero at  $t_2$ .

By solving the loop equation at the point in time when  $S_1$  is opened; and calculating the energy that is transferred to the diode it can be shown that the total energy transferred is equal to the energy stored in the inductor plus a finite amount of energy from the  $V_{DD}$  power supply while the diode is in breakdown (from  $t_1$  to  $t_2$ ) minus any losses due to finite

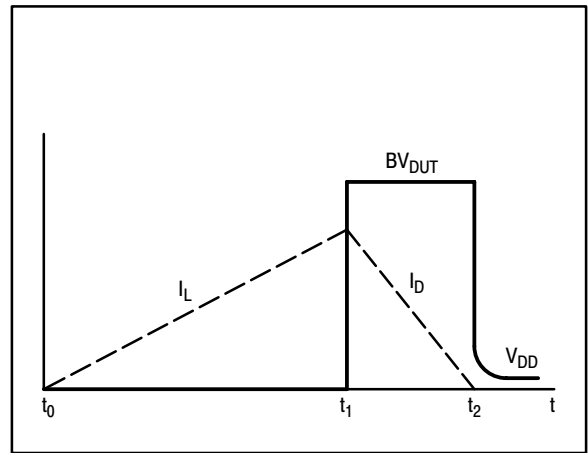

Figure 7. Current-Voltage Waveforms

component resistances. Assuming the component resistive elements are small Equation (1) approximates the total energy transferred to the diode. It can be seen from this equation that if the  $V_{DD}$  voltage is low compared to the breakdown voltage of the device, the amount of energy contributed by the supply during breakdown is small and the total energy can be assumed to be nearly equal to the energy stored in the coil during the time when  $S_1$  was closed, Equation (2).

The oscilloscope picture in Figure 8, shows the information obtained for the MUR8100E (similar die construction as the MUR1100E Series) in this test circuit conducting a peak current of one ampere at a breakdown voltage of 1300 volts, and using Equation (2) the energy absorbed by the MUR8100E is approximately 20 mjoules.

Although it is not recommended to design for this condition, the new “E” series provides added protection against those unforeseen transient viruses that can produce unexplained random failures in unfriendly environments.

EQUATION (1):

$$W_{AVAL} \approx \frac{1}{2} L I_{LPK}^2 \left( \frac{BV_{DUT}}{BV_{DUT} - V_{DD}} \right)$$

EQUATION (2):

$$W_{AVAL} \approx \frac{1}{2} L I_{LPK}^2$$

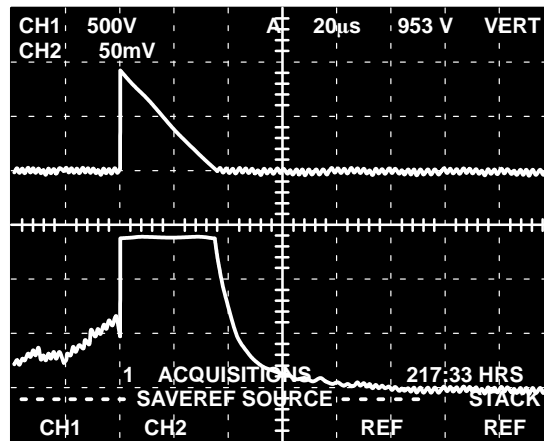

CHANNEL 2:  
 $I_L$   
0.5 AMPS/DIV.

CHANNEL 1:  
 $V_{DUT}$   
500 VOLTS/DIV.

TIME BASE:  
20  $\mu$ s/DIV.

Figure 8. Current-Voltage Waveforms

# MUR180E, MUR1100E

## NOTE 3. — AMBIENT MOUNTING DATA

Data shown for thermal resistance junction to ambient ( $R_{\theta JA}$ ) for the mountings shown is to be used as typical guideline values for preliminary engineering or in case the tie point temperature cannot be measured.

### TYPICAL VALUES FOR $R_{\theta JA}$ IN STILL AIR

Mounting Method	$R_{\theta JA}$	Lead Length, L			Units
		1/8	1/4	1/2	
1		52	65	72	$^{\circ}\text{C/W}$
2		67	80	87	$^{\circ}\text{C/W}$
3		50			$^{\circ}\text{C/W}$

#### MOUNTING METHOD 1

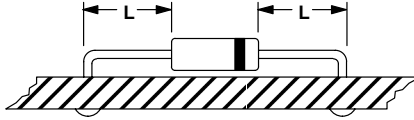

#### MOUNTING METHOD 2

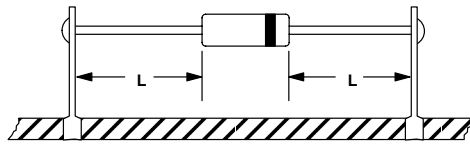

#### Vector Pin Mounting

#### MOUNTING METHOD 3

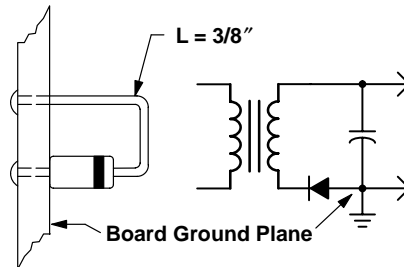

#### P.C. Board with 1-1/2" X 1-1/2" Copper Surface