

NAIS

LOW-PROFILE SURFACE-MOUNT RELAY

TQ-SMD RELAYS

FEATURES

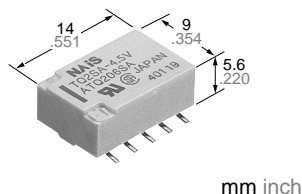

- **Low-profile:** 6 mm .236 inch in height conforming to EIA standards (Tape height: max. 6.5 mm .256 inch)
- **Tape and reel package is available as standard packing style**
- **Surge withstand between contacts and coil:** 2,500 V
- **Breakdown voltage between contacts and coil:** 1,500 V
- **High capacity:** 2 A
- **High sensitivity:** 2 Form C; 140 mW power consumption (Single side stable type)

SPECIFICATIONS

Contact			
Arrangement		2 Form C	
Initial contact resistance, max. (By voltage drop 6 V DC 1 A)		75 mΩ	
Contact material		Gold-clad silver alloy	
Rating	Nominal switching capacity (resistive load)	2 A 30 V DC, 0.5 A 125 V AC	
	Max. switching power (resistive load)	60 W, 62.5 VA	
	Max. switching voltage	220 V DC, 125 V AC	
	Max. switching current	2 A	
	Min. switching capacity ※1	10 μA 10 mV DC	
Nominal operating power	Single side stable	140 mW (1.5 to 12 V DC) 200 mW (24 V DC) 300 mW (48 V DC)	
	1 coil latching	70 mW (1.5 to 12 V DC) 100 mW (24 V DC)	
	2 coil latching	140 mW (1.5 to 12 V DC) 200 mW (24 V DC)	
Expected life (min. operations)	Mechanical (at 180 cpm)	10 ⁸	
	Electrical (at 20 cpm)	2 A 30 V DC resistive	10 ⁵
		1 A 30 V DC resistive	2×10 ⁵
		0.5 A 125 V AC resistive	10 ⁵

Note:
 ※1 This value can change due to the switching frequency, environmental conditions, and desired reliability level, therefore it is recommended to check this with the actual load.

Remarks
 * Specifications will vary with foreign standards certification ratings.
 *1 Measurement at same location as "Initial breakdown voltage" section.
 *2 By resistive method, nominal voltage applied to the coil; contact carrying current: 2 A.
 *3 Nominal voltage applied to the coil, excluding contact bounce time.
 *4 Nominal voltage applied to the coil, excluding contact bounce time without diode.
 *5 Half-wave pulse of sine wave: 6 ms; detection time: 10 μs
 *6 Half-wave pulse of sine wave: 6 ms
 *7 Detection time: 10 μs
 *8 Refer to 4. Conditions for operation, transport and storage mentioned in Cautions for use (Page 178).

Characteristics		
Initial insulation resistance*1		Min. 1,000 MΩ (at 500 V DC)
Initial breakdown voltage	Between open contacts	1,000 Vrms for 1 min. (Detection current: 10 mA)
	Between contact sets	1,500 Vrms for 1 min. (Detection current: 10 mA)
	Between contact and coil	1,500 Vrms for 1 min. (Detection current: 10 mA)
Initial surge voltage	Between open contacts (10×160 μs)	1,500 V (FCC Part 68)
	Between contacts and coil (2×10 μs)	2,500 V (Bellcore)
Temperature rise*2 (at 20°C)		Max. 50°C
Operate time [Set time]*3 (at 20°C)		Max. 4 ms (Approx. 2 ms) [Max. 4 ms (Approx. 2 ms)]
Release time [Reset time]*4 (at 20°C)		Max. 4 ms (Approx. 1 ms) [Max. 4 ms (Approx. 2 ms)]
Shock resistance	Functional*5	Min. 750 m/s ² {75 G}
	Destructive*6	Min. 1,000 m/s ² {100 G}
Vibration resistance	Functional*7	200 m/s ² {20G}, 10 to 55 Hz at double amplitude of 3.3 mm
	Destructive	294 m/s ² {30G}, 10 to 55 Hz at double amplitude of 5 mm
Conditions for operation, transport and storage*8 (Not freezing and condensing at low temperature)	Ambient temperature	-40°C to +85°C*3 -40°F to +185°F
	Humidity	5 to 85% R.H.
Unit weight		Approx. 2 g .071 oz

ORDERING INFORMATION

Ex. TQ 2 SA - L - 3V - Z

Contact arrangement	Surface-mount availability	Operating function	Coil voltage (DC)	Packing style
2: 2 Form C	SA: Standard surface-mount terminal type SL: High connection reliability surface-mount terminal type SS: Space saving surface-mount terminal type	Nil: Single side stable L: 1 coil latching L2: 2 coil latching	1.5, 3, 4.5, 5, 6, 9, 12, 24, 48* V	Nil: Tube packing Z: Tape and reel packing (picked from the 6/7/8/9/10-pin side)

Notes: 1. Tape and reel (picked from 1/2/3/4/5-pin side) is also available by request. Part No. suffix "-X" is needed when ordering. (ex.) TQ2SA-3V-X
2. Tape and reel packing symbol "-Z" or "-X" are not marked on the relay.

Surface-mount terminal variation

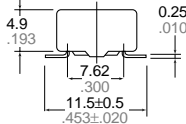
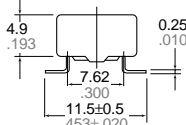
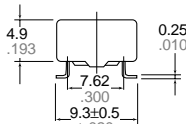
Variation	Terminal style	Ambient environment	
		Normal environments (indoor)	Drastic temperature fluctuations (outdoor)
SA type (Standard surface-mount terminal type)		Recommended	—
SL type (Highly connection reliability surface-mount terminal type)		Recommended	Recommended
SS type (Space saving surface-mount terminal type)		Recommended	Recommended

TYPES

1. Single side stable

Part No.	Nominal voltage, V DC	Pick-up voltage, V DC (max.)	Drop-out voltage, V DC (min.)	Nominal operating current, mA ($\pm 10\%$)	Coil resistance, Ω ($\pm 10\%$)	Nominal operating power, mW	Max. allowable voltage, V DC
TQ2SO-1.5 V	1.5	1.13	0.15	93.8	16	140	2.2
TQ2SO-3 V	3	2.25	0.3	46.7	64.3	140	4.5
TQ2SO-4.5 V	4.5	3.38	0.45	31	145	140	6.7
TQ2SO-5 V	5	3.75	0.5	28.1	178	140	7.5
TQ2SO-6 V	6	4.5	0.6	23.3	257	140	9
TQ2SO-9 V	9	6.75	0.9	15.5	579	140	13.5
TQ2SO-12 V	12	9	1.2	11.7	1,028	140	18
TQ2SO-24 V	24	18	2.4	8.3	2,880	200	36
TQ2SO-48 V	48	36	4.8	6.3	7,680	300	57.6

2. 1 coil latching

Part No.	Nominal voltage, V DC	Set voltage, V DC (max.)	Reset voltage, V DC (max.)	Nominal operating current, mA ($\pm 10\%$)	Coil resistance, Ω ($\pm 10\%$)	Nominal operating power, mW	Max. allowable voltage, V DC
TQ2SO-L-1.5 V	1.5	1.13	1.13	46.9	32	70	2.2
TQ2SO-L-3 V	3	2.25	2.25	23.3	128.6	70	4.5
TQ2SO-L-4.5 V	4.5	3.38	3.38	15.6	289.3	70	6.7
TQ2SO-L-5 V	5	3.75	3.75	14	357	70	7.5
TQ2SO-L-6 V	6	4.5	4.5	11.7	514	70	9
TQ2SO-L-9 V	9	6.75	6.75	7.8	1,157	70	13.5
TQ2SO-L-12 V	12	9	9	5.8	2,057	70	18
TQ2SO-L-24 V	24	18	18	4.2	5,760	100	36

TQ-SMD

3. 2 coil latching

Part No.	Nominal voltage, V DC	Set voltage, V DC (max.)	Reset voltage, V DC (max.)	Nominal operating current, mA ($\pm 10\%$)	Coil resistance, Ω ($\pm 10\%$)	Nominal operating power, mW	Max. allowable voltage, V DC
TQ2SO-L2-1.5 V	1.5	1.13	1.13	93.8	16	140	2.2
TQ2SO-L2-3 V	3	2.25	2.25	46.7	64.3	140	4.5
TQ2SO-L2-4.5 V	4.5	3.38	3.38	31	145	140	6.7
TQ2SO-L2-5 V	5	3.75	3.75	28.1	178	140	7.5
TQ2SO-L2-6 V	6	4.5	4.5	23.3	257	140	9
TQ2SO-L2-9 V	9	6.75	6.75	15.5	579	140	13.5
TQ2SO-L2-12 V	12	9	9	11.7	1,028	140	18
TQ2SO-L2-24 V	24	18	18	8.3	2,880	200	36

○: For each surface-mounted terminal variation, input the following letter.

SA type: A, SL type: L, SS type: S

Notes: 1. Specified value of the pick-up, drop-out, set and reset voltage is with the condition of square wave coil pulse.

2. Standard packing: Tube: 50 pcs.; Case; 1,000 pcs.; Tape and reel: 500 pcs./reel

3. In case of 5 V transistor drive circuit, it is recommended to use 4.5 V type relay.

DIMENSIONS

mm inch

SA type

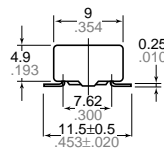
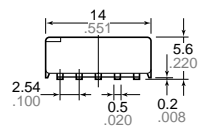

Recommendable mounting pad (Top view) SA type

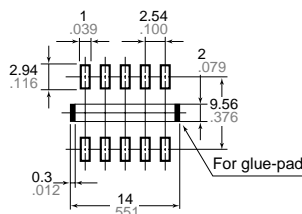

SL type

SL type

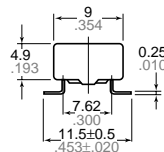
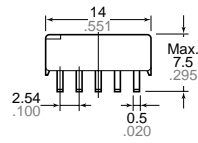
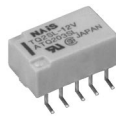

SS type

SS type

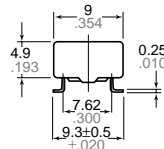
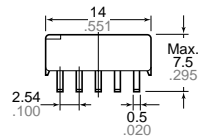

General tolerance: $\pm 0.3 \pm 0.012$

Tolerance: $\pm 0.1 \pm 0.004$

Schematic (Top view)

• Single side stable (Deenergized condition)

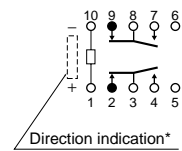

*Orientation stripe located on top of relay.

• 1-coil latching (Reset condition)

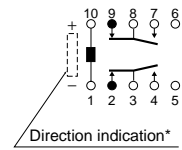

*Orientation stripe located on top of relay.

• 2-coil latching (Reset condition)

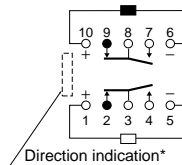

*Orientation stripe located on top of relay.

REFERENCE DATA

1. Maximum switching capacity

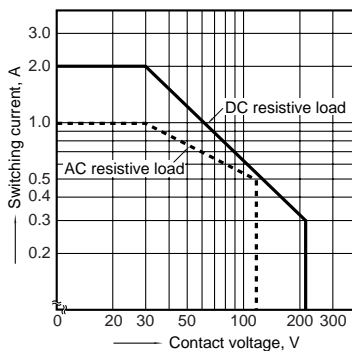

2. Life curve

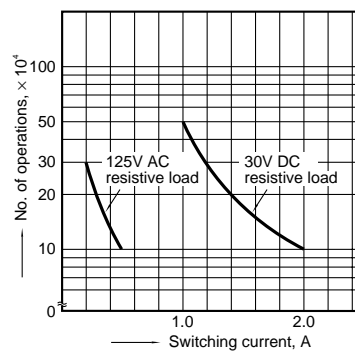

3. Mechanical life (mounting by IRS method)

Tested sample: TQ2SA-12V, 10 pcs.

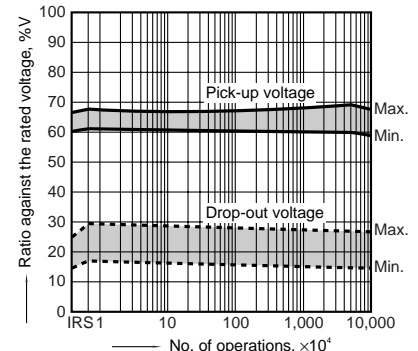

4.-(1) Electrical life (2 A 30 V DC resistive load)

Tested sample: TQ2SA-12V, 6 pcs.
 Operating frequency: 20 cpm
 Change of pick-up and drop-out voltage
 (mounting by IRS method)

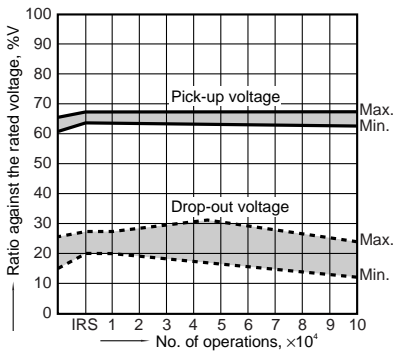

Change of contact resistance
 (mounting by IRS method)

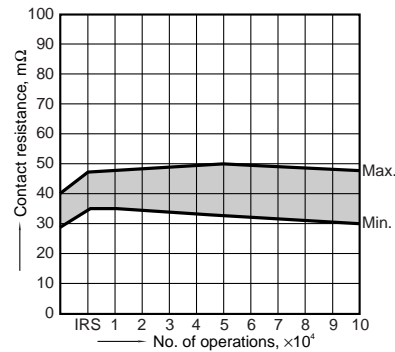

4.-(2) Electrical life (0.5 A 125 V AC resistive load)

Tested sample: TQ2SA-12V, 6 pcs.
 Operating frequency: 20 cpm
 Change of pick-up and drop-out voltage
 (mounting by IRS method)

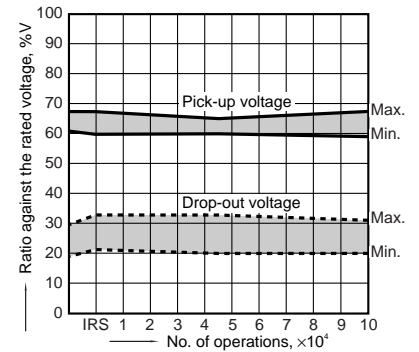

Change of contact resistance
 (mounting by IRS method)

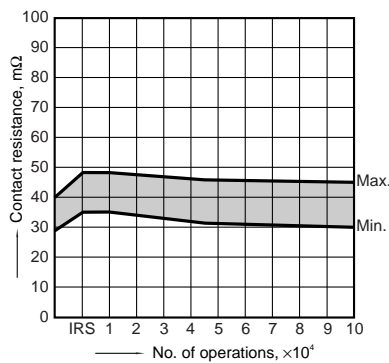

5. Coil temperature rise

Tested sample: TQ2SA-12V, 6 pcs.
 Point measured: Inside the coil
 Ambient temperature: 25°C 77°F

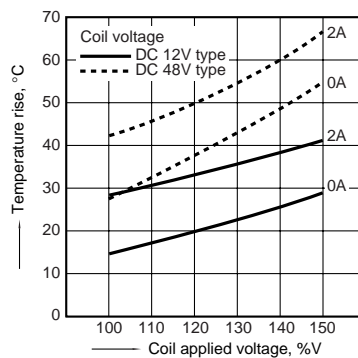

6. Operate/release time

Tested sample: TQ2SA-12V, 6 pcs.

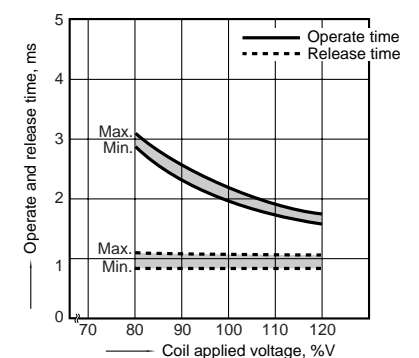

7. Distribution of pick-up and drop out voltage

Tested sample: TQ2SA-12V, 50 pcs.

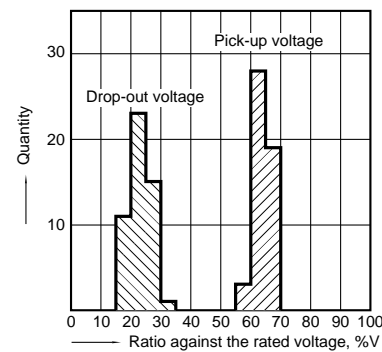

8. Distribution of set and reset voltage

Tested sample: TQ2SA-L-12V, 30 pcs.

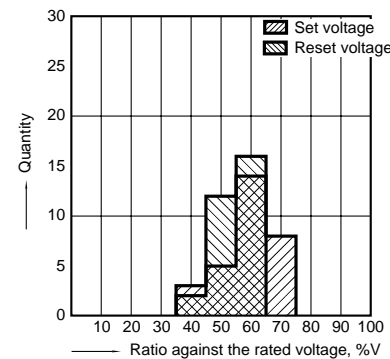

9. Ambient temperature characteristics

Tested sample: TQ2SA-12V, 5 pcs.

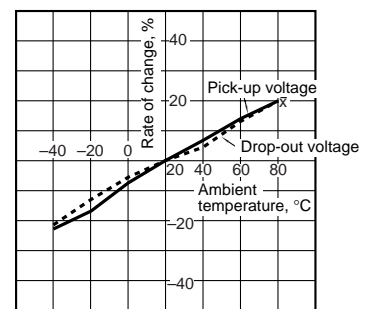

10. Distribution of contact resistance

Tested sample: TQ2SA-5V, 30 pcs. (30 x 4 contacts)

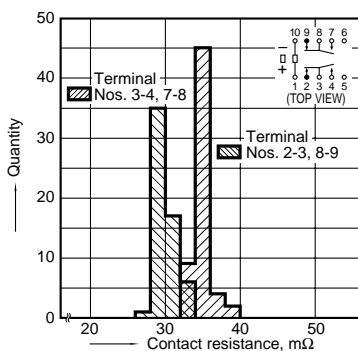

11.-(1) High-frequency characteristics

Isolation characteristics

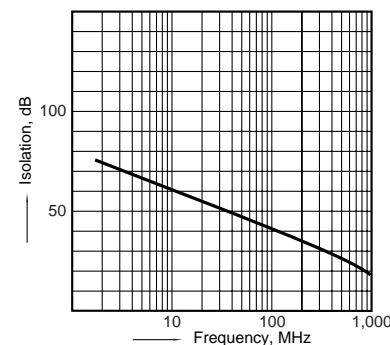

11.-(2) High-frequency characteristics

Insertion loss characteristics

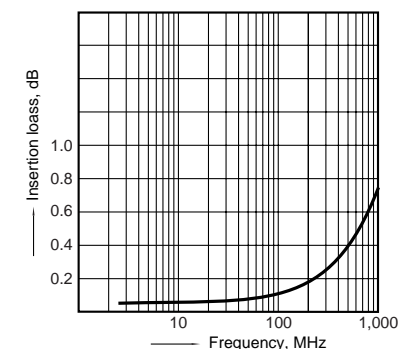

TQ-SMD

12.-(1) Malfunctional shock (single side stable)

Tested sample: TQ2SA-12V, 6 pcs

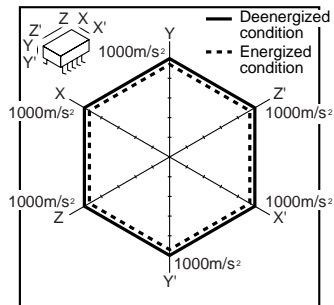

12.-(2) Malfunctional shock (latching)

Tested sample: TQ2SA-L2-12V, 6 pcs.

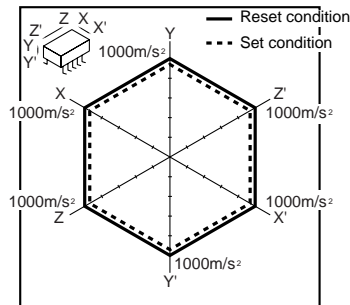

13.-(1) Influence of adjacent mounting

Tested sample: TQ2SA-12V, 5 pcs.

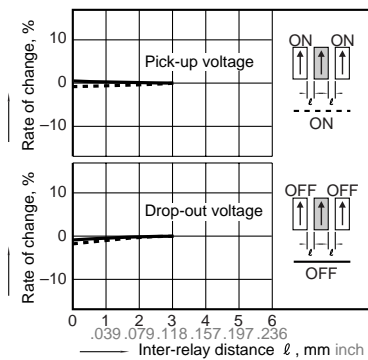

13.-(2) Influence of adjacent mounting

Tested sample: TQ2SA-12V, 6 pcs.

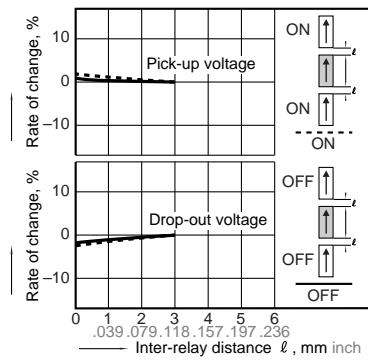

13.-(3) Influence of adjacent mounting

Tested sample: TQ2SA-12V, 6 pcs.

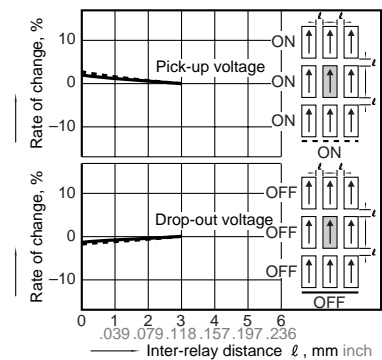

14. Pulse dialing test

Tested sample: TQ2SA-12V, 6 pcs.
(35 mA 48 V DC wire spring relay load)
Circuit

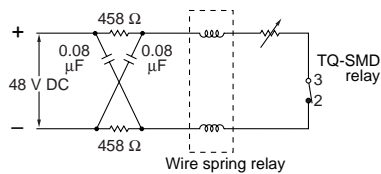

Change of pick-up and drop-out voltage (mounting by IRS method)

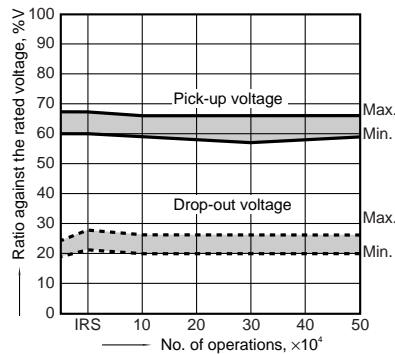

Change of contact resistance (mounting by IRS method)

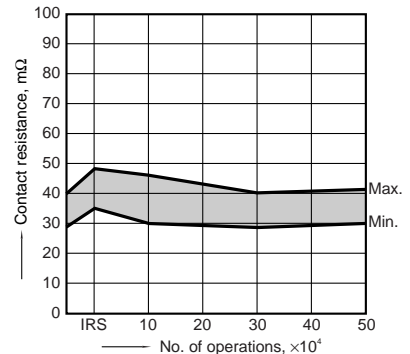

For Cautions for Use, see Page 178 and 179.