



**BC327-16/25/40**  
**BC328-16/25/40**

**Features**

- Lead Free Finish/RoHS Compliant ("P" Suffix designates RoHS Compliant. See ordering information)
- Capable of 0.625Watts of Power Dissipation.
- Collector-current : -0.8A
- Collector-base Voltage :  $V_{CBO} = -50V$ (BC327) ,  $V_{CBO} = -30V$ (BC328)
- Epoxy meets UL 94 V-0 flammability rating
- Moisture Sensitivity Level 1
- Halogen free available upon request by adding suffix "-HF"

**Maximum Ratings**

- Operating temperature : -55°C to +150°C
- Storage temperature : -55°C to +150°C

**Electrical Characteristics @ 25°C Unless Otherwise Specified**

Symbol	Parameter	Min	Max	Units
<b>OFF CHARACTERISTICS</b>				
$V_{(BR)CEO}$	Collector-Emitter Breakdown Voltage ( $I_C = -10mA$ , $I_B = 0$ )	BC327 -45 BC328 -25	---	Vdc
$V_{(BR)CBO}$	Collector-Base Breakdown Voltage ( $I_C = -100\mu A$ , $I_E = 0$ )	BC327 -50 BC328 -30	---	Vdc
$V_{(BR)EBO}$	Collector-Emitter Breakdown Voltage ( $I_E = -10\mu A$ , $I_C = 0$ )	-5.0	---	Vdc
$I_{CBO}$	Collector Cutoff Current ( $V_{CB} = -45V$ , $I_E = 0$ ) ( $V_{CB} = -25V$ , $I_E = 0$ )	BC327 ---	-0.1 -0.1	$\mu A$
$I_{CEO}$	Collector Cutoff Current ( $V_{CE} = -40V$ , $I_B = 0$ ) ( $V_{CE} = -20V$ , $I_B = 0$ )	BC327 ---	-0.2 -0.2	$\mu A$
$I_{EBO}$	Emitter Cutoff Current ( $V_{EB} = -4.0V$ , $I_C = 0$ )	---	-0.1	$\mu A$

**ON CHARACTERISTICS**

$h_{FE(1)}$	DC Current Gain ( $I_C = -100mA$ , $V_{CE} = -1.0V$ )	100	630	---
$h_{FE(2)}$	DC Current Gain ( $I_C = -300mA$ , $V_{CE} = -1.0V$ )	40	---	---
$V_{CE(sat)}$	Collector-Emitter Saturation Voltage ( $I_C = -500mA$ , $I_B = -50mA$ )	---	-0.7	Vdc
$V_{BE(sat)}$	Base-Emitter Saturation Voltage ( $I_C = -500mA$ , $I_B = -50mA$ )	---	-1.2	Vdc

**SMALL SIGNAL CHARACTERISTICS**

$f_T$	Current-Gain-Bandwidth Product ( $V_{CE} = 5.0V$ , $f = 100MHz$ , $I_C = 10mA$ )	260	---	MHz
-------	---	-----	-----	-----

**hFE CLASSIFICATION**

Classification	16	25	40
$h_{FE(1)}$	100~250	160~400	250~630
Marking Code	A 011	B 011	C 011

**PNP**  
**Plastic-Encapsulate**  
**Transistors**

**TO-92**

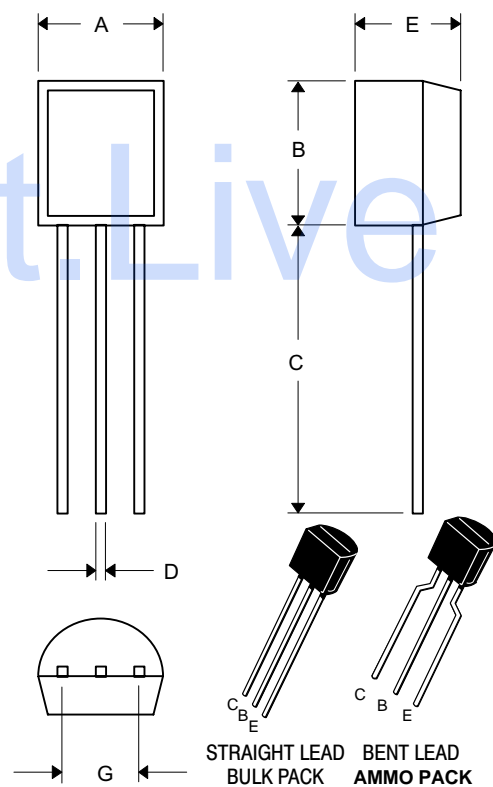

**DIMENSIONS**

DIM	INCHES		MM		NOTE
	MIN	MAX	MIN	MAX	
A	.175	.185	4.45	4.70	
B	.175	.185	4.45	4.70	
C	.500	---	12.70	---	
D	.016	.020	0.41	0.63	
E	.135	.145	3.43	3.68	
G	.095	.105	2.42	2.67	Straight Lead
	.173	.220	4.40	5.60	Bent Lead

\* For ammo packing detailed specification, click here to visit our website of product packaging for details.

Typical Characteristics

BC327

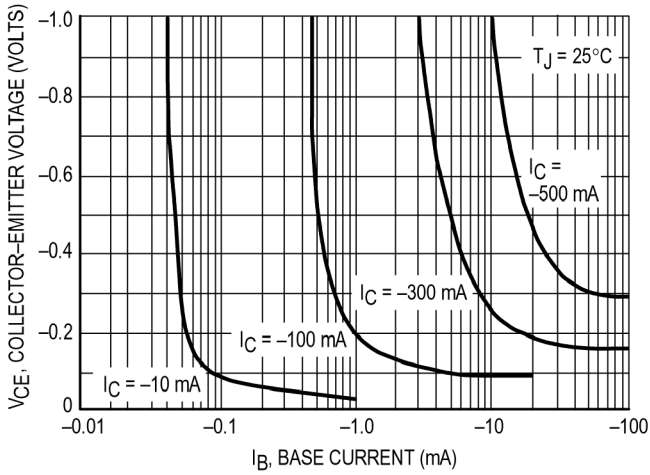

Saturation Region

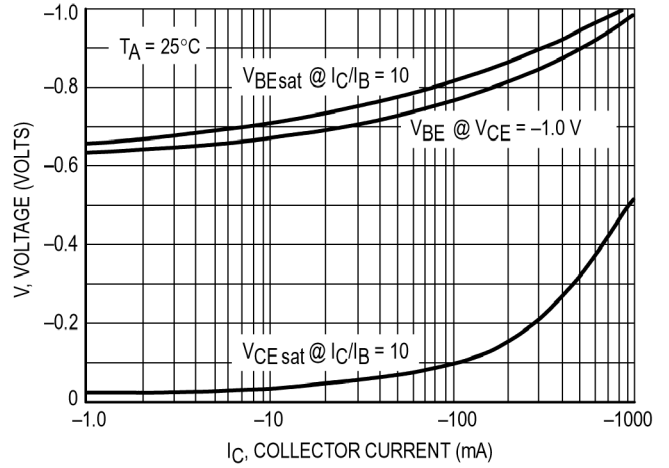

"On" Voltages

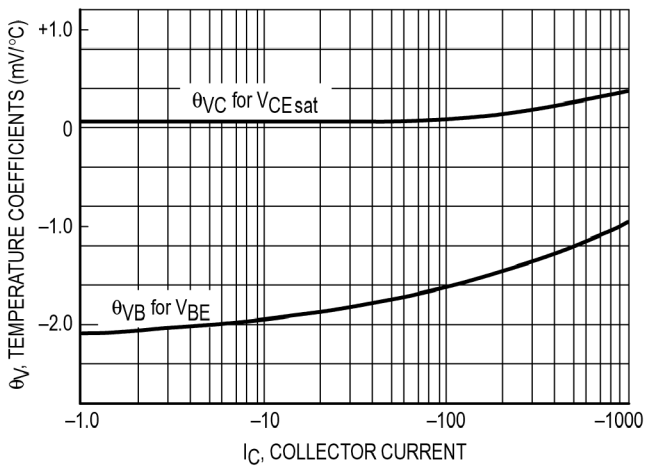

Temperature Coefficients

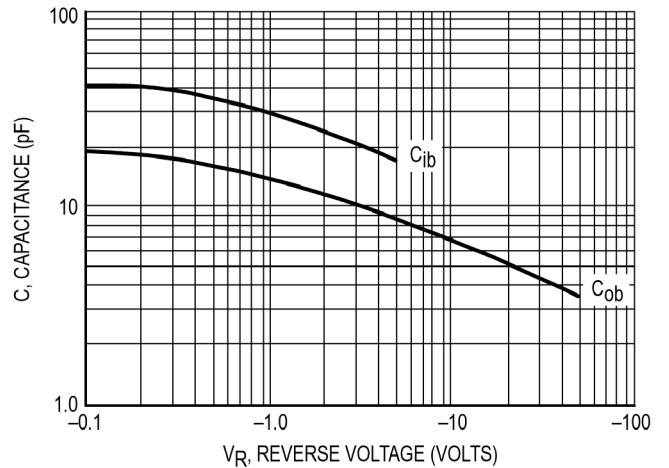

Capacitances

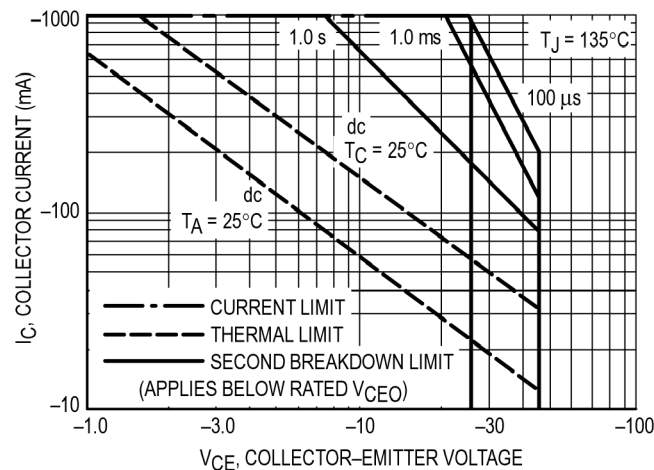

Active Region — Safe Operating Area

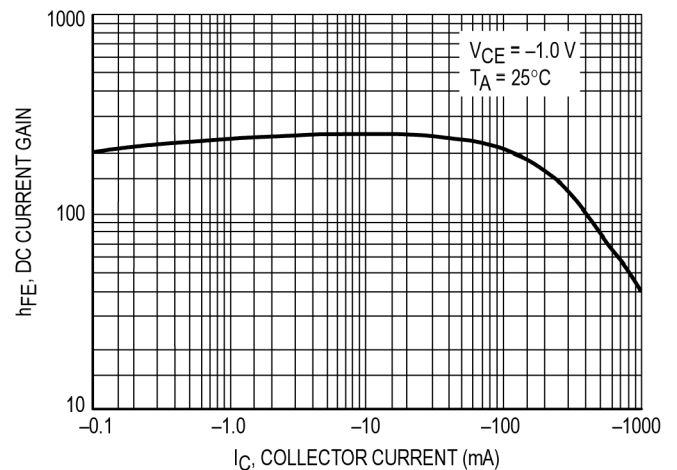

DC Current Gain



Micro Commercial Components

### Ordering Information :

Device	Packing
Part Number-AP	Ammo Packing: 20Kpcs/Carton
Part Number-BP	Bulk: 100Kpcs/Carton

Note : Adding "-HF" suffix for halogen free, eg. Part Number-AP-HF

**\*\*\*IMPORTANT NOTICE\*\*\***

**Micro Commercial Components Corp.** reserves the right to make changes without further notice to any product herein to make corrections, modifications, enhancements, improvements, or other changes. **Micro Commercial Components Corp.** does not assume any liability arising out of the application or use of any product described herein; neither does it convey any license under its patent rights, nor the rights of others. The user of products in such applications shall assume all risks of such use and will agree to hold **Micro Commercial Components Corp.** and all the companies whose products are represented on our website, harmless against all damages.

**\*\*\*LIFE SUPPORT\*\*\***

MCC's products are not authorized for use as critical components in life support devices or systems without the express written approval of Micro Commercial Components Corporation.

**\*\*\*CUSTOMER AWARENESS\*\*\***

Counterfeiting of semiconductor parts is a growing problem in the industry. Micro Commercial Components (MCC) is taking strong measures to protect ourselves and our customers from the proliferation of counterfeit parts. MCC strongly encourages customers to purchase MCC parts either directly from MCC or from Authorized MCC Distributors who are listed by country on our web page cited below. Products customers buy either from MCC directly or from Authorized MCC Distributors are genuine parts, have full traceability, meet MCC's quality standards for handling and storage. **MCC will not provide any warranty coverage or other assistance for parts bought from Unauthorized Sources.** MCC is committed to combat this global problem and encourage our customers to do their part in stopping this practice by buying direct or from authorized distributors.

[www.mccsemi.com](http://www.mccsemi.com)