

# 2061 THRU 2074

## 1.5 A DARLINGTON SWITCHES

**ULN2064/65B**

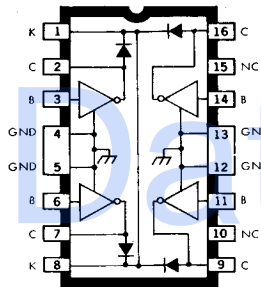

Dwg. No. A-9765A

**ABSOLUTE MAXIMUM RATINGS**  
at +25°C Free-Air Temperature  
for Any One Driver  
(unless otherwise noted)

Output Voltage, $V_{CEX}$ .....	See Guide
Output Sustaining Voltage, $V_{CE(SUS)}$ .....	See Guide
Output Current, $I_{OUT}$ (Note 1) .....	1.75 A
Input Voltage, $V_{IN}$ (Note 2) .....	See Guide
Input Current, $I_B$ (Note 3) .....	25 mA
Supply Voltage, $V_S$ (ULN2068B/LB & 2069B) .....	10 V
Total Package Power Dissipation, $P_D$ .....	See Graph
Operating Temperature Range, $T_A$ .....	-20°C to +85°C
Storage Temperature Range, $T_S$ .....	-55°C to -150°C

1. Allowable combinations of output current, number of outputs conducting, and duty cycle are shown on following pages.
2. Input voltage is referenced to the substrate (no connection to other pins) for the ULN2061/62M and ULN2074B, reference is ground for all other types.
3. Input current may be limited by maximum allowable input voltage.

High-voltage, high-current Darlington arrays ULN2061M through ULN2074B are designed for interface between low-level logic and a variety of peripheral loads such as relays, solenoids, dc and stepper motors, magnetic print hammers, multiplexed LED and incandescent displays, heaters, and similar loads. Output OFF voltage ratings of 50 V and 80 V are available. In the DIP, the quad drivers can drive resistive loads to 480 watts (1.5 A x 80 V, 26% duty cycle). For inductive loads, sustaining voltages of 35 V and 50 V at 100 mA are specified.

Dual-driver arrays ULN2061M and the higher-voltage ULN2062M are used for common-emitter (externally connected) or emitter-follower applications. They are supplied in 8-pin plastic mini-DIPs.

Quad drivers ULN2064B/LB, ULN2065B, ULN2068B/LB, and ULN2069B are intended for use with TTL, low-speed TTL, and 5 V MOS logic. The ULN2065B and ULN2069B are selected for the 80 V minimum output breakdown specification. The ULN2068B/LB and ULN2069B have pre-driver stages and are recommended for applications requiring high gain (low input-current loading). Isolated Darlington array ULN2074B is identical to the ULN2064B except for the isolated Darlington pinout and the deletion of suppression diodes. This switch is for emitter-follower applications. Quad-driver arrays are supplied with heat-sink contact tabs in 16-pin plastic DIPs (suffix B) and 20-lead surface-mountable wide-body SOICs (suffix LB).

### FEATURES

- TTL, DTL, MOS, CMOS Compatible Inputs
- Transient-Protected Outputs
- Loads to 480 Watts
- Heat-Sink Contact Tabs on Quad Arrays

Always order by complete part number, e.g., **ULN2061M**. See matrix on next page. Note that all devices are not available in all package types.

# 2061 THRU 2074 1.5 A DARLINGTON SWITCHES

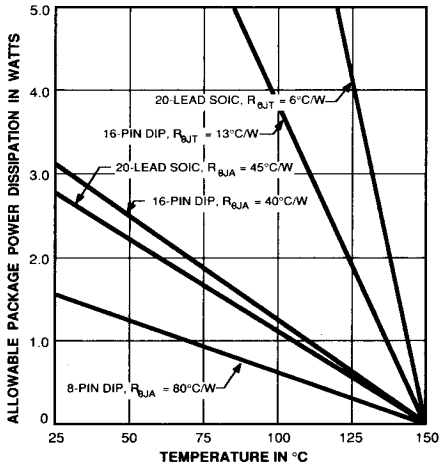

## SELECTION GUIDE

Part Number*	Max. $V_{CEX}$	Min. $V_{CE(SUS)}$	Max. $V_{IN}$	Application
ULN2061M	50 V	35 V	30 V	TTL, DTL, Schottky TTL, and 5 V CMOS
ULN2062M	80 V	50 V	60 V	
ULN2064B	50 V	35 V	15 V	TTL, DTL, Schottky TTL, and 5 V CMOS
ULN2064LB				
ULN2065B	80 V	50 V	15 V	TTL, DTL, Schottky TTL, and 5 V CMOS
ULN2068B	50 V	35 V	15 V	
ULN2068LB	80 V	50 V	15 V	
ULN2069B				
ULN2074B	50 V	35 V	30 V	General Purpose

\* Suffixes 'LB' are SOICs, 'B' and 'M' are DIPs.

## TEST FIGURES

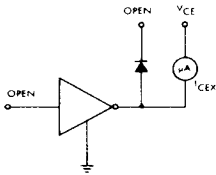

FIGURE 1

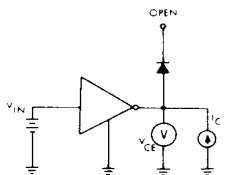

FIGURE 2

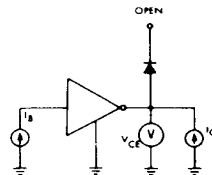

FIGURE 3

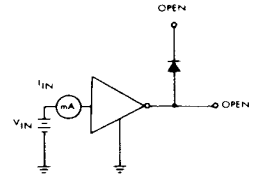

FIGURE 4

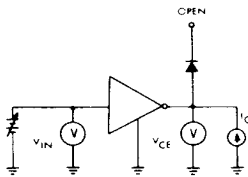

FIGURE 5

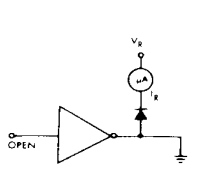

FIGURE 6

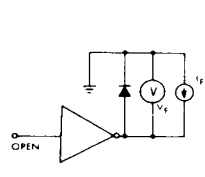

FIGURE 7

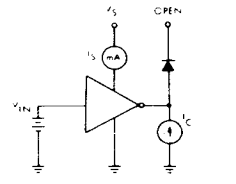
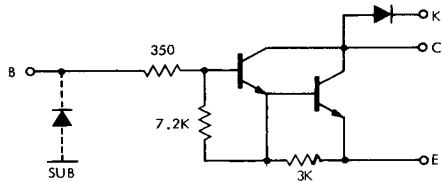

FIGURE 8

# 2061 THRU 2074 1.5 A DARLINGTON SWITCHES

## PARTIAL SCHEMATIC



Dwg. No. A-10,352B

## ULN2061/62M

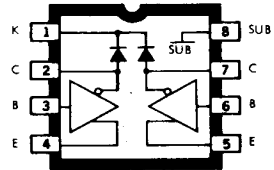

Dwg. No. A-10,230A

## ELECTRICAL CHARACTERISTICS at +25°C (unless otherwise noted).

Characteristic	Symbol	Test Fig.	Applicable Devices	Test Conditions	Limits		
					Min.	Max.	Units
Output Leakage Current	$I_{CEX}$	1	ULN2061M	$V_{CE} = 50 \text{ V}$	—	100	$\mu\text{A}$
				$V_{CE} = 50 \text{ V}, T_A = 70^\circ\text{C}$	—	500	$\mu\text{A}$
			ULN2062M	$V_{CE} = 80 \text{ V}$	—	100	$\mu\text{A}$
				$V_{CE} = 80 \text{ V}, T_A = 70^\circ\text{C}$	—	500	$\mu\text{A}$
Output Sustaining Voltage	$V_{CE(SUS)}$	2	ULN2061M	$I_C = 100 \text{ mA}, V_{IN} = 0.4 \text{ V}$	35	—	V
			ULN2062M	$I_C = 100 \text{ mA}, V_{IN} = 0.4 \text{ V}$	50	—	V
Collector-Emitter Saturation Voltage	$V_{CE(SAT)}$	3	Both	$I_C = 500 \text{ mA}, I_B = 625 \mu\text{A}$	—	1.1	V
				$I_C = 750 \text{ mA}, I_B = 935 \mu\text{A}$	—	1.2	V
				$I_C = 1.0 \text{ A}, I_B = 1.25 \text{ mA}$	—	1.3	V
				$I_C = 1.25 \text{ A}^{**}, I_B = 2.0 \text{ mA}$	—	1.4	V
			ULN2062M	$I_C = 1.5 \text{ A}^{**}, I_B = 2.25 \text{ mA}$	—	1.5	V
Input Current	$I_{IN(ON)}$	4	Both	$V_{IN} = 2.4 \text{ V}$	1.4	4.3	mA
				$V_{IN} = 3.75 \text{ V}$	3.3	9.6	mA
Input Voltage	$V_{IN(ON)}$	5	Both	$V_{CE} = 2.0 \text{ V}, I_C = 1.0 \text{ A}$	—	2.0	V
			ULN2061M	$V_{CE} = 2.0 \text{ V}, I_C = 1.25 \text{ A}^{**}$	—	2.5	V
			ULN2062M	$V_{CE} = 2.0 \text{ V}, I_C = 1.5 \text{ A}^{**}$	—	2.5	V
Turn-On Delay	$t_{PLH}$	—	Both	$0.5 E_{in}$ to $0.5 E_{out}$	—	1.0	$\mu\text{s}$
Turn-Off Delay	$t_{PHL}$	—	Both	$0.5 E_{in}$ to $0.5 E_{out}$	—	1.5	$\mu\text{s}$
Clamp Diode Leakage Current	$I_R$	6	ULN2061M	$V_R = 50 \text{ V}$	—	50	$\mu\text{A}$
				$V_R = 50 \text{ V}, T_A = 70^\circ\text{C}$	—	100	$\mu\text{A}$
			ULN2062M	$V_R = 80 \text{ V}$	—	50	$\mu\text{A}$
				$V_R = 80 \text{ V}, T_A = 70^\circ\text{C}$	—	100	$\mu\text{A}$
Clamp Diode Forward Voltage	$V_F$	7	Both	$I_F = 1.0 \text{ A}$	—	1.75	V
				$I_F = 1.5 \text{ A}$	—	2.0	V

\*\*Pulse-Test

# 2061 THRU 2074 1.5 A DARLINGTON SWITCHES

## PARTIAL SCHEMATIC

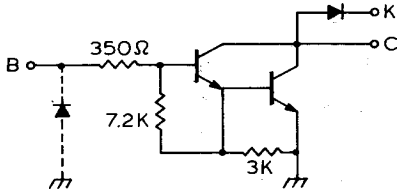

Dwg. No. A-10.353C

## ULN2064/65B

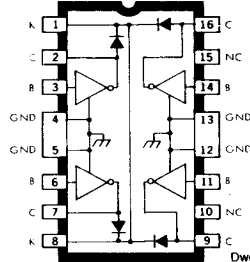

Dwg. No. A-9765A

## ULN2064LB

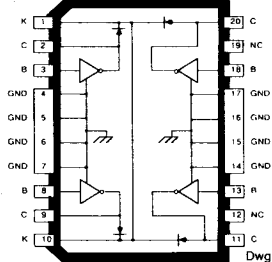

Dwg. No. A-14.326

## ELECTRICAL CHARACTERISTICS at +25°C (unless otherwise noted).

Characteristic	Symbol	Test Fig.	Applicable Devices	Test Conditions	Limits		
					Min.	Max.	Units
Output Leakage Current	$I_{CEX}$	1	ULN2064*	$V_{CE} = 50\text{ V}$	—	100	$\mu\text{A}$
				$V_{CE} = 50\text{ V}, T_A = 70^\circ\text{C}$	—	500	$\mu\text{A}$
			ULN2065B	$V_{CE} = 80\text{ V}$	—	100	$\mu\text{A}$
				$V_{CE} = 80\text{ V}, T_A = 70^\circ\text{C}$	—	500	$\mu\text{A}$
Output Sustaining Voltage	$V_{CE(SUS)}$	2	ULN2064*	$I_C = 100\text{ mA}, V_{IN} = 0.4\text{ V}$	35	—	V
			ULN2065B	$I_C = 100\text{ mA}, V_{IN} = 0.4\text{ V}$	50	—	V
Collector-Emitter Saturation Voltage	$V_{CE(SAT)}$	3	Both	$I_C = 500\text{ mA}, I_B = 625\text{ }\mu\text{A}$	—	1.1	V
				$I_C = 750\text{ mA}, I_B = 935\text{ }\mu\text{A}$	—	1.2	V
				$I_C = 1.0\text{ A}, I_B = 1.25\text{ mA}$	—	1.3	V
				$I_C = 1.25\text{ A}, I_B = 2.0\text{ mA}$	—	1.4	V
			ULN2065B	$I_C = 1.5\text{ A}, I_B = 2.25\text{ mA}$	—	1.5	V
Input Current	$I_{IN(ON)}$	4	Both	$V_{IN} = 2.4\text{ V}$	1.4	4.3	mA
				$V_{IN} = 3.75\text{ V}$	3.3	9.6	mA
Input Voltage	$V_{IN(ON)}$	5	Both	$V_{CE} = 2.0\text{ V}, I_C = 1.0\text{ A}$	—	2.0	V
			ULN2064*	$V_{CE} = 2.0\text{ V}, I_C = 1.25\text{ A}$	—	2.5	V
			ULN2065B	$V_{CE} = 2.0\text{ V}, I_C = 1.5\text{ A}$	—	2.5	V
Turn-On Delay	$t_{PLH}$	—	Both	$0.5 E_{in}$ to $0.5 E_{out}$	—	1.0	$\mu\text{s}$
Turn-Off Delay	$t_{PHL}$	—	Both	$0.5 E_{in}$ to $0.5 E_{out}$	—	1.5	$\mu\text{s}$
Clamp Diode Leakage Current	$I_R$	6	ULN2064*	$V_R = 50\text{ V}$	—	50	$\mu\text{A}$
				$V_R = 50\text{ V}, T_A = 70^\circ\text{C}$	—	100	$\mu\text{A}$
			ULN2065B	$V_R = 80\text{ V}$	—	50	$\mu\text{A}$
				$V_R = 80\text{ V}, T_A = 70^\circ\text{C}$	—	100	$\mu\text{A}$
Clamp Diode Forward Voltage	$V_F$	7	Both	$I_F = 1.0\text{ A}$	—	1.75	V
				$I_F = 1.5\text{ A}$	—	2.0	V

\* Complete part number includes suffix to identify package style: B = DIP with heat sink tabs, LB = SOIC with heat sink tabs.

# 2061 THRU 2074 1.5 A DARLINGTON SWITCHES

## PARTIAL SCHEMATIC

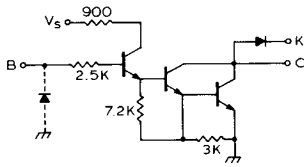

Dwg. No. A-10,354C

## ULN2068/69B

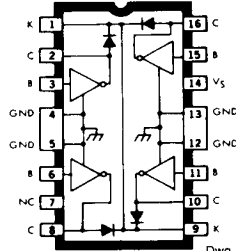

Dwg. No. A-10,310

## ULN2068LB

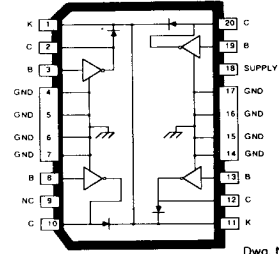

Dwg. No. A-14,327

## ELECTRICAL CHARACTERISTICS at +25°C, V<sub>S</sub> = 5.0 V (unless otherwise noted).

Characteristic	Symbol	Test Fig.	Applicable Devices	Test Conditions	Limits		
					Min.	Max.	Units
Output Leakage Current	I <sub>CEX</sub>	1	ULN2068*	V <sub>CE</sub> = 50 V	—	100	μA
				V <sub>CE</sub> = 50 V, T <sub>A</sub> = 70°C	—	500	μA
			ULN2069B	V <sub>CE</sub> = 80 V	—	100	μA
				V <sub>CE</sub> = 80 V, T <sub>A</sub> = 70°C	—	500	μA
Output Sustaining Voltage	V <sub>CE(SUS)</sub>	2	ULN2069*	I <sub>C</sub> = 100 mA, V <sub>IN</sub> = 0.4 V	35	—	V
			ULN2069B	I <sub>C</sub> = 100 mA, V <sub>IN</sub> = 0.4 V	50	—	V
Collector-Emitter Saturation Voltage	V <sub>CE(SAT)</sub>	3	Both	I <sub>C</sub> = 500 mA, V <sub>IN</sub> = 2.75 V	—	1.1	V
				I <sub>C</sub> = 750 mA, V <sub>IN</sub> = 2.75 V	—	1.2	V
				I <sub>C</sub> = 1.0 A, V <sub>IN</sub> = 2.75 V	—	1.3	V
				I <sub>C</sub> = 1.25 A, V <sub>IN</sub> = 2.75 V	—	1.4	V
			ULN2069B	I <sub>C</sub> = 1.5 A, V <sub>IN</sub> = 2.75 V	—	1.5	V
Input Current	I <sub>IN(ON)</sub>	4	Both	V <sub>IN</sub> = 2.75 V	—	550	μA
				V <sub>IN</sub> = 3.75 V	—	1000	μA
Input Voltage	V <sub>IN(ON)</sub>	5	ULN2068*	V <sub>CE</sub> = 2.0 V, I <sub>C</sub> = 1.25 A	—	2.75	V
			ULN2069B	V <sub>CE</sub> = 2.0 V, I <sub>C</sub> = 1.5 A	—	2.75	V
Supply Current	I <sub>S</sub>	8	Both	I <sub>C</sub> = 500 mA, V <sub>IN</sub> = 2.75 V	—	6.0	V
Turn-On Delay	t <sub>PLH</sub>	—	Both	0.5 E <sub>in</sub> to 0.5 E <sub>out</sub>	—	1.0	μs
Turn-Off Delay	t <sub>PHL</sub>	—	Both	0.5 E <sub>in</sub> to 0.5 E <sub>out</sub> , I <sub>C</sub> = 1.25 A	—	1.5	μs
Clamp Diode Leakage Current	I <sub>R</sub>	6	ULN2068*	V <sub>R</sub> = 50 V	—	50	μA
				V <sub>R</sub> = 50 V, T <sub>A</sub> = 70°C	—	100	μA
			ULN2069B	V <sub>R</sub> = 80 V	—	50	μA
				V <sub>R</sub> = 80 V, T <sub>A</sub> = 70°C	—	100	μA
Clamp Diode Forward Voltage	V <sub>F</sub>	7	Both	I <sub>F</sub> = 1.0 A	—	1.75	V
				I <sub>F</sub> = 1.5 A	—	2.0	V

\*Complete part number includes suffix to identify package style: B = DIP with heat sink tabs, LB = SOIC with heat sink tabs.

# 2061 THRU 2074 1.5 A DARLINGTON SWITCHES

**PARTIAL SCHEMATIC**

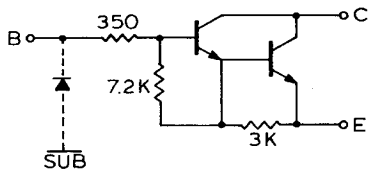

**ULN2074B**

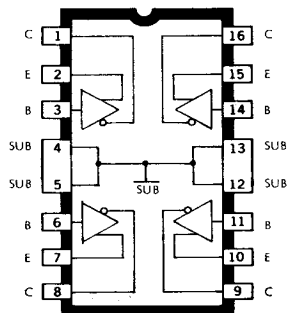

Dwg. No. A-10,356B

Dwg. No. A-9766

**ELECTRICAL CHARACTERISTICS at +25°C (unless otherwise noted).**

Characteristic	Symbol	Test Fig.	Test Conditions	Limits		
				Min.	Max.	Units
Output Leakage Current	$I_{CEX}$	1	$V_{CE} = 50 \text{ V}$	—	100	$\mu\text{A}$
			$V_{CE} = 50 \text{ V}, T_A = 70^\circ\text{C}$	—	500	$\mu\text{A}$
Output Sustaining Voltage	$V_{CE(SUS)}$	2	$I_C = 100 \text{ mA}, V_{IN} = 0.4 \text{ V}$	35	—	V
Collector-Emitter Saturation Voltage	$V_{CE(SAT)}$	3	$I_C = 500 \text{ mA}, I_B = 625 \mu\text{A}$	—	1.1	V
			$I_C = 750 \text{ mA}, I_B = 935 \mu\text{A}$	—	1.2	V
			$I_C = 1.0 \text{ A}, I_B = 1.25 \text{ mA}$	—	1.3	V
			$I_C = 1.25 \text{ A}, I_B = 2.0 \text{ mA}$	—	1.4	V
Input Current	$I_{IN(ON)}$	4	$V_{IN} = 2.4 \text{ V}$	1.4	4.3	mA
			$V_{IN} = 3.75 \text{ V}$	3.3	9.6	mA
Input Voltage	$V_{IN(ON)}$	5	$V_{CE} = 2.0 \text{ V}, I_C = 1.0 \text{ A}$	—	2.0	V
			$V_{CE} = 2.0 \text{ V}, I_C = 1.25 \text{ A}$	—	2.5	V
Turn-On Delay	$t_{PLH}$	—	$0.5 E_{in}$ to $0.5 E_{out}$	—	1.0	$\mu\text{s}$
Turn-Off Delay	$t_{PHL}$	—	$0.5 E_{in}$ to $0.5 E_{out}$	—	1.5	$\mu\text{s}$

# 2061 THRU 2074 1.5 A DARLINGTON SWITCHES

## INPUT CURRENT AS A FUNCTION OF INPUT VOLTAGE AT +25°C

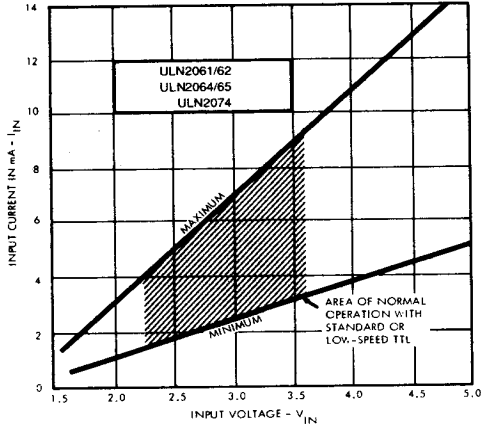

Dwg. No. A-10,363C

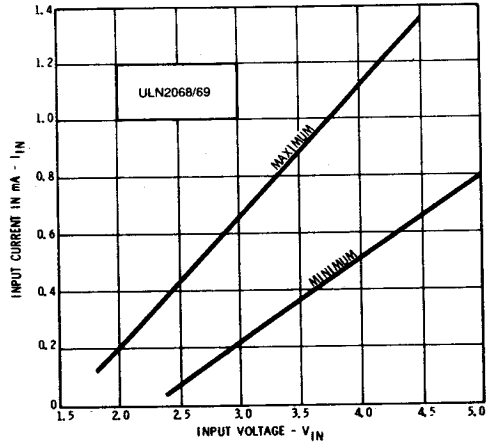

Dwg. No. A-12,306A

## COLLECTOR CURRENT AS A FUNCTION OF INPUT CURRENT AT +25°C

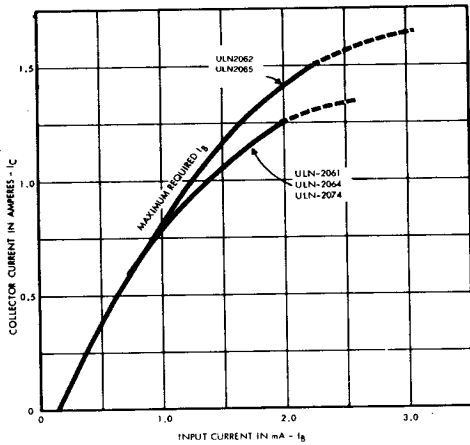

Dwg. No. A-10,358C

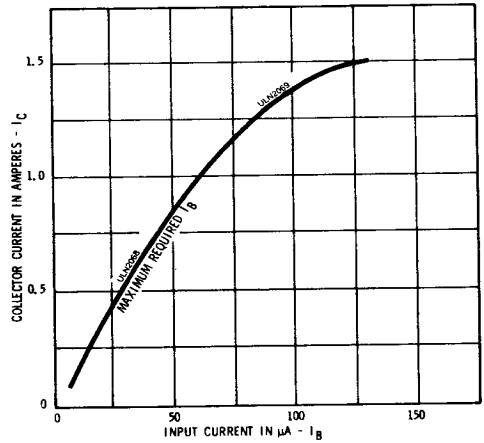

Dwg. No. A-12,306A

# 2061 THRU 2074 1.5 A DARLINGTON SWITCHES

## PEAK COLLECTOR CURRENT AS A FUNCTION OF DUTY CYCLE (DUAL IN-LINE PACKAGED DEVICES)

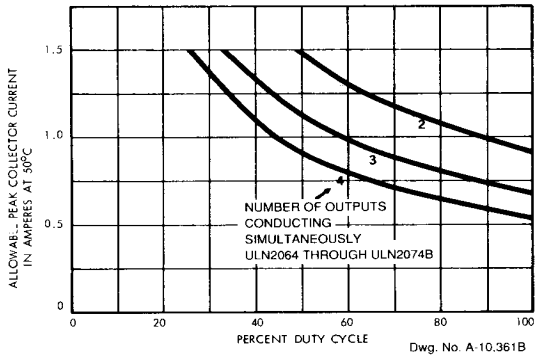
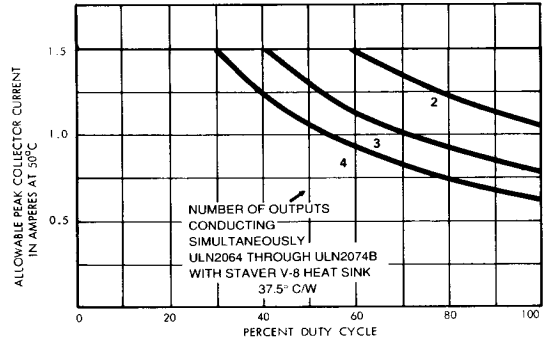
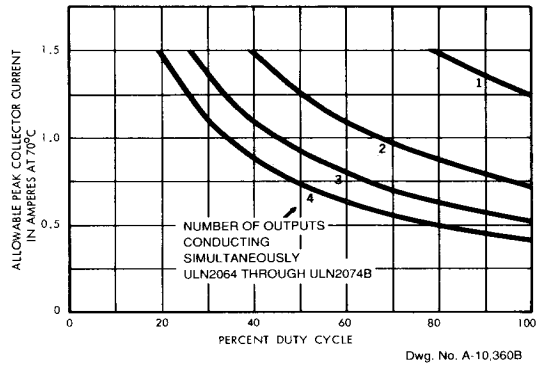
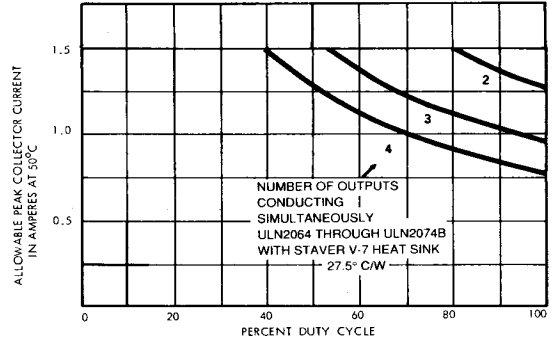
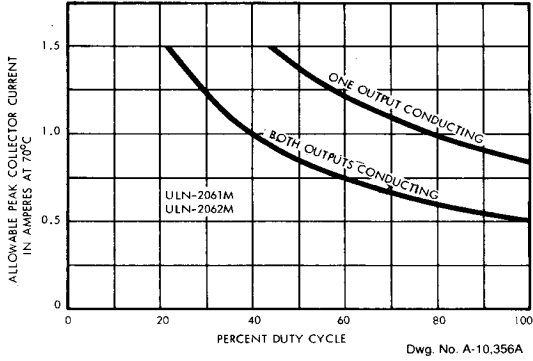



# 2061 THRU 2074 1.5 A DARLINGTON SWITCHES

## PEAK COLLECTOR CURRENT AS A FUNCTION OF DUTY CYCLE (DUAL IN-LINE PACKAGED DEVICES, cont'd)

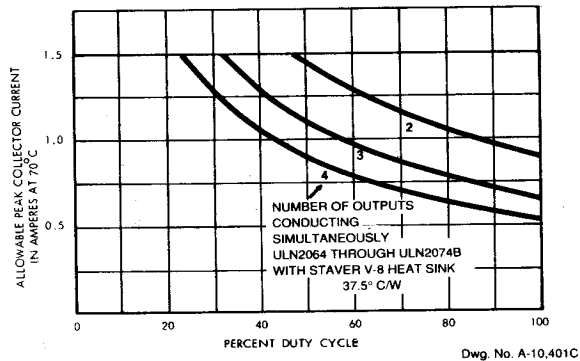
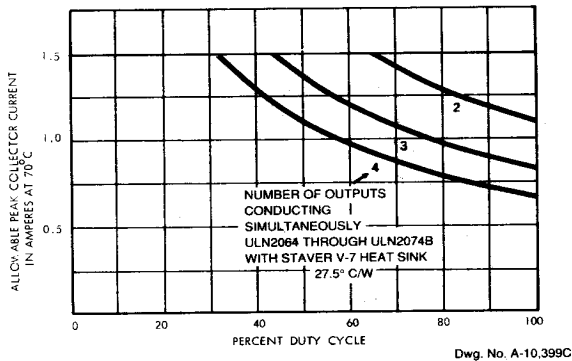

### (ULN2064LB and ULN2068LB only)

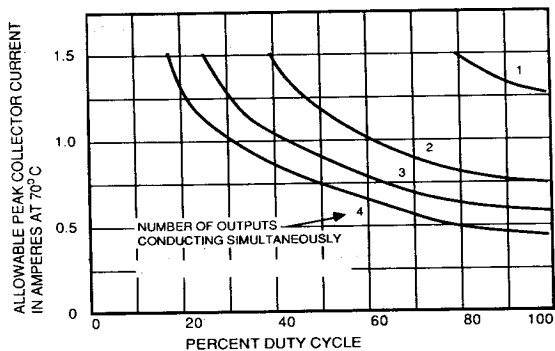
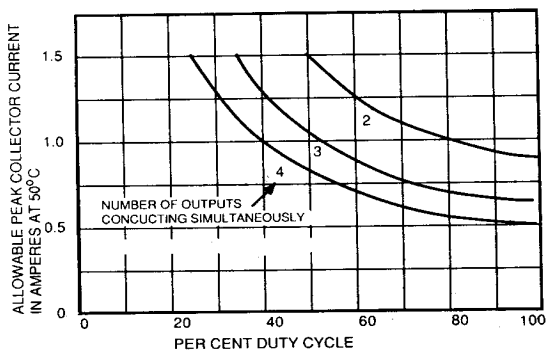

# 2061 THRU 2074 1.5 A DARLINGTON SWITCHES

## TYPICAL APPLICATIONS

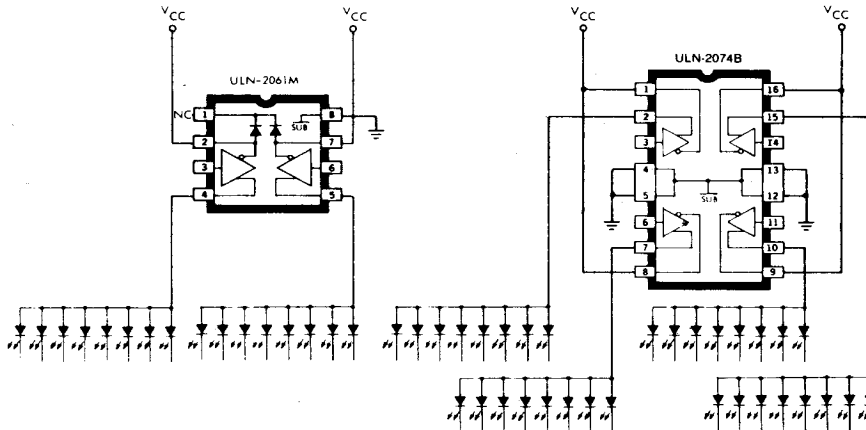

Dwg. No. B-1364A

## COMMON-ANODE LED DRIVERS

(Series UDN2980A/EP/LW devices can be used in similar applications at currents of up to 500 mA)

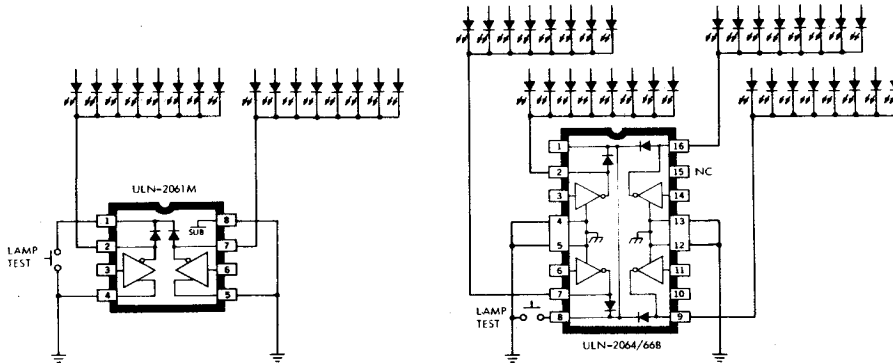

Dwg. No. B-1365

## COMMON-CATHODE LED DRIVERS

(Type ULN2068B/LB is also applicable)