

HLCP-A100

LED Light Bars



Data Sheet

HLCP-A100/-B100/-C100/D100/-E100/-F100/-G100/-H100
HLMP-2300/-2350/-2400/-2450/-2500/-2550
HLMP-2600/-2620/-2635/-2655/-2670/-2685
HLMP-2700/-2720/-2735/-2755/-2770/-2785
HLMP-2800/-2820/-2835/-2855/-2870/-2885
HLMP-2950/-2965

Description

The HLCP-X100 and HLMP-2XXX series light bars are rectangular light sources designed for a variety of applications where a large bright source of light is required. These light bars are configured in single-in-line and dual-in-line packages that contain either single or segmented light emitting areas. The AlGaAs Red HLCP-X100 series LEDs use double hetero-junction AlGaAs on a GaAs substrate. The HER HLMP-2300/2600 and Yellow HLMP-2400/2700 series LEDs have their p-n junctions diffused into a GaAsP epitaxial layer on a GaP substrate. The Green HLMP-2500/2800 series LEDs use a liquid phase GaP epitaxial layer on a GaP substrate. The bicolor HLMP-2900 series use a combination of HER/Yellow or HER/Green LEDs.

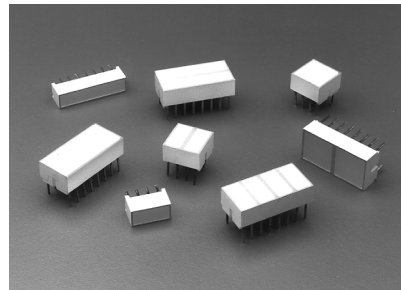











Features

- Large bright, uniform light emitting areas
- Choice of colors
- Categorized for light output
- Yellow and Green categorized for dominant wavelength
- Excellent ON-OFF contrast
- X-Y stackable
- Flush mountable
- Can be used with panel and legend mounts
- Light emitting surface suitable for legend attachment per Application Note 1012
- HLCP-X100 Series designed for low current operation
- Bicolor devices available

Applications

- Business machine message annunciators
- Telecommunications indicators
- Front panel process status indicators
- PC board identifiers
- Bar graphs

Selection Guide

Light Bar Part Number				Size of Light Emitting Areas	Number of Light Emitting Areas	Package Outline		Corresponding Panel and Legend Mount Part No. HLMP-
HLCP-	HLMP-							
AlGaAs	HER	Yellow	Green					
A100	2300	2400	2500	8.89 mm x 3.81 mm (.350 in. x .150 in.)	1	A		2599
B100	2350	2450	2550	19.05 mm x 3.81 mm (.750 in. x .150 in.)	1	B		2598
D100	2600	2700	2800	8.89 mm x 3.81 mm (.350 in. x .150 in.)	2	D		2898
E100	2620	2720	2820	8.89 mm x 3.81 mm (.350 in. x .150 in.)	4	E		2899
F100	2635	2735	2835	3.81 mm x 19.05 mm (.150 in. x .750 in.)	2	F		2899
C100	2655	2755	2855	8.89 mm x 8.89 mm (.350 in. x .350 in.)	1	C		2898
G100	2670	2770	2870	8.89 mm x 8.89 mm (.350 in. x .350 in.)	2	G		2899
H100	2685	2785	2885	8.89 mm x 19.05 mm (.350 in. x .750 in.)	1	H		2899
	2950	2950		8.89 mm x 8.89 mm (.350 in. x .350 in.)	Bicolor	I		2898
	2965		2965	8.89 mm x 8.89 mm (.350 in. x .350 in.)	Bicolor	I		2898

Part Numbering System

HLCP - xx xx - xx x xx

HLMP - xx xx - xx x xx

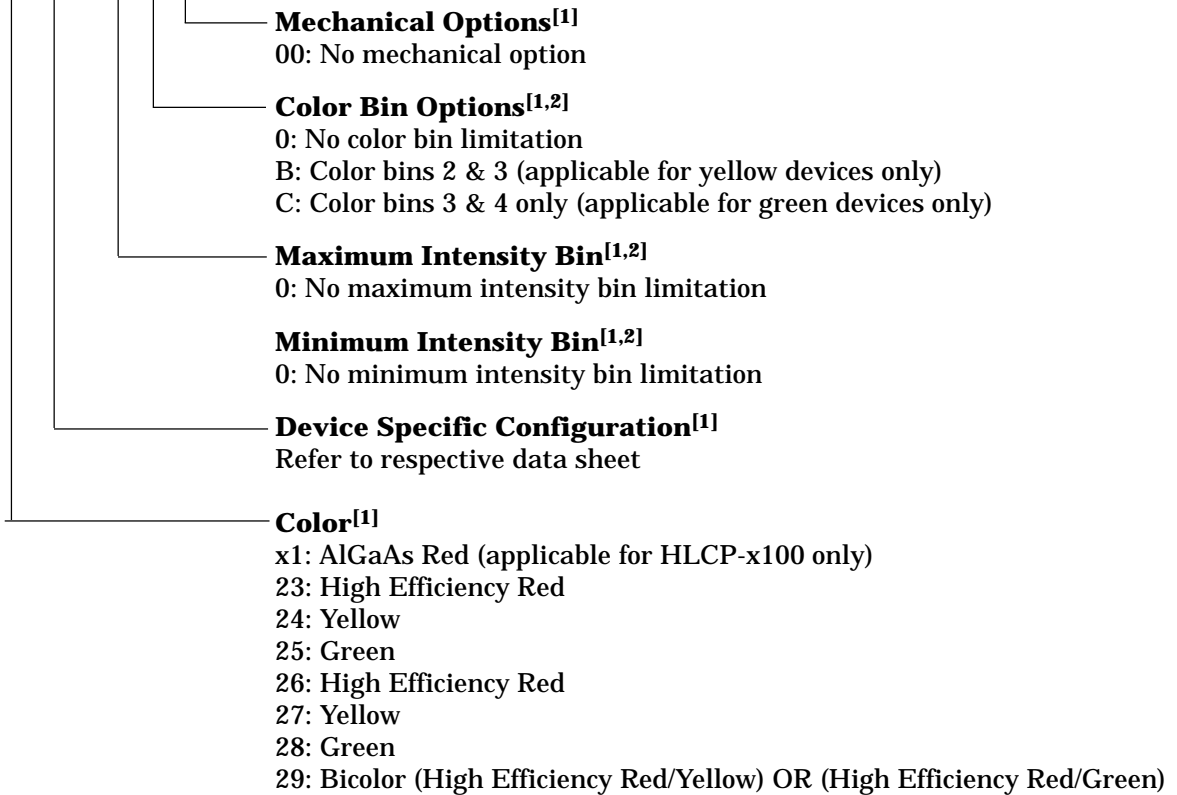

Notes:

1. For codes not listed in the figure above, please refer to the respective data sheet or contact your nearest Avago representative for details.
2. Bin options refer to shippable bins for a part-number. Color and Intensity Bins are typically restricted to 1 bin per tube (exceptions may apply). Please refer to respective data sheet for specific bin limit information.

Package Dimensions

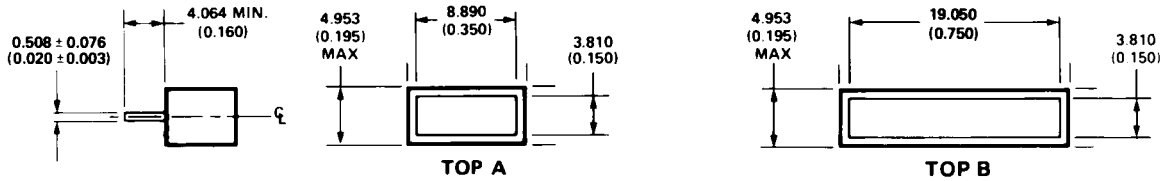

END VIEW A, B

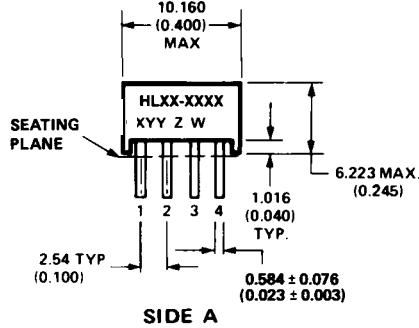

SIDE A

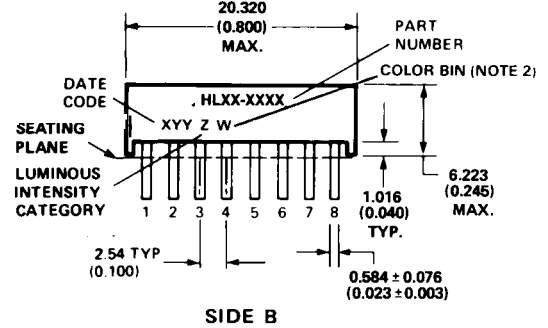

SIDE B

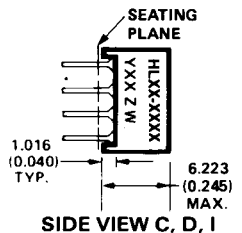

SIDE VIEW C, D, I

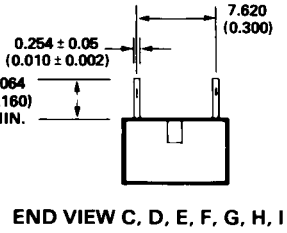
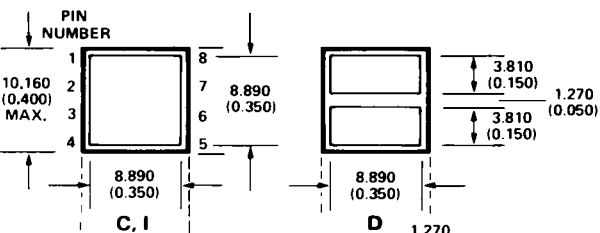

END VIEW C, D, E, F, G, H, I

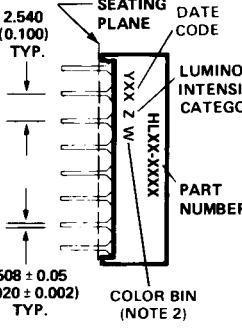

SIDE VIEW E, F, G, H

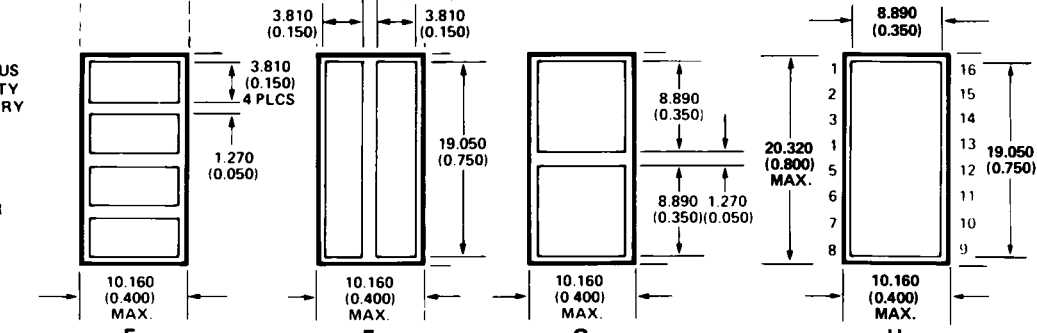

- NOTES:**
1. DIMENSIONS IN MILLIMETRES (INCHES). TOLERANCES ±0.25 mm (±0.010 IN.) UNLESS OTHERWISE INDICATED.
2. FOR YELLOW AND GREEN DEVICES ONLY.
1. DIMENSIONS IN MILLIMETRES (INCHES). TOLERANCES ±0.25 mm (±0.010 IN.) UNLESS OTHERWISE INDICATED.
2. FOR YELLOW AND GREEN DEVICES ONLY.

Internal Circuit Diagrams

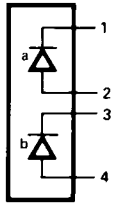

A

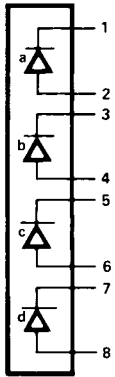

B

PIN FUNCTION		
PIN	A	B
	-2300/-2400 -2500/A100	-2350/-2450 -2550/B100
1	CATHODE a	CATHODE a
2	ANODE a	ANODE a
3	CATHODE b	CATHODE b
4	ANODE b	ANODE b
5		CATHODE c
6		ANODE c
7		CATHODE d
8		ANODE d

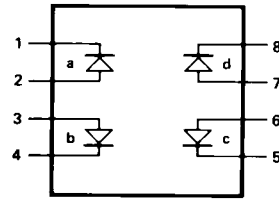

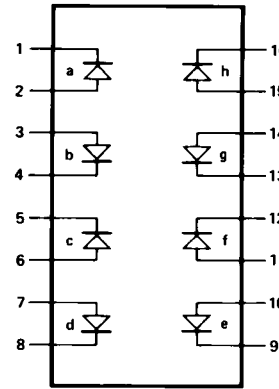

C,D

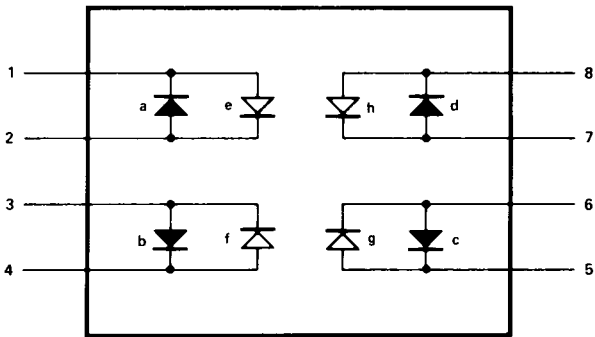

E,F,G,H

PIN	PIN FUNCTION	
	C, D	E, F, G, H
1	CATHODE a	CATHODE a
2	ANODE a	ANODE a
3	ANODE b	ANODE b
4	CATHODE b	CATHODE b
5	CATHODE c	CATHODE c
6	ANODE c	ANODE c
7	ANODE d	ANODE d
8	CATHODE d	CATHODE d
9		CATHODE e
10		ANODE e
11		ANODE f
12		CATHODE f
13		CATHODE g
14		ANODE g
15		ANODE h
16		CATHODE h



 HIGH EFFICIENCY RED LED
  YELLOW OR GREEN LED

I

PIN	PIN FUNCTION	
	HER	YELLOW/ GREEN
1	CATHODE a	ANODE e
2	ANODE a	CATHODE e
3	ANODE b	CATHODE f
4	CATHODE b	ANODE f
5	CATHODE c	ANODE g
6	ANODE c	CATHODE g
7	ANODE d	CATHODE h
8	CATHODE d	ANODE h

Absolute Maximum Ratings

Parameter	AlGaAs Red HLCP-X100 Series	HER HLMP-2300/ 2600/29XX Series	Yellow HLMP-2400/ 2700/2950 Series	Green HLMP-2500/ 2800/2965 Series
Average Power Dissipated per LED Chip	37 mW ^[1]	135 mW ^[2]	85 mW ^[3]	135 mW ^[2]
Peak Forward Current per LED Chip	45 mA ^[4]	90 mA ^[5]	60 mA ^[5]	90 mA ^[5]
Average Forward Current per LED Chip	15 mA	25 mA	20 mA	25 mA
DC Forward Current per LED Chip	15 mA ^[1]	30 mA ^[2]	25 mA ^[3]	30 mA ^[2]
Reverse Voltage per LED Chip	5 V	6 V ^[6]		
Operating Temperature Range	-20°C to +100°C ^[7]	-40°C to +85°C		-20°C to +85°C
Storage Temperature Range	-40°C to +85°C			
Wave Soldering Temperature 1.6 mm (1/16 inch) below Body	250°C for 3 seconds			

Notes:

- Derate above 87°C at 1.7 mW/°C per LED chip. For DC operation, derate above 91°C at 0.8 mA/°C.
- Derate above 25°C at 1.8 mW/°C per LED chip. For DC operation, derate above 50°C at 0.5 mA/°C.
- Derate above 50°C at 1.8 mW/°C per LED chip. For DC operation, derate above 60°C at 0.5 mA/°C.
- See Figure 1 to establish pulsed operation. Maximum pulse width is 1.5 mS.
- See Figure 6 to establish pulsed operation. Maximum pulse width is 2 mS.
- Does not apply to bicolor parts.
- For operation below -20°C, contact your local Avago sales representative.

Electrical/Optical Characteristics at T_A = 25°C AlGaAs Red HLCP-X100 Series

Parameter	HLCP-	Symbol	Min.	Typ.	Max.	Units	Test Conditions
Luminous Intensity per Lighting Emitting Area ^[1]	A100/D100/E100	I _V	3	7.5		mcd	I _F = 3 mA
	B100/C100/F100/G100		6	15		mcd	
	H100		12	30		mcd	
Peak Wavelength		λ _{PEAK}		645		nm	
Dominant Wavelength ^[2]		λ _d		637		nm	
Forward Voltage per LED		V _F		1.8	2.2	V	I _F = 20 mA
Reverse Breakdown Voltage per LED		V _R	5	15		V	I _R = 100 μA
Thermal Resistance LED Junction-to-Pin		Rθ _{J-PIN}		250		°C/W/ LED	

High Efficiency Red HLMP-2300/2600/2900 Series

Parameter	HLMP-	Symbol	Min.	Typ.	Max.	Units	Test Conditions
Luminous Intensity per Lighting Emitting Area ^[1]	2300/2600/2620	I_V	6	23		mcd	$I_F = 20 \text{ mA}$
	2350/2635/2655/2670/2950 ^[3]		13	45		mcd	
	2965 ^[4]		19	45		mcd	
	2685		22	80		mcd	
Peak Wavelength		λ_{PEAK}		635		nm	
Dominant Wavelength ^[2]		λ_d		626		nm	
Forward Voltage per LED		V_F		2.0	2.6	V	$I_F = 20 \text{ mA}$
Reverse Breakdown Voltage per LED ^[5]		V_R	6	15		V	$I_R = 100 \mu\text{A}$
Thermal Resistance LED Junction-to-Pin		$R\theta_{\text{J-PIN}}$		150		°C/W/LED	

Yellow HLMP-2400/2700/2950 Series

Parameter	HLMP-	Symbol	Min.	Typ.	Max.	Units	Test Conditions
Luminous Intensity per Lighting Emitting Area ^[1]	2400/2700/2720	I_V	6	20		mcd	$I_F = 20 \text{ mA}$
	2450/2735/2755/2770/2950 ^[3]		13	38		mcd	
	2785		26	70		mcd	
Peak Wavelength		λ_{PEAK}		583		nm	
Dominant Wavelength ^[2]		λ_d		585		nm	
Forward Voltage per LED		V_F		2.1	2.6	V	$I_F = 20 \text{ mA}$
Reverse Breakdown Voltage per LED ^[5]		V_R	6	15		V	$I_R = 100 \mu\text{A}$
Thermal Resistance LED Junction-to-Pin		$R\theta_{\text{J-PIN}}$		150		°C/W/LED	

High Performance Green HLMP-2500/2800/2965 Series

Parameter	HLMP-	Symbol	Min.	Typ.	Max.	Units	Test Conditions
Luminous Intensity per Lighting Emitting Area ^[1]	2500/2800/2820	I_V	5	25		mcd	$I_F = 20 \text{ mA}$
	2550/2835/2855/2870		11	50		mcd	
	2965 ^[4]		25	50		mcd	
	2885		22	100		mcd	
Peak Wavelength		λ_{PEAK}		565		nm	
Dominant Wavelength ^[2]		λ_d		572		nm	
Forward Voltage per LED		V_F		2.2	2.6	V	$I_F = 20 \text{ mA}$
Reverse Breakdown Voltage per LED ^[5]		V_R	6	15		V	$I_R = 100 \mu\text{A}$
Thermal Resistance LED Junction-to-Pin		$R\theta_{\text{J-PIN}}$		150		°C/W/ LED	

Notes:

1. These devices are categorized for luminous intensity. The intensity category is designated by a letter code on the side of the package.
2. The dominant wavelength, λ_d , is derived from the CIE chromaticity diagram and is the single wavelength which defines the color of the device. Yellow and Green devices are categorized for dominant wavelength with the color bin designated by a number code on the side of the package.
3. This is an HER/Yellow bicolor light bar. HER electrical/optical characteristics are shown in the HER table. Yellow electrical/optical characteristics are shown in the Yellow table.
4. This is an HER/Green bicolor light bar. HER electrical/optical characteristics are shown in the HER table. Green electrical/optical characteristics are shown in the Green table.
5. Does not apply to HLMP-2950 or HLMP-2965.

AlGaAs Red

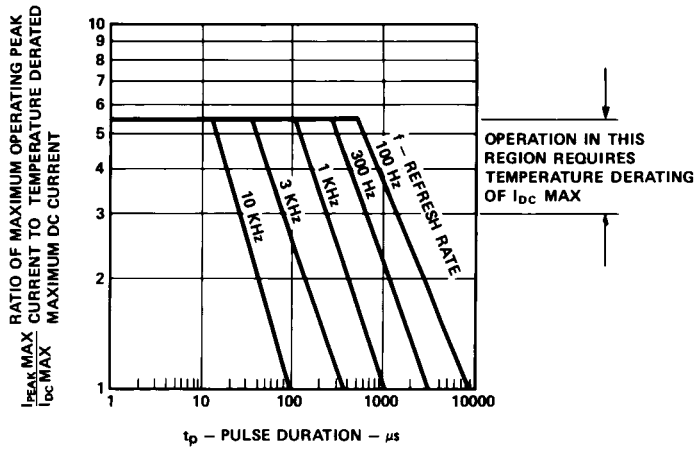

Figure 1. Maximum Allowable Peak Current vs. Pulse Duration.

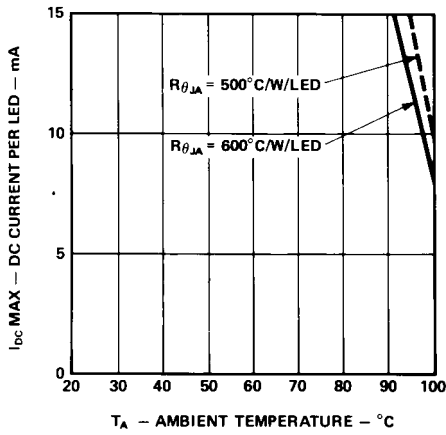

Figure 2. Maximum Allowed DC Current per LED vs. Ambient Temperature, $T_{J,MAX} = 110^{\circ}C$.

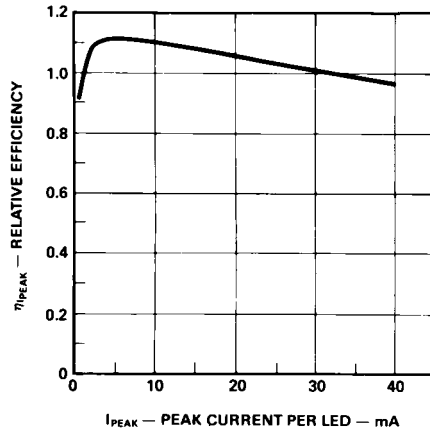

Figure 3. Relative Efficiency (Luminous Intensity per Unit Current) vs. Peak LED Current.

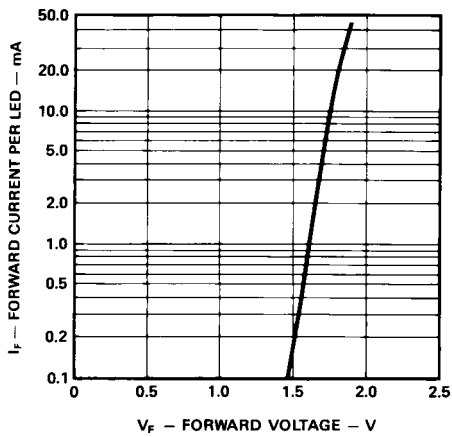

Figure 4. Forward Current vs. Forward Voltage.

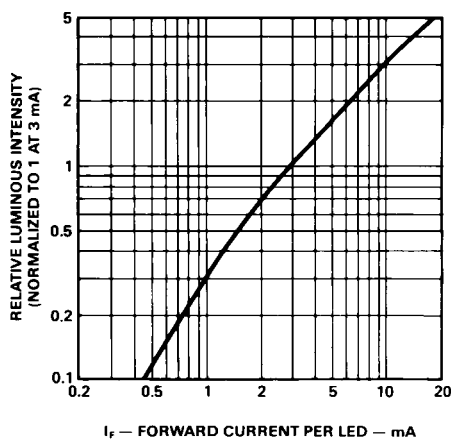

Figure 5. Relative Luminous Intensity vs. DC Forward Current.

HER, Yellow, Green

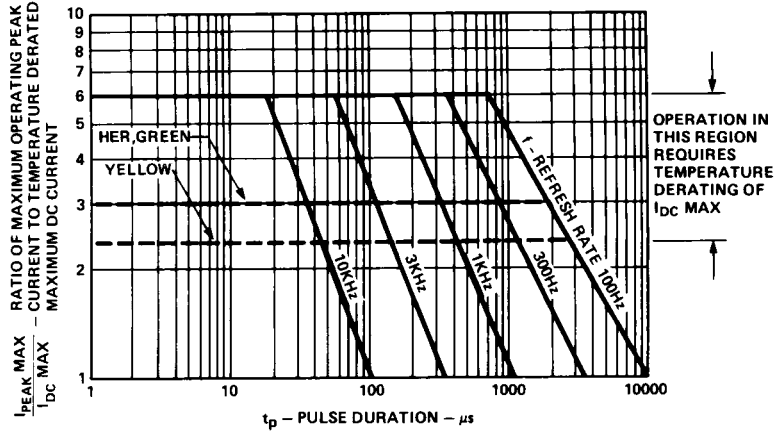

Figure 6. Maximum Allowed Peak Current vs. Pulse Duration.

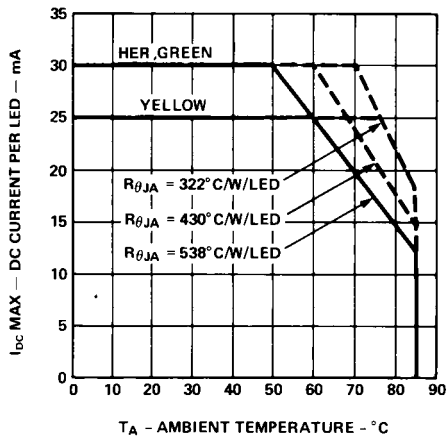

Figure 7. Maximum Allowable DC Current per LED vs. Ambient Temperature, $T_J MAX = 100^{\circ}C$.

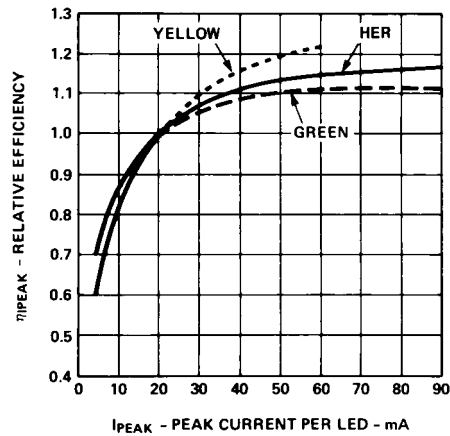

Figure 8. Relative Efficiency (Luminous Intensity per Unit Current) vs. Peak LED Current.

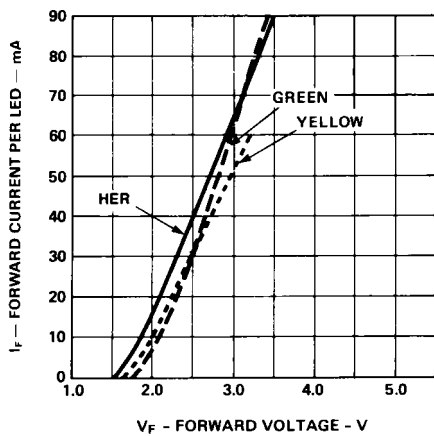

Figure 9. Forward Current vs. Forward Voltage Characteristics.

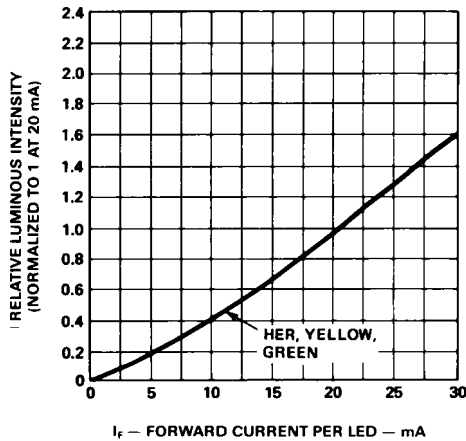

Figure 10. Relative Luminous Intensity vs. DC Forward Current.

For a detailed explanation on the use of data sheet information and recommended soldering procedures, see Application Notes 1005, 1027, and 1031.

Intensity Bin Limits (mcd)

HLMP-2300/2600/2620 Annunciators (.2 x .4 HER/AlGaAs),
HLCP-A100/D100/E100

IV Bin Category	Min.	Max.
A	3.00	5.60
B	4.50	8.20
C	6.80	12.10
D	10.10	18.50
E	15.30	27.80
F	22.80	45.50
G	36.90	73.80

Notes:
1. Minimum category A for Red L/C AlGaAs (-A100/-D100/-E100).
2. Minimum category C for HER (-2300/-2600/-2620).

HLMP-2350/2635/2655/2670 Annunciators (.2 x .8 HER/AlGaAs),
HLCP-B100/C100/F100/G100 (.4 x .4 HER/AlGaAs)

IV Bin Category	Min.	Max.
A	5.40	10.90
B	9.00	16.00
C	13.10	24.00
D	19.70	36.10
E	29.60	54.20
F	44.90	88.80
G	71.90	143.80

Notes:
1. Minimum category A for Red L/C AlGaAs (-B100/-C100/-F100/-G100).
2. Minimum category C for HER (-2350/-2635/-2670).

HLMP-2685/HLCP-H100 Annunciators (.4 x .8 HER/AlGaAs)

IV Bin Category	Min.	Max.
A	10.80	22.00
B	18.00	27.10
C	22.00	40.80
D	33.30	61.10
E	50.00	91.80
F	75.10	150.00
G	121.70	243.40

Notes:
1. Minimum category A for Red L/C AlGaAs (-H100).
2. Minimum category C for HER (-2685).

HLMP-2400/2700/2720 Annunciators (.2 x .4 Yellow)

IV Bin Category	Min.	Max.
C	6.10	11.20
D	9.20	16.80
E	13.80	25.30
F	20.70	41.40
G	33.60	67.20

HLMP-2450/2735/2755/2770 Annunciators (.2 x .8 Yellow & .4 x .4 Yellow)

IV Bin Category	Min.	Max.
C	13.00	22.00
D	18.00	33.00
E	27.00	50.00
F	40.50	81.00
G	65.60	131.20

HLMP-2785 Annunciators (.4 x .8 Yellow)

IV Bin Category	Min.	Max.
C	26.00	44.40
D	36.00	66.00
E	54.00	99.00
F	81.00	162.00
G	131.40	262.80

HLMP-2500/2800/2820 Annunciators (.2 x .4 Yellow)

IV Bin Category	Min.	Max.
C	5.60	10.20
D	8.40	15.30
E	12.60	23.10
F	18.90	37.80
G	30.60	61.20
H	49.50	97.90
I	80.10	158.40

HLMP-2550/2835/2855/2870 Annunciators (.2 x .8/.4 x .4 Green)

IV Bin Category	Min.	Max.
C	11.30	20.60
D	17.00	31.00
E	25.40	46.50
F	38.10	76.20
G	61.60	123.20
H	99.81	197.67
I	161.73	320.21

HLMP-2885 Annunciators (.4 x .8 Green)

IV Bin Category	Min.	Max.
C	22.20	40.80
D	33.40	61.20
E	50.10	91.90
F	75.10	150.30
G	121.10	242.20
H	196.10	383.50
I	313.70	613.60

HLMP-2950 Bi-Color Annunciators (.4 x .4 HER/Yellow)

IV Bin Category	Min.	Max.
Red Iv Categories		
C	11.30	20.60
D	17.00	31.00
E	25.40	46.50
F	38.10	76.20
G	61.60	123.20
Yellow Iv Categories		
C	13.00	22.00
D	18.00	33.00
E	27.00	50.00
F	40.50	81.00
G	65.60	131.20

HLMP-2965 Bi-Color Annunciators (.4 x .4/.2 x .8 HER/Green)

IV Bin Category	Min.	Max.
Red Iv Categories		
D	19.70	36.10
E	29.60	54.20
F	44.90	88.80
G	71.90	143.80
Green Iv Categories		
B	7.50	13.90
C	11.30	20.60
D	17.00	31.00
E	25.40	46.50
F	38.10	76.20
G	61.60	123.20
H	100.00	200.00
Notes: 1. Minimum category D for LPE Green (-2965). 2. In green mode, the devices are to be color binned into standard color bins, per Table 2. (-2685).		

Color Categories

Color	Bin	Dominant Wavelength (nm)	
		Min.	Max.
Yellow	0	579.0	582.5
	1	581.5	585.0
	3	584.0	587.5
	2	586.5	590.0
	4	589.0	592.5
	5	591.5	595.0
Green	2	573.00	577.00
	3	570.00	574.00
	4	567.00	571.00
	5	564.00	568.00

Note:

All categories are established for classification of products. Products may not be available in all categories. Please contact your local Avago representatives for further clarification/information.

Electrical

These light bars are composed of two, four, or eight light emitting diodes, with the light from each LED optically scattered to form an evenly illuminated light emitting surface.

The anode and cathode of each LED is brought out by separate pins. This universal pinout arrangement allows the LEDs to be connected in three possible configurations: parallel, series, or series parallel. The typical forward voltage values can be scaled from Figures 4 and 9. These values should be used to calculate the current limiting resistor value and typical power consumption. Expected maximum V_F values for driver circuit design and maximum power dissipation,

may be calculated using the following V_{FMAX} models:

AlGaAs Red HLCP-X100 series

$$V_{FMAX} = 1.8 \text{ V} + I_{PEAK} (20 \Omega)$$

For: $I_{PEAK} \leq 20 \text{ mA}$

$$V_{FMAX} = 2.0 \text{ V} + I_{PEAK} (10 \Omega)$$

For: $20 \text{ mA} \leq I_{PEAK} \leq 45 \text{ mA}$

HER (HLMP-2300/2600/2900),
Yellow (HLMP-2400/2700/2900)
and Green (HLMP-2500/2800/
2900) series

$$V_{FMAX} = 1.6 + I_{PEAK} (50 \Omega)$$

For: $5 \text{ mA} \leq I_{PEAK} \leq 20 \text{ mA}$

$$V_{FMAX} = 1.8 + I_{PEAK} (40 \Omega)$$

For: $I_{PEAK} \geq 20 \text{ mA}$

The maximum power dissipation can be calculated for any pulsed or DC drive condition. For DC operation, the maximum power

dissipation is the product of the maximum forward voltage and the maximum forward current. For pulsed operation, the maximum power dissipation is the product of the maximum forward voltage at the peak forward current times the maximum average forward current. Maximum allowable power dissipation for any given ambient temperature and thermal resistance ($R_{\theta JA}$) can be determined by using Figure 2 or 7. The solid line in Figure 2 or 7 ($R_{\theta JA}$ of 600/538 C/W) represents a typical thermal resistance of a device socketed in a printed circuit board. The dashed lines represent achievable thermal resistances that can be obtained through improved thermal design. Once the maximum allowable power dissipation is determined, the maximum pulsed or DC forward current can be calculated.

Optical

Size of Light Emitting Area	Surface Area	
	Sq. Metres	Sq. Feet
8.89 mm x 8.89 mm	67.74×10^{-6}	729.16×10^{-6}
8.89 mm x 3.81 mm	33.87×10^{-6}	364.58×10^{-6}
8.89 mm x 19.05 mm	135.48×10^{-6}	1458.32×10^{-6}
3.81 mm x 19.05 mm	72.85×10^{-6}	781.25×10^{-6}

The radiation pattern for these light bar devices is approximately Lambertian. The luminous sterance may be calculated using one of the two following formulas:

$$L_v \text{ (cd/m}^2\text{)} = \frac{I_v \text{ (cd)}}{A \text{ (m}^2\text{)}}$$

$$L_v \text{ (footlamberts)} = \frac{\pi I_v \text{ (cd)}}{A \text{ (ft}^2\text{)}}$$

Refresh rates of 1 kHz or faster provide the most efficient operation resulting in the maximum possible time average luminous intensity.

The time average luminous intensity may be calculated using the relative efficiency characteristic of Figure 3 or 8, ηI_{PEAK} , and adjusted for operating ambient temperature. The time average luminous intensity at $T_A = 25^\circ\text{C}$ is calculated as follows:

$$I_{v \text{ TIME AVG}} = \left[\frac{I_{AVG}}{I_{TEST}} \right] (\eta I_{PEAK}) (I_v \text{ Data Sheet})$$

where:

$I_{TEST} = 3 \text{ mA}$ for AlGaAs Red (HLMP-X000 series)
20 mA for HER, Yellow and Green (HLMP-2XXX series)

Example:

For HLMP-2735 series

$$\eta I_{PEAK} = 1.18 \text{ at } I_{PEAK} = 48 \text{ mA}$$

$$I_{v \text{ TIME AVG}} = \left[\frac{12 \text{ mA}}{20 \text{ mA}} \right] (1.18) (35 \text{ mcd}) = 25 \text{ mcd}$$

The time average luminous intensity may be adjusted for operating ambient temperature by the following exponential equation:

$$I_v(T_A) = I_v(25^\circ\text{C})e^{[K(T_A - 25^\circ\text{C})]}$$

Color	K
AlGaAs Red	-0.0095/°C
HER	-0.0131/°C
Yellow	-0.0112/°C
Green	-0.0104/°C

Example:

$$I_v(80^\circ\text{C}) = (25 \text{ mcd})e^{[-0.0112(80-25)]}$$

$$= 14 \text{ mcd.}$$

Mechanical

These light bar devices may be operated in ambient temperatures above + 60°C without derating when installed in a PC board configuration that provides a thermal resistance pin to ambient value less than 280°C/W/LED. See Figure 2 or 7 to determine the maximum allowed thermal resistance for the PC board, $R_{\theta_{PC-A}}$, which will permit nonderated operation in a given ambient temperature.

To optimize device optical performance, specially developed plastics are used which restrict the solvents that may be used for cleaning. It is recommended that only mixtures of Freon (F113) and alcohol be used for vapor cleaning processes, with an

immersion time in the vapors of less than two (2) minutes maximum. Some suggested vapor cleaning solvents are Freon TE, Genesolv DES, Arklone A or K. A 60°C (140°F) water cleaning process may also be used, which includes a neutralizer rinse (3% ammonia solution or equivalent), a surfactant rinse (1% detergent solution or equivalent), a hot water rinse and a thorough air dry. Room temperature cleaning may be accomplished with Freon T-E35 or T-P35, Ethanol, Isopropanol or water with a mild detergent.

For further information on soldering LEDs please refer to Application Note 1027.

For product information and a complete list of distributors, please go to our website: www.avagotech.com

Avago, Avago Technologies, and the A logo are trademarks of Avago Technologies Limited in the United States and other countries. Data subject to change. Copyright © 2006 Avago Technologies Limited. All rights reserved. Obsoletes 5988-2221EN AV01-0692EN December 9, 2006

AVAGO
TECHNOLOGIES