

---

## LOW VOLTAGE DETECTOR WITH OUTPUT DELAY

---

NO. EA-087-090422

### OUTLINE

The R3112x Series are CMOS-based voltage detector ICs with high detector threshold accuracy and ultra-low supply current, which can be operated at an extremely low voltage and is used for system reset as an example.

Each of these ICs consists of a voltage reference unit, a comparator, resistor net for detector threshold setting, an output driver, a hysteresis circuit, and an output delay circuit. The detector threshold is fixed with high accuracy internally and does not require any adjustment. Two output types, Nch open drain type and CMOS type are available.

Three types of packages, SOT-23-5, small SC-82AB, SC-88A and ultra-small SON1612-6 can be selected so that high density mounting on boards is possible.

### FEATURES

- Built-in Output Delay Circuit..... Typ. 100ms with an external capacitor: 0.022 $\mu$ F
- Supply Current..... Typ. 0.5 $\mu$ A (R3112x271A/C,  $V_{DD}$ =2.6V)
- Operating Voltage ..... 0.7 to 6.0V( $T_{opt}$ =25°C)
- Detector Threshold..... 0.9V to 5.0V
- High Accuracy Detector Threshold .....  $\pm$ 2.0%
- Low Temperature-Drift Coefficient of Detector Threshold...Typ.  $\pm$ 100ppm/°C
- Two Output Types..... Nch Open Drain and CMOS
- Packages ..... SOT-23-5(Mini-mold), SC-82AB, SC-88A, SON1612-6

### APPLICATIONS

- CPU and Logic Circuit Reset
- Battery Checker
- Window Comparator
- Wave Shaping Circuit
- Battery Back-up Circuit
- Power Failure Detector

## BLOCK DIAGRAMS

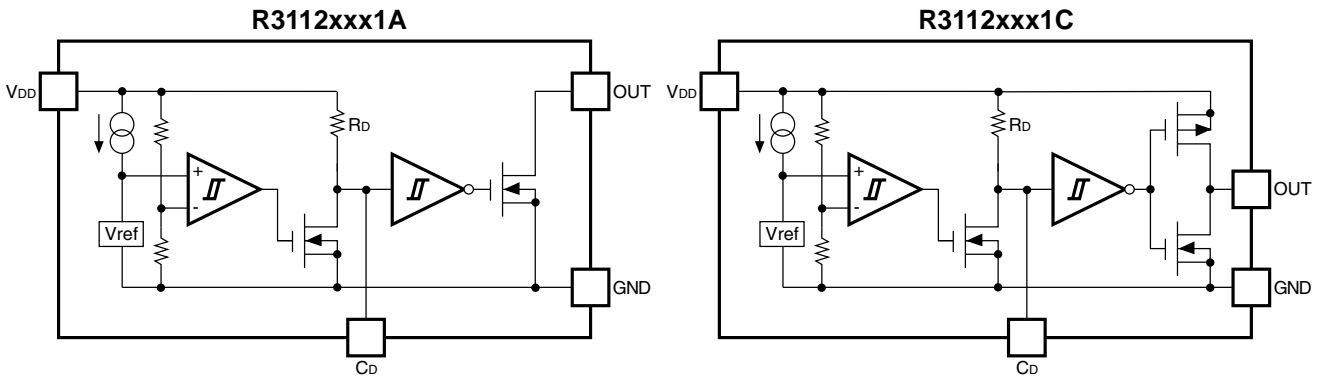

## SELECTION GUIDE

The package type, the detector threshold, the output type, and the taping type of R3112x Series can be designated at the users' request by specifying the part number as follows:

R3112xxxxx-xx-x ← Part Number  
 ↑↑↑↑↑ ↑ ↑  
 a b c d e f

Code	Contents
a	Designation of Package Type; R3112Dxx1x: SON1612-6 R3112Nxx1x: SOT-23-5 R3112Qxx1x: SC-82AB R3112Qxx2x: SC-88A
b	Setting Detector Threshold ( $-V_{DET}$ ); Stepwise setting with a step of 0.1V in the range of 0.9V to 5.0V is possible.
c	Designation of Package Type 1: except SC-88A 2: SC-88A
d	Designation of Output Type; A: Nch Open Drain C: CMOS
e	Designation of Packing or Taping Type; Ex. SOT-23-5, SC-82AB, SC-88A, SON1612-6: TR is prescribed as standard directions. (Refer to Taping Specifications)
	Designation of Composition of pin plating; -F: Lead free plating (SOT-23-5, SC-82AB, SC-88A, SON1612-6)

## PIN CONFIGURATION

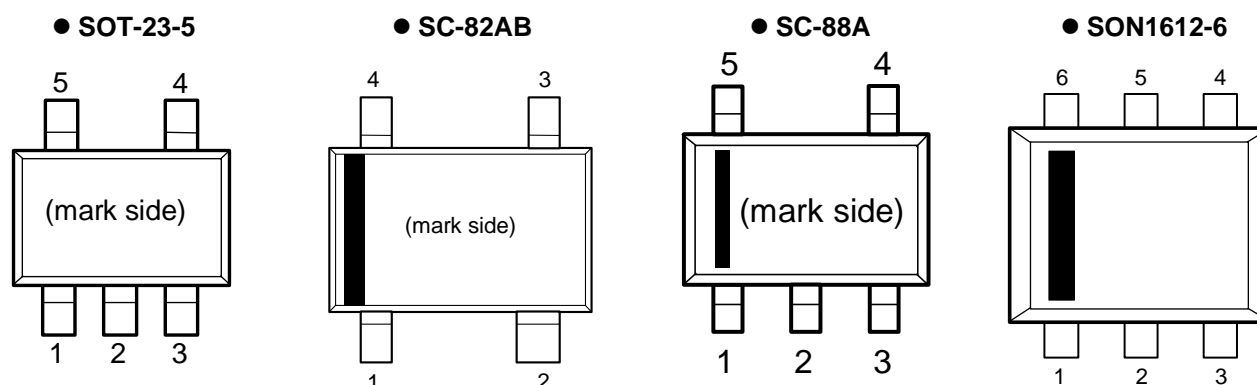

## PIN DESCRIPTION

### • SOT-23-5

Pin No.	Symbol	Description
1	OUT	Output Pin (Output "L" at detector threshold, Output "H" at released voltage)
2	V <sub>DD</sub>	Voltage Supply Pin
3	GND	Ground Pin
4	NC	No Connection
5	C <sub>D</sub>	Pin for External Capacitor (for setting output delay)

### •SC-82AB

Pin No.	Symbol	Description
1	V <sub>DD</sub>	Voltage Supply Pin
2	GND	Ground Pin
3	C <sub>D</sub>	Pin for External Capacitor (for setting output delay)
4	OUT	Output Pin (Output "L" at detector threshold, Output "H" at released voltage)

### • SC-88A

Pin No.	Symbol	Description
1	V <sub>DD</sub>	Voltage Supply Pin
2	NC	No Connection
3	GND	Ground Pin
4	C <sub>D</sub>	Pin for External Capacitor (for setting output delay)
5	OUT	Output Pin (Output "L" at detector threshold, Output "H" at released voltage)

### •SON1612-6

Pin No.	Symbol	Description
1	OUT	Output Pin (Output "L" at detector threshold, Output "H" at released voltage)
2	GND	Ground Pin
3	C <sub>D</sub>	Pin for External Capacitor (for setting output delay)
4	NC	No Connection
5	GND	Ground Pin
6	V <sub>DD</sub>	Voltage Supply Pin

## ABSOLUTE MAXIMUM RATINGS

Symbol	Item	Rating	Unit
$V_{DD}$	Supply Voltage	6.5	V
$V_{OUT1}$	Output Voltage (CMOS)	$V_{SS}-0.3$ to $V_{DD}+0.3$	V
$V_{OUT2}$	Output Voltage (Nch)	$V_{SS}-0.3$ to 6.5	V
$I_{OUT}$	Output Current	20	mA
$P_D$	Power Dissipation (SOT-23-5)*	420	mW
	Power Dissipation (SC-82AB)*	380	
	Power Dissipation (SC-88A)*	380	
	Power Dissipation (SON1612-6)*	500	
$T_{opt}$	Operating Temperature Range	-40 to 85	°C
$T_{stg}$	Storage Temperature Range	-55 to 125	°C
$T_{solder}$	Lead temperature (Soldering)	260°C, 10s	

\* ) For Power Dissipation, please refer to PACKAGE INFORMATION.

### ABSOLUTE MAXIMUM RATINGS

Electronic and mechanical stress momentarily exceeded absolute maximum ratings may cause the permanent damages and may degrade the life time and safety for both device and system using the device in the field. The functional operation at or over these absolute maximum ratings is not assured.

## ELECTRICAL CHARACTERISTICS

### • R3112x091A/C

T<sub>opt</sub>=25°C

Symbol	Item	Conditions	Min.	Typ.	Max.	Unit
-V <sub>DET</sub>	Detector Threshold		0.882	0.900	0.918	V
V <sub>HYS</sub>	Detector Threshold Hysteresis		0.027	0.045	0.063	V
I <sub>SS</sub>	Supply Current	V <sub>DD</sub> =0.80V		0.6	2.0	μA
		V <sub>DD</sub> =1.90V		0.5	2.0	
V <sub>DDH</sub>	Maximum Operating Voltage				6.0	V
V <sub>DDL</sub>	Minimum Operating Voltage*Note1	T <sub>opt</sub> =25°C			0.70	V
		-40°C ≤ T <sub>opt</sub> ≤ 85°C			0.80	
I <sub>OUT</sub>	Output Current (Driver Output Pin)	Nch	10	120		μA
		V <sub>DS</sub> =0.05V, V <sub>DD</sub> =0.70V	0.05	0.90		mA
		V <sub>DS</sub> =0.50V, V <sub>DD</sub> =0.85V				
		Pch	1.0	3.5		mA
		V <sub>DS</sub> =-2.1V, V <sub>DD</sub> =4.5V				
V <sub>TCD</sub>	CD pin Threshold Voltage	V <sub>DD</sub> =0.99V	0.297	0.495	0.693	V
I <sub>CD</sub>	CD pin Output Current	V <sub>DS</sub> =0.10V, V <sub>DD</sub> =0.70V	2	70		μA
		V <sub>DS</sub> =0.50V, V <sub>DD</sub> =0.85V	10	400		
R <sub>D</sub>	Output Delay Resistance		3.25	6.50	13.00	MΩ
Δ-V <sub>DET</sub> / ΔT <sub>opt</sub>	Detector Threshold Temperature Coefficient	-40°C ≤ T <sub>opt</sub> ≤ 85°C		±100		ppm/ °C

### RECOMMENDED OPERATING CONDITIONS (ELECTRICAL CHARACTERISTICS)

All of electronic equipment should be designed that the mounted semiconductor devices operate within the recommended operating conditions. The semiconductor devices cannot operate normally over the recommended operating conditions, even if when they are used over such conditions by momentary electronic noise or surge. And the semiconductor devices may receive serious damage when they continue to operate over the recommended operating conditions.

**R3112x**• **R3112x271A/C**T<sub>opt</sub>=25°C

Symbol	Item	Conditions	Min.	Typ.	Max.	Unit
-V <sub>DET</sub>	Detector Threshold		2.646	2.700	2.754	V
V <sub>HYS</sub>	Detector Threshold Hysteresis		0.081		0.189	V
I <sub>SS</sub>	Supply Current	V <sub>DD</sub> =2.60V		1.0	3.0	μA
		V <sub>DD</sub> =3.70V		0.5	2.5	
V <sub>DDH</sub>	Maximum Operating Voltage				6.0	V
V <sub>DDL</sub>	Minimum Operating Voltage <sup>*Note1</sup>	T <sub>opt</sub> =25°C			0.7	V
		-40°C ≤ T <sub>opt</sub> ≤ 85°C			0.8	
I <sub>OUT</sub>	Output Current (Driver Output Pin)	Nch V <sub>DS</sub> =0.05V, V <sub>DD</sub> =0.70V	10	120		μA
		V <sub>DS</sub> =0.50V, V <sub>DD</sub> =1.50V	1.0	3.0		mA
		Pch V <sub>DS</sub> =-2.1V, V <sub>DD</sub> =4.5V	1.0	3.5		mA
V <sub>TCD</sub>	CD pin Threshold Voltage	V <sub>DD</sub> =2.97V	0.891	1.485	2.079	V
I <sub>CD</sub>	CD pin Output Current	V <sub>DS</sub> =0.1V, V <sub>DD</sub> =0.7V	2	70		μA
		V <sub>DS</sub> =0.5V, V <sub>DD</sub> =1.5V	200	500		
R <sub>D</sub>	Output Delay Resistance		3.25	6.50	13.00	MΩ
Δ-V <sub>DET</sub> / ΔT <sub>opt</sub>	Detector Threshold Temperature Coefficient	-40°C ≤ T <sub>opt</sub> ≤ 85°C		±100		ppm/ °C

## ● R3112x501A/C

T<sub>opt</sub>=25°C

Symbol	Item	Conditions	Min.	Typ.	Max.	Unit
-V <sub>DET</sub>	Detector Threshold		4.900	5.000	5.100	V
V <sub>HYS</sub>	Detector Threshold Hysteresis		0.150	0.250	0.350	V
I <sub>SS</sub>	Supply Current	V <sub>DD</sub> =4.9V		1.5	3.0	μA
		V <sub>DD</sub> =6.0V		0.6	2.5	
V <sub>DDH</sub>	Maximum Operating Voltage				6.0	V
V <sub>DDL</sub>	Minimum Operating Voltage <sup>*Note1</sup>	T <sub>opt</sub> =25°C			0.7	V
		-40°C ≤ T <sub>opt</sub> ≤ 85°C			0.8	
I <sub>OUT</sub>	Output Current (Driver Output Pin)	Nch V <sub>DS</sub> =0.05V, V <sub>DD</sub> =0.70V	10	120		μA
		V <sub>DS</sub> =0.50V, V <sub>DD</sub> =1.50V	1.0	3.0		mA
		Pch V <sub>DS</sub> =-2.1V, V <sub>DD</sub> =6.0V	1.5	4.5		mA
V <sub>TCD</sub>	CD pin Threshold Voltage	V <sub>DD</sub> =5.50V	1.650	2.750	3.850	V
I <sub>CD</sub>	CD pin Output Current	V <sub>DS</sub> =0.1V, V <sub>DD</sub> =0.7V	2	70		μA
		V <sub>DS</sub> =0.5V, V <sub>DD</sub> =1.5V	200	500		
R <sub>D</sub>	Output Delay Resistance		3.25	6.50	13.00	MΩ
$\frac{\Delta-V_{DET}}{\Delta T_{opt}}$	Detector Threshold Temperature Coefficient	-40°C ≤ T <sub>opt</sub> ≤ 85°C		±100		ppm/ °C

\*Note1: Minimum Operating Voltage means the value of input voltage when output voltage maintains 0.1V or less. (In the case of Nch Open Drain Type, Output pin is pulled up with a resistance of 470kΩ to 5.0V.)

## ELECTRICAL CHARACTERISTICS BY DETECTOR THRESHOLD

Product Code	Detector Threshold			Hysteresis Range			Supply Current 1			Supply Current 2			Output Current 1			Output Current 2													
	-V <sub>DET</sub> [V]			V <sub>HYS</sub> [V]			I <sub>SS1</sub> [ $\mu$ A]			I <sub>SS2</sub> [ $\mu$ A]			I <sub>OUT1</sub> [mA]			I <sub>OUT2</sub> [mA]													
	Min.	Typ.	Max.	Min.	Typ.	Max.	Condi- tions	Typ.	Max.	Condi- tions	Typ.	Max.	Condi- tions	Min.	Typ.	Condi- tions	Min.	Typ.											
R3112x091A/C	0.882	0.900	0.918	0.027	0.045	0.063	V <sub>DD</sub> = -V <sub>DET</sub> -0.1V	0.6	2.0	V <sub>DD</sub> = -V <sub>DET</sub> +0.1V	0.5	2.0	V <sub>DS</sub> = 0.05V V <sub>DD</sub> = 0.7V	0.01	0.12	Nch	V <sub>DS</sub> = 0.5V V <sub>DD</sub> = 0.85V	0.05	0.9										
R3112x101A/C	0.980	1.000	1.020	0.030	0.050	0.070												0.7	2.5	0.2	1.8								
R3112x111A/C	1.078	1.100	1.122	0.033	0.055	0.077												1.0	3.0	0.5	2.5	1.0	3.0	0.6	2.5	1.2	3.0	0.6	2.5
R3112x121A/C	1.176	1.200	1.224	0.036	0.060	0.084																							
R3112x131A/C	1.274	1.300	1.326	0.039	0.065	0.091																							
R3112x141A/C	1.372	1.400	1.428	0.042	0.070	0.098																							
R3112x151A/C	1.470	1.500	1.530	0.045	0.075	0.105																							
R3112x161A/C	1.568	1.600	1.632	0.048	0.080	0.112																							
R3112x171A/C	1.666	1.700	1.734	0.051	0.085	0.119																							
R3112x181A/C	1.764	1.800	1.836	0.054	0.090	0.126																							
R3112x191A/C	1.862	1.900	1.938	0.057	0.095	0.133																							
R3112x201A/C	1.960	2.000	2.040	0.060	0.100	0.140																							
R3112x211A/C	2.058	2.100	2.142	0.063	0.105	0.147																							
R3112x221A/C	2.156	2.200	2.244	0.066	0.110	0.154																							
R3112x231A/C	2.254	2.300	2.346	0.069	0.115	0.161																							
R3112x241A/C	2.352	2.400	2.448	0.072	0.120	0.168																							
R3112x251A/C	2.450	2.500	2.550	0.075	0.125	0.175																							
R3112x261A/C	2.548	2.600	2.652	0.078	0.130	0.182																							
R3112x271A/C	2.646	2.700	2.754	0.081	0.135	0.189																							
R3112x281A/C	2.744	2.800	2.856	0.084	0.140	0.196																							
R3112x291A/C	2.842	2.900	2.958	0.087	0.145	0.203																							
R3112x301A/C	2.940	3.000	3.060	0.090	0.150	0.210																							
R3112x311A/C	3.038	3.100	3.162	0.093	0.155	0.217																							
R3112x321A/C	3.136	3.200	3.264	0.096	0.160	0.224																							
R3112x331A/C	3.234	3.300	3.366	0.099	0.165	0.231																							
R3112x341A/C	3.332	3.400	3.468	0.102	0.170	0.238																							
R3112x351A/C	3.430	3.500	3.570	0.105	0.175	0.245																							
R3112x361A/C	3.528	3.600	3.672	0.108	0.180	0.252																							
R3112x371A/C	3.626	3.700	3.774	0.111	0.185	0.259																							
R3112x381A/C	3.724	3.800	3.876	0.114	0.190	0.266																							
R3112x391A/C	3.822	3.900	3.978	0.117	0.195	0.273																							
R3112x401A/C	3.920	4.000	4.080	0.120	0.200	0.280																							
R3112x411A/C	4.018	4.100	4.182	0.123	0.205	0.287																							
R3112x421A/C	4.116	4.200	4.284	0.126	0.210	0.294																							
R3112x431A/C	4.214	4.300	4.386	0.129	0.215	0.301																							
R3112x441A/C	4.312	4.400	4.488	0.132	0.220	0.308																							
R3112x451A/C	4.410	4.500	4.590	0.135	0.225	0.315																							
R3112x461A/C	4.508	4.600	4.692	0.138	0.230	0.322																							
R3112x471A/C	4.606	4.700	4.794	0.141	0.235	0.329																							
R3112x481A/C	4.704	4.800	4.896	0.144	0.240	0.336																							
R3112x491A/C	4.802	4.900	4.998	0.147	0.245	0.343																							
R3112x501A/C	4.900	5.000	5.100	0.150	0.250	0.350																							



Output Current 3			Minimum Operating Voltage				CD pin Threshold Voltage			CD pin Output Current 1			CD pin Output Current 2			Resistance for Output Delay			Detector Threshold Temperature		
I <sub>OUT3</sub> [mA]			V <sub>DDL</sub> [V]				V <sub>TCO</sub> [V]			I <sub>CD1</sub> [μA]			I <sub>CD2</sub> [μA]			R <sub>D</sub> [MΩ]			Δ-V <sub>DET</sub> / ΔT <sub>opt</sub> [ppm/°C]		
Condition	Min.	Typ.	Condition	Max.	Condition	Max.	Condition	Min.	Typ.	Max.	Condition	Min.	Typ.	Condition	Min.	Typ.	Min.	Typ.	Max.	Condition	Typ.
Pch	V <sub>DS</sub> = -2.1V V <sub>DD</sub> = 4.5V	1.5	3.5	0.7	-40°C ≧ T <sub>opt</sub> ≦ 85°C	0.8	V <sub>DD</sub> = (V <sub>DET</sub> ) ×1.1V	0.297	0.495	0.693	V <sub>DS</sub> = 0.1V V <sub>DD</sub> = 0.7V	20	70	V <sub>DS</sub> = 0.5V V <sub>DD</sub> = 0.85V	10	400	3.25	6.5	13.0	-40°C ≧ T <sub>opt</sub> ≦ 85°C	±100
								0.330	0.550	0.770											
								0.363	0.605	0.847											
								0.396	0.660	0.924				V <sub>DS</sub> = 0.5V V <sub>DD</sub> = 0.85V	50	450					
								0.429	0.715	1.001											
								0.462	0.770	1.078											
								0.495	0.825	1.155				V <sub>DS</sub> = 0.5V V <sub>DD</sub> = 1.5V	200	500					
								0.528	0.880	1.232											
								0.561	0.935	1.309											
								0.594	0.990	1.386											
								0.627	1.045	1.463											
								0.660	1.100	1.540											
								0.693	1.155	1.617											
								0.726	1.210	1.694											
								0.759	1.265	1.771											
	0.792	1.320	1.848																		
	0.825	1.375	1.925																		
	0.858	1.430	2.002																		
	0.891	1.485	2.079																		
	0.924	1.540	2.156																		
	0.957	1.595	2.233																		
	0.990	1.650	2.310																		
	1.023	1.705	2.387																		
	1.056	1.760	2.464																		
	1.089	1.815	2.541																		
	1.122	1.870	2.618																		
	1.155	1.925	2.695																		
	1.188	1.980	2.772																		
	1.221	2.035	2.849																		
	1.254	2.090	2.926																		
1.287	2.145	3.003																			
1.320	2.200	3.080																			
1.353	2.255	3.157																			
1.386	2.310	3.234																			
1.419	2.365	3.311																			
1.452	2.420	3.388																			
1.485	2.475	3.465																			
1.518	2.530	3.542																			
1.551	2.585	3.619																			
1.584	2.640	3.696																			
1.617	2.695	3.773																			
1.650	2.750	3.850																			

## OPERATION

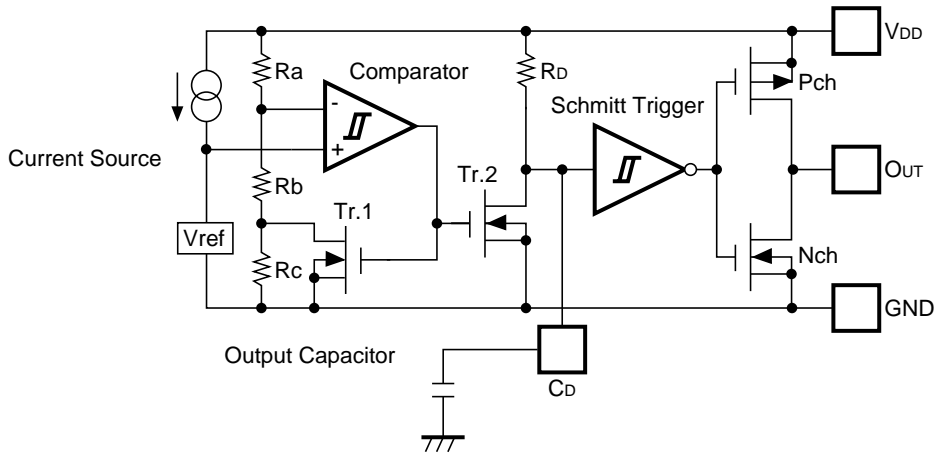

Fig. 1 Block Diagram with an external capacitor

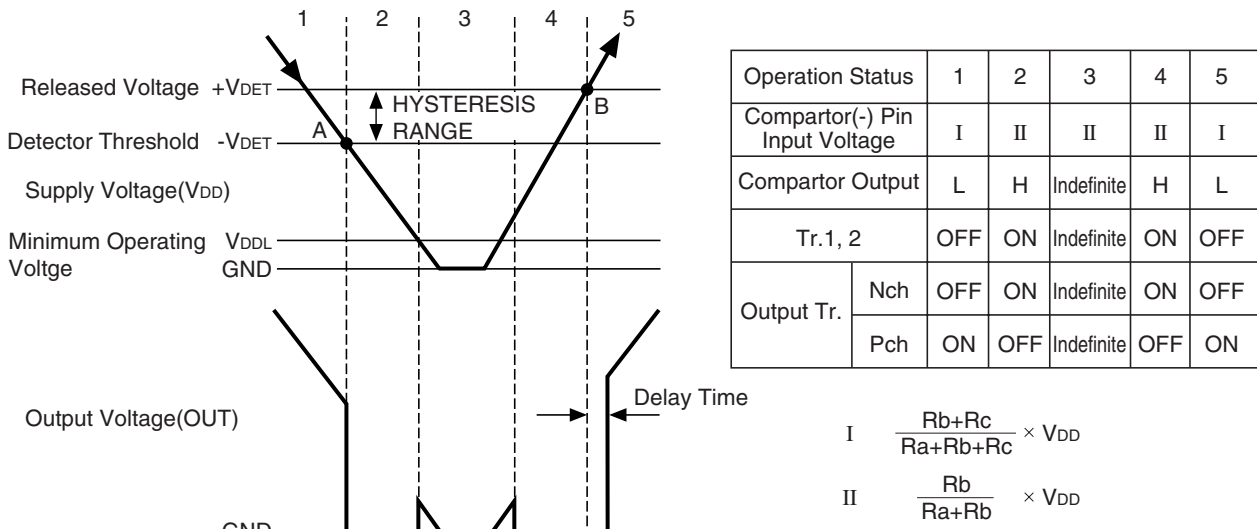
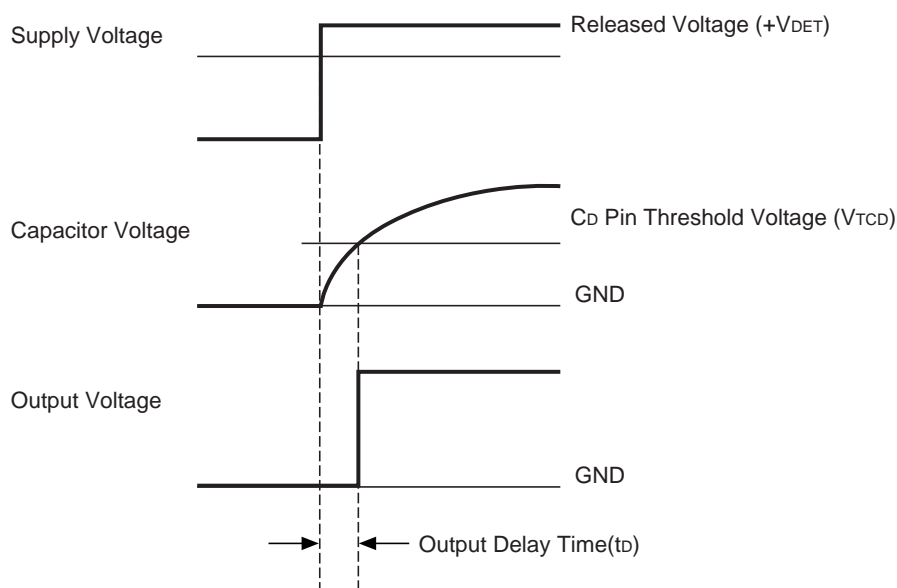

Fig. 2 Operation Diagram

1. Output voltage is equal to supply voltage. (As for Nch open drain type, equal to pull-up voltage.)
  2. When the supply voltage is down to the detector threshold voltage level(Point A),  $V_{ref} \geq V_{DD} \times (Rb+Rc) / (Ra+Rb+Rc)$  is true, then output of the comparator is reversed from “L” to “H”, therefore output voltage becomes GND level.
  3. When the supply voltage is lower than minimum operating voltage, the operation of output transistor is indefinite. In the case of Nch open drain type, output voltage is equal to pull-up voltage.
  4. Output Voltage becomes GND level.
  5. When the supply voltage is higher than released voltage (Point B),  $V_{ref} \leq V_{DD} \times Rb / (Ra+Rb)$  is true, then output of the comparator reaches the threshold level, and Output of Shmitt Trigger is reversed from “H” to “L”, then output voltage is equal to supply voltage. (As for Nch open drain type, equal to pull-up voltage.)
- \*) The difference between released voltage and detector threshold voltage means hysteresis range voltage.

### • Operation of Output Delay



When the supply voltage which is higher than released voltage is forced to  $V_{DD}$  pin, charge to an external capacitor starts, then capacitor voltage increases. Until the capacitor voltage reaches to  $C_D$  pin threshold voltage, output voltage maintains "L". When the capacitor voltage becomes higher than  $C_D$  pin threshold voltage, output voltage is reversed from "L" to "H". Where, the time interval between the rising edge of supply voltage and output voltage reverse point means output delay time.

### • Output Delay Time

Output Delay Time ( $t_D$ ) can be calculated with the next formula.

$$t_D = 0.69 \times R_D \times C_D (\text{s})$$

$R_D$  is internal resistor and set at  $6.5\text{M}\Omega$  (Typ.) typically.  $C_D$  (F) describes the capacitance value of an external capacitor. Therefore,

$$t_D = 0.69 \times 6.5 \times 10^6 \times C_D (\text{s})$$

## TEST CIRCUITS

\*Pull-up circuit is not necessary for CMOS Output type, or R3112xxxxC.

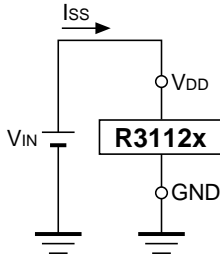

Supply Current Test Circuit

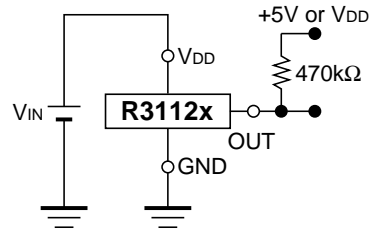

Detector Threshold Test Circuit

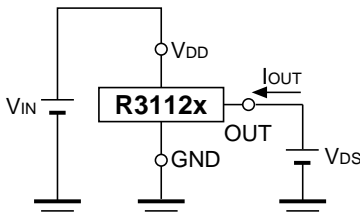

Nch Driver Output Current Test Circuit

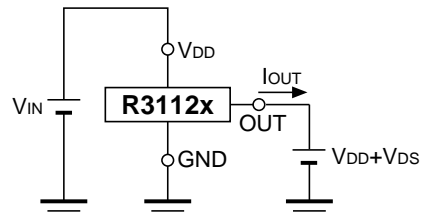

Pch Driver Output Current Test Circuit

\*Apply only to CMOS

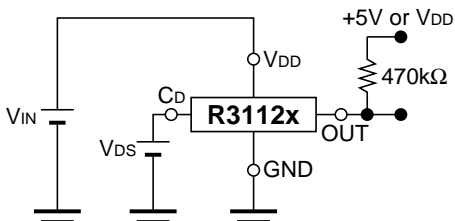

CD Pin Threshold Test Circuit

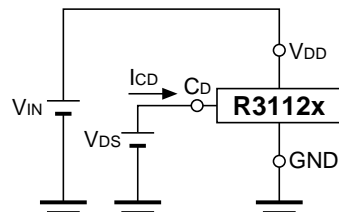

CD Pin Output Current Test Circuit

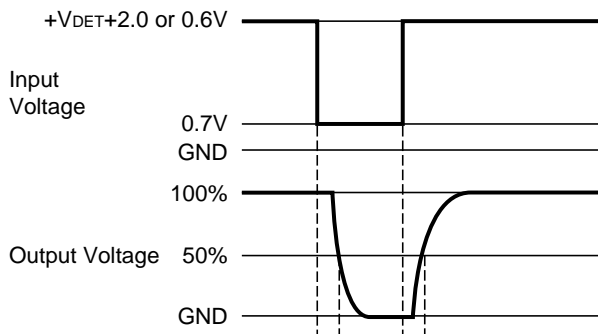

Output Delay Time Test Circuit

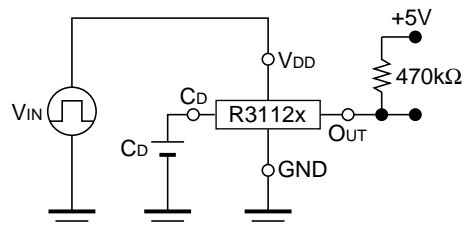

## TYPICAL CHARACTERISTICS

### 1) Supply Current vs. Input Voltage

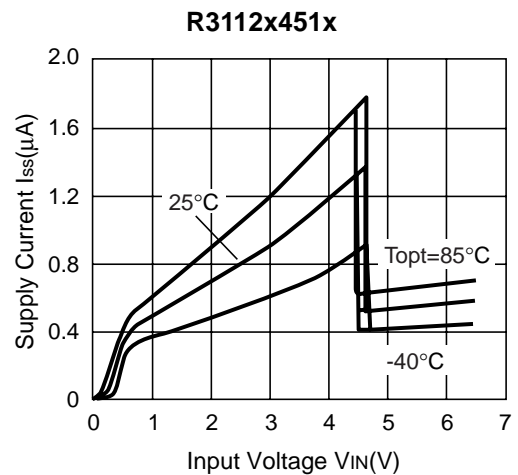
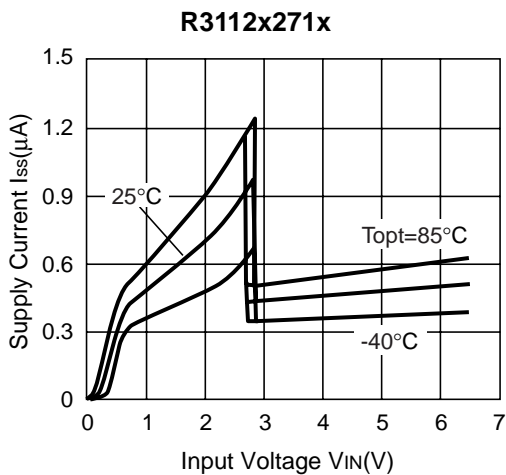
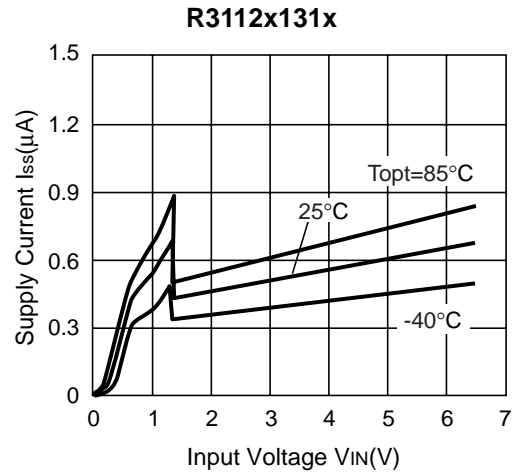
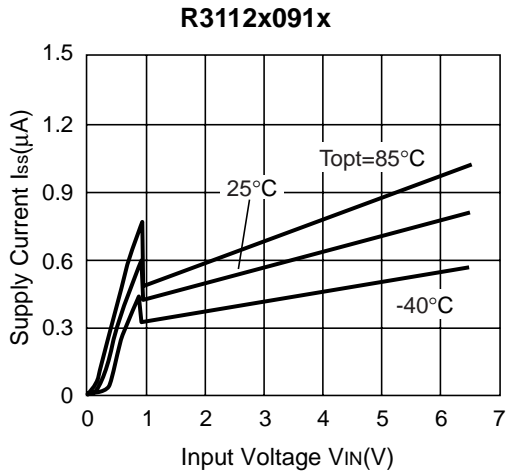

### 2) Detector Threshold vs. Temperature

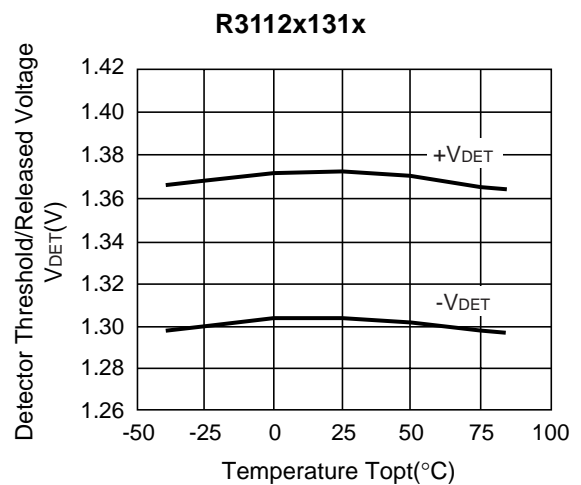
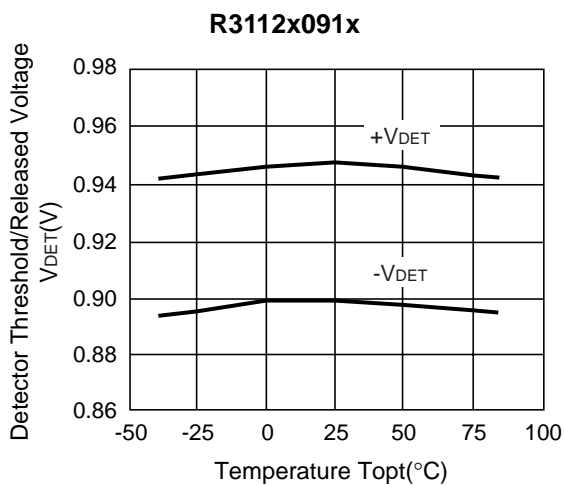

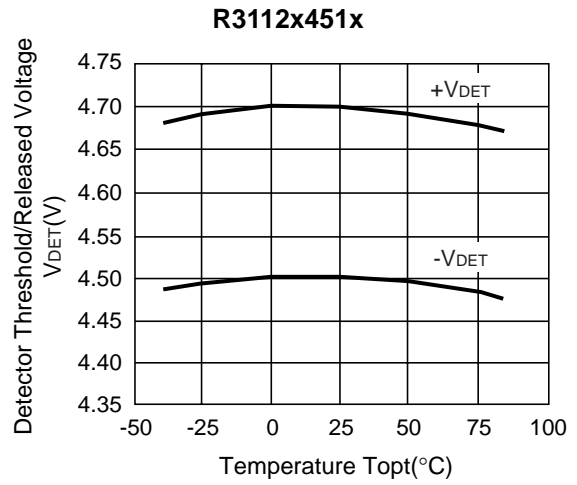
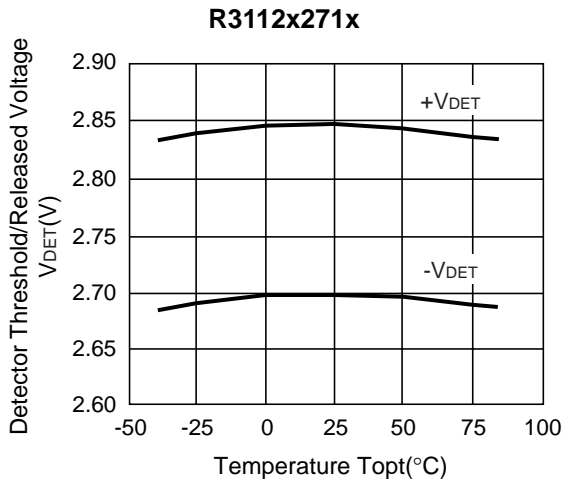

3) Output Voltage vs. Input Voltage

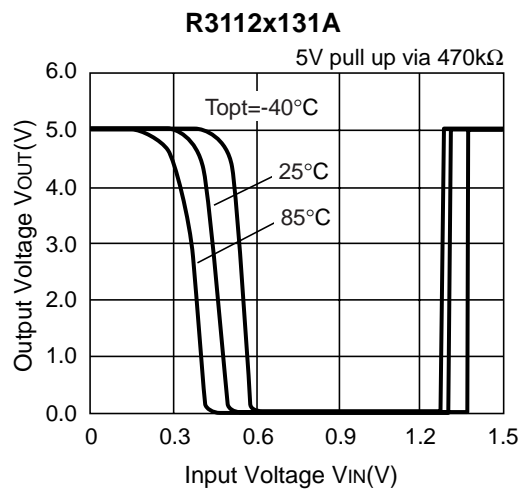
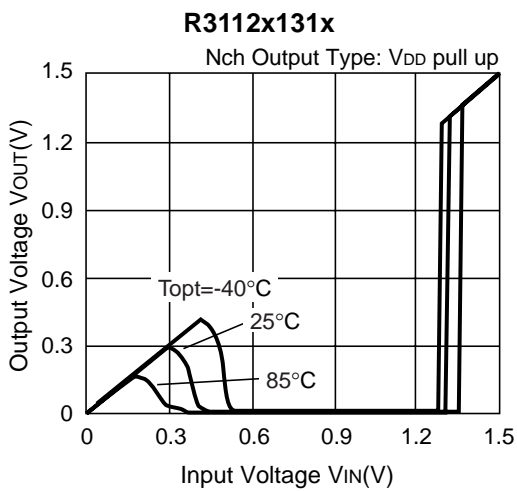
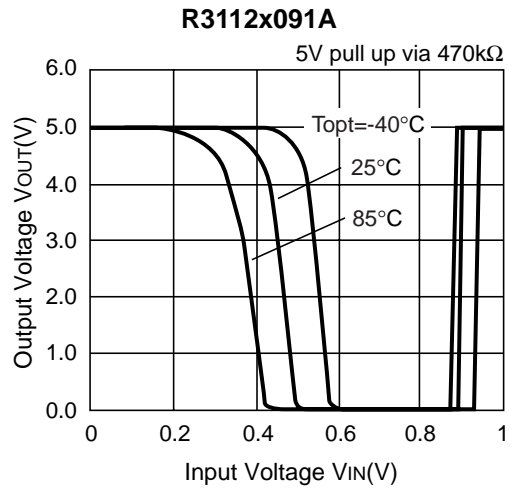
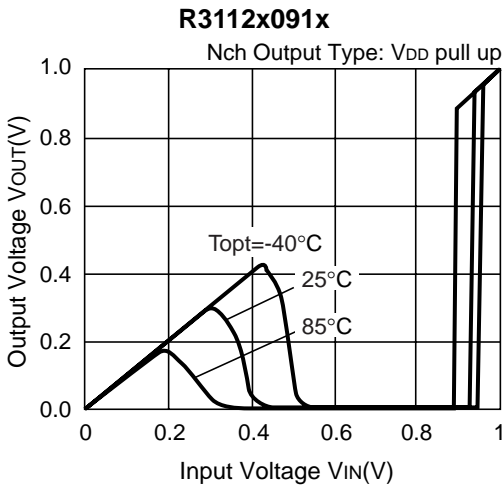

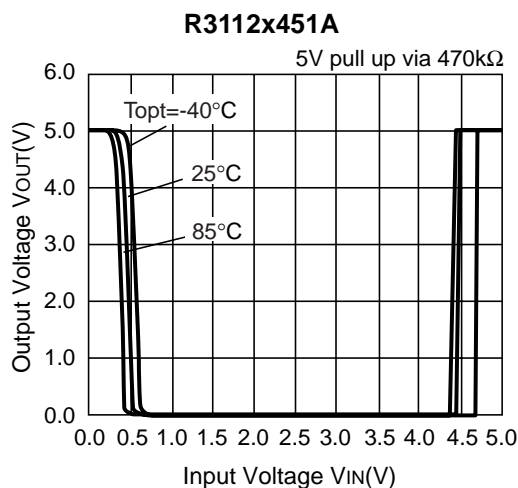
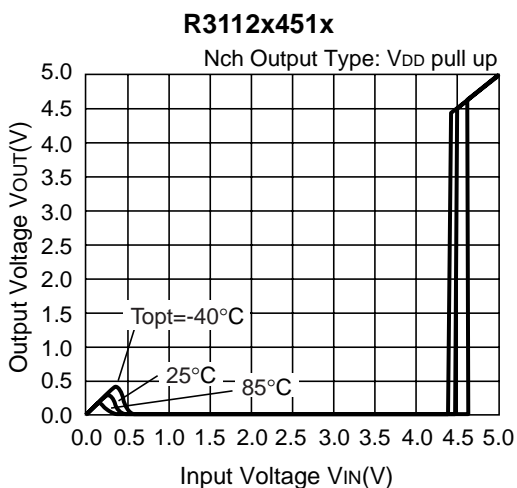
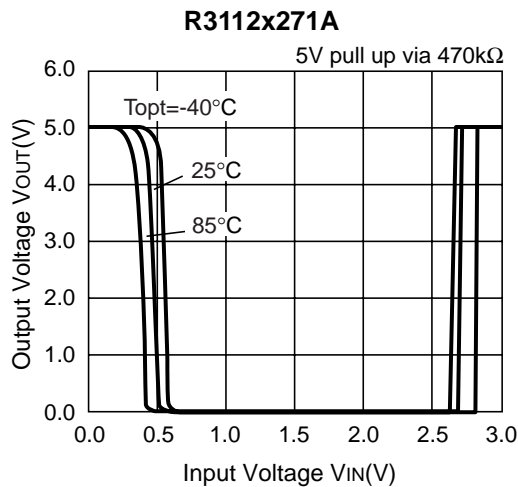
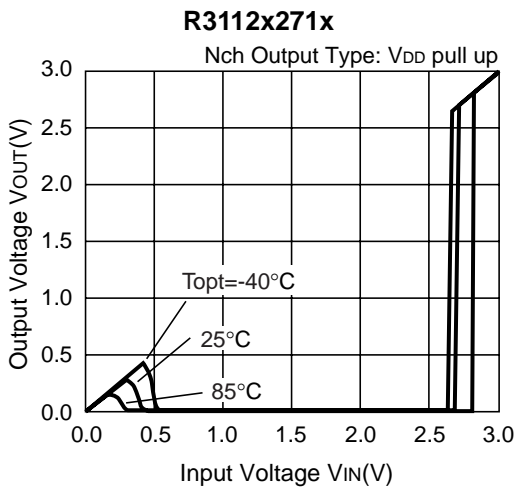

4) Nch Driver Output Current vs. V<sub>DS</sub>

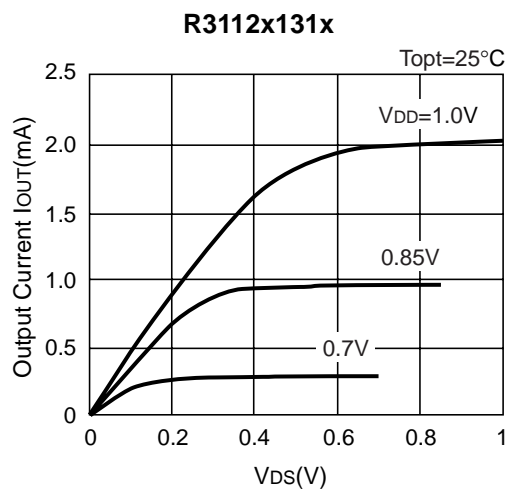
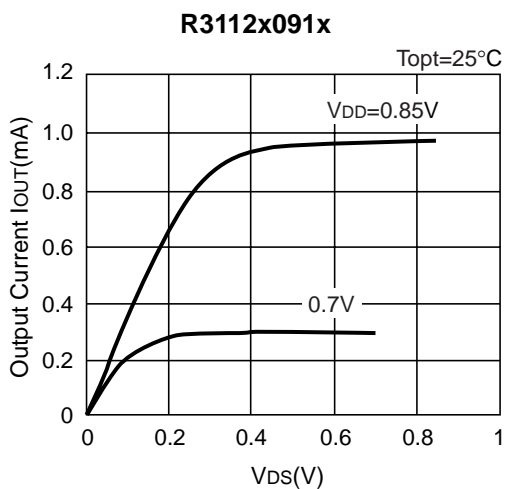

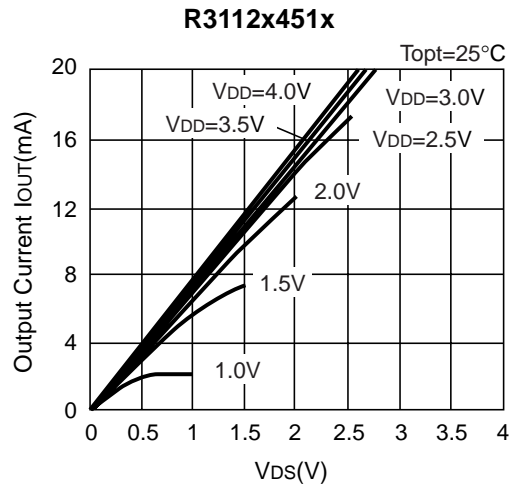
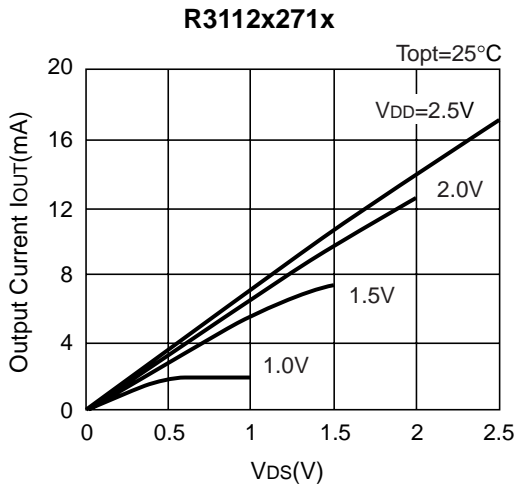

5) Nch Driver Output Current vs. Input Voltage

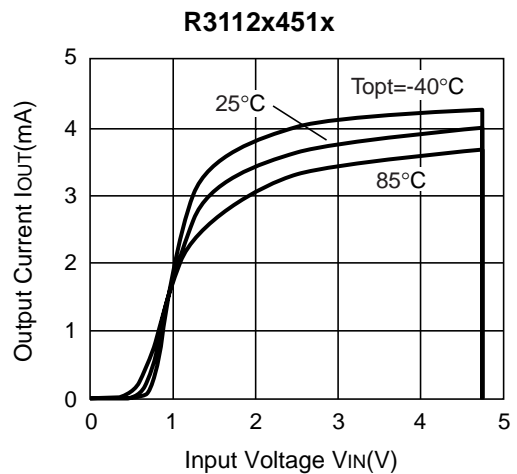
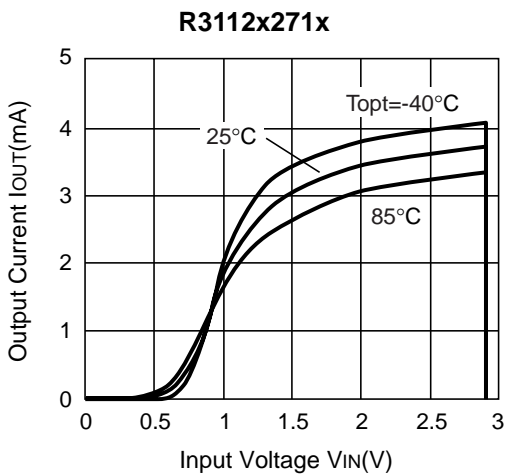
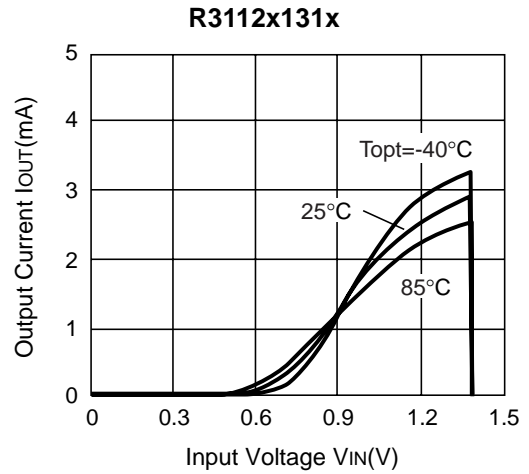
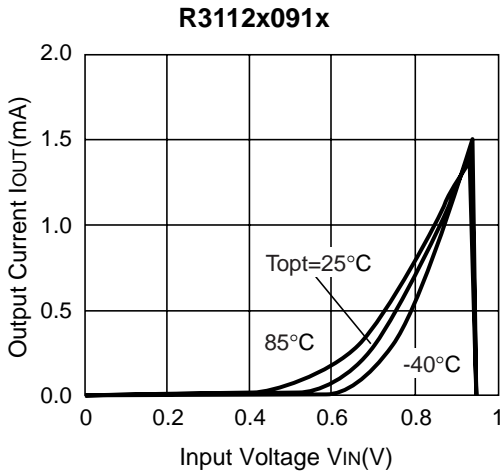



6) Pch Driver Output Current vs. Input Voltage

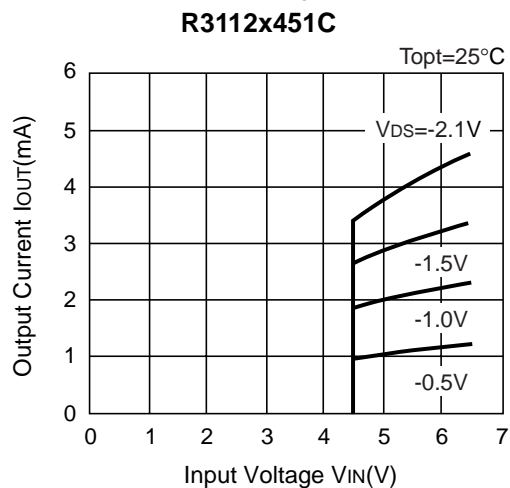
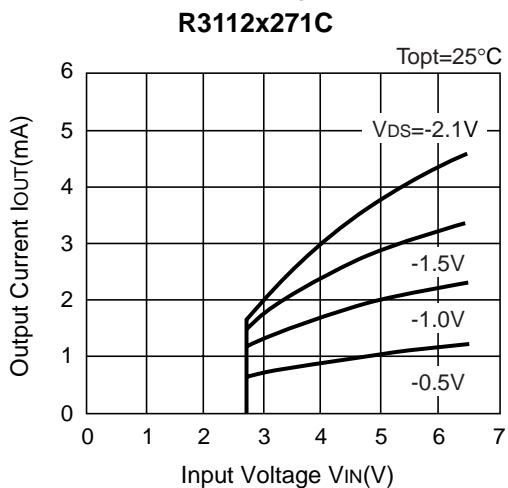
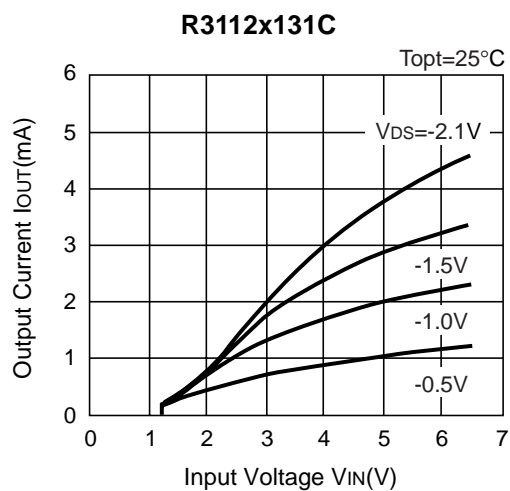
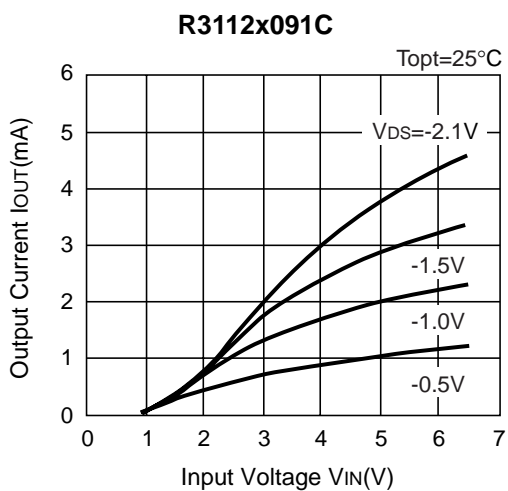

7) CD Pin Threshold Voltage vs. Temperature

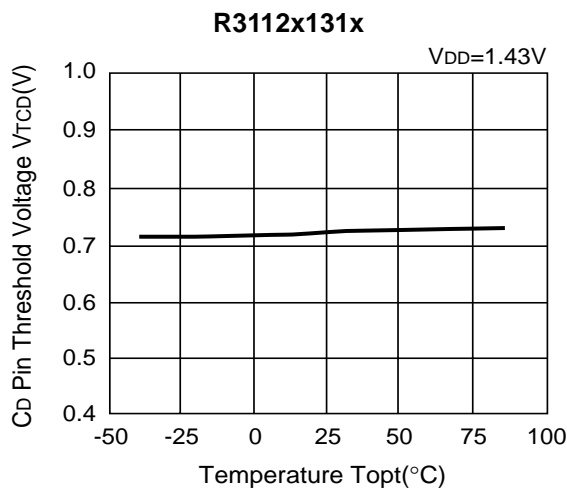
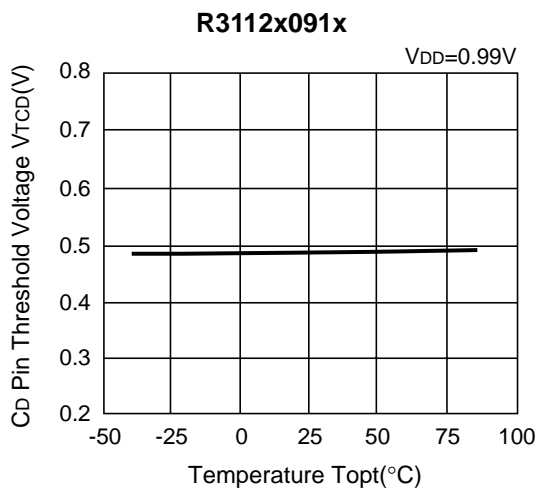

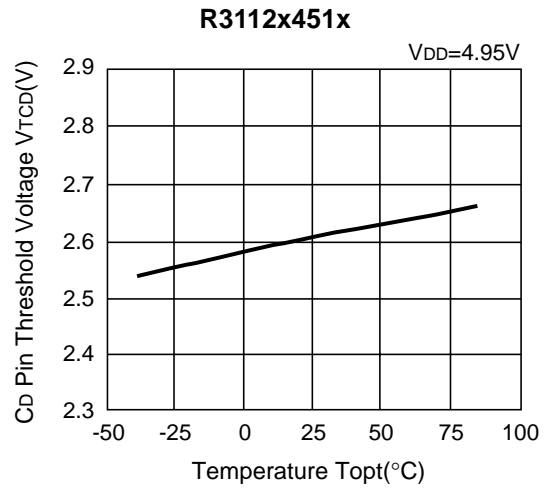
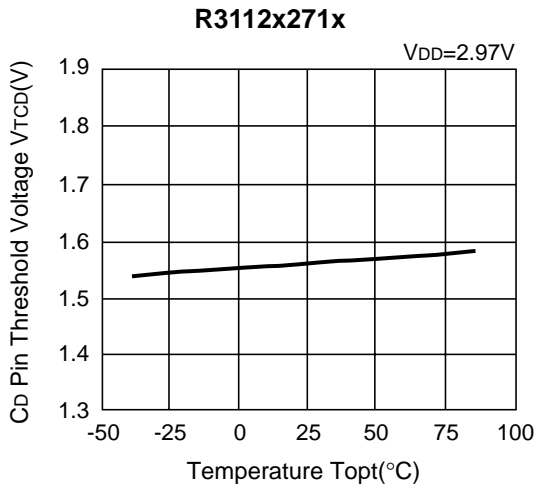

8) CD Pin Output Current vs. Input Voltage

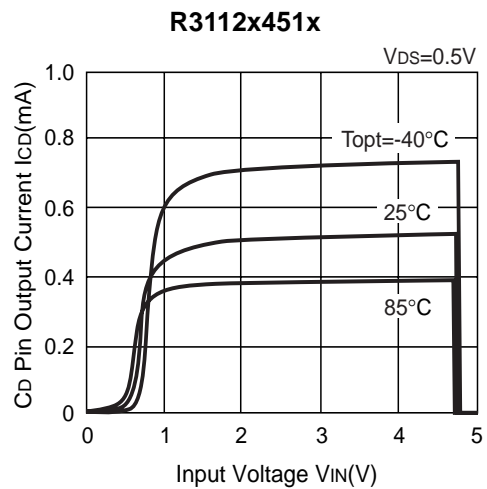
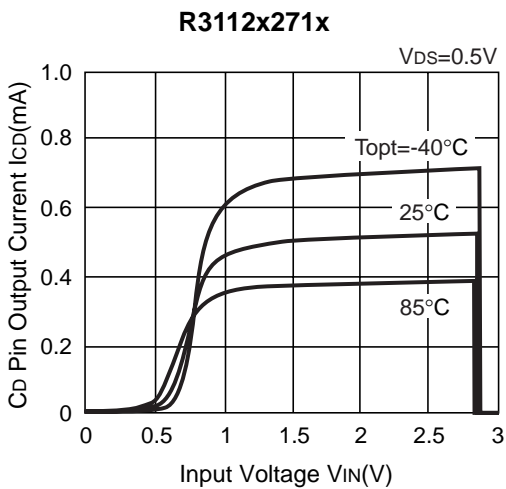
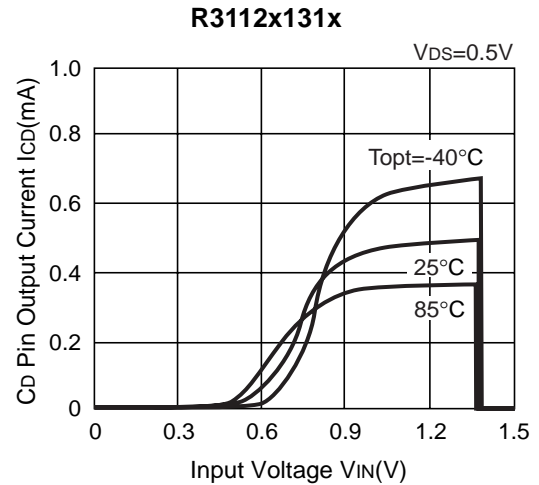
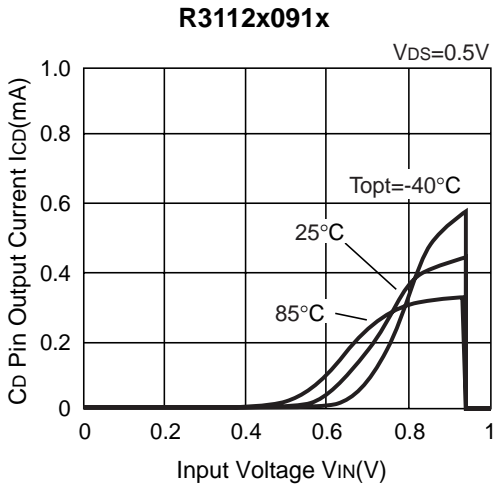

9) CD Pin Output Current vs.  $V_{DS}$  ( $T_{opt}=25^{\circ}C$ )

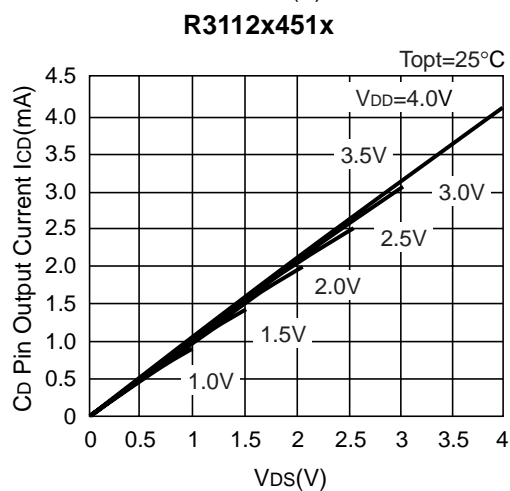
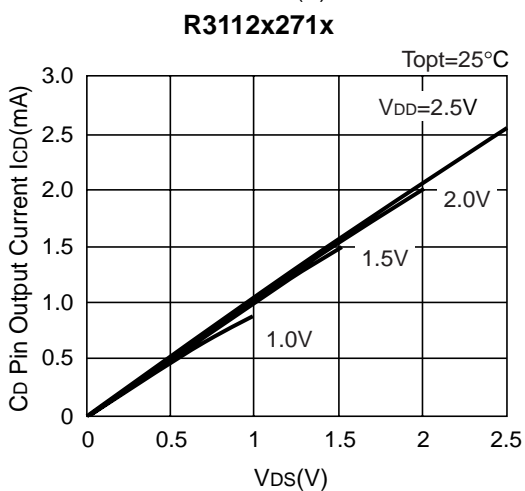
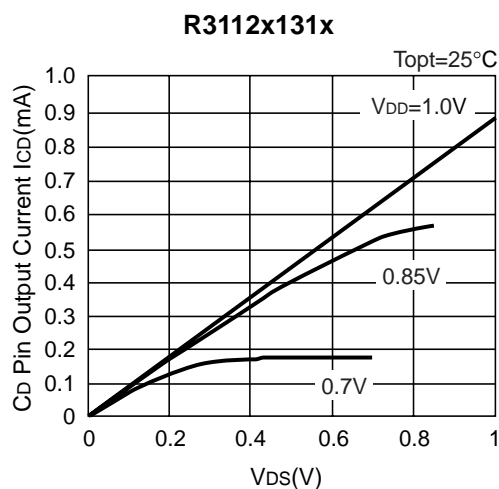
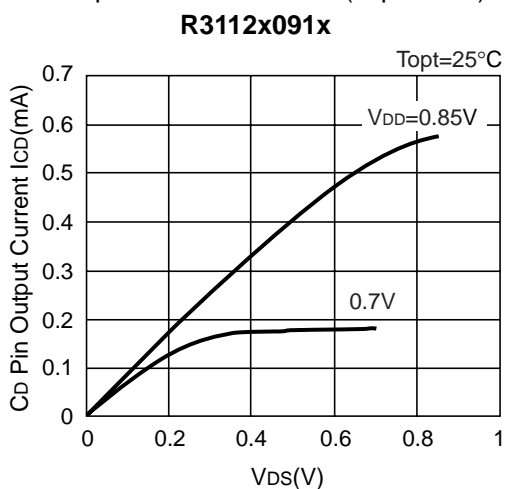

10) Output Delay Time vs. External Capacitance ( $T_{opt}=25^{\circ}C$ )

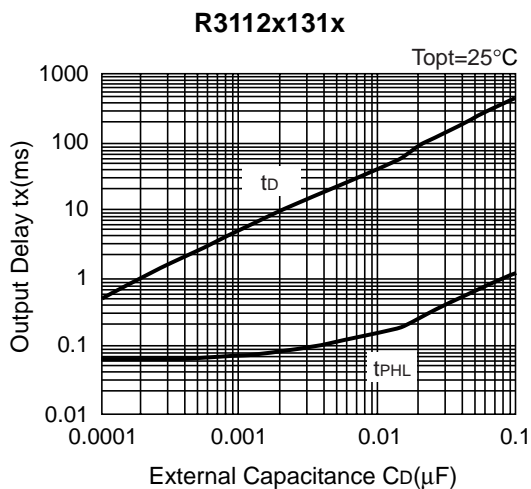
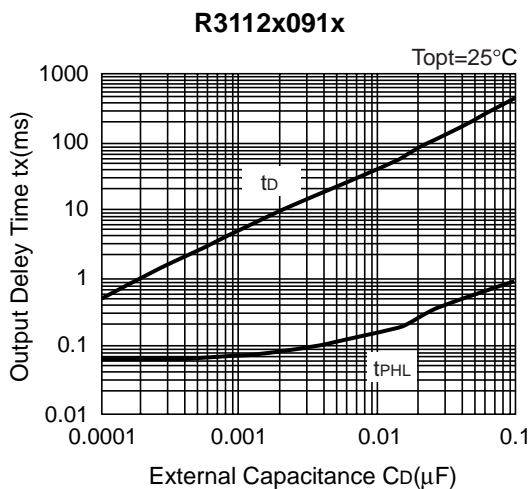

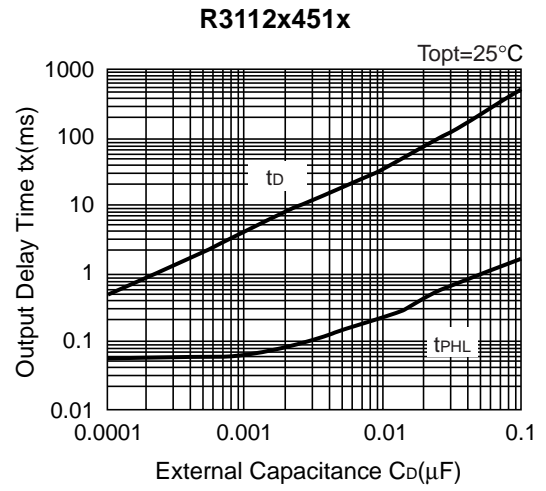
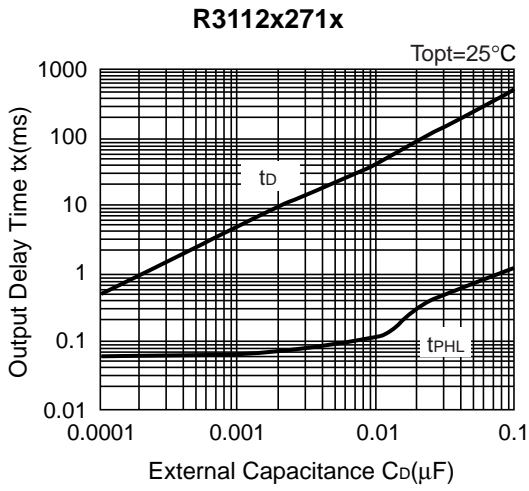

11) Delay Circuit Resistance vs. Temperature

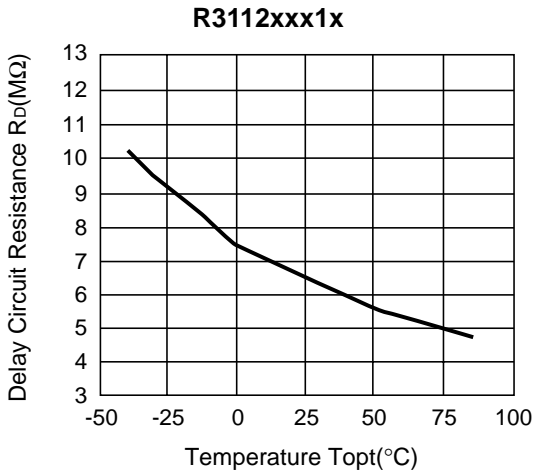

## TECHNICAL NOTES

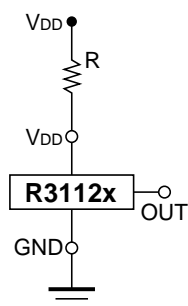

Figure A

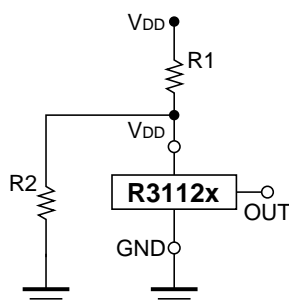

Figure B

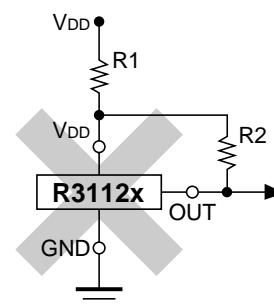

Figure C

When R3112xxx1A (Nch open drain output type) is used in Figure A or Figure B, if impedance of voltage supply pin,  $V_{DD}$  and  $V_{DD}$  of this IC is large, detector threshold level would shift by voltage dropdown caused by the consumption current of the IC itself. Released voltage may also shift and delay time for start-up might be generated by this usage.

When R3112xxx1C (CMOS output type) is used in Figure A or Figure B, Output level could be unstable by cross conduction current which is generated at detector threshold level or at released voltage level, therefore, do not use R3112xxx1C with the connection in Figure A or Figure B.

The connection in Figure C may cause the oscillation in both R3112xxx1C (CMOS Output) and R3112xxx1A (Nch Open Drain Output), therefore do not use R3112xxx1x Series with the connection in Figure C.