

APPROVAL SHEET

MULTILAYER CERAMIC CAPACITORS

Microwave Series (RF)

0201 to 0805 Sizes (6.3V to 250V)

NP0 Dielectric

RoHS Compliance

Datasheet.Live

*Contents in this sheet are subject to change without prior notice.

1. INTRODUCTION

MLCC consists of a conducting material and electrodes. To manufacture a chip-type SMT and achieve miniaturization, high density and high efficiency, ceramic condensers are used.

WTC RF series MLCC is used at high frequencies generally have a small temperature coefficient of capacitance, typical within the $\pm 30\text{ppm}/^\circ\text{C}$ required for NP0 (C0G) classification and have excellent conductivity internal electrode. Thus, WTC RF series MLCC will be with the feature of low ESR and high Q characteristics.

2. FEATURES

- High Q and low ESR performance at high frequency.
- Ultra low capacitance to 0.1pF.
- Can offer high precision tolerance to $\pm 0.05\text{pF}$.
- Quality improvement of telephone calls for low power loss and better performance.

3. APPLICATIONS

- Telecommunication products & equipments: Mobile phone, WLAN, Base station.
- RF module: Power amplifier, VCO.
- Tuners.

4. HOW TO ORDER

RF	15	N	100	J	500	C	I
<u>Series</u>	<u>Size</u>	<u>Dielectric</u>	<u>Capacitance</u>	<u>Tolerance</u>	<u>Rated voltage</u>	<u>Termination</u>	<u>Packaging</u>
RF=Ultra High Q & Low ESR	03=0201 (0603) 15=0402 (1005) 18=0603 (1608) 21=0805 (2012)	N=NP0	Two significant digits followed by no. of zeros. And R is in place of decimal point. eg.: 0R5=0.5pF 1R0=1.0pF 100= 10×10^0 =10pF	A= $\pm 0.05\text{pF}$ B= $\pm 0.1\text{pF}$ C= $\pm 0.25\text{pF}$ D= $\pm 0.5\text{pF}$ F= $\pm 1\%$ G= $\pm 2\%$ J= $\pm 5\%$	Two significant digits followed by no. of zeros. And R is in place of decimal point. 6R3=6.3 VDC 100=10 VDC 250=25 VDC 500=50 VDC 101=100 VDC 251=250 VDC	C=Cu/Ni/Sn	T=7" reeled G= 13" reeled

5. EXTERNAL DIMENSIONS

Size Inch (mm)	L (mm)	W (mm)	T (mm)/Symbol	Remark	M _B (mm)
0201 (0603)	0.60±0.03	0.30±0.03	0.30±0.03	L #	0.15±0.05
0402 (1005)	1.00±0.05	0.50±0.05	0.50±0.05	N #	0.25+0.05/-0.10
0603 (1608)	1.60±0.10	0.80±0.10	0.80±0.07	S	0.40±0.15
0805 (2012)	2.00±0.20	1.25±0.20	0.85±0.10	T	0.50±0.20

Reflow soldering only is recommended.

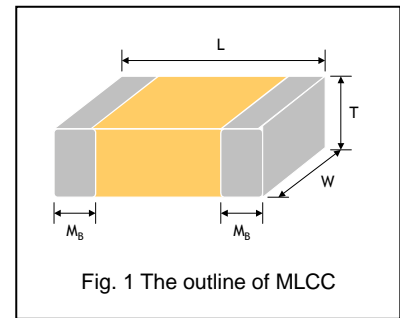

6. GENERAL ELECTRICAL DATA

Dielectric	NP0
Size	0201, 0402, 0603, 0805
Capacitance*	0201: 0.1pF to 33pF; 0402: 0.1pF to 22pF; 0603: 0.3pF to 47pF; 0805: 0.3pF to 100pF
Capacitance tolerance	Cap≤5pF: A (±0.05pF), B (±0.1pF), C (±0.25pF) 5pF<Cap<10pF: B (±0.1pF), C (±0.25pF), D (±0.5pF) Cap≥10pF: F (±1%), G (±2%), J (±5%)
Rated voltage (WVDC)	6.3V, 10V, 25V, 50V, 100V, 250V
Q*	Cap≥30pF, Q≥1000; Cap<30pF, Q≥400+20C
Insulation resistance at U_r	≥10GΩ
Operating temperature	-55 to +125°C
Capacitance change	±30ppm/°C; 0201 Cap ≥22pF, ±60ppm/°C
Termination	Ni/Sn (lead-free termination)

* Measured at the conditions of 25°C ambient temperature and 30~70% relative humidity.

Apply 1.0±0.2Vrms, 1.0MHz±10% for Cap≤1000pF and 1.0±0.2Vrms, 1.0kHz±10% for Cap>1000pF.

7. CAPACITANCE RANGE

DIELECTRIC		NP0					Tolerance
SIZE		0201			0402		
RATED VOLTAGE (VDC)		6.3	10	25	50	100	
Capacitance	0.1pF (0R1)	L	L	L	N	N	B
	0.2pF (0R2)	L	L	L	N	N	A, B
	0.3pF (0R3)	L	L	L	N	N	A, B
	0.4pF (0R4)	L	L	L	N	N	A, B
	0.5pF (0R5)	L	L	L	N	N	A, B, C
	0.6pF (0R6)	L	L	L	N	N	A, B, C
	0.7pF (0R7)	L	L	L	N	N	A, B, C
	0.8pF (0R8)	L	L	L	N	N	A, B, C
	0.9pF (0R9)	L	L	L	N	N	A, B, C
	1.0pF (1R0)	L	L	L	N	N	A, B, C
	1.1pF (1R1)	L	L	L	N	N	A, B, C
	1.2pF (1R2)	L	L	L	N	N	A, B, C
	1.3pF (1R3)	L	L	L	N	N	A, B, C
	1.4pF (1R4)	L	L	L	N	N	A, B, C
	1.5pF (1R5)	L	L	L	N	N	A, B, C
	1.6pF (1R6)	L	L	L	N	N	A, B, C
	1.7pF (1R7)	L	L	L	N	N	A, B, C
	1.8pF (1R8)	L	L	L	N	N	A, B, C
	1.9pF (1R9)	L	L	L	N	N	A, B, C
	2.0pF (2R0)	L	L	L	N	N	A, B, C
	2.1pF (2R1)	L	L	L	N	N	A, B, C
	2.2pF (2R2)	L	L	L	N	N	A, B, C
	2.3pF (2R3)	L	L	L	N	N	A, B, C
	2.4pF (2R4)	L	L	L	N	N	A, B, C
	2.5pF (2R5)	L	L	L	N	N	A, B, C
	2.6pF (2R6)	L	L	L	N	N	A, B, C
	2.7pF (2R7)	L	L	L	N	N	A, B, C
	2.8pF (2R8)	L	L	L	N	N	A, B, C
	2.9pF (2R9)	L	L	L	N	N	A, B, C
	3.0pF (3R0)	L	L	L	N	N	A, B, C
	3.1pF (3R1)	L	L	L	N	N	A, B, C
	3.2pF (3R2)	L	L	L	N	N	A, B, C
	3.3pF (3R3)	L	L	L	N	N	A, B, C
	3.4pF (3R4)	L	L	L	N	N	A, B, C
	3.5pF (3R5)	L	L	L	N	N	A, B, C
	3.6pF (3R6)	L	L	L	N	N	A, B, C
	3.7pF (3R7)	L	L	L	N	N	A, B, C
	3.8pF (3R8)	L	L	L	N	N	A, B, C
	3.9pF (3R9)	L	L	L	N	N	A, B, C
	4.0pF (4R0)	L	L	L	N	N	A, B, C
	4.1pF (4R1)	L	L	L	N	N	A, B, C
	4.2pF (4R2)	L	L	L	N	N	A, B, C
	4.3pF (4R3)	L	L	L	N	N	A, B, C
	4.4pF (4R4)	L	L	L	N	N	A, B, C
	4.5pF (4R5)	L	L	L	N	N	A, B, C
	4.6pF (4R6)	L	L	L	N	N	A, B, C
	4.7pF (4R7)	L	L	L	N	N	A, B, C
	4.8pF (4R8)	L	L	L	N	N	A, B, C
4.9pF (4R9)	L	L	L	N	N	A, B, C	
5.0pF (5R0)	L	L	L	N	N	A, B, C	
5.1pF (5R1)	L	L	L	N	N	B, C, D	
5.2pF (5R2)	L	L	L	N	N	B, C, D	
5.3pF (5R3)	L	L	L	N	N	B, C, D	
5.4pF (5R4)	L	L	L	N	N	B, C, D	
5.5pF (5R5)	L	L	L	N	N	B, C, D	
5.6pF (5R6)	L	L	L	N	N	B, C, D	
5.7pF (5R7)	L	L	L	N	N	B, C, D	
5.8pF (5R8)	L	L	L	N	N	B, C, D	
5.9pF (5R9)	L	L	L	N	N	B, C, D	
6.0pF (6R0)	L	L	L	N	N	B, C, D	

DIELECTRIC		NP0					Tolerance
SIZE		0201			0402		
RATED VOLTAGE (VDC)		6.3	10	25	50	100	
Capacitance	6.1pF (6R1)	L	L	L	N	N	B, C, D
	6.2pF (6R2)	L	L	L	N	N	B, C, D
	6.3pF (6R3)	L	L	L	N	N	B, C, D
	6.4pF (6R4)	L	L	L	N	N	B, C, D
	6.5pF (6R5)	L	L	L	N	N	B, C, D
	6.6pF (6R6)	L	L	L	N	N	B, C, D
	6.7pF (6R7)	L	L	L	N	N	B, C, D
	6.8pF (6R8)	L	L	L	N	N	B, C, D
	6.9pF (6R9)	L	L	L	N	N	B, C, D
	7.0pF (7R0)	L	L	L	N	N	B, C, D
	7.1pF (7R1)	L	L	L	N	N	B, C, D
	7.2pF (7R2)	L	L	L	N	N	B, C, D
	7.3pF (7R3)	L	L	L	N	N	B, C, D
	7.4pF (7R4)	L	L	L	N	N	B, C, D
	7.5pF (7R5)	L	L	L	N	N	B, C, D
	7.6pF (7R6)	L	L	L	N	N	B, C, D
	7.7pF (7R7)	L	L	L	N	N	B, C, D
	7.8pF (7R8)	L	L	L	N	N	B, C, D
	7.9pF (7R9)	L	L	L	N	N	B, C, D
	8.0pF (8R0)	L	L	L	N	N	B, C, D
	8.1pF (8R1)	L	L	L	N	N	B, C, D
	8.2pF (8R2)	L	L	L	N	N	B, C, D
	8.3pF (8R3)	L	L	L	N	N	B, C, D
	8.4pF (8R4)	L	L	L	N	N	B, C, D
	8.5pF (8R5)	L	L	L	N	N	B, C, D
	8.6pF (8R6)	L	L	L	N	N	B, C, D
	8.7pF (8R7)	L	L	L	N	N	B, C, D
	8.8pF (8R8)	L	L	L	N	N	B, C, D
	8.9pF (8R9)	L	L	L	N	N	B, C, D
	9.0pF (9R0)	L	L	L	N	N	B, C, D
	9.1pF (9R1)	L	L	L	N	N	B, C, D
	9.2pF (9R2)	L	L	L	N	N	B, C, D
	9.3pF (9R3)	L	L	L	N	N	B, C, D
	9.4pF (9R4)	L	L	L	N	N	B, C, D
	9.5pF (9R5)	L	L	L	N	N	B, C, D
	9.6pF (9R6)	L	L	L	N	N	B, C, D
	9.7pF (9R7)	L	L	L	N	N	B, C, D
	9.8pF (9R8)	L	L	L	N	N	B, C, D
	9.9pF (9R9)	L	L	L	N	N	B, C, D
	10pF (100)	L	L	L	N	N	F, G, J
11pF (110)	L	L	L	N		F, G, J	
12pF (120)	L	L	L	N		F, G, J	
13pF (130)	L	L	L	N		F, G, J	
15pF (150)	L	L	L	N		F, G, J	
16pF (160)	L	L	L	N		F, G, J	
18pF (180)	L	L	L	N		F, G, J	
20pF (200)	L	L	L	N		F, G, J	
22pF (220)	L	L		N		F, G, J	
24pF (240)	L	L				F, G, J	
27pF (270)	L	L				F, G, J	
30pF (300)	L	L				F, G, J	
33pF (330)	L	L				F, G, J	
36pF (360)						F, G, J	
39pF (390)						F, G, J	
43pF (430)						F, G, J	
47pF (470)						F, G, J	
56pF (560)						F, G, J	
68pF (680)						F, G, J	
82pF (820)						F, G, J	
100pF (101)						F, G, J	

1. The letter in cell is expressed the symbol of product thickness.
2. WTC provide E96 (IEC-63) product range with which capacitance≤10pF.
3. For more information about products with special capacitance or other data, please contact WTC local representative.

DIELECTRIC		NP0						Tolerance
SIZE		0603			0805			
RATED VOLTAGE (VDC)		50	100	250	50	100	250	
Capacitance	0.1pF (0R1)							
	0.2pF (0R2)							
	0.3pF (0R3)	S	S	S	T	T	T	A, B
	0.4pF (0R4)	S	S	S	T	T	T	A, B
	0.5pF (0R5)	S	S	S	T	T	T	A, B, C
	0.6pF (0R6)	S	S	S	T	T	T	A, B, C
	0.7pF (0R7)	S	S	S	T	T	T	A, B, C
	0.8pF (0R8)	S	S	S	T	T	T	A, B, C
	0.9pF (0R9)	S	S	S	T	T	T	A, B, C
	1.0pF (1R0)	S	S	S	T	T	T	A, B, C
	1.2pF (1R2)	S	S	S	T	T	T	A, B, C
	1.5pF (1R5)	S	S	S	T	T	T	A, B, C
	1.8pF (1R8)	S	S	S	T	T	T	A, B, C
	2.2pF (2R2)	S	S	S	T	T	T	A, B, C
	2.7pF (2R7)	S	S	S	T	T	T	A, B, C
	3.3pF (3R3)	S	S	S	T	T	T	A, B, C
	3.9pF (3R9)	S	S	S	T	T	T	A, B, C
	4.7pF (4R7)	S	S	S	T	T	T	A, B, C
	5.6pF (5R6)	S	S	S	T	T	T	B, C, D
	6.8pF (6R8)	S	S	S	T	T	T	B, C, D
	8.2pF (8R2)	S	S	S	T	T	T	B, C, D
	10pF (100)	S	S	S	T	T	T	F, G, J
	11pF (110)	S	S	S	T	T	T	F, G, J
	12pF (120)	S	S	S	T	T	T	F, G, J
	13pF (130)	S	S	S	T	T	T	F, G, J
	15pF (150)	S	S	S	T	T	T	F, G, J
	16pF (160)	S	S	S	T	T	T	F, G, J
	18pF (180)	S	S	S	T	T	T	F, G, J
	20pF (200)	S	S	S	T	T	T	F, G, J
	22pF (220)	S	S	S	T	T	T	F, G, J
24pF (240)	S	S	S	T	T	T	F, G, J	
27pF (270)	S	S	S	T	T	T	F, G, J	
30pF (300)	S	S	S	T	T	T	F, G, J	
33pF (330)	S	S	S	T	T	T	F, G, J	
36pF (360)	S	S	S	T	T	T	F, G, J	
39pF (390)	S	S	S	T	T	T	F, G, J	
43pF (430)	S	S	S	T	T	T	F, G, J	
47pF (470)	S	S	S	T	T	T	F, G, J	
56pF (560)				T	T	T	F, G, J	
68pF (680)				T	T	T	F, G, J	
82pF (820)				T	T	T	F, G, J	
100pF (101)				T	T	T	F, G, J	

1. The letter in cell is expressed the symbol of product thickness.
2. WTC provide E96 (IEC-63) product range with which capacitance≤10pF.
3. For more information about products with special capacitance or other data, please contact WTC local representative.

8. PACKAGING DIMENSION AND QUANTITY

Size	Thickness (mm)/Symbol		Paper tape	
			7" reel	13" reel
0201 (0603)	0.30±0.03	L	15k	70k
0402 (1005)	0.50±0.05	N	10k	50k
0603 (1608)	0.80±0.07	S	4k	15k
0805 (2012)	0.85±0.10	T	4k	15k

Unit: pieces

9. ELECTRICAL CHARACTERISTICS

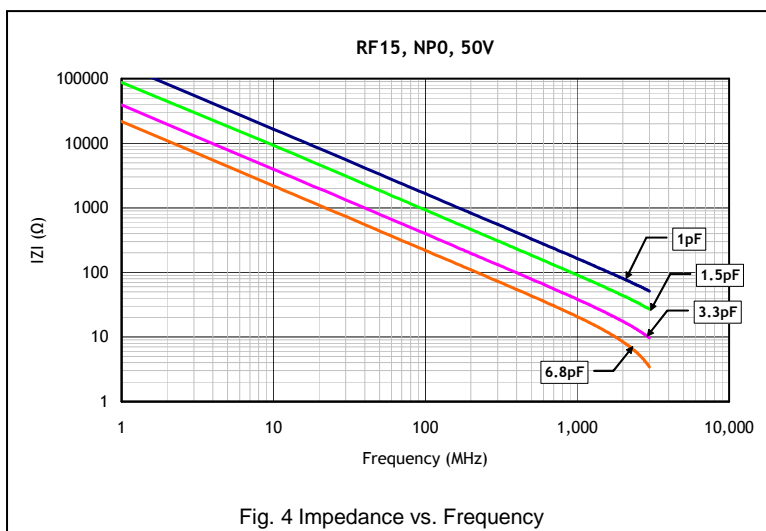
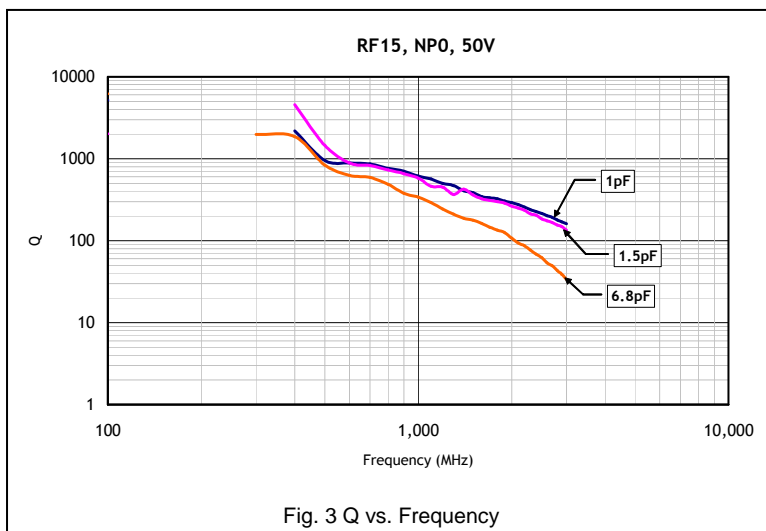
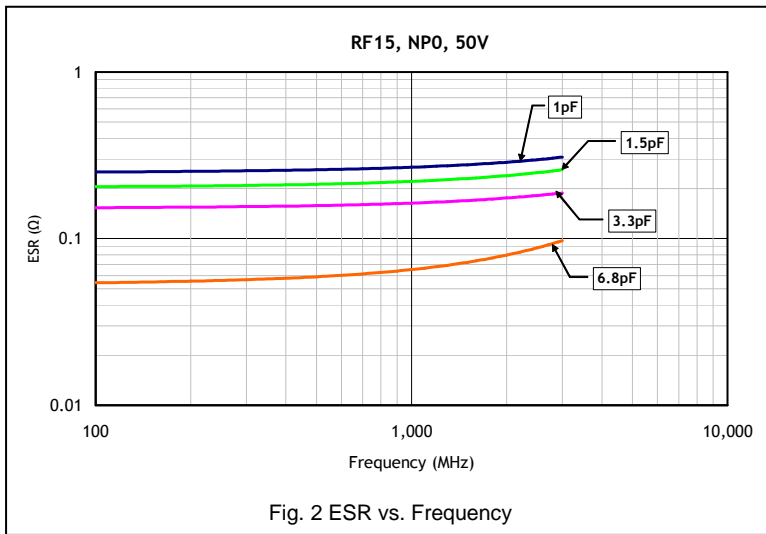

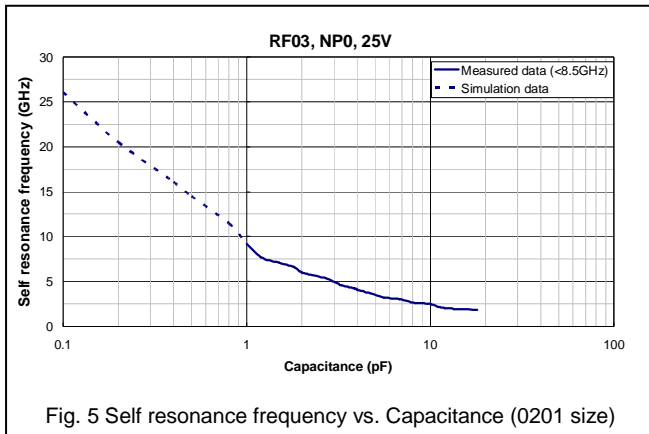

Fig. 5 Self resonance frequency vs. Capacitance (0201 size)

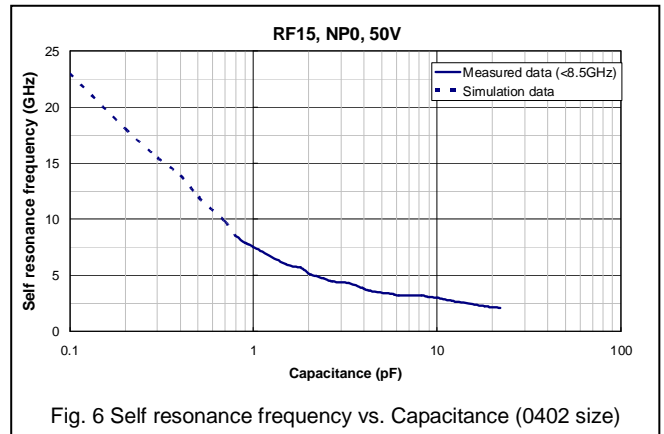

Fig. 6 Self resonance frequency vs. Capacitance (0402 size)

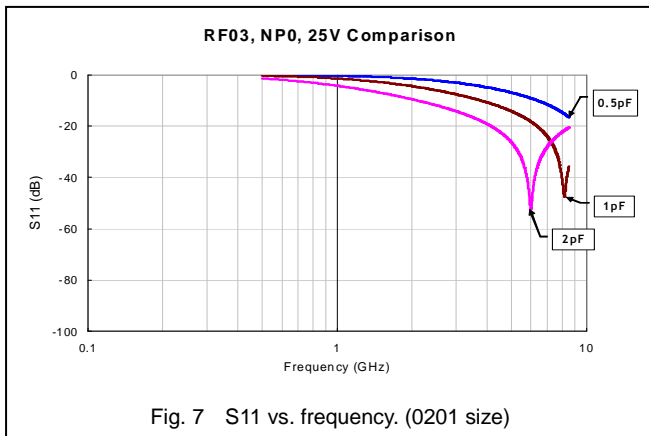

Fig. 7 S11 vs. frequency. (0201 size)

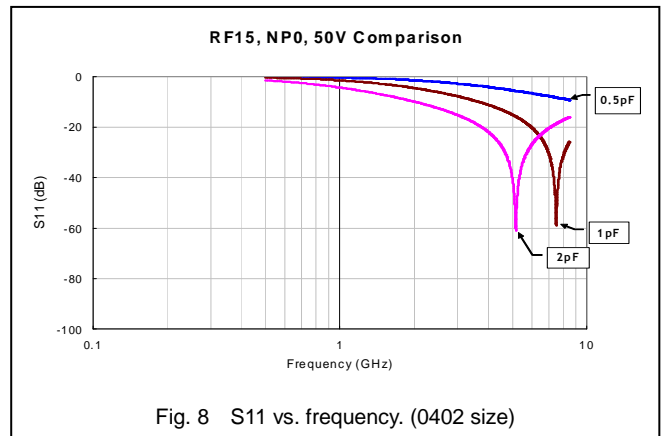

Fig. 8 S11 vs. frequency. (0402 size)

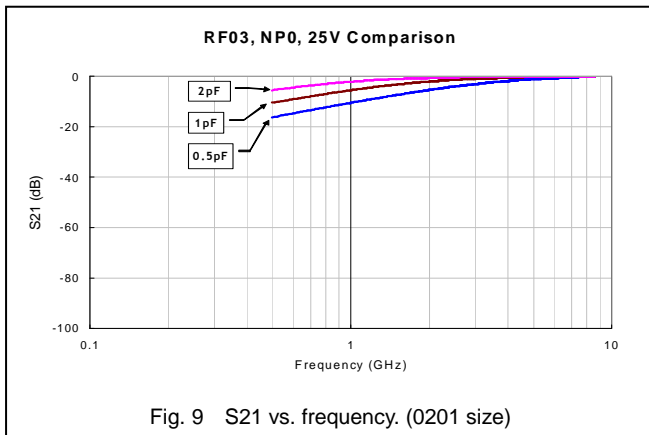

Fig. 9 S21 vs. frequency. (0201 size)

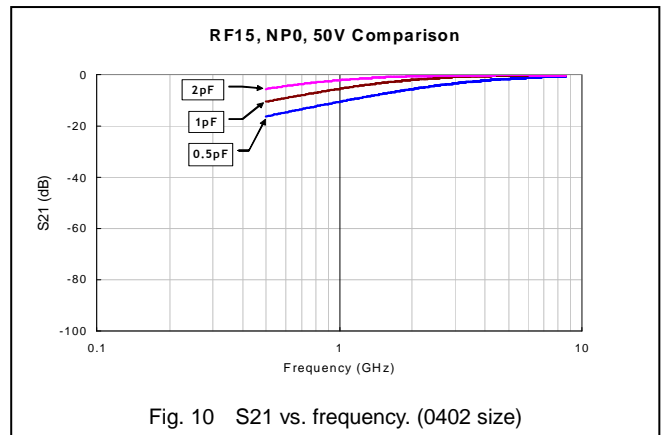

Fig. 10 S21 vs. frequency. (0402 size)

10. RELIABILITY TEST CONDITIONS AND REQUIREMENTS

No.	Item	Test Conditions	Requirements															
1.	Visual and Mechanical		No remarkable defect. Dimensions to conform to individual specification sheet.															
2.	Capacitance	1.0±0.2Vrms, 1MHz±10%	Shall not exceed the limits given in the detailed spec.															
3.	Q/ D.F. (Dissipation Factor)	At 25°C ambient temperature.	Cap≥30pF, Q≥1000; Cap<30pF,Q≥400+20C															
4.	Dielectric Strength	To apply voltage: ≤100V, ≥250% of rated voltage. 250V, ≥200% of rated voltage. Duration: 1 to 5 sec. Charge and discharge current less than 50mA.	No evidence of damage or flash over during test.															
5.	Insulation Resistance	To apply rated voltage for max. 120 sec.	≥10GΩ															
6.	Temperature Coefficient	With no electrical load. Operating temperature: -55~125°C at 25°C	Capacitance change: within ±30ppm/°C; 0201Cap≥22pF, within ±60ppm/°C															
7.	Adhesive Strength of Termination	Pressurizing force : 0201: 2N 0402 & 0603: 5N >0603: 10N Test time: 10±1 sec.	No remarkable damage or removal of the terminations.															
8.	Vibration Resistance	Vibration frequency: 10~55 Hz/min. Total amplitude: 1.5mm Test time: 6 hrs. (Two hrs each in three mutually perpendicular directions.)	No remarkable damage. Cap change and Q/D.F.: To meet initial spec.															
9.	Solderability	Solder temperature: 235±5°C Dipping time: 2±0.5 sec.	95% min. coverage of all metalized area.															
10.	Bending Test	The middle part of substrate shall be pressurized by means of the pressurizing rod at a rate of about 1 mm per second until the deflection becomes 1 mm and then the pressure shall be maintained for 5±1 sec. Measurement to be made after keeping at room temp. for 24±2 hrs.	No remarkable damage. Cap change: within ±5.0% or ±0.5pF whichever is larger. (This capacitance change means the change of capacitance under specified flexure of substrate from the capacitance measured before the test.)															
11.	Resistance to Soldering Heat	Solder temperature: 260±5°C Dipping time: 10±1 sec Preheating: 120 to 150°C for 1 minute before immerse the capacitor in a eutectic solder. Measurement to be made after keeping at room temp. for 24±2 hrs.	No remarkable damage. Cap change: within ±2.5% or ±0.25pF whichever is larger. Q/D.F., I.R. and dielectric strength: To meet initial requirements. 25% max. leaching on each edge.															
12.	Temperature Cycle	Conduct the five cycles according to the temperatures and time. <table border="1" style="margin-left: 20px;"> <thead> <tr> <th>Step</th> <th>Temp. (°C)</th> <th>Time (min.)</th> </tr> </thead> <tbody> <tr> <td>1</td> <td>Min. operating temp. +0/-3</td> <td>30±3</td> </tr> <tr> <td>2</td> <td>Room temp.</td> <td>2~3</td> </tr> <tr> <td>3</td> <td>Max. operating temp. +3/-0</td> <td>30±3</td> </tr> <tr> <td>4</td> <td>Room temp.</td> <td>2~3</td> </tr> </tbody> </table> Measurement to be made after keeping at room temp. for 24±2 hrs.	Step	Temp. (°C)	Time (min.)	1	Min. operating temp. +0/-3	30±3	2	Room temp.	2~3	3	Max. operating temp. +3/-0	30±3	4	Room temp.	2~3	No remarkable damage. Cap change : within ±2.5% or ±0.25pF whichever is larger. Q/D.F., I.R. and dielectric strength: To meet initial requirements.
Step	Temp. (°C)	Time (min.)																
1	Min. operating temp. +0/-3	30±3																
2	Room temp.	2~3																
3	Max. operating temp. +3/-0	30±3																
4	Room temp.	2~3																

No.	Item	Test Condition	Requirements												
13.	Humidity (Damp Heat) Steady State	<ul style="list-style-type: none"> Test temp.: 40±2°C Humidity: 90~95% RH Test time: 500+24/-0hrs. Measurement to be made after keeping at room temp. for 24±2 hrs. 	<ul style="list-style-type: none"> No remarkable damage. Cap change: within ±5.0% or ±0.5pF whichever is larger. Q/D.F. value: Cap≥30pF, Q≥350; 10pF≤Cap<30pF, Q≥275+2.5C Cap<10pF; Q≥200+10C I.R.: ≥1GΩ. 												
14.	Humidity (Damp Heat) Load	<ul style="list-style-type: none"> Test temp.: 40±2°C Humidity: 90~95%RH Test time: 500+24/-0 hrs. To apply voltage : rated voltage Measurement to be made after keeping at room temp. for 24±2 hrs. 	<ul style="list-style-type: none"> No remarkable damage. Cap change: within ±7.5% or ±0.75pF whichever is larger. Q/D.F. value: Cap≥30pF, Q≥200; Cap<30pF, Q≥100+10/3C I.R.: ≥500MΩ. 												
15.	High Temperature Load (Endurance)	<ul style="list-style-type: none"> Test temp.: 125±3°C To apply voltage: 200% of rated voltage. Test time: 1000+24/-0 hrs. Measurement to be made after keeping at room temp. for 24±2 hrs. 	<ul style="list-style-type: none"> No remarkable damage. Cap change: within ±3.0% or ±0.3pF whichever is larger. Q/D.F. value: Cap≥30pF, Q≥350 10pF≤Cap<30pF, Q≥275+2.5C Cap<10pF, Q≥200+10C I.R.: ≥1GΩ. 												
16.	ESR	The ESR should be measured at room temperature and tested at frequency 1±0.1 GHz.	<table border="1"> <thead> <tr> <th>0201, 0402</th> <th>0603</th> <th>0805</th> </tr> </thead> <tbody> <tr> <td>0.5pF≤Cap≤1pF:< 350mΩ</td> <td>0.3pF≤Cap≤1pF:< 1500mΩ</td> <td>0.3pF≤Cap≤1pF: < 1500mΩ</td> </tr> <tr> <td>1pF<Cap≤5pF:< 300mΩ</td> <td>1pF<Cap≤10pF:< 250mΩ</td> <td>1pF<Cap≤10pF: < 250mΩ</td> </tr> <tr> <td>5pF<Cap≤22pF:< 250mΩ</td> <td>10pF<Cap≤47pF:< 200mΩ</td> <td>Cap>10pF: < 200mΩ</td> </tr> </tbody> </table>	0201, 0402	0603	0805	0.5pF≤Cap≤1pF:< 350mΩ	0.3pF≤Cap≤1pF:< 1500mΩ	0.3pF≤Cap≤1pF: < 1500mΩ	1pF<Cap≤5pF:< 300mΩ	1pF<Cap≤10pF:< 250mΩ	1pF<Cap≤10pF: < 250mΩ	5pF<Cap≤22pF:< 250mΩ	10pF<Cap≤47pF:< 200mΩ	Cap>10pF: < 200mΩ
		0201, 0402	0603	0805											
0.5pF≤Cap≤1pF:< 350mΩ	0.3pF≤Cap≤1pF:< 1500mΩ	0.3pF≤Cap≤1pF: < 1500mΩ													
1pF<Cap≤5pF:< 300mΩ	1pF<Cap≤10pF:< 250mΩ	1pF<Cap≤10pF: < 250mΩ													
5pF<Cap≤22pF:< 250mΩ	10pF<Cap≤47pF:< 200mΩ	Cap>10pF: < 200mΩ													
The ESR should be measured at room temperature and tested at frequency 500±50 MHz.	0201, 22pF≤Cap≤33pF: < 300mΩ														

APPENDIXES

▣ Tape & reel dimensions

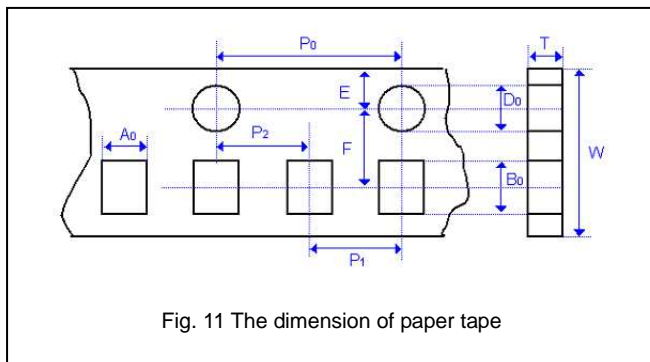

Fig. 11 The dimension of paper tape

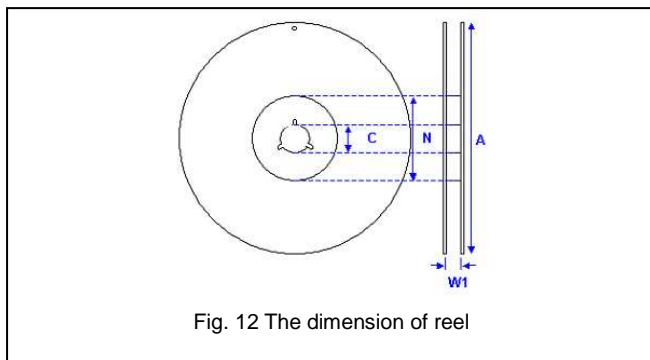
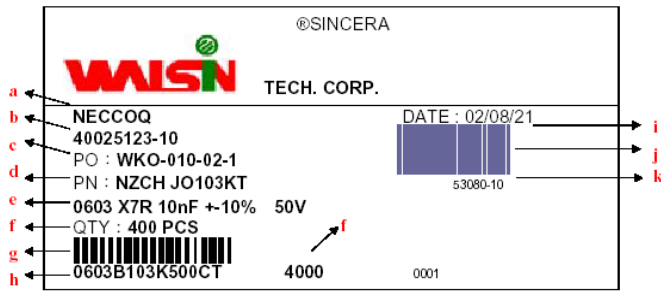

Fig. 12 The dimension of reel

Size	0201	0402	0603	0805
Thickness	L	N	S	T
A₀	0.37±0.03	0.62±0.05	1.00 +0.05/-0.1	1.50±0.10
B₀	0.67±0.03	1.12±0.05	1.80±0.10	2.30±0.10
T	0.42±0.03	0.60±0.05	0.95±0.05	0.95±0.05
K₀	-	-	-	-
W	8.00±0.10	8.00±0.10	8.00±0.10	8.00±0.10
P₀	4.00±0.10	4.00±0.10	4.00±0.10	4.00±0.10
10xP₀	40.0±0.10	40.0±0.10	40.0±0.20	40.0±0.20
P₁	2.00±0.05	2.00±0.05	4.00±0.10	4.00±0.10
P₂	2.00±0.05	2.00±0.05	2.00±0.05	2.00±0.05
D₀	1.55±0.05	1.55±0.05	1.55±0.05	1.55±0.05
D₁	-	-	-	-
E	1.75±0.05	1.75±0.05	1.75±0.05	1.75±0.05
F	3.50±0.05	3.50±0.05	3.50±0.05	3.50±0.05

Size	0201, 0402, 0603, 0805	
Reel size	7"	13"
C	13.0+0.5/-0.2	13.0+0.5/-0.2
W₁	8.4+1.5/-0	8.4+1.5/-0
A	178.0±1.0	330.0±1.0
N	60.0+1.0/-0	100±1.0

▣ Description of customer label



- a. Customer name
- b. WTC order series and item number
- c. Customer P/O
- d. Customer P/N
- e. Description of product
- f. Quantity
- g. Bar code including quantity & WTC P/N or customer
- h. WTC P/N
- i. Shipping date
- j. Order bar code including series and item numbers
- k. Serial number of label

▣ Constructions

No.	Name	NPO
①	Ceramic material	BaTiO ₃ based
②	Inner electrode	Cu
③	Termination	Inner layer
④		Middle layer
⑤		Outer layer
		Sn (Matt)

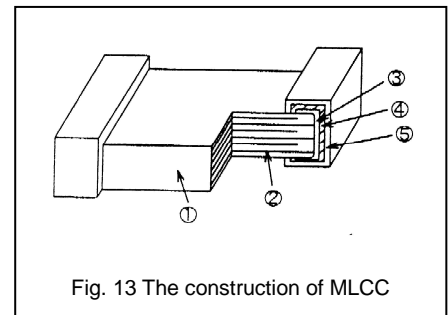

Fig. 13 The construction of MLCC

▣ Storage and handling conditions

- (1) To store products at 5 to 40°C ambient temperature and 20 to 70% related humidity conditions.
- (2) The product is recommended to be used within one year after shipment. Check solderability in case of shelf life extension is needed.

Cautions:

- a. The corrosive gas reacts on the terminal electrodes of capacitors, and results in the poor solderability. Do not store the capacitors in the ambience of corrosive gas (e.g., hydrogen sulfide, sulfur dioxide, chlorine, ammonia gas etc.)
- b. In corrosive atmosphere, solderability might be degraded, and silver migration might occur to cause low reliability.
- c. Due to the dewing by rapid humidity change, or the photochemical change of the terminal electrode by direct sunlight, the solderability and electrical performance may deteriorate. Do not store capacitors under direct sunlight or dewing condition. To store products on the shelf and avoid exposure to moisture.

▣ Recommended soldering conditions

The lead-free termination MLCCs are not only to be used on SMT against lead-free solder paste, but also suitable against lead-containing solder paste. If the optimized solder joint is requested, increasing soldering time, temperature and concentration of N₂ within oven are recommended.

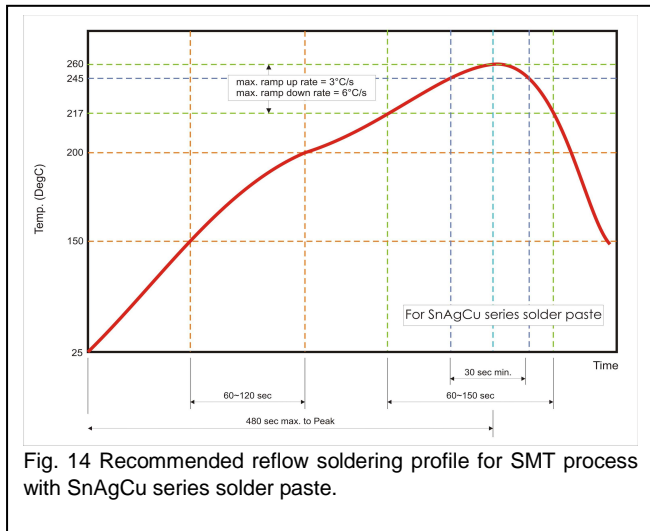

Fig. 14 Recommended reflow soldering profile for SMT process with SnAgCu series solder paste.

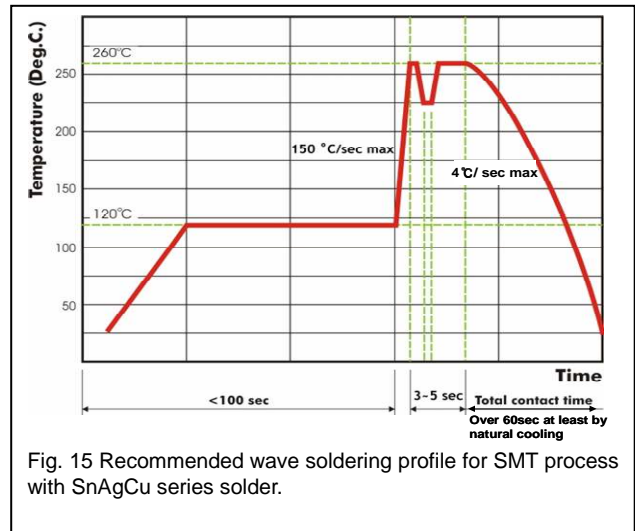

Fig. 15 Recommended wave soldering profile for SMT process with SnAgCu series solder.