

Think GAIA
For Life and the Earth

SANYO

**Solid Electrolytic Capacitors
with Polymerized Organic Semiconductor**

2007-10

POSCAPTM
CAPACITORS

Datasheet

www.edc.sanyo.com

PRECAUTIONS

- This catalog was produced in October 2007. Product names and specifications are subject to change and products themselves are subject to discontinuation without prior notice. Be sure to check the specifications before using your product.
- Products described herein are not intended for applications requiring extremely high reliability (for example, those in which extensive human injury or property damage may occur such as with life-support systems or aircraft control systems). For such applications, consult our sales department.
- This document defines performance, characteristics and functions of each product under pre-determined conditions. It does not guarantee performance, characteristics and functions when used in customer systems. Be sure to check your system before using the product for possible problems or occurrences that cannot be detected during the evaluation testing of each product.
- Electronic Device Company has full confidence in the quality and reliability of its products. However, misuse can result in personal injury, fire or other property damage. For questions regarding usage, please contact our sales department.
- Should you wish to export any product that is listed as regulated goods (including services) under the Foreign Exchange and Foreign Trade Law, an export license is required before exporting.
- This document may not be reprinted or reproduced in part or whole without the permission of Electronic Device Company.
- Electronic Device Company shall not be held responsible for any problems affecting a third party's industrial property arising from use of these products unless such problems are caused by structural or manufacturing flaws.

Series integration

Please make note that all models from TPA, APA, APB series as well as the 16V TPB-TPC series, some models of the TPD series are being integrated into the following series.

Discontinued series	Integrated series
TPA	TPB
APA	APC
APB	APD
TPB(16TPB47M,16TPB47ML)	TQC(16TQC47M)
TPC(16TPC33M)	TQC(16TQC33M)
10TPD150M	10TPF150ML
6TPD330M	6TPF330ML
6TPD220M	6TPF220ML
4TPD470M	4TPF470ML
4TPD330M	4TPF330ML
2R5TPD680M	2R5TPF680ML
2R5TPD680M8	2R5TPF680M8L
2R5TPD470M	2R5TPF470ML
2R5TPD470M8	2R5TPF470M8L

INDEX SANYO POSCAP CAPACITORS

▶ Product guide		
▼ Product Line-up Table		2
▼ Out Line		3
▼ Series System Diagram		4
▼ Products List		6
▼ Guidelines and Precautions for Use		8
▼ Environmental Consideration		11
▼ Marking		12
▼ Explanation of Part Numbers		13
▼ Structure		14
▼ Taping Specifications		15
▼ Recommended Land Pattern Dimension		16
▼ Recommended Soldering Condition		17
▼ Characteristics		18
▶ Specifications of POSCAP in Series	TPB Series	20
	TPB Series B2 size	22
	TPC Series	24
	TPC Series B1 size	26
	TPD Series	27
	TPE Series D2E,D3L,D4 size	28
	TPE Series C3,C2,B2 size	30
	TPF Series	32
	TPG Series	33
	TPL/TPLF Series	34
	TPU Series	36
	TA Series	37
	TH Series	38
	TR Series	40
	TQC Series	42
	APC/APD Series	43
▶ Adoption Example		44

- POSCAP is uniquely structured solid electrolytic capacitor.
- Please note the operating precautions in order to take full advantage of the POSCAP's performance and ensure the most stable quality possible.

Series	Characteristics	Low Profile	Small size	Low ESR	High Capacitance	Low ESL	High Reliability	High Voltage	Category temperature range (°C)	Rated Voltage range (V.DC)	Capacitance range (µF)	Page
T P B	Standard Products								-55 to +105	2.5 to 10	33 to 1000	20
T P C	Low Profile Products	●							-55 to +105	2.5 to 12.5	10 to 330	24
T P D	Low ESR · High Capacitance Products			●	●				-55 to +105	2.5 to 6.3	470 to 1000	27
T P E	Low ESR Products			●					-55 to +105	2 to 10	47 to 1500	28
T P F	Low ESR · High Capacitance Products			●	●				-55 to +105	2 to 10	150 to 680	32
T P G	Small Size · High Capacitance Products		●		●				-55 to +105	2.5 to 12.5	33 to 220	33
T P L	Low ESR · Low ESL Products Face Down Terminal Type			●		●			-55 to +105	2.5	220 to 470	34
T P L F	Low ESR · Low ESL Products Face Down Terminal Type			●		●			-55 to +105	2	220 to 470	34
T P U	Small Size · Low Profile Products Face Down Terminal Type	●	●						-55 to +85	2.5 to 10	10 to 100	36
T A	High Reliability Products (For The Car Electronics)						●		-55 to +105	2.5 to 10	47 to 680	37
T H	125°C Guaranteed Products						●		-55 to +125	2.5 to 10	68 to 1000	38
T R	High Moisture Resistance Products						●		-55 to +105	2.5 to 10	33 to 680	40
T Q C	High Voltage Products							●	-55 to +105	16 to 25	5.6 to 68	42
A P C	Aluminum Anode Products								-55 to +105	4 to 6.3	10 to 33	43
A P D	Aluminum Anode · Low Profile Products	●							-55 to +105	4 to 6.3	10 to 15	43

"POSCAP" is a solid electrolytic chip capacitor. The Anode is sintered Tantalum and the Cathode is a highly conductive polymer formed on SANYO Original method.

"POSCAP" has a Lowest E.S.R. (Equivalent Series Resistance) level and excellent performance for high frequency though low profile and high capacitance.

In addition, it has high reliability and high heat resistance.

Therefore, "POSCAP" is an ideal chip capacitor especially for digital, high frequency devices.

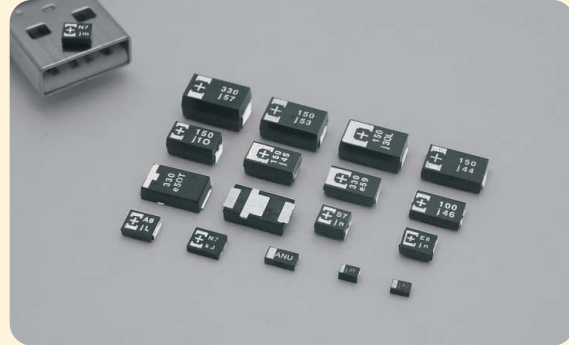

■ Features

● Lead free

Terminal plating is Palladium and Gold. It's completely lead free.

● Low profile chip capacitor

● Low impedance and low ESR at high frequency

● High ripple current capability

● Long Life 105°C×2,000Hrs*

● Excellent noise-absorbent characteristics

● Excellent temperature characteristics up to -55°C

● The rush current is guaranteed for 20A

● Superior to Ta-Cap in safety

★A part of the model is excluded.

■ Applications

● DC/DC Converter

● Personal Computers

● VCR, Camcorder, Digital Still Camera

● Portable Communications Devices and Base Station

● PDA (Portable terminals, etc.)

● Navigation System

● HD Drive, MO Drive, DVD Drive

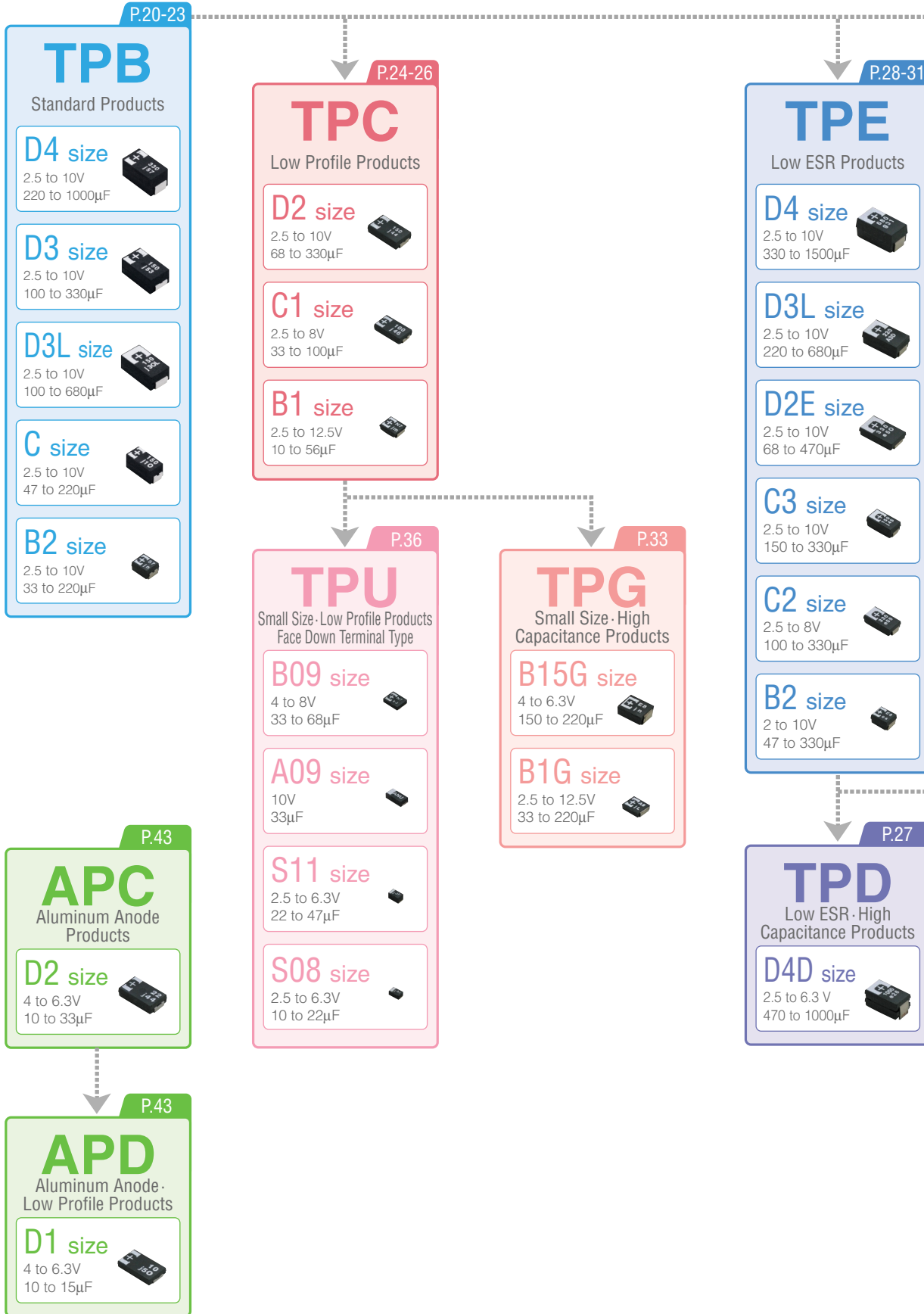

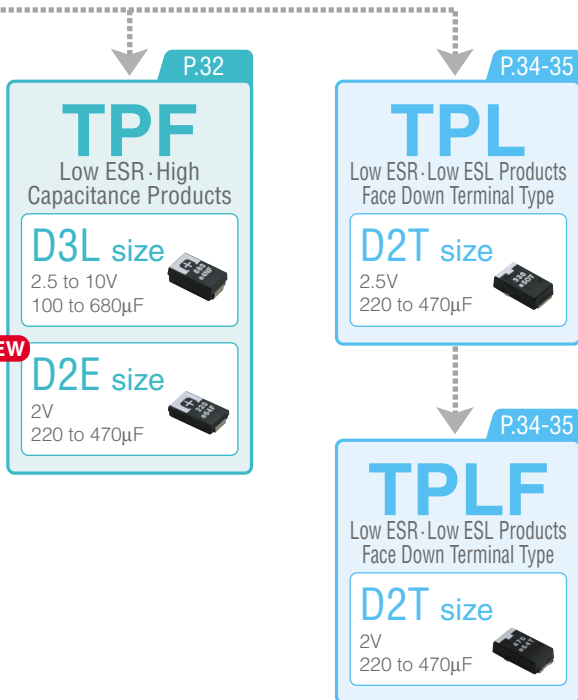
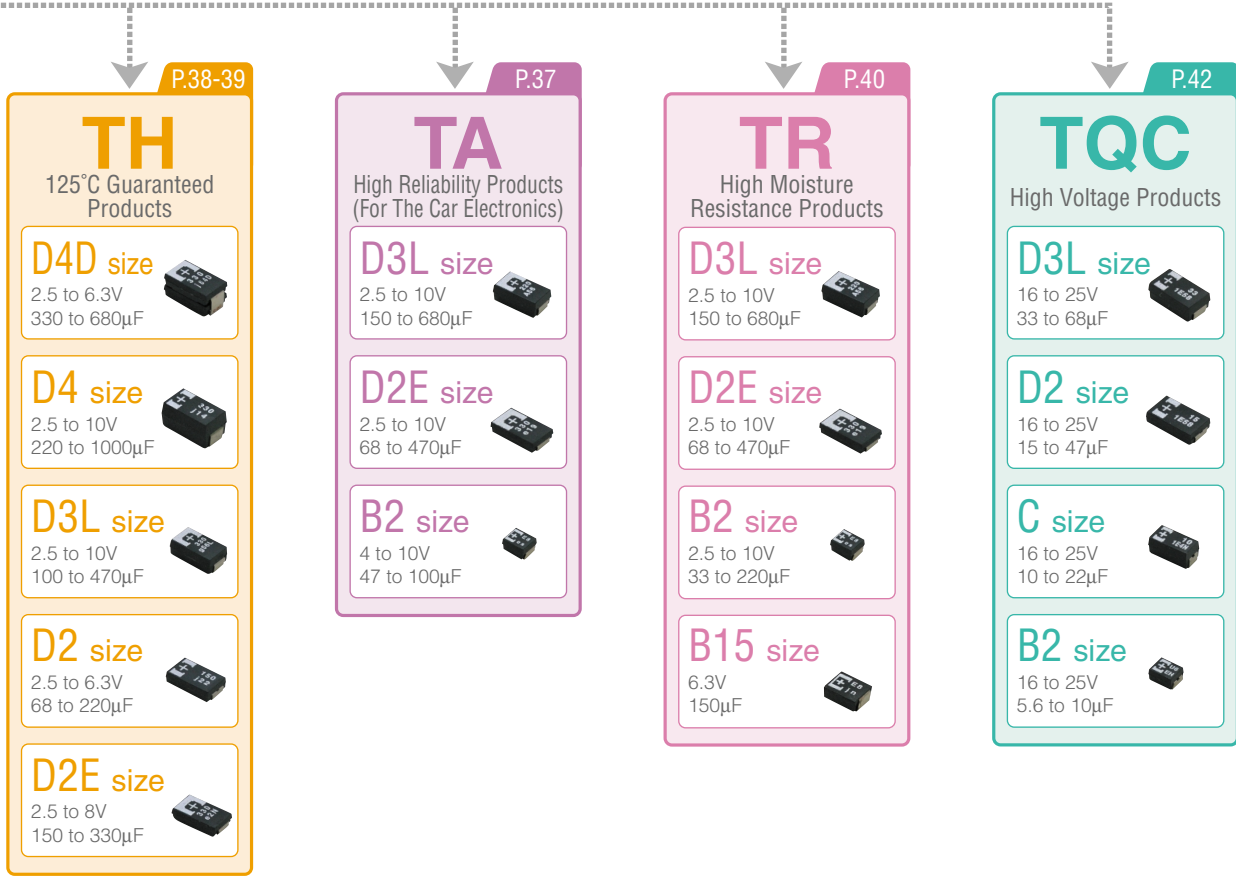

The size of each photo is close to full scale.

*Under development *1(F:15, I:18, M:25) *2(C:12, F:15, I:18, M:25) *3(9, C:12, F:15, I:18, M:25)
 *4(5, 6, 8, 10)

•Symbols in table:Case Size
 •():ESR specification(mΩmax.)

WV	Series	μF	2.2	4.7	5.6	6.8	8.2	10	15	22	33	47	56	
2V	TPE													
	TPE													
	TPF													
	TPLF													
2.5V	TPB													
	TPB													
	TPC												B1(70)	
	TPD													
	TPE													
	TPE													
	TPE													
	TPF													
	TPG													
	TPL													
TPU										S08(250)		S11(150)		
3.15V	TPU													
4V	TPB													
	TPB													
	TPB													
	TPC												C1(70)	
	TPC											B1(70)		
	TPD													
	TPE													
	TPE													
	TPE													
	TPF													
	TPG													
	TPU								S08(250)			S11(150)		
	TPU											D2(40)		
	APD								D1(70)					
6.3V	TPB											B2(70)		
	TPB													
	TPB													
	TPC										B1(70)	B1(70)		
	TPC													
	TPD													
	TPE													
	TPE													
	TPE													
	TPF													
	TPG													
	TPU							S08(250)			S11(150)		B09(70)	
	TPU												A09(150)	
	APC							D2(70)			D2(40)			
APD							D1(70)							
8V	TPB										B2(70)	B2(70)		
	TPC									B1(70)	C1(70)			
	TPE													
	TPG											B1G(70)		
	TPU											B09(70)		
10V	TPB										B2(70)	C(55)		
	TPB											B2(70)		
	TPC										B1(70)			
	TPE											B2(35)		
	TPF													
	TPG											B1G(70)	B1G(70)	
TPU											A09(150)			
12.5V	TPC							B1(80)	B1(80)					
	TPG											B1G(70)		
16V	TQC							B2(100)		C(80)	D2(70)	D2(70)		
	TQC											D3L(45)		
20V	TQC						B2(100)		C(80)	D2(80)	D2(45)	D3L(55)		
25V	TQC			B2(100)				C(95)	D2(90,45)	D2(90,45)	D3L(60)			

Case size

(unit:mm)

	S08	S11	A09	B09	B1	B1G	B15G	B2	C1	C2	C3	C	D1	D2E	D2T	D2	D3L	D3	D4D	D4
L	2.0	2.0	3.2	3.5	3.5	3.5	3.5	3.5	6.0	6.0	6.0	6.0	7.3	7.3	7.3	7.3	7.3	7.3	7.3	7.3
W	1.25	1.25	1.6	2.8	2.8	2.8	2.8	2.8	3.2	3.2	3.2	3.2	4.3	4.3	4.3	4.3	4.3	4.3	4.3	4.3
H	0.8	1.1	0.9	0.9	1.1	1.1	1.4	1.9	1.4	1.8	2.5	2.8	1.4	1.8	1.8	1.9	2.8	3.1	3.6	3.8

WV	Series	μF																			
			68	82	100	120	150	220	330	470	680	1000	1500								
2V	TPE											B2(18)									
	TPE											B2(15)*									
	TPF										D2E(6)	D2E(6)	D2E(6)								
	TPLF										D2T(7,6)	D2T(7,6)	D2T(7,6)								
2.5V	TPB				B2(70)						C(45)	D3(65)			D4(30)	D4(30)					
	TPB										B2(55)	D3L(55)	D3L(40)	D3L(40)							
	TPC			C1(70)							D2(45)	D2(40)									
	TPD													D4D(*4)	D4D(*4)	D4D(*4)					
	TPE												C2(15,12,9)								
	TPE											D2E(*3)	D2E(*3)	D2E(*3)	D3L(*2)	D4(*1)	D4(15,12)				
	TPE								B2(35)		B2(35,25,21,18)	B2(35)									
	TPE											B2(15)*	C3(*1)								
	TPF												D3L(7)	D3L(10,7)	D3L(10,7,6)						
	TPG											B1G(70)									
	TPL											D2T(12)	D2T(12,9,8,7)	D2T(12,9,8,7)							
TPU					A09(150)																
3.15V	TPU				A09(150)																
4V	TPB								C(45)	C(45)					D4(40)	D4(35)					
	TPB		B2(70)			B2(70,45)			B2(70)	D3(65)											
	TPB									D3L(55)	D3L(40)	D3L(40)									
	TPC									C1(55)	D2(45)	D2(40)									
	TPC																				
	TPD															D4D(10)					
	TPE										D2E(25,18)	D2E(*1)	D2E(25,18)	D3L(*2)	D4(*1)						
	TPE					B2(35)			B2(35,30)	B2(35)											
	TPE											C2(18,15)									
	TPE											C3(25,18)									
	TPF												D3L(12)	D3L(10)							
	TPG											B1G(70)	B15G(70)								
	TPU		B09(70)																		
	TPU		A09(150)																		
	APC																				
APD																					
6.3V	TPB		B2(70)			B2(55,45)				D3(55)											
	TPB									D3L(55)	D3L(40)	D3L(40)									
	TPB									C(45)			D4(40)	D4(35)							
	TPC		C1(55)			C1(55)															
	TPC					D2(45)							D2(40)								
	TPD														D4D(10)						
	TPE					D2E(25,18)				D2E(25,18)	D2E(25,18)	D2E(25)	D3L(25,18)	D4(25,18)	D4(25,18)						
	TPE										C3(25)	D2E(25)	D3L(25,18)								
	TPE											C2(25,18)	C3(25)								
	TPE						B2(35,25)	B2(35)	B2(35)												
	TPF												D3L(12)	D3L(9)							
	TPG		B1G(70)			B1G(70)							B15G(70)								
	TPU																				
	TPU																				
APC																					
APD																					
8V	TPB					C(45)															
	TPC												D2(40)								
	TPE																				
	TPG																				
	TPU																				
10V	TPB																				
	TPB																				
	TPC																				
	TPE																				
	TPF																				
	TPG																				
TPU																					
12.5V	TPC																				
	TPG																				
16V	TQC																				
	TQC																				
20V	TQC																				
25V	TQC																				

POSCAP is uniquely structured solid electrolytic capacitor.

Please note the following points in order to take full advantage of the POSCAP's performance and ensure the most stable quality possible.

■ Crucial Precautions

(1) Polarity

POSCAP is a conductive polymer capacitor with positive and negative electrodes. Do not reverse the polarity when using. If it is used with the polarities reversed, increased leakage current or a short circuit may result.

(2) Prohibited circuits

Since problems can be expected, the POSCAP cannot be used on the following circuits.

- (1) High impedance voltage retention circuits
- (2) Coupling circuits
- (3) Time constant circuits
- (4) Circuits greatly affected by leakage current
- (5) The circuit in which two or more POSCAP are connected in a series so as to raise the endurance voltage.

(3) Over voltage prohibited during design

Over voltage exceeding the rated voltage may not be applied even for an instant as it may cause a short circuit.

(4) Sudden charge and discharge restricted

Sudden charge and discharge are restricted (for maintainance of high-proof reliability).

A protection circuit is recommended for when a sudden charge or discharge causes excessive rush current since this is main cause of short circuit and large leakage current.

Use protection circuits in case the rush current value exceeds 20A.

Be sure to insert a protection resistor of about 1kΩ for charge and discharge when measuring the leakage current.

(5) Considerations when soldering

The soldering conditions are to be within the range prescribed in this delivery specification. If the specifications are not followed, there is the possibility of the appearance becoming defective when soldering is conducted under conditions that are harsher than those stipulated.

(6) Considerations when using in industrial equipment

To insure reliability when POSCAP is used in industrial equipment, allow wider margin of capacitance, impedance and other characteristics.

(7) Using in equipment regarding human life

In case of using in equipment regarding human life (e.g. Space equipment, aeronautic equipment, military equipment and atomic equipment etc.), be sure to talk over the matter with SANYO.

Don't use without a recognition document of SANYO.

■ Circuit designing cautions

(1) Check the rated performance

After checking the operation and installation environments, design the circuit so that it falls within the rated performance range stipulated in this delivery specification.

(2) Operating temperature and ripple current

(a) Set the operating temperature so that it falls within the range stipulated in this delivery specification.

(b) Do not supply current that exceeds the allowable ripple current. When excessive ripple current is supplied, internal heat increases and reduces the POSCAP's life span.

(3) Leakage current

Even when the soldering conditions fall within the range of this delivery specifications, leakage current increases a little on occasion. It also increases a little during high temperature storage, high humidity storage and temperature cycling with no voltage applied. In cases such as these, leakage current will decrease by applying voltage under the condition of below the POSCAP's maximum operating temperature. The speed at which the leakage current is restored is increased by applying voltage when the POSCAP's temperature is close to the maximum operating temperature.

(4) Applied voltage for designing

- (a) Less than 90% of the rated voltage or category voltage is recommended. If the rated voltage is 10V, and over less than 80% of the rated voltage or category voltage is recommended.
- (b) The sum of the DC voltage plus the peak AC voltage shall not exceed the rated voltage or category voltage.
- (c) The sum of the DC voltage plus the negative peak AC voltage shall not allow a voltage reversal.

(5) Reduction of failure stress

When POSCAP is used within the rated voltage, it shows a stable characteristic, but it may be damaged in a short circuit when an overvoltage, for instance, is applied.

The time to reach the failure mode can be extended by using POSCAP with reduced ambient temperature, ripple current and applied voltage.

[Failure rate]

- In the case of the endurance which is 105°C×2,000h.
0.5%/1,000h (Environment temp. : 105°C, Rated voltage or Category voltage applied)
- In the case of the endurance which is 105°C×1,000h or 125°C×1,000h.
1.0%/1,000h (Environment temp. : 105°C, Rated voltage or Category voltage applied)
- In the case of the endurance which is 85°C×1,000h.
1.0%/1,000h (Environment temp. : 85°C, Rated voltage applied)

(6) Operating environment restrictions

Do not use the POSCAP in the following environments.

- (a) Places where water, salt water or oil can directly fall on it and places where condensation may form.
- (b) Places filled with noxious gas for capacitors (hydrogen sulfide, sulfuric acid, chlorine, ammonia, etc.).
- (c) Places susceptible to ozone, ultraviolet rays and radiation.

(7) Land pattern

When mounting the POSCAP on the PC board, match the POSCAP's land pattern dimension. (See P16.)

(8) Parallel connection

A large amount of ripple current may be applied to the POSCAP when it is used in parallel connection with another capacitor.

Carefully select the type of capacitor.

(9) Protect circuit

The failure mode of POSCAP is the short mode. When it breaks down, short electric current flows to it. POSCAP gives off heat by this short current. Do the following consideration in design fully for the safety because it has a bad influence on the part around POSCAP due to this heat.

: A protection circuit and a protection device are set up, and it is made safer as a system.

: A diffuse circuit and so on is set up, and a safe system is taken so that a machine may not break down as to the single trouble.

(10) Others

Design circuits after checking the following items.

Electrical characteristics are affected by temperature and frequency fluctuations.

Design circuits after checking the amount of fluctuation.

We are confident that the practical configurations and examples listed in this document will ensure the maximum benefit from the characteristics and performance features of our products and that these application examples are accurate and reliable. However, we cannot accept any liability for any problems in connection with industrial property rights and concerning any difficulties arising in the use of these circuits. It should also be noted that as part of our ongoing policy of product improvement, the specifications given herein may be changed or modified at any time without prior notice. Copyright, All or portions of this publication are protected against copying or other reproduction.

Company name of a mention and product name are the trademark of each company or trade mark.

Storage Conditions

It is necessary to set an environment to prevent a trouble at the time of soldering by the degradation of solder ability or moisture's getting into the molding resin when POSCAP are stored.

- (1) Please make the storage of POSCAP sealing up in the reel and storage bag.
- (2) Do not store the POSCAP at high temperature and high humidity.
Store it in a location that is not subject to direct sunlight, has temperatures less than 35°C (Generally 15 to 35°C), and relative humidity less than 75%RH (45 to 75%RH) generally.
- (3) The storage period is one year or shorter under the condition that it is unopened the storage bag.
(TQC series : 9 months from the pass mark on the label)
- (4) Do not store the POSCAP in damp conditions such as with water, salt spray, or oil spray, and dew condensation.
- (5) Do not store the POSCAP in places filled with noxious gas (hydrogen sulfide, sulfurous acid, nitrous acid, chlorine, ammonia, etc.).
- (6) Do not store the POSCAP in places susceptible to ozone, ultraviolet rays and radiation.
- (7) Please unseal storage bag just before mounting and be conscious that POSCAP not remain. When remainder occurs reluctantly, return them to storage bag once again and, please seal the unsealing division by adhesive tape etc., including desiccants. More over, once open the storage bag, it should be followed the table of (8)'s Floor Life "Time" and "conditions".
- (8) The moisture level of POSCAP is the following.

LEVEL	Floor Life		Applicable scope	
	Time	Conditions	Size code	Series
2a	4 weeks	≤ 30°C/60%RH	D2E,D2,D2T, D3L,D3,D4,D4D	TPB,TPC,TPE,TPD, TH*,TPL,TPLF
3	168hours	≤ 30°C/60%RH	S08,S11,A09,B09, B1,B1G,B15G,B2,C1,C3,C,C2	TPB,TPC,TPE,TPG, TPU,TA,TQC (All sizes)
4	72hours	≤ 30°C/60%RH	D2	APC
5	48hours	≤ 30°C/60%RH	D1,D2E,D2,D3L,D4	TH,APD

NOTE:The model of MSL "2a" is changed into MSL "3" with the 260°C reflow soldering.

(Conform to IPC/JEDEC J-STD-020C)
★Use at 105°C or less

Compensation coefficient of maximum allowable ripple current

It takes advantage in ripple current value of characteristics list and the following coefficient.

(For questions regarding TQC series, please ask separately.)

Frequency compensation coefficient

(TPB,TPC,TPD,TPE,TPF,TPG,TPL,TPLF,TPU,TA,THseries)

	120Hz≤f<1kHz	1kHz≤f<10kHz	10kHz≤f<100kHz	100kHz≤f<1MHz
22μF≤C≤100μF	0.20	0.60	0.85	1.00
100μF≤C≤330μF	0.25	0.70	0.85	1.00
330μF≤C≤1000μF	0.30	0.75	0.90	1.00

Temperature compensation coefficient

(TPB,TPC,TPD,TPE,TPF,TPG,TPL,TPLF,TPU,TA,TH,APseries)

	Case size code	
	S08, S11, A09, B09, B1,B1G,B15G, B2, C, C1, C2, C3, D2, D2E, D2T, D3L, D3, D4(THD), D4D	D4
T≤45°C	1.00	1.00
45°C<T≤85°C	0.70	0.50
★85°C<T≤105°C	0.25	0.25

T :Environment temperature
★THseries :85°C<T≤125°C

■ RoHS Compliance

POSCAP is compliant to the RoHS Directive(2002/95/EC),

Restricted substances of RoHS directive

Substance
Lead (Pb) and it's compounds
Cadmium (Cd) and it's compounds
Mercury (Hg) and it's compounds
Hexavalent chromium (Cr6+)
Polybrominated biphenyls (PBBs)
Polybromineted diphenyl ethers (PBDEs)

■ Lead-Free Status

All complete parts and homogenous materials of POSCAP are lead-free.

■ Halogen-Free

TPG, TPL and TPU series are the halogen-free products which use non-halogen material as molding resin.

We are planning to remove halogenated material from other series, too.

★ Halogen-free POSCAP is also compliant with RoHS directive and lead-free.

C, C1, D2, D3, D4 size (TPB, TPC, TH series)
 C, D2, D3L size (TQC series)
 D1, D2 size (APC, APD series)

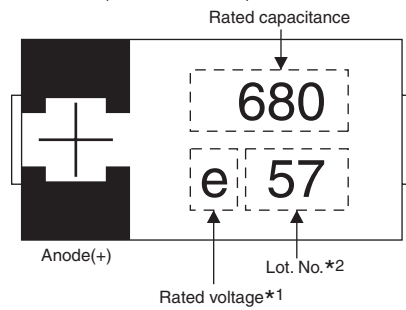

C2, C3, D2E, D3L size (TPB, TPE, TPF series)
 D4, D4D size (TPD, TPE series)

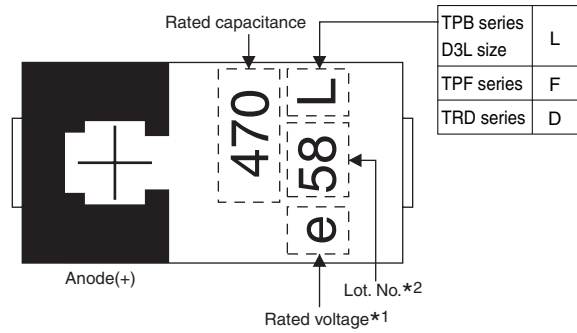

B09, B1, B1G, B15G, B2 size
 (TPB, TPG, TPU, TQC series)

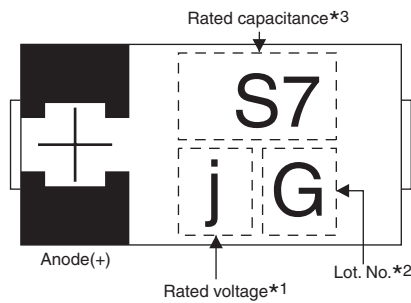

B2 size (TPE series)

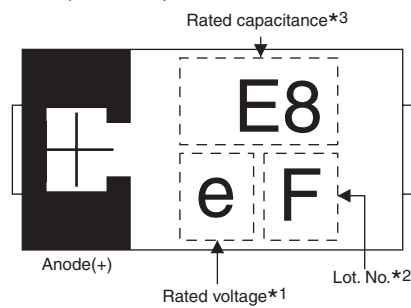

S08, S11, A09 size (TPU series)

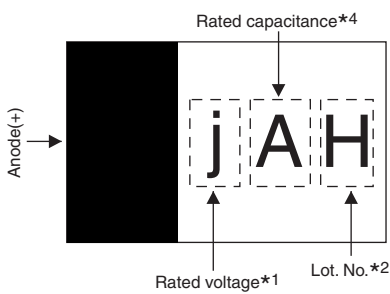

D2T size (TPL, TPLF series)

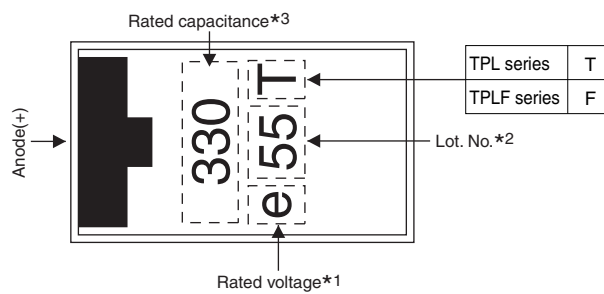

*1 The rated voltage is as follows.

R.V.	2.0	2.5	3.15	4.0	6.3	8.0	10	12.5	16	25
Mark	d	e	f	g	j	K	A	B	C	1E(orE)

*2 Lot.No.shows roughly manufacturing date.

*3 The rated capacitance is as follows.

Capacitance(μF)	5.6	8.2	10	22	33	47	56	68	100	120	150	220	330
Mark	U6	Y6	A7	J7	N7	S7	U7	W7	A8	C8	E8	J8	N8

*4 The rated capacitance is as follows.

R. Cap.(μF)	10	15	22	33	47	68	100
Mark	A	E	J	N	S	W	A

Use the following example to define POSCAP part numbers.

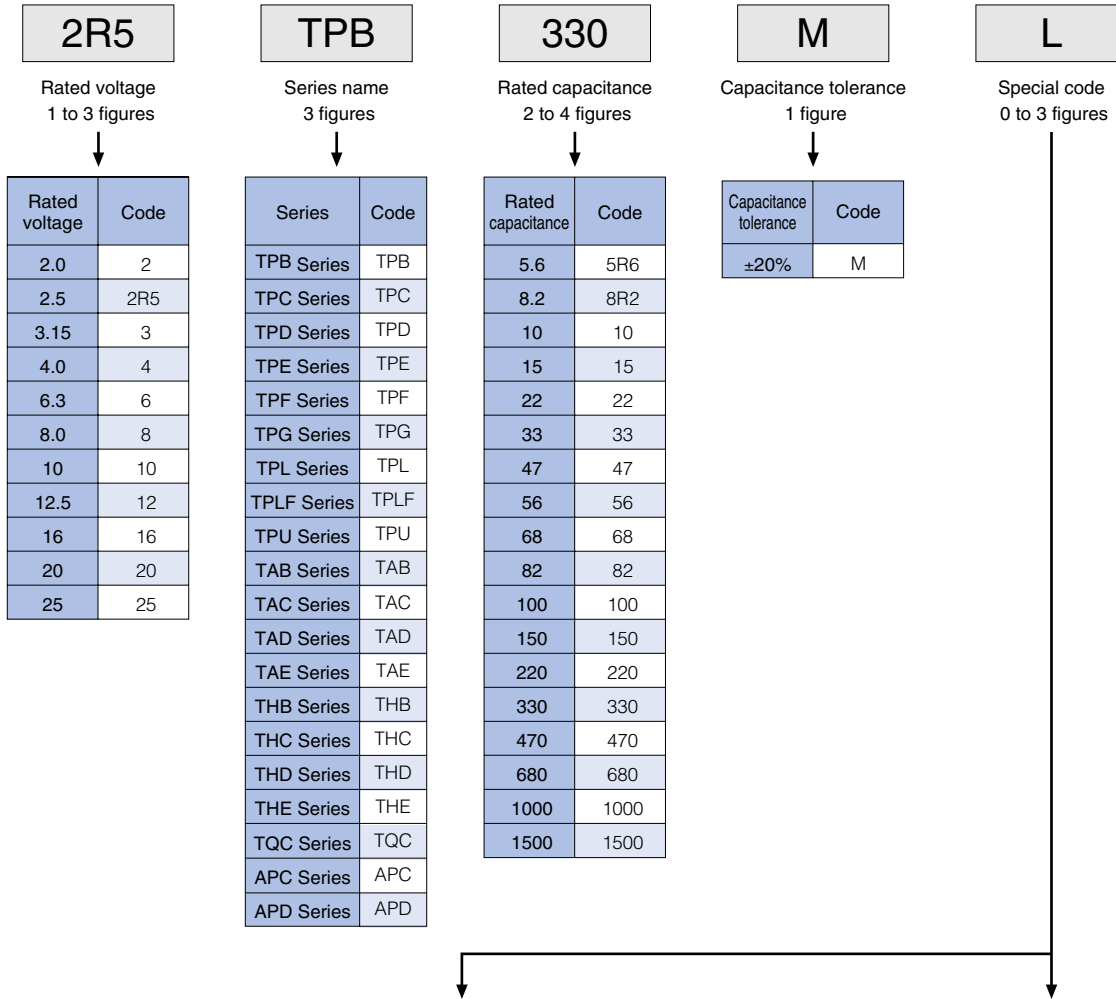

Standard		Code	
TPE Series			
B2 size	ESR 35mΩ Max.	ZB	
	ESR 30mΩ Max.	UB	
	ESR 25mΩ Max.	PB	
	ESR 21mΩ Max.	LB	
	ESR 18mΩ Max.	IB	
	ESR 15mΩ Max.	FB	
	ESR 15mΩ /300KHz Max.	FGB	
	ESR 35mΩ Max. 85°C	AZB	
	ESR 30mΩ Max. 85°C	AUB	
	ESR 25mΩ Max. 85°C	APB	
	ESR 15mΩ Max. 85°C	AFB	
	ESR 15mΩ /300KHz Max. 85°C	AFGB	
	C2 size	ESR 25mΩ Max.	PC2
		ESR 18mΩ Max.	IC2
ESR 15mΩ Max.		FC2	
ESR 12mΩ Max.		CC2	
ESR 9mΩ Max.		9C2	
C3 size	ESR 55mΩ Max.	GC	
	ESR 35mΩ Max.	ZC	
	ESR 25mΩ Max.	PC	
	ESR 18mΩ Max.	IC	
	ESR 15mΩ Max.	FC	
D2E size	ESR 25mΩ Max. 85°C	AP	
D3L size	ESR 25mΩ Max.	L	
	ESR 18mΩ Max.	IL	
	ESR 15mΩ Max.	FL	
	ESR 12mΩ Max.	CL	

Standard		Code
TPB Series		
B2 Size	85°C	A
	ESR 45mΩ Max.	V
	ESR 45mΩ Max. 85°C	AV
C size		C
D3L size		L
TPC Series		
B1 size		B
C1 size		C
TPF Series		
D3L Size	ESR 9mΩ Max.	9L
	ESR 7mΩ Max.	7L
TPU Series		
S11 size		SK
A09 size		AI
B09 size		BI
All Series		
ESR 45mΩ Max.		V
ESR 35mΩ Max.		Z
ESR 18mΩ Max.		I
ESR 15mΩ Max.		F
ESR 12mΩ Max.		C
ESR 9mΩ Max.		9
ESR 8mΩ Max.		8
ESR 6mΩ Max.		6
ESR 5mΩ Max.		5

TPB, TPC, TPE, TPF, TQC, TA, TH series

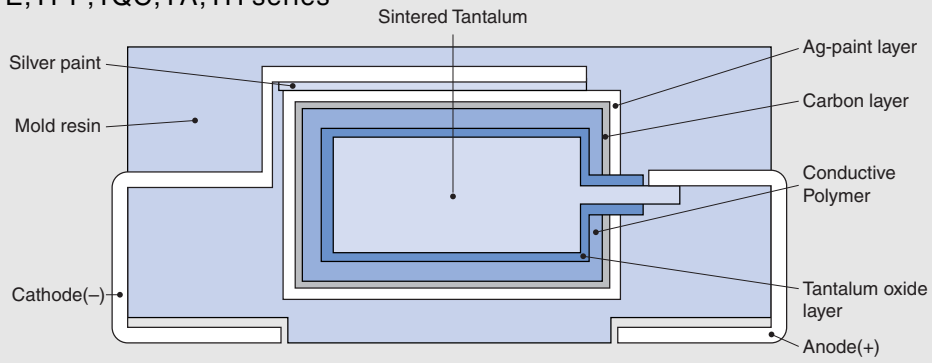

TPL, TPLF series

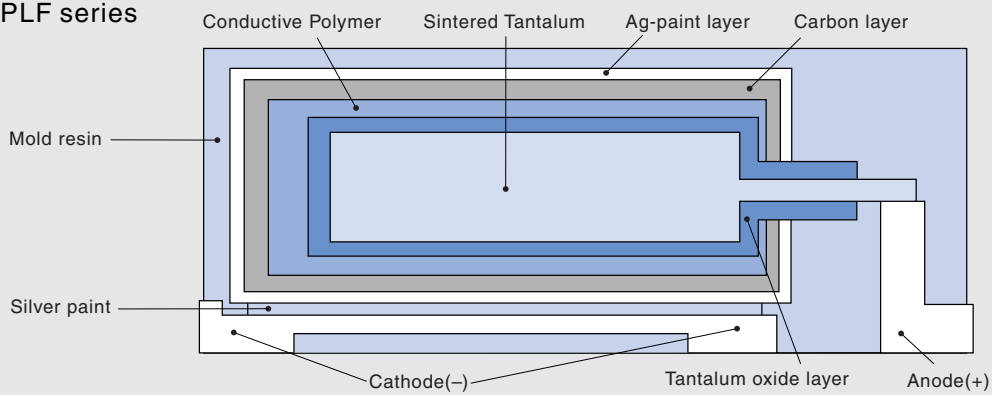

TPU series

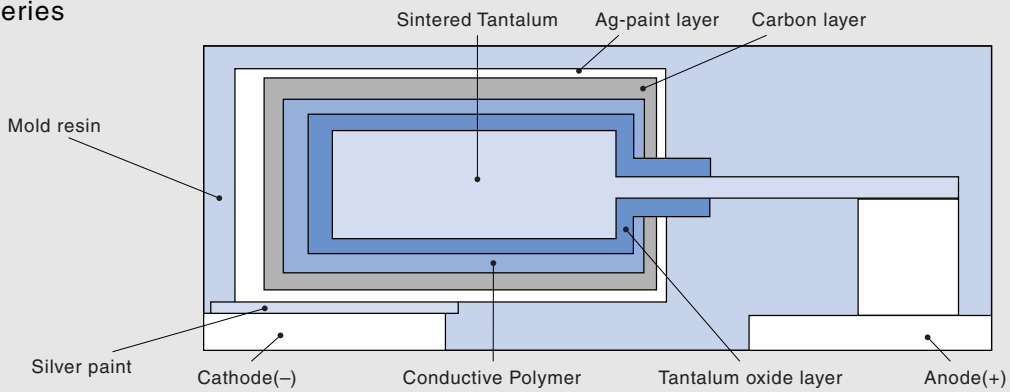

AP series

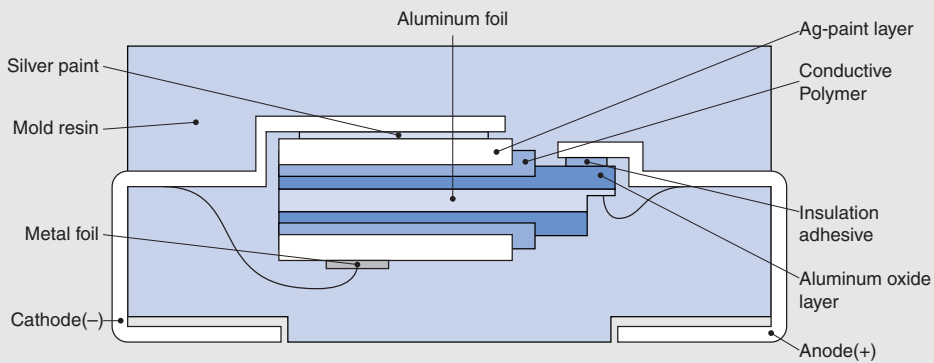

★We supply only embossed tapping type.

Dimension of carrier tape

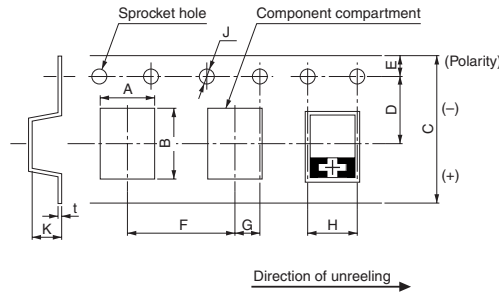

(unit:mm)

Size code	A	B	C	D	E	F	G	H	J	K	t
	±0.1	±0.1	±0.3	±0.1	±0.1	±0.1	±0.1	±0.1	+0.1 -0	±0.2	±0.1
S08	1.65	2.4	8.0	3.5	1.75	4.0	2.0	4.0	φ1.5	1.0	0.25
S11	1.45	2.25	8.0	3.5	1.75	4.0	2.0	4.0	φ1.5	1.3	0.25
A09	2.05	3.65	8.0	3.5	1.75	4.0	2.0	4.0	φ1.5	1.3	0.25
B09	3.2	3.8	8.0	3.5	1.75	4.0	2.0	4.0	φ1.5	1.4	0.2
B1	3.2	3.8	8.0	3.5	1.75	4.0	2.0	4.0	φ1.5	1.4	0.2
B1G	3.25	3.9	8.0	3.5	1.75	4.0	2.0	4.0	φ1.5	1.7	0.25
B15G	3.25	3.9	8.0	3.5	1.75	4.0	2.0	4.0	φ1.5	1.7	0.25
B2	3.3	3.8	8.0	3.5	1.75	4.0	2.0	4.0	φ1.5	2.1	0.2
C1	3.7	6.4	12.0	5.5	1.75	8.0	2.0	4.0	φ1.5	1.7	0.3
C2	3.7	6.4	12.0	5.5	1.75	8.0	2.0	4.0	φ1.5	2.1	0.3
C3	3.7	6.4	12.0	5.5	1.75	8.0	2.0	4.0	φ1.5	2.9	0.3
C	3.7	6.4	12.0	5.5	1.75	8.0	2.0	4.0	φ1.5	3.2	0.3
D1	4.55	7.65	12.0	5.5	1.75	8.0	2.0	4.0	φ1.5	1.6	0.3
D2E	4.5	7.5	12.0	5.5	1.75	8.0	2.0	4.0	φ1.5	2.4	0.3
D2T	4.5	7.8	12.0	5.5	1.75	8.0	2.0	4.0	φ1.5	2.4	0.3
D2	4.5	7.5	12.0	5.5	1.75	8.0	2.0	4.0	φ1.5	2.4	0.3
D3L	4.5	7.7	12.0	5.5	1.75	8.0	2.0	4.0	φ1.5	3.2	0.3
D3	4.5	7.5	12.0	5.5	1.75	8.0	2.0	4.0	φ1.5	3.5	0.3
D4	4.5	7.7	12.0	5.5	1.75	8.0	2.0	4.0	φ1.5	4.2	0.3
D4D	4.5	7.7	12.0	5.5	1.75	8.0	2.0	4.0	φ1.5	4.2	0.3

- Dimension A and B are the measure of compartment's inside bottom.
- The (+) Polarity of the chip is placed on right side towards the unreeling direction.
- Dimension of the topcover tape
 Thickness of cover tape: 62±10μm
 Width of cover tape: 9.5±0.2mm
 5.5±0.2mm (φ180reel)

Reel dimension

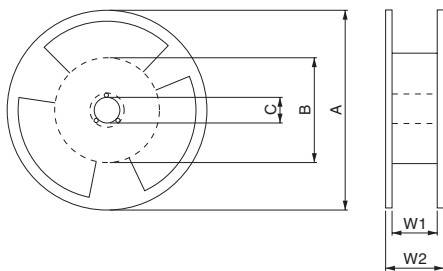

(unit:mm)

A	B	C	W1	W2
φ330±2	φ80±2	φ13±0.2	13.5±0.5	17.5±1.0
φ180±0.3	φ60±2	φ13±0.2	9±0.5	11.4±1.0

Packing quantities

Size code	Pieces/reel(φ180)	Pieces/reel(φ330)
S08	4000	—
S11	3000	—
A09	3000	—
B09	3000	—
B1	3000	—
B1G	2500	—
B15G	2500	—
B2	2000	—
C1	—	4000
C2	—	3000
C3	—	2500
C	—	2500
D1	—	3000
D2E	—	3000
D2T	—	3000
D2	—	3000
D3L	—	2500
D3	—	2500
D4	—	2000
D4D	—	2000

Dimension of packing case

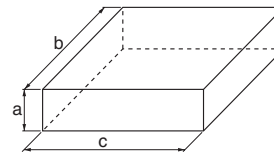

(unit:mm)

Reel size	φ180	φ330
a	90	120
b	240	360
c	240	360

Units per packing case

Size code	Pieces/case
S08	20000
S11	15000
A09	15000
B09	15000
B1	15000
B1G	12500
B15G	12500
B2	10000
C1	20000
C2	15000
C3	12500
C	12500
D1	15000
D2E	15000
D2T	15000
D2	15000
D3L	12500
D3	12500
D4	10000
D4D	10000

■ Except for TPL/TPLFseries

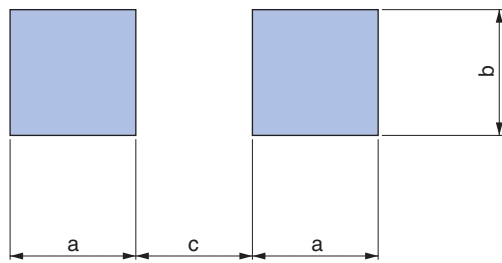

(unit:mm)

Size code	a	b	c
S08	1.0	0.9	0.6
S11	1.0	0.9	0.6
A09	1.6	1.2	1.2
B09	1.6	2.7	1.4
B1	1.6	2.7	1.4
B1G	1.6	2.7	1.4
B15G	1.6	2.7	1.4
B2	1.6	2.7	1.4
C1	2.4	2.3	2.4
C2	2.4	2.3	2.4
C3	2.4	2.3	2.4
C	2.4	2.3	2.4
D1	2.4	2.9	3.7
D2E	2.4	2.9	3.7
D2	2.4	2.9	3.7
D3L	2.4	2.9	3.7
D3	2.4	2.9	3.7
D4	2.4	2.9	3.7
D4D	2.4	2.9	3.7

■ TPL/TPLFseries

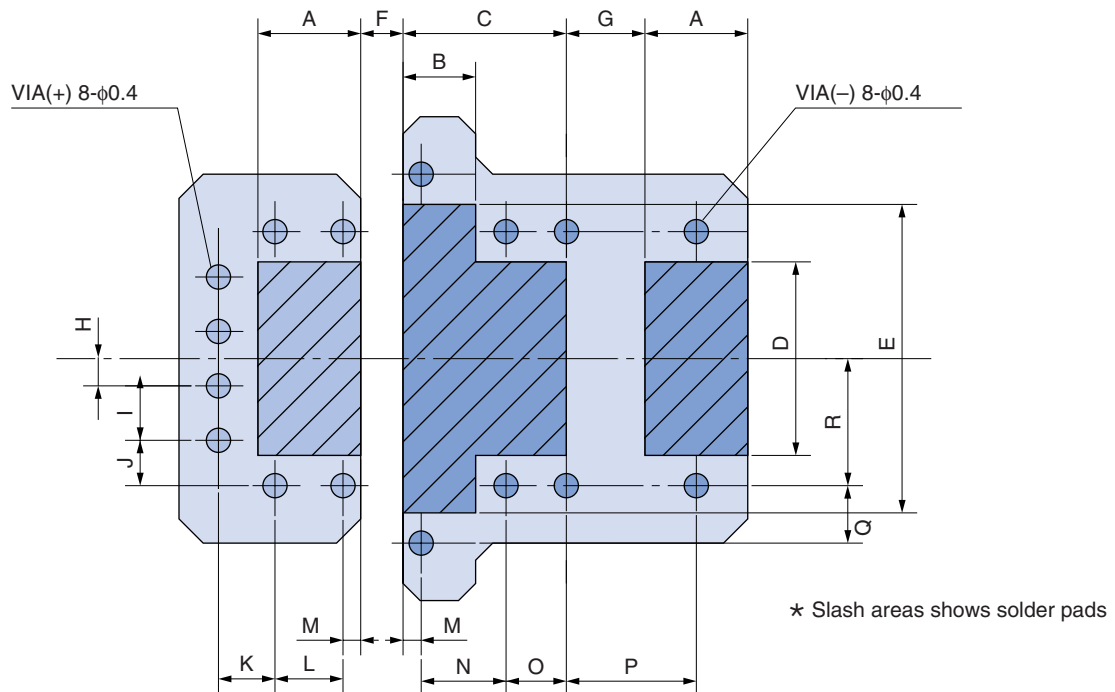

(1) Three-pad design for three-terminal model (TPL/TPLF series)

(unit:mm)

Size code	A	B	C	D	E	F	G	H	I	J	K	L	M	N	O	P	Q	R
D2T	1.7	1.2	2.7	3.2	5.1	0.7	1.3	0.45	0.9	0.75	0.9	1.1	0.3	1.4	1.0	2.15	0.95	2.1

(2) Common three-pad design for POSCAP D-size two-terminal model

Size code	A	B	C	D	E	F	G	H	I	J	K	L	M	N	O	P	Q	R
D common	2.2	1.2	2.7	2.9	5.1	0.5	1.0	0.45	0.9	0.75	1.4	1.1	0.3	1.4	1.0	2.15	0.95	2.1

Recommended reflow soldering temperature profile

The cycles of reflow soldering: Twice (Max.)

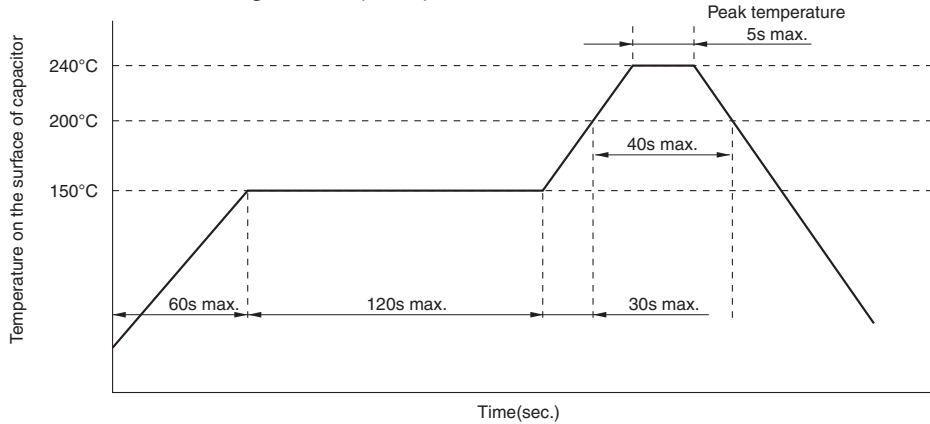

Peak temperature 250°C lead free reflow soldering profile

The cycles of reflow soldering: Twice (Max.)

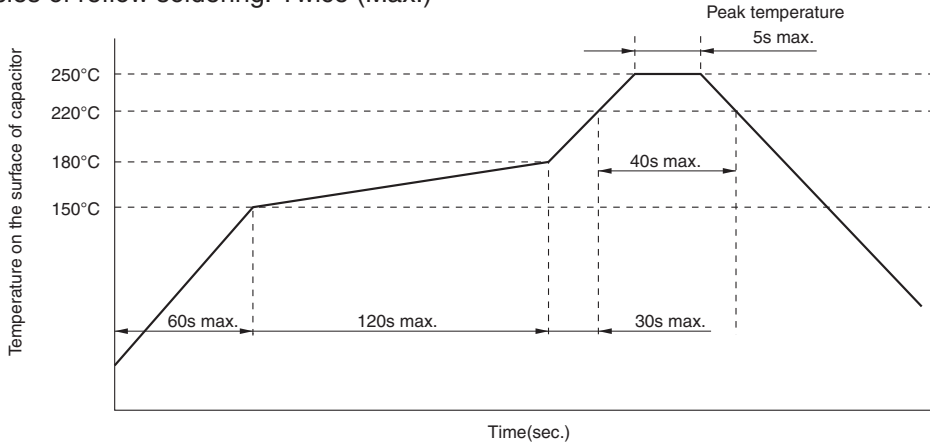

Peak temperature 260°C lead free reflow soldering profile

· The model of MSL"2a" is changed into MSL "3" with this reflow condition.(See P10)

The cycles of reflow soldering: Twice (Max.)

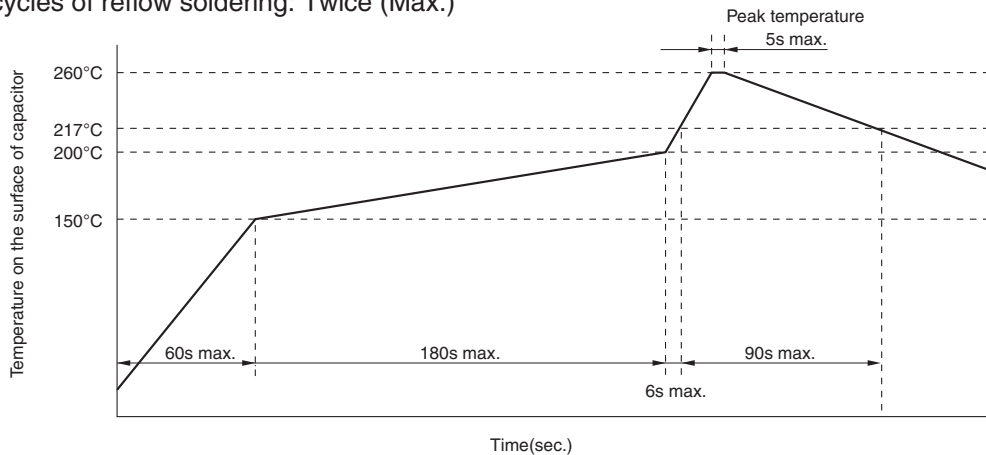

Soldering with a soldering iron

Tip of a soldering iron: 350°C Max. Power of a soldering iron: 30W Max. Working time: 3sec. Max.
 (Do not let the tip of soldering iron touch the POSCAP itself. Do not subject the POSCAP itself to excessive stress when soldering.)

Temperature Characteristics

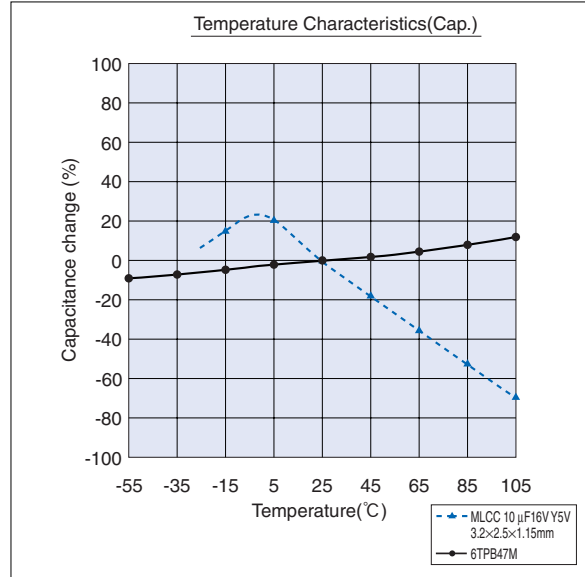
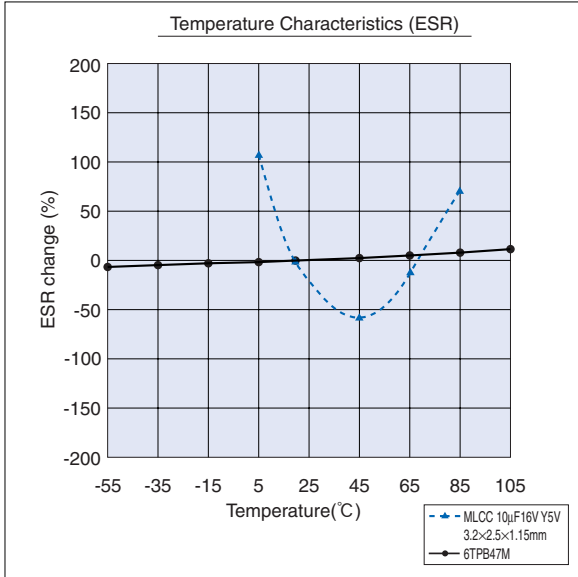

Bias voltage Characteristics

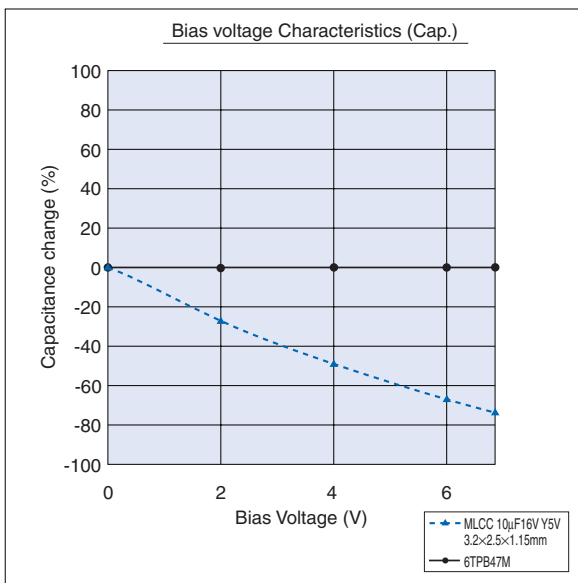

Frequency Characteristics

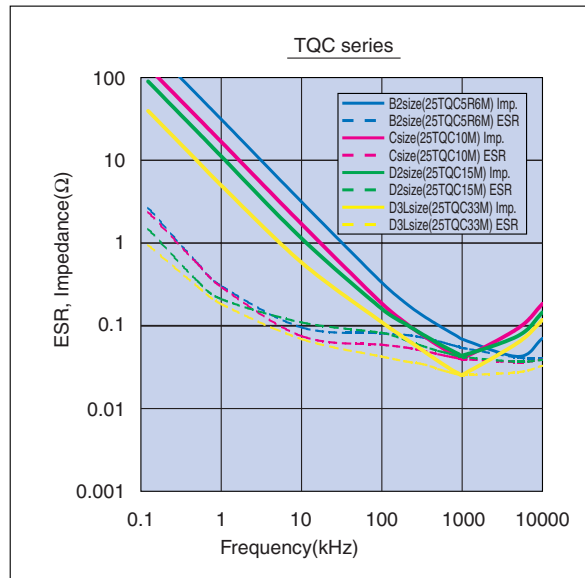
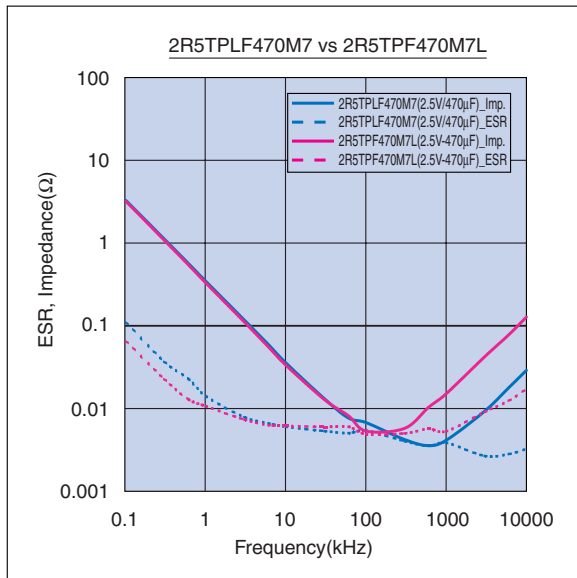
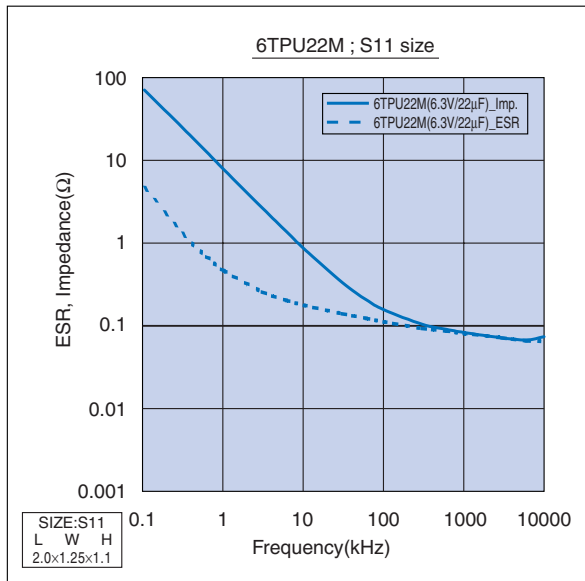
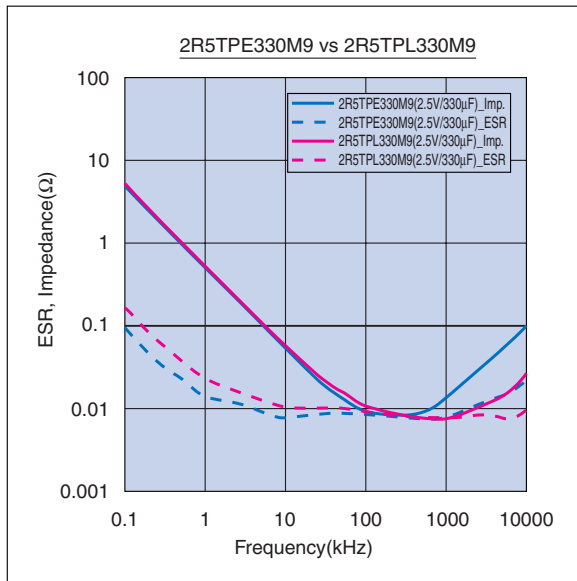
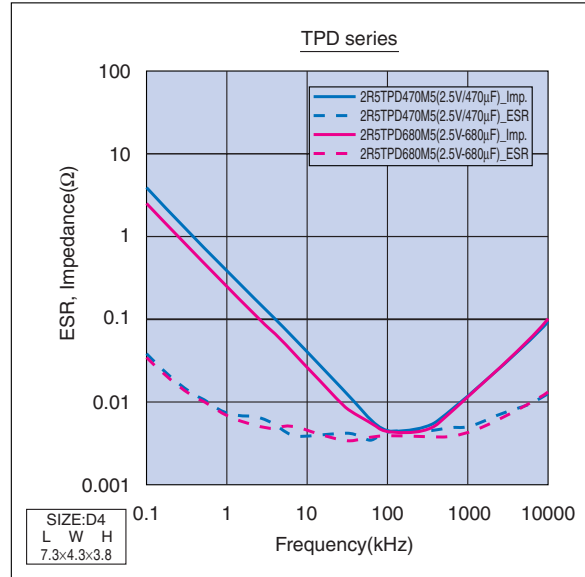
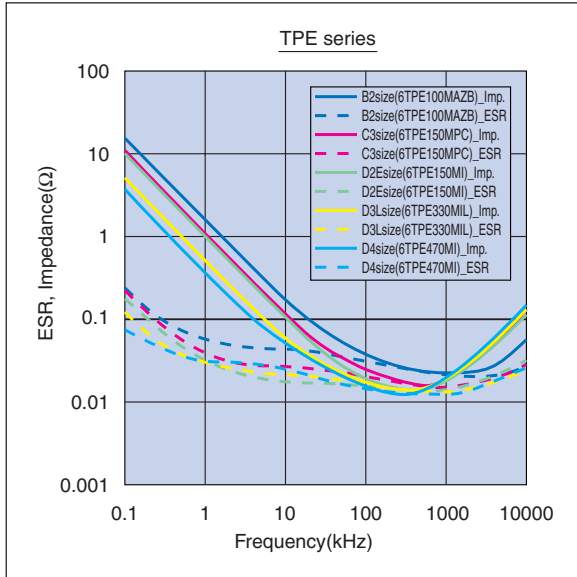

TPB Series Standard Products

Feature

TPB series are the standard products corresponding to the diversification of the needs.



Specifications

Items	Condition	Characteristics		
Operating Temperature range	—	-55 to +105 (°C)		
Rated capacitance range	120Hz/20°C	47 to 1000 (μF)		
Capacitance tolerance	120Hz/20°C	M:±20%		
Rated voltage	—	2.5 to 10.0 (V.DC)		
Dissipation Factor (D.F.)	120Hz/20°C	≤ 8.0 or 10.0 or 15.0 (%)		
Leakage current	Rated voltage applied, after 5 minutes	≤ 0.1CV (μA)		
Equivalent series resistance (E.S.R. mΩmax.)	100kHz/20°C	Please see the attached characteristics list		
Temperature characteristics of Impedance ratio	100kHz/+20°C	-55°C	Z/Z _{20°C}	1.0 to 2.0
		+105°C	Z/Z _{20°C}	0.6 to 1.0
Endurance	105°C,2000h, rated voltage applied	ΔC/C	Within±20% of the initial value	
		D.F.	≤ 1.5 times the initial limit	
		L.C.	≤ The initial limit	
Damp heat (Steady state)	60°C,90 to 95%RH,500h, No voltage applied	ΔC/C	Within+50%, -20% of the initial value (2R5TPB1000M)	
			Within+40%, -20% of the initial value (Except for the above model)	
		D.F.	≤ 1.5 times the initial limit	
Surge	105°C,1000 cycles, 1kΩdischarge resistance, surge voltage applied	L.C.	≤ 3 times the initial limit	
		ΔC/C	Within±5% of the initial value	
		D.F.	≤ The initial limit	
		L.C.	≤ 3 times the initial limit	

Dimensions

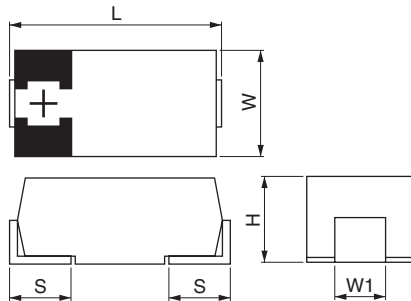

(unit: mm)

Size code	L*1 (±0.2)	W (±0.2)	H (±0.2)	S (±0.2)	W1 (±0.1)
C	6.0	3.2	2.8	1.3	1.8
D3L	7.3	4.3	2.8	1.3	2.4
D3	7.3	4.3	3.1	1.3	2.4
D4	7.3	4.3	3.8	1.3	2.4

*1 ±0.3:D3L,D4

Size List

RV (SV)	2.5 (3.2)	4.0 (5.0)	6.3 (8.0)	8.0 (10.0)	10.0 (13.0)
47					C
68					C
82				C	
100			C		D3,D3L
150		C	C,D3,D3L		D3L
220	C	C,D3,D3L	D3L		D3L,D4
330	D3,D3L	D3L	D3L,D4		D4
470	D3L	D4,D3L	D4		
680	D4,D3L	D4			
1000	D4				

Characteristics List

Size code	SANYO Part number	Rated Voltage (V)	Rated Temperature (°C)	Rated Capacitance (μF)	Category Voltage (V)	Category Temperature (°C)	D.F. (%max.)	L.C. (μA) max./5min.	E.S.R. (mΩmax.) 100kHz/20°C	Maximum allowable ripple current (mA rms) 100kHz*1	MSL	
											Reflow Temp. ≤ 260°C	Reflow Temp. ≤ 250°C
C	10TPB68MC	10.0	105	68	10.0	105	8.0	68.0	55	1500	3	2a
	10TPB47MC	10.0	105	47	10.0	105	8.0	47.0	55	1500		
	8TPB82MC	8.0	105	82	8.0	105	8.0	65.6	45	1700		
	6TPB150MC	6.3	105	150	6.3	105	8.0	94.5	45	1700		
	6TPB100MC	6.3	105	100	6.3	105	8.0	63.0	45	1700		
	4TPB220MC	4.0	105	220	4.0	105	8.0	88.0	45	1700		
	4TPB150MC	4.0	105	150	4.0	105	8.0	60.0	45	1700		
	2R5TPB220MC	2.5	105	220	2.5	105	8.0	55.0	45	1700		
D3L	10TPB220ML	10.0	105	220	10.0	105	10.0	220.0	40	2000		
	10TPB150ML	10.0	105	150	10.0	105	10.0	150.0	40	2000		
	10TPB100ML	10.0	105	100	10.0	105	8.0	100.0	55	1900		
	6TPB330ML	6.3	105	330	6.3	105	10.0	207.9	40	2000		
	6TPB220ML	6.3	105	220	6.3	105	10.0	138.6	40	2000		
	6TPB150ML	6.3	105	150	6.3	105	8.0	94.5	55	1900		
	4TPB470ML	4.0	105	470	4.0	105	10.0	188.0	40	2000		
	4TPB330ML	4.0	105	330	4.0	105	10.0	132.0	40	2000		
	4TPB220ML	4.0	105	220	4.0	105	8.0	88.0	55	1900		
	2R5TPB680ML	2.5	105	680	2.5	105	10.0	170.0	40	2000		
	2R5TPB470ML	2.5	105	470	2.5	105	10.0	117.5	40	2000		
	2R5TPB330ML	2.5	105	330	2.5	105	8.0	82.5	55	1900		
D3	10TPB100M	10.0	105	100	10.0	105	8.0	100.0	55	1900		
	6TPB150M	6.3	105	150	6.3	105	8.0	94.5	55	1900		
	4TPB220M	4.0	105	220	4.0	105	8.0	88.0	65	1500		
	2R5TPB330M	2.5	105	330	2.5	105	8.0	82.5	65	1500		
D4	10TPB330M	10.0	105	330	10.0	105	10.0	330.0	35	3000		
	10TPB220M	10.0	105	220	10.0	105	10.0	220.0	40	3000		
	6TPB470M	6.3	105	470	6.3	105	15.0	296.1	35	3000		
	6TPB330M	6.3	105	330	6.3	105	10.0	207.9	40	3000		
	4TPB680M	4.0	105	680	4.0	105	15.0	272.0	35	3000		
	4TPB470M	4.0	105	470	4.0	105	10.0	188.0	40	3000		
	2R5TPB1000M	2.5	105	1000	2.5	105	15.0	250.0	30	3000		
	2R5TPB680M	2.5	105	680	2.5	105	10.0	170.0	40	3000		

*1 100k to 500kHz, 45°C

TPB Series Standard Products (B2 Size)

Feature

B2 size is the miniaturized version of TPB series.

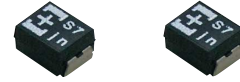

Specifications

Items	Condition	Characteristics		
Operating Temperature range	—	-55 to +105 (°C)		
Rated capacitance range	120Hz/20°C	33 to 220 (μF)		
Capacitance tolerance	120Hz/20°C	M:±20%		
Rated voltage	—	2.5 to 10 (V.DC)		
Dissipation Factor (D.F.)	120Hz/20°C	≤ 8.0 (%)		
Leakage current	Rated voltage applied, after 5 minutes	Please see the attached characteristic list		
Equivalent series resistance (E.S.R. mΩmax.)	100kHz/20°C	Please see the attached characteristic list		
Temperature characteristics of Impedance ratio	100kHz/+20°C	-55°C	Z/Z _{20°C}	1.0 to 2.0
		+105°C	Z/Z _{20°C}	0.6 to 1.0
Endurance	105°C, 1000h, rated voltage applied *Rated temp. 85°C products: 85°C, 1000h, rated voltage applied	ΔC/C	Within±20% of the initial value	
		D.F.	≤ 1.5 times the initial limit	
		L.C.	≤ The initial limit	
Damp heat (Steady state)	60°C, 90 to 95%RH, 500h, No voltage applied	ΔC/C	Within+40%, -20% of the initial value	
		D.F.	≤ 1.5 times the initial limit	
		L.C.	≤ 3 times the initial limit	
Surge	105°C, 1000 cycles, 1kΩ discharge resistance, surge voltage applied *6TPB100MA, 4TPB150MA, 2R5TPB220MA : 85°C	ΔC/C	Within±5% of the initial value	
		D.F.	≤ The initial limit	
		L.C.	≤ 3 times the initial limit	

Dimensions

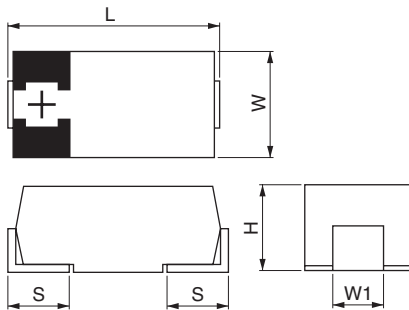

(unit: mm)

Size code	L (±0.2)	W (±0.2)	H (±0.1)	S (±0.2)	W1 (±0.1)
B2	3.5	2.8	1.9	0.8	2.2

Size List

μF \ RV (SV)	2.5 (3.2)	4.0 (5.0)	6.3 (8.0)	8.0 (10.0)	10.0 (13.0)
33				B2	B2
47			B2	B2	B2
68		B2	B2		
100	B2	B2	B2		
150		B2			
220	B2				

Characteristics List

Size code	SANYO Part number	Rated Voltage (V)	Rated Temperature (°C)	Rated Capacitance (μF)	Category Voltage (V)	Category Temperature (°C)	D.F. (%max.)	L.C. (μA) max./5min.	E.S.R. (mΩmax.) 100kHz/20°C	Maximum allowable ripple current (mArms) 100kHz*1	MSL	
											Reflow Temp. ≤ 260°C	Reflow Temp. ≤ 250°C
B2	10TPB47M	10.0	105	47	10.0	105	8.0	47.0	70	1100	3	3
	10TPB33M	10.0	105	33	10.0	105	8.0	33.0	70	1100		
	8TPB47M	8.0	105	47	8.0	105	8.0	37.6	70	1100		
	8TPB33M	8.0	105	33	8.0	105	8.0	26.4	70	1100		
	6TPB100MA	6.3	85	100	5.0	105	8.0	63.0	55	1200		
	6TPB100MAV	6.3	85	100	5.0	105	8.0	63.0	45	1400		
	6TPB68M	6.3	105	68	6.3	105	8.0	42.8	70	1100		
	6TPB47M	6.3	105	47	6.3	105	8.0	29.6	70	1100		
	4TPB150MA	4.0	85	150	3.2	105	8.0	60.0	70	1100		
	4TPB100M	4.0	105	100	4.0	105	8.0	40.0	70	1100		
	4TPB100MV	4.0	105	100	4.0	105	8.0	40.0	45	1300		
	4TPB68M	4.0	105	68	4.0	105	8.0	27.2	70	1100		
	2R5TPB220MA	2.5	85	220	2.0	105	8.0	55.0	55	1200		
	2R5TPB100M	2.5	105	100	2.5	105	8.0	25.0	70	1100		

*1 100k to 500kHz, 45°C

TPC Series Low Profile Products

Feature

TPC series has low profile and low ESR. TPC series aids in the miniaturization of any products.



Specifications

Items	Condition	Characteristics		
Operating Temperature range	—	-55 to +105 (°C)		
Rated capacitance range	120Hz/20°C	33 to 330 (μF)		
Capacitance tolerance	120Hz/20°C	M:±20%		
Rated voltage	—	2.5 to 10 (V.DC)		
Dissipation Factor (D.F.)	120Hz/20°C	≤ 10.0 (%)		
Leakage current	Rated voltage applied, after 5 minutes	Please see the attached characteristics list		
Equivalent series resistance (E.S.R. mΩmax.)	100kHz/20°C	Please see the attached characteristics list		
Temperature characteristics of Impedance ratio	100kHz/+20°C	-55°C	Z/Z _{20°C}	1.0 to 2.0
		+105°C	Z/Z _{20°C}	0.6 to 1.0
Endurance	105°C,2000h, rated voltage applied C1 size:1000h *Rated temp. 85°C products: 85°C, 2000h, rated voltage applied	ΔC/C	Within±20% of the initial value	
		D.F.	≤ 1.5 times the initial limit	
		L.C.	≤ The initial limit	
Damp heat (Steady state)	60°C,90 to 95%RH,500h, No voltage applied	ΔC/C	Within+40%, -20% of the initial value	
		D.F.	≤ 1.5 times the initial limit	
		L.C.	≤ 3 times the initial limit	
Surge	105°C,1000 cycles, 1kΩdischarge resistance, surge voltage applied *6TPC330M:85°C	ΔC/C	Within±5% of the initial value	
		D.F.	≤ The initial limit	
		L.C.	≤ 3 times the initial limit	

Dimensions

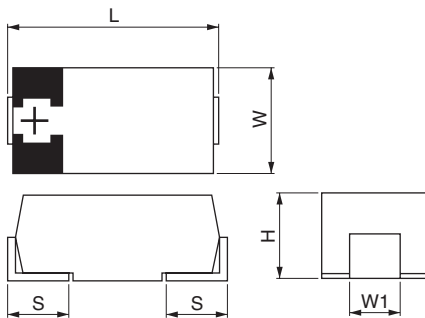

(unit: mm)

Size code	L (±0.2)	W (±0.2)	H (±0.1)	S (±0.2)	W1 (±0.1)
C1	6.0	3.2	1.4	1.3	1.8
D2	7.3	4.3	1.9	1.3	2.4

Size List

μF	RV (SV)	2.5 (3.2)	4.0 (5.0)	6.3 (8.0)	8.0 (10.0)	10.0 (13.0)
33					C1	
56			C1			
68				C1		D2
82		C1				
100			C1	D2,C1		D2
150			D2	D2	D2	
220		D2	D2			
330		D2		D2		

Characteristics List

Size code	SANYO Part number	Rated Voltage (V)	Rated Temperature (°C)	Rated Capacitance (μF)	Category Voltage (V)	Category Temperature (°C)	D.F. (%max.)	L.C. (μA) max./5min.	E.S.R. (mΩmax.) 100kHz/20°C	Maximum allowable ripple current (mA rms) 100kHz*1	MSL	
											Reflow Temp. ≤ 260°C	Reflow Temp. ≤ 250°C
C1	8TPC33M	8.0	105	33	8.0	105	10.0	26.4	70	1200	3	3
	6TPC100MC	6.3	85	100	5.0	105	10.0	63.0	55	1300		
	6TPC68M	6.3	105	68	6.3	105	10.0	42.8	55	1300		
	4TPC100M	4.0	105	100	4.0	105	10.0	40.0	55	1300		
	4TPC56M	4.0	105	56	4.0	105	10.0	22.4	70	1200		
	2R5TPC82M	2.5	105	82	2.5	105	10.0	20.5	70	1200		
D2	10TPC100M	10.0	105	100	10.0	105	10.0	100.0	45	1700	3	2a
	10TPC68M	10.0	105	68	10.0	105	10.0	68.0	45	1700		
	8TPC150M	8.0	105	150	8.0	105	10.0	120.0	40	1900		
	6TPC330MA	6.3	85	330	5.0	105	10.0	207.9	40	1900		
	6TPC150M	6.3	105	150	6.3	105	10.0	94.5	40	1900		
	6TPC100M	6.3	105	100	6.3	105	10.0	63.0	45	1700		
	4TPC220M	4.0	105	220	4.0	105	10.0	88.0	40	1900		
	4TPC150M	4.0	105	150	4.0	105	10.0	60.0	45	1700		
	2R5TPC330M	2.5	105	330	2.5	105	10.0	82.5	40	1900		
	2R5TPC220M	2.5	105	220	2.5	105	10.0	55.0	45	1700		

*1 100k to 500kHz, 45°C

TPC Series B1 Size

Feature

B1 size is miniaturized, low profile version of TPC series.

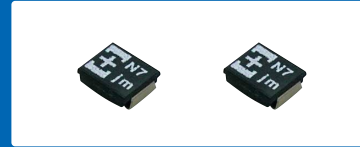

Specifications

Items	Condition	Characteristics		
Operating Temperature range	—	-55 to +105 (°C)		
Rated capacitance range	120Hz/20°C	10 to 56 (μF)		
Capacitance tolerance	120Hz/20°C	M: ±20%		
Rated voltage	—	2.5 to 12.5 (V.DC)		
Dissipation Factor (D.F.)	120Hz/20°C	≤ 10.0 (%)		
Leakage current	Rated voltage applied, after 5 minutes	Please see the attached characteristics list		
Equivalent series resistance (E.S.R. mΩmax.)	100kHz/20°C	Please see the attached characteristics list		
Temperature characteristics of Impedance ratio	100kHz/+20°C	-55°C	Z/Z _{20°C}	1.0 to 2.0
		+105°C	Z/Z _{20°C}	0.6 to 1.0
Endurance	85°C, 1000h, rated voltage applied or 105°C, 1000h, category voltage applied	ΔC/C	Within ±20% of the initial value	
		D.F.	≤ 1.5 times the initial limit	
		L.C.	≤ The initial limit	
Damp heat (Steady state)	60°C, 90 to 95%RH, 500h, No voltage applied	ΔC/C	Within +40%, -20% of the initial value	
		D.F.	≤ 1.5 times the initial limit	
		L.C.	≤ 3 times the initial limit	
Surge	85°C, 1000 cycles, 1kΩ discharge resistance, surge voltage applied	ΔC/C	Within ±5% of the initial value	
		D.F.	≤ The initial limit	
		L.C.	≤ 3 times the initial limit	

Dimensions

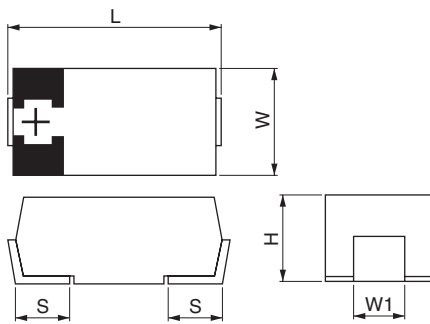

(unit: mm)

Size code	L (±0.2)	W (±0.2)	H (±0.1)	S (±0.2)	W1 (±0.1)
B1	3.5	2.8	1.1	0.8	2.2

Size List

μF	RV (sV)	2.5 (3.2)	4.0 (5.0)	6.3 (8.0)	8.0 (10.0)	10.0 (13.0)	12.5 (16.0)
10							B1
15							B1
22					B1		
33				B1		B1	
47			B1	B1			
56		B1					

Characteristics List

Size code	SANYO Part number	Rated Voltage (V)	Rated Temperature (°C)	Rated Capacitance (μF)	Category Voltage (V)	Category Temperature (°C)	D.F. (%max.)	L.C. (μA) max./5min.	E.S.R. (mΩmax.) 100kHz/20°C	Maximum allowable ripple current (mArms) 100kHz*1	MSL	
											Reflow Temp. ≤ 260°C	Reflow Temp. ≤ 250°C
B1	12TPC15M	12.5	85	15	10.0	105	10.0	18.8	80	800	3	3
	12TPC10M	12.5	85	10	10.0	105	10.0	12.5	80	800		
	10TPC33MB	10.0	85	33	8.0	105	10.0	33.0	70	1000		
	8TPC22M	8.0	85	22	6.3	105	10.0	17.6	70	1000		
	6TPC47MB	6.3	85	47	5.0	105	10.0	29.6	70	1000		
	6TPC33M	6.3	85	33	5.0	105	10.0	20.8	70	1000		
	4TPC47M	4.0	85	47	3.2	105	10.0	18.8	70	1000		
	2R5TPC56M	2.5	85	56	2.0	105	10.0	14.0	70	1000		

*1 100k to 500kHz, 45°C

TPD Series Low ESR · High Capacitance Products

Feature

TPD series has low ESR and high capacitance. It is the most suitable for the high frequency and high current switching power supply applications.



Specifications

Items	Condition	Characteristics		
Operating Temperature range	—	-55 to +105 (°C)		
Rated capacitance range	120Hz/20°C	470 to 1000 (μF)		
Capacitance tolerance	120Hz/20°C	M:±20%		
Rated voltage	—	2.5 to 6.3 (V.DC)		
Dissipation Factor (D.F.)	120Hz/20°C	≤ 10.0 (%)		
Leakage current	Rated voltage applied, after 5 minutes	Please see the attached characteristics list		
Equivalent series resistance (E.S.R. mΩmax.)	100kHz/20°C	Please see the attached characteristics list		
Temperature characteristics of Impedance ratio	100kHz/+20°C	-55°C	Z/Z _{20°C}	1.0 to 2.0
		+105°C	Z/Z _{20°C}	0.6 to 1.0
Endurance	105°C, 2000h, rated voltage applied	ΔC/C	Within±20% of the initial value	
		D.F.	≤ 1.5 times the initial limit	
		L.C.	≤ The initial limit	
Damp heat (Steady state)	60°C, 90 to 95%RH, 500h, No voltage applied	ΔC/C	Within+40%, -20% of the initial value	
		D.F.	≤ 1.5 times the initial limit	
		L.C.	≤ 3 times the initial limit	
Surge	105°C, 1000 cycles, 1kΩ discharge resistance, surge voltage applied	ΔC/C	Within±5% of the initial value	
		D.F.	≤ The initial limit	
		L.C.	≤ 3 times the initial limit	

Dimensions

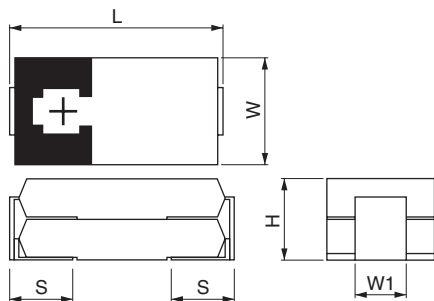

(unit: mm)

Size code	L (±0.3)	W (±0.2)	H (±0.2)	S (±0.2)	W1 (±0.1)
D4D	7.3	4.3	3.6	1.3	2.4

Size List

RV (V)	2.5 (3.2)	4.0 (5.0)	6.3 (8.0)
470	D4D		D4D
680	D4D	D4D	
1000	D4D		

Characteristics List

Size code	SANYO Part number	Rated Voltage (V)	Rated Temperature (°C)	Rated Capacitance (μF)	Category Voltage (V)	Category Temperature (°C)	D.F. (%max.)	L.C. (μA) max./5min.	E.S.R. (mΩmax.) 100kHz/20°C	Maximum allowable ripple current (mA _{RMS}) 100kHz*1	MSL		
											Reflow Temp. ≤ 260°C	Reflow Temp. ≤ 250°C	
D4D	6TPD470M	6.3	105	470	6.3	105	10.0	296.1	10	4400	3	2a	
	4TPD680M	4.0	105	680	4.0	105	10.0	272.0	10	4400			
	2R5TPD1000M	2.5	105	1000	2.5	105	10.0	250.0	max./5min.	10			4400
	2R5TPD1000M8									8			4900
	2R5TPD1000M6									6			5600
	2R5TPD1000M5									5			6100
	2R5TPD680M6									6			5600
	2R5TPD680M5	5	6100										
	2R5TPD470M6	2.5	105	470	2.5	105	10.0	117.5	max./5min.	6			5600
	2R5TPD470M5									5			6100

*1 100k to 500kHz, 45°C

TPE Series Low ESR Products (D2E, D3L, D4 Size)

Feature

TPE series has low ESR and can aid in the miniaturization of many products.



Specifications

Items	Condition	Characteristics		
Operating Temperature range	—	-55 to +105 (°C)		
Rated capacitance range	120Hz/20°C	68 to 1500 (μF)		
Capacitance tolerance	120Hz/20°C	M:±20%		
Rated voltage	—	2.5 to 10 (V.DC)		
Dissipation Factor (D.F.)	120Hz/20°C	≤ 10.0 (%) ★D4size:≤ 15.0 (%)		
Leakage current	Rated voltage applied, after 5 minutes	Please see the attached characteristics list		
Equivalent series resistance (E.S.R. mΩmax.)	100kHz/20°C	Please see the attached characteristics list		
Temperature characteristics of Impedance ratio	100kHz/+20°C	-55°C	Z/Z _{20°C}	1.0 to 2.0
		+105°C	Z/Z _{20°C}	0.6 to 1.0
Endurance	105°C,2000h, rated voltage applied ★Rated temp. 85°C products: 85°C, 1000h, rated voltage applied	ΔC/C	Within±20% of the initial value	
		D.F.	≤ 1.5 times the initial limit	
		L.C.	≤ The initial limit	
Damp heat (Steady state)	60°C,90 to 95%RH,500h, No voltage applied	ΔC/C	Within+50%, -20% of the initial value (2R5TPE470M (I.F.C.9.7), 2R5TPE330M (I.F.C.9.7), 2R5TPE220M (I.F.C.9.7), 2R5TPE1000M (I.F.), 2R5TPE1500M (F.C)) Within+40%, -20% of the initial value (Except for the above model)	
		D.F.	≤ 1.5 times the initial limit	
		L.C.	≤ 3 times the initial limit	
Surge	105°C,1000 cycles, 1kΩ discharge resistance, surge voltage applied ★6TPE330MAP,16TPE220MAP:85°C	ΔC/C	Within±5% of the initial value	
		D.F.	≤ The initial limit	
		L.C.	≤ 3 times the initial limit	

Dimensions

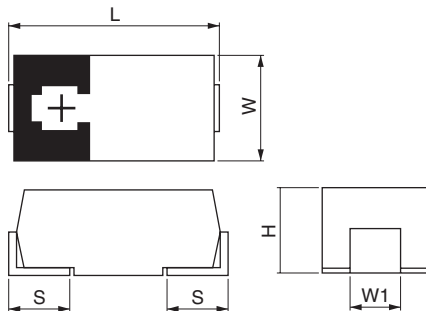

(unit: mm)

Size code	L (±0.3)	W (±0.2)	H*1 (±0.2)	S (±0.2)	W1 (±0.1)
D2E	7.3	4.3	1.8	1.3	2.4
D3L	7.3	4.3	2.8	1.3	2.4
D4	7.3	4.3	3.8	1.3	2.4

*1 ±0.1:D2E

Size List

μF	RV (sV)	2.5 (3.2)	4.0 (5.0)	6.3 (8.0)	10.0 (13.0)
68					D2E
100				D2E	
150			D2E	D2E	
220		D2E	D2E	D2E	D3L
330		D2E	D2E	D2E,D3L	D4
470		D2E	D3L	D4	
680		D3L	D4	D4	
1000		D4			

Characteristics List

Size code	SANYO Part number	Rated Voltage (V)	Rated Temperature (°C)	Rated Capacitance (μF)	Category Voltage (V)	Category Temperature (°C)	D.F. (%max.)	L.C. (μA) max./5min.	E.S.R. (mΩmax.) 100kHz/20°C	Maximum allowable ripple current (mA rms) 100kHz*1	MSL		
											Reflow Temp. ≤ 260°C	Reflow Temp. ≤ 250°C	
D2E	10TPE68M	10.0	105	68	10.0	105	10.0	68.0	25	2400	3	2a	
	6TPE330MAP	6.3	85	330	5.0	105	10.0	207.9	25	2400			
	6TPE220MAP	6.3	85	220	5.0	105	10.0	138.6	25	2400			
	6TPE220M	6.3	105	220	6.3	105	10.0	138.6	25	2400			
	6TPE220MI								18	2800			
	6TPE150M	6.3	105	150	6.3	105	10.0	94.5	25	2400			
	6TPE150MI								18	2800			
	6TPE100M	6.3	105	100	6.3	105	10.0	63.0	25	2400			
	6TPE100MI								18	2800			
	4TPE330M	4.0	105	330	4.0	105	10.0	132.0	25	2400			
	4TPE330MI								18	2800			
	4TPE220M	4.0	105	220	4.0	105	10.0	88.0	25	2400			
	4TPE220MI								18	2800			
	4TPE220MF								15	3100			
	4TPE150M	4.0	105	150	4.0	105	10.0	60.0	25	2400			
	4TPE150MI								18	2800			
	2R5TPE470M	2.5	105	470	2.5	105	10.0	117.5	25	2400			
	2R5TPE470MI								18	2800			
	2R5TPE470MF								15	3100			
	2R5TPE470MC								12	3500			
	2R5TPE470M9								9	3900			
	2R5TPE470M7	2.5	105	470	2.5	105	10.0	235.0	7	4400			(*2)
	2R5TPE330M	2.5	105	330	2.5	105	10.0	82.5	25	2400			
	2R5TPE330MI								18	2800			
	2R5TPE330MF								15	3100			
	2R5TPE330MC								12	3500			
	2R5TPE330M9								9	3900			
	2R5TPE330M7	2.5	105	330	2.5	105	10.0	165.0	7	4400			(*2)
2R5TPE220M	2.5	105	220	2.5	105	10.0	55.0	25	2400				
2R5TPE220MI								18	2800				
2R5TPE220MF								15	3100				
2R5TPE220MC								12	3500				
2R5TPE220M9								9	3900				
2R5TPE220M7	2.5	105	220	2.5	105	10.0	110.0	7	4400	(*2)			
D3L	10TPE220ML	10.0	105	220	10.0	105	10.0	220.0	25	2400	3		
	6TPE330ML	6.3	105	330	6.3	105	10.0	207.9	25	2400			
	6TPE330MIL								18	2800			
	4TPE470ML	4.0	105	470	4.0	105	10.0	188.0	25	2400			
	4TPE470MIL								18	2800			
	4TPE470MFL								15	3100			
	4TPE470MCL	2.5	105	680	2.5	105	10.0	170.0	12	3500			
	2R5TPE680ML								25	2400			
	2R5TPE680MIL								18	2800			
	2R5TPE680MFL								15	3100			
2R5TPE680MCL	12	3500											
D4	10TPE330M	10.0	105	330	10.0	105	10.0	330.0	25	3000	3		
	6TPE680M	6.3	105	680	6.3	105	15.0	428.4	25	3000			
	6TPE680MI								18	3500			
	6TPE470M	6.3	105	470	6.3	105	15.0	296.1	25	3000			
	6TPE470MI								18	3500			
	4TPE680M	4.0	105	680	4.0	105	15.0	272.0	25	3000			
	4TPE680MI								18	3500			
	4TPE680MF								15	3900			
	2R5TPE1000M	2.5	105	1000	2.5	105	15.0	250.0	25	3000			
	2R5TPE1000MI								18	3500			
	2R5TPE1000MF								15	3900			
	2R5TPE1000MFL								15	3900			
2R5TPE1500M	2.5	105	1500	2.5	105	15.0	375.0	15	3900				
2R5TPE1500MC								12	4400				

*1 100k to 500kHz, 45°C *2 Under evaluation

TPE Series Low ESR Products (C3,C2,B2 Size)

Feature

This products is the miniaturized version of TPE series.



Specifications

Items	Condition	Characteristics		
Operating Temperature range	—	-55 to +105 (°C)		
Rated capacitance range	120Hz/20°C	47 to 330 (μF)		
Capacitance tolerance	120Hz/20°C	M:±20%		
Rated voltage	—	2.5 to 10.0 (V.DC)		
Dissipation Factor (D.F.)	120Hz/20°C	≤ 8.0 (%)		
Leakage current	Rated voltage applied, after 5 minutes	Please see the attached characteristics list		
Equivalent series resistance (E.S.R. mΩmax.)	100kHz/20°C	Please see the attached characteristics list		
Temperature characteristics of Impedance ratio	100kHz/+20°C	-55°C	Z/Z _{20°C}	1.0 to 2.0
		+105°C	Z/Z _{20°C}	0.6 to 1.0
Endurance	105°C,2000h,(B2size:1000h) rated voltage applied *Rated temp. 85°C products: 85°C,1000h,rated voltage applied	ΔC/C	Within±20% of the initial value	
		D.F.	≤ 1.5 times the initial limit	
		L.C.	≤ The initial limit	
Damp heat (Steady state)	60°C,90 to 95%RH,500h, No voltage applied	ΔC/C	Within+50%, -20% of the initial value (2R5TPE220MAZB,2R5TPE330MAZB, 2TPE330MIB (MAFB,MAFGB),2R5TPE220MAPB,2R5TPE330MFC2 (CC2,9C2)) Within+40%, -20% of the initial value (Except for the above model)	
		D.F.	≤ 1.5 times the initial limit	
		L.C.	≤ 3 times the initial limit	
Surge	105°C,1000 times,1kΩdischarge resistance,surge voltage applied *Rated temp 85°C products: 85°C,1000 times	ΔC/C	Within±5% of the initial value	
		D.F.	≤ The initial limit	
		L.C.	≤ 3 times the initial limit	

Dimensions

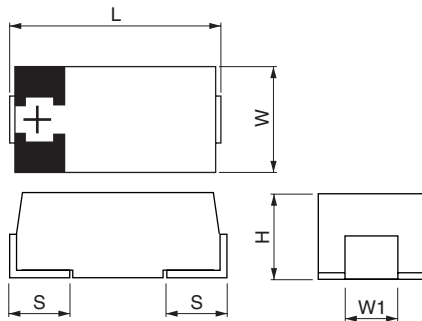

(unit: mm)

Size code	L (±0.2)	W (±0.2)	H*1 (±0.1)	S (±0.2)	W1 (±0.1)
B2	3.5	2.8	1.9	0.8	2.2
C2	6.0	3.2	1.8	1.3	1.8
C3	6.0	3.2	2.5	1.3	1.8

*1 ±0.2:C3

Size List

RV (SV)	2.0 (2.6)	2.5 (3.2)	4.0 (5.0)	6.3 (8.0)	8.0 (10.0)	10.0 (13.0)
47						B2
100			B2	B2	C2	
120				B2		
150		B2	B2	B2,C2,C3		C3
220		B2	B2,C2,C3	C3		
330	B2	B2,C2,C3				

Characteristics List

Size code	SANYO Part number	Rated Voltage (V)	Rated Temperature (°C)	Rated Capacitance (μF)	Category Voltage (V)	Category Temperature (°C)	D.F. (%max.)	L.C. (μA) max./5min.	E.S.R. (mΩmax.) 100kHz/20°C	Maximum allowable ripple current (mA)rms 100kHz*1	MSL	
											Reflow Temp ≤ 260°C	Reflow Temp ≤ 250°C
B2	10TPE47MAZB	10.0	85	47	8.0	105	8.0	47.0	35	1400	3	3
	6TPE150MAZB	6.3	85	150	5.0	105	8.0	94.5	35	1400		
	6TPE120MAZB	6.3	85	120	5.0	105	8.0	75.6	35	1400		
	6TPE100MZB*2	6.3	105	100	6.3	105	8.0	63.0	35	1400		
	6PTE100MPB*2								25	1600		
	6TPE100MAZB	6.3	85	100	5.0	105	8.0	63.0	35	1400		
	6PTE100MAPB*2	6.3	85	100	5.0	105	8.0	63.0	25	1600		
	4TPE220MAZB	4.0	85	220	3.2	105	8.0	88.0	35	1400		
	4TPE150MAZB	4.0	85	150	3.2	105	8.0	60.0	35	1400		
	4TPE150MAUB								30	1500		
	4TPE100MZB	4.0	105	100	4.0	105	8.0	40.0	35	1400		
	2R5TPE330MAZB	2.5	85	330	2.0	105	8.0	82.5	35	1400		
	2R5TPE220MZB	2.5	105	220	2.5	105	8.0	55.0	35	1400		
	2R5TPE220MPB								25	1600		
	2R5TPE220MLB								21	1700		
	2R5TPE220MIB	2.5	105	220	2.5	105	8.0	110.0	18	1800		
	2R5TPE220MFB								15/300k	1800		
	2R5TPE220MAFB*2	2.5	85	220	2.0	105	8.0	110.0	15	2000		
	2R5TPE220MAZB	2.5	85	220	2.0	105	8.0	55.0	35	1400		
	2R5TPE220MAPB								25	1600		
2R5TPE150MZB	2.5	105	150	2.5	105	8.0	37.5	35	1400			
2TPE330MIB	2.0	105	330	2.0	105	8.0	132.0	18	1800			
2TPE330MAFGB	2.0	85	330	1.6	105	8.0	132.0	15/300k	1800			
2TPE330MAFB*2								15	2000			
C2	8TPE100MPC2	8.0	105	100	8.0	105	8.0	80.0	25	2200	3	3
	6TPE150MPC2	6.3	105	150	6.3	105	8.0	94.5	25	2200		
	6TPE150MIC2								18	2600		
	4TPE220MIC2	4.0	105	220	4.0	105	8.0	88.0	18	2600		
	4TPE220MFC2								15	2900		
	2R5TPE330MFC2	2.5	105	330	2.5	105	8.0	82.5	15	2900		
	2R5TPE330MCC2								12	3300		
	2R5TPE330M9C2								9	3700		
C3	10TPE150MGC	10.0	105	150	10.0	105	10.0	150.0	55	1500	(*3)	3
	6TPE220MPC	6.3	105	220	6.3	105	8.0	138.6	25	2400		
	6TPE150MPC	6.3	105	150	6.3	105	8.0	94.5	25	2400		
	4TPE220MPC	4.0	105	220	4.0	105	8.0	88.0	25	2400		
	4TPE220MIC								18	2800		
	2R5TPE330MPC	2.5	105	330	2.5	105	8.0	82.5	25	2400		
	2R5TPE330MIC								18	2800		
	2R5TPE330MFC								15	3100		

*1 100k to 500kHz, 45°C *2 Under development *3 Under evaluation

TPF Series Low ESR · High Capacitance Products

Feature

TPF series has low ESR and high capacitance at standard form.

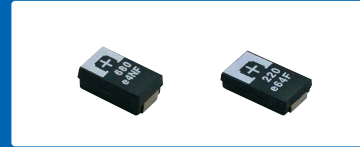

Specifications

Items	Condition	Characteristics		
Operating Temperature range	—	-55 to +105 (°C)		
Rated capacitance range	120Hz/20°C	150 to 680 (μF)		
Capacitance tolerance	120Hz/20°C	M:±20%		
Rated voltage	—	2.0 to 10.0 (V.DC)		
Dissipation Factor (D.F.)	120Hz/20°C	10.0 (%)		
Leakage current	Rated voltage applied, after 5 minutes	Please see the attached characteristics list		
Equivalent series resistance (E.S.R. mΩmax.)	100kHz/20°C	Please see the attached characteristics list		
Temperature characteristics of Impedance ratio	100kHz/+20°C	-55°C	Z/Z _{20°C}	1.0 to 2.0
		+105°C	Z/Z _{20°C}	0.6 to 1.0
Endurance	105°C, 2000h, rated voltage applied	ΔC/C	Within±20% of the initial value	
		D.F.	≤ 1.5 times the initial limit	
		L.C.	≤ The initial limit	
Damp heat (Steady state)	60°C, 90 to 95%RH, 500h, No voltage applied	ΔC/C	Within+50%, -20% of the initial value (D2E size) Within+40%, -20% of the initial value (Except for the above model)	
		D.F.	≤ 1.5 times the initial limit	
		L.C.	≤ 3 times the initial limit	
Surge	105°C, 1000 cycles, 1kΩ discharge resistance, surge voltage applied	ΔC/C	Within±5% of the initial value	
		D.F.	≤ The initial limit	
		L.C.	≤ 3 times the initial limit	

Dimensions

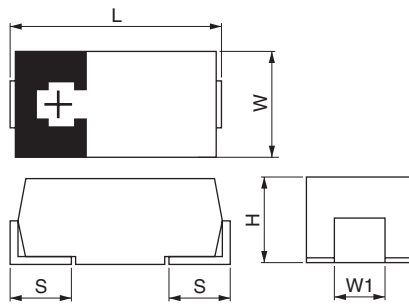

(unit: mm)

Size code	L (±0.3)	W (±0.2)	H*1 (±0.1)	S (±0.1)	W1 (±0.1)
D3L	7.3	4.3	2.8	1.3	2.4
D2E	7.3	4.3	1.8	1.3	2.4

Size List

*1 ±0.1; D2E

μF	RV (SV)	2.0 (2.6)	2.5 (3.2)	4.0 (5.0)	6.3 (8.0)	10.0 (13.0)
150						D3L
220		D2E			D3L	
330		D2E	D3L	D3L	D3L	
470		D2E	D3L	D3L		
680			D3L			

Characteristics List

Size code	SANYO Part number	Rated Voltage (V)	Rated Temperature (°C)	Rated Capacitance (μF)	Category Voltage (V)	Category Temperature (°C)	D.F. (%max.)	L.C. (μA) max./5min.	E.S.R. (mΩmax.) 100kHz/20°C	Maximum allowable ripple current (mA _{rms}) 100kHz ^{*1}	MSL	
											Reflow Temp. ≤ 260°C	Reflow Temp. ≤ 250°C
D3L	10TPF150ML	10.0	105	150	10.0	105	10.0	150.0	15	3600	3	2a
	6TPF330M9L	6.3	105	330	6.3	105	10.0	207.9	9	3900		
	6TPF220ML	6.3	105	220	6.3	105	10.0	138.6	12	4000		
	4TPF470ML	4.0	105	470	4.0	105	10.0	188.0	10	4400		
	4TPF330ML	4.0	105	330	4.0	105	10.0	132.0	12	4000		
	2R5TPF680ML	2.5	105	680	2.5	105	10.0	170.0	10	4400		
	2R5TPF680M7L	2.5	105	680	2.5	105	10.0	170.0	7	4400		
	2R5TPF680M6L	2.5	105	680	2.5	105	10.0	170.0	6	4400		
	2R5TPF470ML	2.5	105	470	2.5	105	10.0	117.5	10	4400		
	2R5TPF470M7L	2.5	105	470	2.5	105	10.0	117.5	7	4400		
D2E	2TPF470M6	2.0	105	470	2.0	105	10.0	188.0	6	4400	(*2)	
	2TPF330M6	2.0	105	330	2.0	105	10.0	132.0	6	4400		
	2TPF220M6	2.0	105	220	2.0	105	10.0	188.0	6	4400		

*1 100k to 500kHz, 45°C *2 Under evaluation

TPG Series Small Size · High Capacitance Products

Feature

TPG series is high capacitance model of the small size · low profile product. Suitable for the miniaturization design of the electronics device.



Specifications

Items	Condition	Characteristics		
Operating Temperature range	—	-55 to +105 (°C)		
Rated capacitance range	120Hz/20°C	30 to 220 (μF)		
Capacitance tolerance	120Hz/20°C	M:±20%		
Rated voltage	—	2.5 to 12.5 (V.DC)		
Dissipation Factor (D.F.)	120Hz/20°C	≤ 10.0 (%)		
Leakage current	Rated voltage applied, after 5 minutes	Please see the attached characteristics list		
Equivalent series resistance (E.S.R. mΩmax.)	100kHz/20°C	Please see the attached characteristics list		
Temperature characteristics of Impedance ratio	100kHz/+20°C	-55°C	Z/Z _{20°C}	1.0 to 2.0
		+105°C	Z/Z _{20°C}	0.6 to 1.0
Endurance	85°C,1000h, rated voltage applied or 105°C,1000h, category voltage applied	ΔC/C	Within±20% of the initial value	
		D.F.	≤ 1.5 times the initial limit	
		L.C.	≤ The initial limit	
Damp heat (Steady state)	60°C,90 to 95%RH,500h, No voltage applied	ΔC/C	Within+40%, -20% of the initial value	
		D.F.	≤ 1.5 times the initial limit	
		L.C.	≤ 3 times the initial limit	
Surge	85°C,1000 cycles, 1kΩdischarge resistance, surge voltage applied	ΔC/C	Within±5% of the initial value	
		D.F.	≤ The initial limit	
		L.C.	≤ 3 times the initial limit	

(unit: mm)

Dimensions

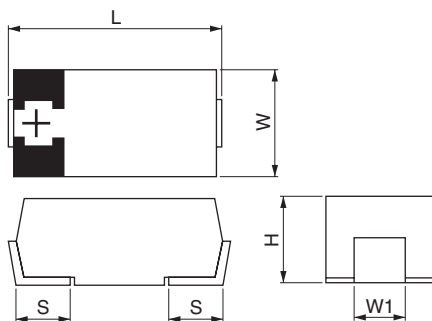

Size code	L (+0.3/-0.1)	W (+0.3/-0.1)	H (±0.1)	S (±0.2)	W1 (±0.1)
B1G	3.5	2.8	1.1	0.8	2.2
B15G	3.5	2.8	1.4	0.8	2.2

Size List

μF	RV (SV)	2.5 (3.2)	4.0 (5.0)	6.3 (8.0)	8.0 (10.0)	10.0 (13.0)	12.5 (16.0)
33						B1G	B1G
47					B1G	B1G	
68				B1G			
100				B1G			
150			B1G	B15G			
220	B1G	B15G					

Characteristics List

Size code	SANYO Part number	Rated Voltage (V)	Rated Temperature (°C)	Rated Capacitance (μF)	Category Voltage (V)	Category Temperature (°C)	D.F. (%max.)	L.C. (μA) max./5min.	E.S.R. (mΩmax.) 100kHz/20°C	Maximum allowable ripple current (mArms) 100kHz*1	MSL	
											Reflow Temp. ≤ 260°C	Reflow Temp. ≤ 250°C
B15G	6TPG150M	6.3	85	150	5.0	105	10.0	94.5	70	1000	3	3
	4TPG220M	4.0	85	220	3.2	105	10.0	88.0	70	1000		
B1G	12TPG33M	12.5	85	33	10.0	105	10.0	41.3	70	1000		
	10TPG47M	10.0	85	47	8.0	105	10.0	47.0	70	1000		
	10TPG33M	10.0	85	33	8.0	105	10.0	33.0	70	1000		
	8TPG47M	8.0	85	47	6.4	105	10.0	37.6	70	1000		
	6TPG100M	6.3	85	100	5.0	105	10.0	63.0	70	1000		
	6TPG68M	6.3	85	68	5.0	105	10.0	42.8	70	1000		
	4TPG150M	4.0	85	150	3.2	105	10.0	60.0	70	1000		
	2R5TPG220M	2.5	85	220	2.0	105	10.0	55.0	70	1000		

*1 100k to 500kHz,45°C

TPL/TPLF Series Low ESR · Low ESL Products Face Down Terminal Type

Feature

TPL series has a low ESL and low ESR advantage using an unique face down terminal structure.



Specifications

Items	Condition	Characteristics		
Operating Temperature range	—	-55 to +105 (°C)		
Rated capacitance range	120Hz/20°C	220 to 470 (μF)		
Capacitance tolerance	120Hz/20°C	M:±20%		
Rated voltage	—	2.0 to 2.5 (V.DC)		
Dissipation Factor (D.F.)	120Hz/20°C	≤ 10.0 (%)		
Leakage current	Rated voltage applied, after 5 minutes	Please see the attached characteristics list		
Equivalent series resistance (E.S.R. mΩmax.)	100kHz/20°C	Please see the attached characteristics list		
Temperature characteristics of Impedance ratio	100kHz/+20°C	-55°C	Z/Z _{20°C}	1.0 to 2.0
		+105°C	Z/Z _{20°C}	0.6 to 1.0
Endurance	105°C, 2000h, rated voltage applied	ΔC/C	Within±20% of the initial value	
		D.F.	≤ 1.5 times the initial limit	
		L.C.	≤ The initial limit	
Damp heat (Steady state)	60°C, 90 to 95%RH, 500h, No voltage applied	ΔC/C	Within+50%, -20% of the initial value	
		D.F.	≤ 1.5 times the initial limit	
		L.C.	≤ 3 times the initial limit	
Surge	105°C, 1000 times, 1kΩ discharge resistance, Surge voltage applied	ΔC/C	Within±5% of the initial value	
		D.F.	≤ The initial limit	
		L.C.	≤ 3 times the initial limit	

Dimensions

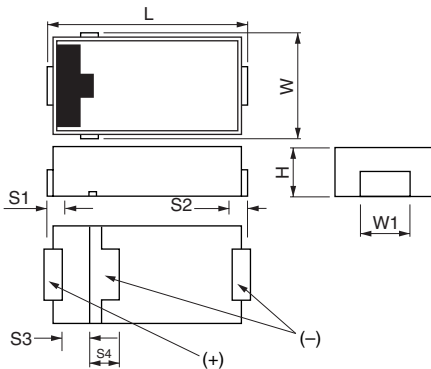

Size List

RV (SV)	2.0 (2.6)	2.5 (3.2)
220	D2T	D2T
330	D2T	D2T
470	D2T	D2T

(unit: mm)

Size code	L (±0.3)	W (±0.2)	H (±0.1)	S1/S2 (±0.2)	S3 (±0.1)	S4 (±0.2)	W1 (±0.1)
D2T	7.3	4.3	1.8	1.1	1.1	2.3	2.8

Characteristics List

(TPL)

Size code	SANYO Part number	Rated Voltage (V)	Rated Temperature (°C)	Rated Capacitance (μF)	Category Voltage (V)	Category Temperature (°C)	D.F. (%max.)	L.C. (μA) max./5min.	E.S.R. (mΩmax.) 100kHz/20°C	Maximum allowable ripple current (mA _{RMS})*1 100kHz	MSL	
											Reflow Temp. ≤ 260°C	Reflow Temp. ≤ 250°C
D2T	2R5TPL470MC	2.5	105	470	2.5	105	10.0	117.5	12	3400	3	2a
	2R5TPL470M9								9	3900		
	2R5TPL470M8							235.0	8	4100		
	2R5TPL470M7*2								7	4400		
	2R5TPL330MC	2.5	105	330	2.5	105	10.0	82.5	12	3400		
	2R5TPL330M9								9	3900		
	2R5TPL330M8							165.0	8	4100		
	2R5TPL330M7*2								7	4400		
	2R5TPL220MC	2.5	105	220	2.5	105	10.0	55.0	12	3400		

*1 100k to 500kHz,45°C *2 Under development

(TPLF)

Size code	SANYO Part number	Rated Voltage (V)	Rated Temperature (°C)	Rated Capacitance (μF)	Category Voltage (V)	Category Temperature (°C)	D.F. (%max.)	L.C. (μA) max./5min.	E.S.R. (mΩmax.) 100kHz/20°C	Maximum allowable ripple current (mA _{RMS})*1 100kHz	MSL	
											Reflow Temp. ≤ 260°C	Reflow Temp. ≤ 250°C
D2T	2TPLF470M7	2.0	105	470	2.0	105	10.0	188.0	7	4400	3	2a
	2TPLF470M6								6	4700		
	2TPLF330M7			330				132.0	7	4400		
	2TPLF330M6								6	4700		
	2TPLF220M7			220				88.0	7	4400		
	2TPLF220M6								6	4700		

*1 100k to 500kHz,45°C

TPU Series Small Size · Low Profile Products Face Down Terminal Type

Feature

TPU series has a real advantage in size-sensitive applications using a face down terminal structure.

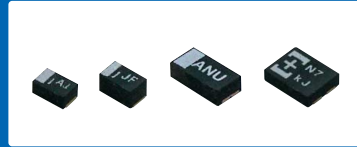

Specifications

Items	Condition	Characteristics		
Operating Temperature range	—	-55 to +85 (°C)		
Rated capacitance range	120Hz/20°C	10 to 100 (μF)		
Capacitance tolerance	120Hz/20°C	M:±20%		
Rated voltage	—	2.5 to 10.0 (V.DC)		
Dissipation Factor (D.F.)	120Hz/20°C	≤ 10.0 (%)		
Leakage current	Rated voltage applied, after 5 minutes	Please see the attached characteristics list		
Equivalent series resistance (E.S.R. mΩmax.)	100kHz/20°C	Please see the attached characteristics list		
Temperature characteristics of Impedance ratio	100kHz/+20°C	-55°C	Z/Z _{20°C}	1.0 to 2.0
		+85°C	Z/Z _{20°C}	0.6 to 1.0
Endurance	85°C, 1000h, rated voltage applied	ΔC/C	Within±20% of the initial value	
		D.F.	≤ 1.5 times the initial limit	
		L.C.	≤ The initial limit	
Damp heat (Steady state)	60°C, 90 to 95%RH, 500h, No voltage applied	ΔC/C	Within+40%, -20% of the initial value	
		D.F.	≤ 1.5 times the initial limit	
		L.C.	≤ 3 times the initial limit	
Surge	85°C, 1000 times, 1kΩ discharge resistance, Surge voltage applied	ΔC/C	Within±5% of the initial value	
		D.F.	≤ The initial limit	
		L.C.	≤ 3 times the initial limit	

Dimensions

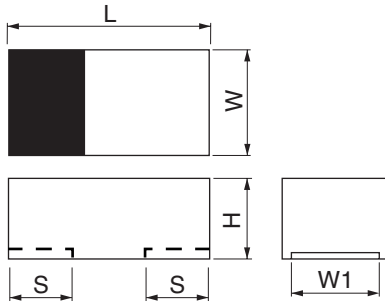

(unit: mm)

Size code	L (±0.1)*1	W (±0.1)*1	H (±0.1)	S (±0.1)*1	W1 (±0.1)
S08	2.0	1.25	0.8	0.5	0.9
S11	2.0	1.25	1.1	0.5	0.9
A09	3.2	1.6	0.9	0.8	1.2
B09	3.5	2.8	0.9	0.8	2.2

*1 ±0.2: A09, B09

Size List

RV (sV)	2.5 (3.2)	3.15 (4.0)	4.0 (5.0)	6.3 (8.0)	8.0 (10.0)	10.0 (13.0)
10				S08		
15			S08			
22	S08			S11		
33			S11		B09	A09
47	S11			A09, B09		
68			A09, B09			
100	A09	A09				

Characteristics List

Size code	SANYO Part number	Rated Voltage (V)	Rated Temperature (°C)	Rated Capacitance (μF)	Category Voltage (V)	Category Temperature (°C)	D.F. (%max.)	L.C. (μA) max./5min.	E.S.R. (mΩmax.) 100kHz/20°C	Maximum allowable ripple current (mA) 100kHz*1	MSL	
											Reflow Temp. ≤ 260°C	Reflow Temp. ≤ 250°C
S08	6TPU10M	6.3	85	10	6.3	85	10.0	6.3	250	400	Under evaluation	3
	4TPU15M	4.0	85	15	4.0	85	10.0	6.0	250	400		
	2R5TPU22M	2.5	85	22	2.5	85	10.0	5.5	250	400		
S11	6TPU22MSK	6.3	85	22	6.3	85	10.0	13.9	150	510		
	4TPU33MSK	4.0	85	33	4.0	85	10.0	13.2	150	510		
	2R5TPU47MSK	2.5	85	47	2.5	85	10.0	11.8	150	510		
A09	10TPU33MAI	10.0	85	33	10.0	85	10.0	33.0	150	510		
	6TPU47MAI	6.3	85	47	6.3	85	10.0	29.6	150	510		
	4TPU68MAI	4.0	85	68	4.0	85	10.0	27.2	150	510		
	3TPU100MAI	3.15	85	100	3.15	85	10.0	31.5	150	510		
B09	2R5TPU100MAI	2.5	85	100	2.5	85	10.0	25.0	150	510		
	8TPU33MBI	8.0	85	33	8.0	85	10.0	26.4	70	800		
	6TPU47MBI	6.3	85	47	6.3	85	10.0	29.6	70	800		
	4TPU68MBI	4.0	85	68	4.0	85	10.0	27.2	70	800		

*1 100k to 500kHz, 45°C

TA Series High Reliability Products (For The Car Electronics)

Feature

TA series are high reliability products that the heat resistance and moisture resistance are improved.

*Suitable for the industrial equipment or car electronics (e.g. Car navigation system).

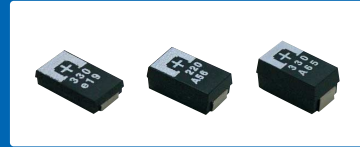

Specifications

Items	Condition	Characteristics	
Operating Temperature range	—	-55 to +105 (°C)	
Rated capacitance range	120Hz/20°C	47 to 680 (μF)	
Capacitance tolerance	120Hz/20°C	M:±20%	
Rated voltage	—	2.5 to 10 (V.DC)	
Dissipation Factor (D.F.)	120Hz/20°C	10.0 (%)	
Leakage current	Rated voltage applied, after 5 minutes	Please see the attached characteristics list	
Equivalent series resistance (E.S.R. mΩmax.)	100kHz/20°C	Please see the attached characteristics list	
Temperature characteristics of Impedance ratio	100kHz/+20°C	-55°C Z/Z _{20°C}	1.0 to 2.0
		+105°C Z/Z _{20°C}	0.6 to 1.0
Endurance	105°C, 2000h, rated voltage applied	ΔC/C	Within±20% of the initial value
		D.F.	≤ 1.5 times the initial limit
		L.C.	≤ The initial limit
Damp heat (Load)	85°C, 85%RH, 500h, rated voltage applied	ΔC/C	Within+40%, -20% of the initial value *1
		D.F.	≤ 1.5 times the initial limit
		L.C.	≤ The initial limit
Damp heat (Steady state)	60°C, 90 to 95%RH, 500h, No voltage applied	ΔC/C	Within+40%, -20% of the initial value *1
		D.F.	≤ 1.5 times the initial limit
		L.C.	≤ 3 times the initial limit
Surge	105°C, 1000 cycles, 1kΩdischarge resistance, surge voltage applied	ΔC/C	Within±5% of the initial value
		D.F.	≤ The initial limit
		L.C.	≤ 3 times the initial limit

Dimensions

*1 Within +50%, -20% of the initial value(2R5TAE470M(F,C), 2R5TAE330M(F,C), 2R5TAE220M(F,C)) (unit: mm)

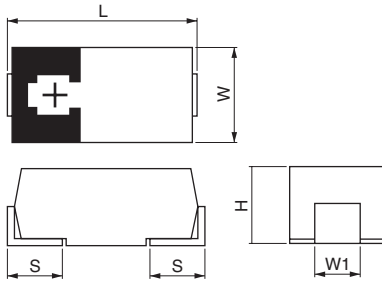

Size code	L*2 (±0.3)	W (±0.2)	H*1 (±0.2)	S (±0.2)	W1 (±0.1)
B2	3.5	2.8	1.9	0.8	2.2
D2E	7.3	4.3	1.8	1.3	2.4
D3L	7.3	4.3	2.8	1.3	2.4

*1 ±0.1:D2E,B2 *2 ±0.2:B2

Size List

μF	RV (SV)	2.5	4	6.3	10
47				B2	B2
68				B2	D2E
100			B2		
150				D2E	
220		D2E	D2E	D2E	D3L
330		D2E		D3L	
470		D2E	D3L		
680		D3L			

Characteristics List

Size code	SANYO Part number	Rated Voltage (V)	Rated Temperature (°C)	Rated Capacitance (μF)	Category Voltage (V)	Category Temperature (°C)	D.F. (%max.)	L.C. (μA) max./5min.	E.S.R. (mΩmax.) 100kHz/20°C	Maximum allowable ripple current (mArms) 100kHz*1	MSL	
											Reflow Temp. ≤ 260°C	Reflow Temp. ≤ 250°C
B2	10TAB47M	10.0	105	47	10.0	105	8.0	47.0	70	1100	3	3
	6TAB68M	6.3	105	68	6.3	105	8.0	42.8	70	1100		
	6TAB47M	6.3	105	47	6.3	105	8.0	29.6	70	1100		
	4TAB100M	4.0	105	100	4.0	105	8.0	40.0	70	1100		
D2E	10TAE68M	10.0	105	68	10.0	105	10.0	68	25	2400		
	6TAE220M	6.3	105	220	6.3	105	10.0	138.6	25	2400		
	6TAE220MI								18	2800		
	6TAE150M	6.3	105	150	6.3	105	10.0	94.5	25	2400		
	4TAE220M	4.0	105	220	4.0	105	10.0	88	25	2400		
	4TAE220MI								18	2800		
	2R5TAE470M	2.5	105	470	2.5	105	10.0	117.5	25	2400		
	2R5TAE470MF								15	3100		
	2R5TAE470MC								12	3500		
	2R5TAE330M								25	2400		
	2R5TAE330MI	2.5	105	330	2.5	105	10.0	82.5	18	2800		
	2R5TAE330MF								15	3100		
2R5TAE330MC	12								3500			
2R5TAE220M	25								2400			
2R5TAE220MF	2.5	105	220	2.5	105	10.0	55	15	3100			
2R5TAE220MFL								15	3100			
D3L	10TAE220ML	10.0	105	220	10.0	105	10.0	220.0	25	2400		
	6TAE330ML	6.3	105	330	6.3	105	10.0	207.9	25	2400		
	4TAE470ML	4.0	105	470	4.0	105	10.0	188	25	2400		
	4TAE470MIL								18	2800		
	2R5TAE680ML	2.5	105	680	2.5	105	10.0	170	25	2400		
	2R5TAE680MFL								15	3100		

*1 100k to 500kHz, 45°C

TH Series 125°C Guaranteed Products (THB/THC/THD/THE series)

Feature

TH series has 125°C capability guaranteed. It is the most suitable for the high reliability industrial equipment.



Specifications

Items	Condition	Characteristics			
		THB	THC	THD	THE
Series	—	THB	THC	THD	THE
Operating Temperature range	—	-55 to +125 (°C)			
Rated capacitance range	120Hz/20°C	100 to 1000 (μF)	68 to 220 (μF)	330 to 680 (μF)	150 to 330 (μF)
Capacitance tolerance	120Hz/20°C	M: ±20%			
Rated voltage	—	2.5 to 10 (V.DC)	2.5 to 10 (V.DC)	2.5 to 6.3 (V.DC)	2.5 to 6.3 (V.DC)
Dissipation Factor (D.F.)	120Hz/20°C	≤ 8.0 or 10.0 or 15.0 (%)	≤ 10.0 (%)	≤ 10.0 (%)	≤ 10.0 (%)
Leakage current	Rated voltage applied, after 5 minutes	Please see the attached characteristic list			
Equivalent series resistance (E.S.R. mΩmax.)	100kHz/20°C	Please see the attached characteristic list			
Temperature characteristics of Impedance ratio	100kHz/20°C	-55°C	Z/Z _{20°C}	1.0 to 2.0	
		+125°C	Z/Z _{20°C}	0.6 to 1.0	
Endurance	125°C, 1000h, category voltage applied	ΔC/C	Within ±20% of the initial value		
		tan δ	≤ 2 times the initial limit		
		L.C.	≤ 2 times the initial limit		
Damp heat (Steady state)	60°C, 90 to 95%RH, 500h, No voltage applied	ΔC/C	Within +50%, -20% of the initial value (2R5THB1000M) Within +40%, -20% of the initial value (Except for the above model)		
		tan δ	≤ 1.5 times the initial limit		
		L.C.	≤ 3 times the initial limit		
Surge	105°C, 1000 cycles, 1kΩ discharge resistance, surge voltage applied	ΔC/C	Within ±5% of the initial value		
		tan δ	≤ The initial limit		
		L.C.	≤ 3 times the initial limit		

Dimensions

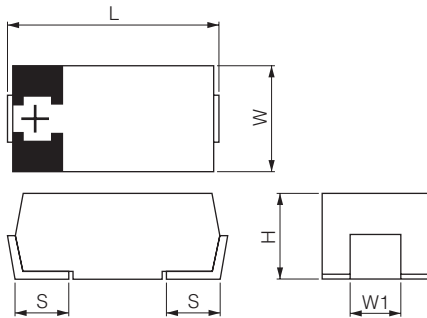

(unit: mm)

Size code	L*1 (±0.3)	W (±0.2)	H*2 (±0.1)	S (±0.2)	W1 (±0.1)
D2E	7.3	4.3	1.8	1.3	2.4
D2	7.3	4.3	1.9	1.3	2.4
D3L	7.3	4.3	2.8	1.3	2.4
D4	7.3	4.3	3.8	1.3	2.4
D4D	7.3	4.3	3.6	1.3	2.4

*1 ±0.2: D2 *2 ±0.2: D3L, D4, D4D

Size List

μF	Series	RV (SV)	2.5 (3.2)	4.0 (5.0)	6.3 (8.0)	10.0 (13.0)
68	THC					D2
100	THB					D3L
150	THC				D2	
	THE				D2E	
220	THB				D3L	D4
	THC	D2	D2			
	THE		D2E			
330	THB	D3L	D3L	D4	D4	
	THD				D4D	
	THE	D2E				
470	THB	D3L		D4		
	THD			D4D		
680	THB	D4	D4			
	THD	D4D				
1000	THB	D4				

Characteristics List

Series	Size code	SANYO Part number	Rated Voltage (V)	Rated Temperature (°C)	Rated Capacitance (μF)	Category Voltage (V)	Category Temperature (°C)	D.F. (%max.)	L.C. (μA) max./5min.	E.S.R. (mΩmax.) 100kHz/20°C	Maximum allowable ripple current (mA rms) 100kHz*1	MSL			
												Reflow Temp. ≤ 260°C	Reflow Temp. ≤ 250°C		
THB	D3L	10THB100ML	10.0	105	100	6.3	125	8.0	100.0	55	1900	Under evaluation	5		
		6THB220ML	6.3	105	220	4.0	125	10.0	138.6	40	2000				
		4THB330ML	4.0	105	330	2.5	125	10.0	132.0	40	2000				
		2R5THB470ML	2.5	105	470	1.6	125	10.0	117.5	40	2000				
		2R5THB330ML	2.5	105	330	1.6	125	10.0	82.5	55	1900				
	D4	10THB330M	10.0	105	330	6.3	125	10.0	330.0	35	3000				
		10THB220M	10.0	105	220	6.3	125	10.0	220.0	40	3000				
		6THB470M	6.3	105	470	4.0	125	15.0	296.1	35	3000				
		6THB330M	6.3	105	330	4.0	125	10.0	207.9	40	3000				
		4THB680M	4.0	105	680	2.5	125	15.0	272.0	35	3000				
		2R5THB1000M	2.5	105	1000	1.6	125	15.0	250.0	30	3000				
		2R5THB680M	2.5	105	680	1.6	125	10.0	170.0	40	3000				
		THC	D2	10THC68M	10.0	105	68	6.3	125	10.0	68.0			45	1700
				6THC150M	6.3	105	150	4.0	125	10.0	94.5			40	1900
4THC220M	4.0			105	220	2.5	125	10.0	88.0	40	1900				
2R5THC220M	2.5			105	220	1.6	125	10.0	55.0	45	1700				
THE	D2E	6THE150M	6.3	105	150	4.0	125	10.0	94.5	25	2400				
		6THE150MI								18	2800				
		4THE220M	4.0	105	220	2.5	125	10.0	88.0	25	2400				
		4THE220MI								18	2800				
		4THE220MF								15	3100				
		2R5THE330M	2.5	105	330	1.6	125	10.0	82.5	25	2400				
		2R5THE330MI								18	2800				
		2R5THE330MF								15	3100				
THD	D4	6THD330M	6.3	105	330	4.0	125	10.0	207.9	10	4400				
		4THD470M	4.0	105	470	2.5	125	10.0	188.0	10	4400				
		2R5THD680M	2.5	105	680	1.6	125	10.0	170.0	10	4400				

*1 100k to 500kHz, 45°C

TR Series High Moisture Resistance Products

Feature

TR series are improved model of the moisture resistance more than standard products. Suitable for the industrial equipment.



Specifications

Items	Condition	Characteristics		
Operating Temperature range	—	-55 to +105 (°C)		
Rated capacitance range	120Hz/20°C	33 to 680 (μF)		
Capacitance tolerance	120Hz/20°C	M:±20%		
Rated voltage	—	2.5 to 10 (V.DC)		
Dissipation Factor (D.F.)	120Hz/20°C	10.0 (%) ,B2size:≤ 8.0 (%) D4size:≤ 15.0 (%)		
Leakage current	Rated voltage applied, after 5 minutes	Please see the attached characteristics list		
Equivalent series resistance (E.S.R. mΩmax.)	100kHz/20°C	Please see the attached characteristics list		
Temperature characteristics of Impedance ratio	100kHz/+20°C	-55°C	Z/Z _{20°C}	1.0 to 2.0
		+105°C	Z/Z _{20°C}	0.6 to 1.0
Endurance	105°C,2000h,(B2size:1000h) rated voltage applied *Rated temp. 85°C products: 85°C,1000h,rated voltage applied	ΔC/C	Within±20% of the initial value	
		D.F.	≤ 1.5 times the initial limit	
		L.C.	≤ The initial limit	
Damp heat (Load)	85°C, 85%RH, 500h, rated voltage applied	ΔC/C	Within+50%, -20% of the initial value (2R5TRE220MAZB, 2R5TRE470M (F.C), 2R5TRE330M (F.C), 2R5TRE220M (F.C)) Within+40%, -20% of the initial value (Except for the above model)	
		D.F.	≤ 1.5 times the initial limit	
		L.C.	≤ The initial limit	
Damp heat (Steady state)	60°C,90 to 95%RH,500h, No voltage applied	ΔC/C	Within+50%, -20% of the initial value (2R5TRE220MAZB, 2R5TRE470M (F.C), 2R5TRE330M (F.C), 2R5TRE220M (F.C)) Within+40%, -20% of the initial value (Except for the above model)	
		D.F.	≤ 1.5 times the initial limit	
		L.C.	≤ 3 times the initial limit	
Surge	105°C,1000 times,1kΩdischarge resistance,surge voltage applied *Rated temp. 85°C products:85°C	ΔC/C	Within±5% of the initial value	
		D.F.	≤ The initial limit	
		L.C.	≤ 3 times the initial limit	

Dimensions

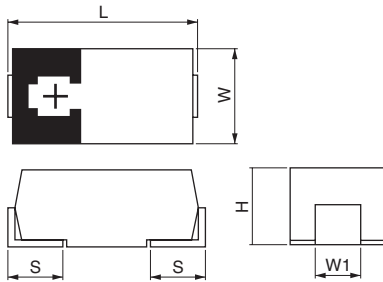

(unit: mm)

Size code	L*1 (±0.3)	W (±0.2)	H*2 (±0.2)	S (±0.2)	W1 (±0.1)
B2	3.5	2.8	1.9	0.8	2.2
D2E	7.3	4.3	1.8	1.3	2.4
D3L	7.3	4.3	2.8	1.3	2.4

*1 ±0.2:B2 *2 ±0.1:D2E,B2

Size List

RV (SV)	2.5	4	6.3	10
33				B2
47			B2	
68		B2		D2E
100			B2	
150		B2	B15G,D2E	
220	B2,D2E	D2E	D2E	
330	D2E	D3L	D3L	
470	D2E	D3L		
680	D3L			

Characteristics List

Size code	SANYO Part number	Rated Voltage (V)	Rated Temperature (°C)	Rated Capacitance (μF)	Category Voltage (V)	Category Temperature (°C)	D.F. (%max.)	L.C. (μA) max./5min.	E.S.R. (mΩmax.) 100kHz/20°C	Maximum allowable ripple current (mA rms) 100kHz*1	MSL	
											Reflow Temp. ≤ 260°C	Reflow Temp. ≤ 250°C
B15G	6TRG150M	6.3	85	150	5.0	105	10.0	94.5	70	1000	3	
B2	10TRB33M	10.0	105	33	10.0	105	8.0	33.0	70	1100		
	6TRE100MAZB	6.3	85	100	5.0	105	8.0	63.0	35	1400		
	6TRB47M	6.3	105	47	6.3	105	8.0	29.6	70	1100		
	4TRE150MAZB	4.0	85	150	3.2	105	8.0	60.0	35	1400		
	4TRB68M	4.0	105	68	4.0	105	8.0	27.2	70	1100		
	2R5TRE220MAZB	2.5	85	220	2.0	105	8.0	55.0	35	1400		
D2E	10TRE68M	10.0	105	68	10.0	105	10.0	68	25	2400	3	2a
	6TRE220M	6.3	105	220	6.3	105	10.0	138.6	25	2400		
	6TRE220MI								18	2800		
	6TRE150M	6.3	105	150	6.3	105	10.0	94.5	25	2400		
	4TRE220M	4.0	105	220	4.0	105	10.0	88	25	2400		
	4TRE220MI								18	2800		
	2R5TRE470M	2.5	105	470	2.5	105	10.0	117.5	25	2400		
	2R5TRE470MF								15	3100		
	2R5TRE470MC								12	3500		
	2R5TRE330M	2.5	105	330	2.5	105	10.0	82.5	25	2400		
	2R5TRE330MF								15	3100		
	2R5TRE330MC								12	3500		
	2R5TRE220M	2.5	105	220	2.5	105	10.0	55	25	2400		
	2R5TRE220MF								15	3100		
	2R5TRE220MC								12	3500		
D3L	6TRE330ML	6.3	105	330	6.3	105	10.0	207.9	25	2400		
	4TRE470ML	4.0	105	470	4.0	105	10.0	188	25	2400		
	4TRE470MIL								18	2800		
	4TRE330ML	4.0	105	330	4.0	105	10.0	132	25	2400		
	2R5TRE680ML	2.5	105	680	2.5	105	10.0	170	25	2400		
	2R5TRE680MFL								15	3100		

*1 100k to 500kHz, 45°C

TQC Series High Voltage Products

Feature

TQC series is perfect for high voltage, low ESR and low profile applications. It is the most suitable for pass-con of the motor driver by 12V, the input of the DCDC converter.

Peak temperature 250°C lead free reflow soldering products. (See P17)

★Please contact us, if your reflow condition exceeds this condition.



Specifications

Items	Condition	Characteristics	
Operating Temperature range	—	-55 to +105 (°C)	
Rated capacitance range	120Hz/20°C	5.6 to 68 (μF)	
Capacitance tolerance	120Hz/20°C	M:±20%	
Rated voltage	—	16 to 25 (V.DC)	
Dissipation Factor (D.F.)	120Hz/20°C	≤ 10.0 (%)	
Leakage current (μA)	Rated voltage applied, after 5 minutes	≤ 0.1CV ★B2size: ≤ 0.3CV	
Equivalent series resistance (E.S.R. mΩmax.)	100kHz/20°C	Please see the attached characteristics list	
Temperature characteristics of Impedance ratio	100kHz/+20°C	-55°C Z/Z20°C	1.0 to 2.0
		+105°C Z/Z20°C	0.6 to 1.0
Endurance	105°C, 2000h →25TQC15M, 25TQC22M (category voltage applied), 20TQC22M, 16TQC33M, 16TQC47M (rated voltage applied) 105°C, 1000h →25TQC5R6M, 25TQC33M, 25TQC22MV, 25TQC15MV, 25TQC10M (category voltage applied), 20TQC8R2M, 20TQC47M, 16TQC10M, 16TQC68M, 20TQC15M, 16TQC22M, 20TQC22MV, 20TQC33MV, 16TQC33MV, 16TQC47MV (rated voltage applied)	ΔC/C	Within±20% of the initial value
		tanδ	≤ 1.5 times the initial limit
		L.C.	≤ The initial limit
		ΔC/C	Within+40%, -20% of the initial value
Damp heat (Steady state)	60°C, 90to95%RH, 500h, No voltage applied	tanδ	≤ 1.5 times the initial limit
		L.C.	≤ 3 times the initial limit
		ΔC/C	Within±5% of the initial value
Surge	15to35°C, 1000 times, 1kΩdischarge resistance, surge voltage applied	tanδ	≤ The initial limit
		L.C.	≤ 3 times the initial limit

Dimensions

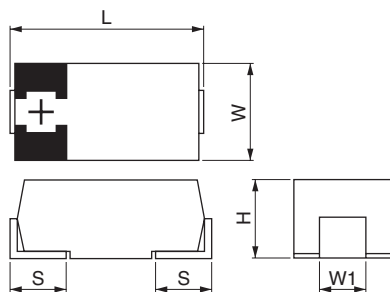

(unit: mm)

Size code	L*1 (±0.2)	W (±0.2)	H*2 (±0.1)	S (±0.2)	W1 (±0.1)
B2	3.5	2.8	1.9	0.8	2.2
C	6.0	3.2	2.8	1.3	1.8
D2	7.3	4.3	1.9	1.3	2.4
D3L	7.3	4.3	2.8	1.3	2.4

★1 ±0.3:D3L ★2 ±0.2:C,D3L

Size List

μF	RV (SV)	16 (20)	20 (23)	25 (29)
5.6				B2
8.2			B2	
10	B2			C
15			C	D2
22	C		D2	D2
33			D2	D3L
47	D2		D3L	
68			D3L	

Characteristics List

Size code	SANYO Part number	Rated Voltage (V)	Rated Temperature (°C)	Rated Capacitance (μF)	Category Voltage (V)	Category Temperature (°C)	D.F. (%max.)	L.C. (μA) max./5min.	E.S.R. (mΩmax.) 100kHz/20°C	Maximum allowable ripple current (mA)rms 100kHz*3	MSL	
											Reflow Temp. ≤ 260°C	Reflow Temp. ≤ 250°C
B2	25TQC5R6M	25*4	85	5.6	20	105	10.0	42.0	100	800	Under evaluation	3
	20TQC8R2M	20	105	8.2	-	-	10.0	49.2	100	800		
	16TQC10M	16	105	10	-	-	10.0	48.0	100	800		
C	25TQC10M	25*4	85	10	20	105	10.0	25.0	95	900		
	20TQC15M	20	105	15	-	-	10.0	30.0	80	1000		
	16TQC22M	16	105	22	-	-	10.0	35.2	80	1000		
D2	25TQC22M	25*4	85	22	20	105	10.0	44.0	90	1000		
	25TQC22MV	25*4	85	22	20	105	10.0	55.0	45	1500		
	25TQC15M	25*4	85	15	20	105	10.0	38.0	90	1000		
	25TQC15MV	25*4	85	15	20	105	10.0	38.0	45	1500		
	20TQC22M	20	105	22	-	-	10.0	44.0	80	1300		
	16TQC33M	16	105	33	-	-	10.0	52.8	70	1400		
	16TQC47M	16	105	47	-	-	10.0	75.2	70	1400		
D3L	25TQC33M	25*4	85	33	20	105	10.0	82.5	60	1400		
	20TQC47M	20	105	47	-	-	10.0	94.0	55	1450		
	16TQC68M	16	105	68	-	-	10.0	108.8	50	1500		

★3 100k to 500kHz, 105°C ★4 Please reduce 0.25V per 1°C from over 85°C for 25V products

APC/APD Series Aluminum Anode Products

Feature

AP series is and has a cost performance advantage and low profile by using aluminum foil for the anode.



Specifications

Items	Condition	Characteristics		
Operating Temperature range	—	-55 to +105 (°C)		
Rated capacitance range	120Hz/20°C	10 to 33 (μF)		
Capacitance tolerance	120Hz/20°C	M:±20%		
Rated voltage	—	4.0 to 6.3 (V.DC)		
Dissipation Factor (D.F.)	120Hz/20°C	≤ 5.0 or 8.0 (%)		
Leakage current	Rated voltage applied, after 5 minutes	Please see the attached characteristics list		
Equivalent series resistance (E.S.R. mΩmax.)	100kHz/20°C	Please see the attached characteristics list		
Temperature characteristics of Impedance ratio	100kHz/+20°C	-55°C	Z/Z _{20°C}	0.9 to 2.0
		+105°C	Z/Z _{20°C}	0.6 to 1.1
Endurance	105°C, 2000h, rated voltage applied	ΔC/C	Within±20% of the initial value	
		D.F.	≤ 1.5 times the initial limit	
		L.C.	≤ The initial limit	
Damp heat (Steady state)	60°C, 90to95%RH, 500h, No voltage applied	ΔC/C	Within+40%, -20% of the initial value	
		D.F.	≤ 1.5 times the initial limit	
		L.C.	≤ 5 times the initial limit	
Surge	105°C, 1000 cycles, 1kΩ discharge resistance, surge voltage applied	ΔC/C	Within±5% of the initial value	
		D.F.	≤ twice the initial limit	
		L.C.	≤ 3 times the initial limit	

Dimensions

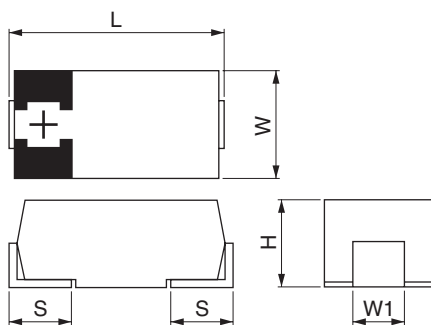

(unit: mm)

Size code	L (±0.2)	W (±0.2)	H (±0.1)	S (±0.2)	W1 (±0.1)
D1	7.3	4.3	1.4	1.3	2.4
D2	7.3	4.3	1.9	1.3	2.4

Size List

μF	RV (sV)	4.0 (5.0)	6.3 (8.0)
	10		D1, D2
15	D1		
22		D2	
33	D2		

Characteristics List

Series	Size code	SANYO Part number	Rated Voltage (V)	Rated Temperature (°C)	Rated Capacitance (μF)	Category Voltage (V)	Category Temperature (°C)	D.F. (%max.)	L.C. (μA) max./5min.	E.S.R. (mΩmax.) 100kHz/20°C	Maximum allowable ripple current (mA rms) 100kHz*1	MSL	
												Reflow Temp. ≤ 260°C	Reflow Temp. ≤ 250°C
APD	D1	6APD10M	6.3	105	10	6.3	105	8.0	2.5	70	1900	Under evaluation	5
		4APD15M	4.0	105	15	4.0	105	8.0	2.4	70	1900		
APC	D2	6APC22M	6.3	105	22	6.3	105	5.0	13.9	40	1900		4
		6APC10M	6.3	105	10	6.3	105	8.0	6.3	70	1900		
		4APC33M	4.0	105	33	4.0	105	5.0	13.2	40	1900		

*1 100k to 500kHz, 45°C



SANYO Electric Co., Ltd. Electronic Device Company

■Sales division(Japan)

1-1 SANYO-cho, Daito, Osaka, 574-8534

Phone: (072)870-6375/6377 FAX: (072)870-1174 <http://www.edc.sanyo.com>

■SANYO Component Europe GmbH

Stahlgruberring 4, 81829 Munich Germany

Phone: 49-(0)89-460095-284 FAX: 49-(0)89-460095-275

■Korea office

9th Floor, Han-Lim Building 146-7, Ssanglim-Dong, Chung-Gu Seoul, Korea

Phone: 82-2-2273-5861 FAX: 82-2-2273-6053

SANYO Electronic Device (U.S.A.) Corporation

■San Diego Headquarter

2055 SANYO Ave., San Diego, CA 92154, U.S.A.

Phone: 1-619-661-6835 FAX: 1-619-661-1055 <http://www.sanyodevice.com>

■San Jose sales office

1230 Oakmead Parkway, Ste. #314, Sunnyvale, CA 94085, U.S.A.

Phone: 1-408-749-9714 FAX: 1-408-749-0212

■Dallas sales office

2600 Network Blvd. 6F. Frisco TX. 75034, U.S.A.

Phone: 1-469-362-5465 FAX: 1-469-362-5463

■Detroit sales office

27000 Meadowbrook Rd., Suite 210 Novi, MI 48377, U.S.A.

Phone: 1-248-344-1245 FAX: 1-248-479-0428

■Hartford sales office

P.O.Box 76 Waterford. CT 06385, U.S.A.

Phone: 1-860-447-9553 FAX: 1-860-447-9573

■Atlanta sales office

P.O. Box 70666, Marietta, GA 30007, U.S.A.

Phone: 1-770-650-5654 FAX: 1-770-640-5081

SANYO Electronic Components (Singapore) Pte., Ltd.

70 Anson Road #19-01 To 08, Apex Tower Singapore/079905/Singapore

Phone: 65-6223-0225 FAX: 65-6223-0986

SANYO Electronic Components (H.K.) Ltd. <http://www.sanyochina.com>

■Hong Kong Headquarter

Suite 3601-06, 36/F, Tower 6, The Gateway, Harbour City, 9 Canton Road, T.S.T., Kowloon, Hong Kong.

Phone: 852-2366-2577 FAX: 852-2301-2255

■Shanghai office

Room2107, Ruijin Building, 205 Mao Min Rd.(S), Shanghai, China

Phone: 86-21-6415-6669 FAX: 86-21-6445-8543

■Shenzhen office

Room301, East Building, High-Tech Plaza, Phase 2, Tian An Cyberpark Futian, Shenzhen, Guangdong
China 518040

Phone: 86-755-8835-2319 FAX: 86-755-8835-2324

■Beijing office

Room708, China Life Tower No.16 Chaoyangmenwai Ave., Beijing, China

Phone: 86-10-8525-2600 FAX: 86-10-8525-2602

■Taiwan Branch(Taiwan)

10F., No.101, Sec.2, Nanjing E. Rd., Jhongsan District, Taipei City 104, Taiwan (R.O.C.)

Phone: 886-2-2536-1855 FAX: 886-2-2536-6168

●Modifying the subjects and specifications in this catalogue without any notice.

