

Cool MOS™ Power Transistor



- New revolutionary high voltage technology
- Ultra low gate charge
- Periodic avalanche rated
- Extreme dv/dt rated
- Optimized capacitances
- Improved noise immunity
- Former development designation:
SPPx5N60S5/SPBx5N60S5

Product Summary

| | | |
|---------------------|-----|----------|
| $V_{DS} @ T_{jmax}$ | 650 | V |
| $R_{DS(on)}$ | 3 | Ω |
| I_D | 1.8 | A |

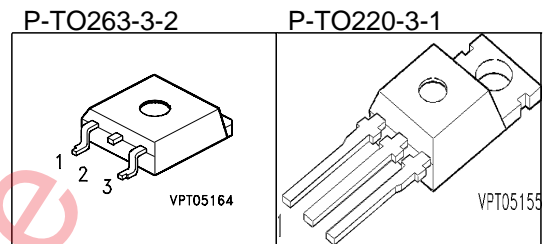

| Type | Package | Ordering Code | Marking |
|------------|-------------|---------------|---------|
| SPP02N60S5 | P-T0220-3-1 | Q67040-S4181 | 02N60S5 |
| SPB02N60S5 | P-T0263-3-2 | Q67040-S4212 | 02N60S5 |

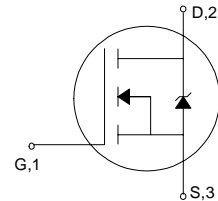

Maximum Ratings, at $T_j = 25^\circ\text{C}$, unless otherwise specified

| Parameter | Symbol | Value | Unit |
|---|----------------------|-------------|-------------------|
| Continuous drain current | I_D | | A |
| $T_C=25^\circ\text{C}$ | | 1.8 | |
| $T_C=100^\circ\text{C}$ | | 1.1 | |
| Pulsed drain current ¹⁾ | $I_{D \text{ puls}}$ | 3.2 | |
| $T_C=25^\circ\text{C}$ | | | |
| Avalanche energy, single pulse | E_{AS} | 50 | mJ |
| $I_D = 1.44 \text{ A}$, $V_{DD} = 50 \text{ V}$ | | | |
| Avalanche energy (repetitive, limited by T_{jmax}) | E_{AR} | 0.07 | |
| $I_D = 1.8 \text{ A}$, $V_{DD} = 50 \text{ V}$ | | | |
| Avalanche current (repetitive, limited by T_{jmax}) | I_{AR} | 1.8 | A |
| Reverse diode dv/dt | dv/dt | 6 | kV/ μs |
| $I_S=1.8\text{A}$, $V_{DS}<V_{DSS}$, $di/dt=100\text{A}/\mu\text{s}$, $T_{jmax}=150^\circ\text{C}$ | | | |
| Gate source voltage | V_{GS} | ± 20 | V |
| Power dissipation | P_{tot} | 25 | W |
| $T_C=25^\circ\text{C}$ | | | |
| Operating and storage temperature | T_j, T_{stg} | -55... +150 | $^\circ\text{C}$ |

Electrical Characteristics, at $T_j = 25\text{ °C}$, unless otherwise specified

| Parameter | Symbol | Values | | | Unit |
|-----------|--------|--------|------|------|------|
| | | min. | typ. | max. | |

Thermal Characteristics

| | | | | | |
|---|------------|---|----|----|-----|
| Thermal resistance, junction - case | R_{thJC} | - | - | 5 | K/W |
| Thermal resistance, junction - ambient (Leaded and through-hole packages) | R_{thJA} | - | - | 62 | |
| SMD version, device on PCB: @ min. footprint @ 6 cm ² cooling area ²⁾ | R_{thJA} | - | - | 62 | |
| | | - | 35 | - | |

Static Characteristics, at $T_j = 25\text{ °C}$, unless otherwise specified

| | | | | | |
|--|---------------|-----|-----|-----|---------------|
| Drain-source breakdown voltage $V_{GS} = 0\text{ V}$, $I_D = 0.25\text{ mA}$ | $V_{(BR)DSS}$ | 600 | - | - | V |
| Gate threshold voltage, $V_{GS} = V_{DS}$ $I_D = 80\text{ }\mu\text{A}$, $T_j = 25\text{ °C}$ | $V_{GS(th)}$ | 3.5 | 4.5 | 5.5 | |
| Zero gate voltage drain current, $V_{DS} = V_{DSS}$ $V_{GS} = 0\text{ V}$, $T_j = 25\text{ °C}$ $V_{GS} = 0\text{ V}$, $T_j = 150\text{ °C}$ | I_{DSS} | - | 0.5 | 1 | μA |
| | | - | - | 50 | |
| Gate-source leakage current $V_{GS} = 20\text{ V}$, $V_{DS} = 0\text{ V}$ | I_{GSS} | - | - | 100 | nA |
| Drain-source on-state resistance $V_{GS} = 10\text{ V}$, $I_D = 1.1\text{ A}$ | $R_{DS(on)}$ | - | 2.7 | 3 | Ω |

¹ current limited by T_{jmax}

² Device on 40mm*40mm*1.5mm epoxy PCB FR4 with 6 cm² (one layer, 70 μm thick) copper area for drain connection. PCB is vertical without blown air.

Electrical Characteristics, at $T_j = 25\text{ }^\circ\text{C}$, unless otherwise specified

| Parameter | Symbol | Conditions | Values | | | Unit |
|-----------|--------|------------|--------|------|------|------|
| | | | min. | typ. | max. | |

Dynamic Characteristics

| | | | | | | |
|------------------------------|--------------|--|---|-----|----|----|
| Transconductance | g_{fs} | $V_{DS} \geq 2 \cdot I_D \cdot R_{DS(on)max}$, $I_D = 1.1\text{A}$ | - | 1.4 | - | S |
| Input capacitance | C_{iss} | $V_{GS} = 0\text{V}$, $V_{DS} = 25\text{V}$, $f = 1\text{MHz}$ | - | 240 | - | pF |
| Output capacitance | C_{oss} | | - | 77 | - | |
| Reverse transfer capacitance | C_{rss} | | - | 4.4 | - | |
| Turn-on delay time | $t_{d(on)}$ | $V_{DD} = 350\text{V}$, $V_{GS} = 10\text{V}$, $I_D = 1.8\text{A}$, $R_G = 50\Omega$ | - | 35 | - | ns |
| Rise time | t_r | | - | 35 | - | |
| Turn-off delay time | $t_{d(off)}$ | | - | 35 | 52 | |
| Fall time | t_f | | - | 20 | 30 | |

Gate Charge Characteristics

| | | | | | | |
|-----------------------|----------|--|---|-----|-----|----|
| Gate to source charge | Q_{gs} | $V_{DD} = 350\text{V}$, $I_D = 1.8\text{A}$ | - | 2.3 | - | nC |
| Gate to drain charge | Q_{gd} | | - | 4.5 | - | |
| Total gate charge | Q_g | $V_{DD} = 350\text{V}$, $I_D = 1.8\text{A}$, $V_{GS} = 0$ to 10V | - | 7.3 | 9.5 | |

Reverse Diode

| | | | | | | |
|--|----------|--|---|-----|------|----|
| Inverse diode continuous forward current | I_S | $T_C = 25\text{ }^\circ\text{C}$ | - | - | 1.8 | A |
| Inverse diode direct current, pulsed | I_{SM} | | - | - | 3.2 | |
| Inverse diode forward voltage | V_{SD} | $V_{GS} = 0\text{V}$, $I_F = 1.8\text{A}$ | - | 1 | 1.2 | V |
| Reverse recovery time | t_{rr} | $V_R = 350\text{V}$, $I_F = I_S$, $di_F/dt = 100\text{A}/\mu\text{s}$ | - | 860 | 1460 | ns |
| Reverse recovery charge | Q_{rr} | | - | 1.6 | - | |

Power dissipation

$$P_{tot} = f(T_C)$$

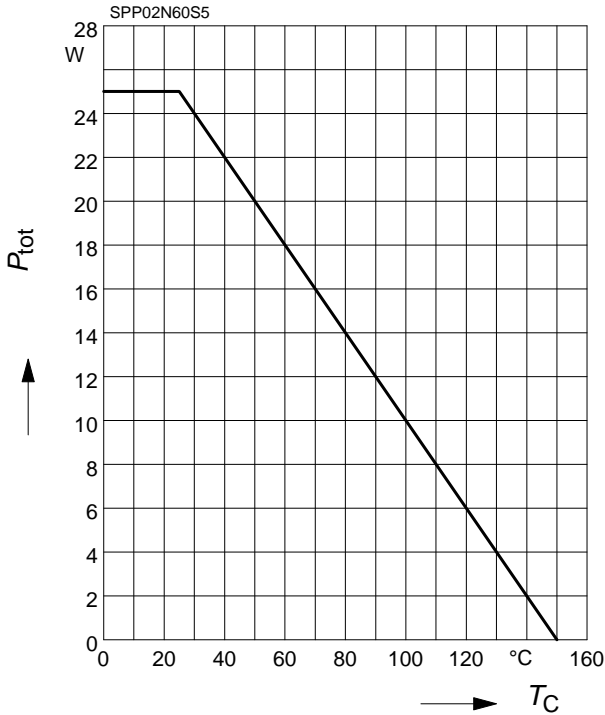

Drain current

$$I_D = f(T_C)$$

parameter: $V_{GS} \geq 10\text{ V}$

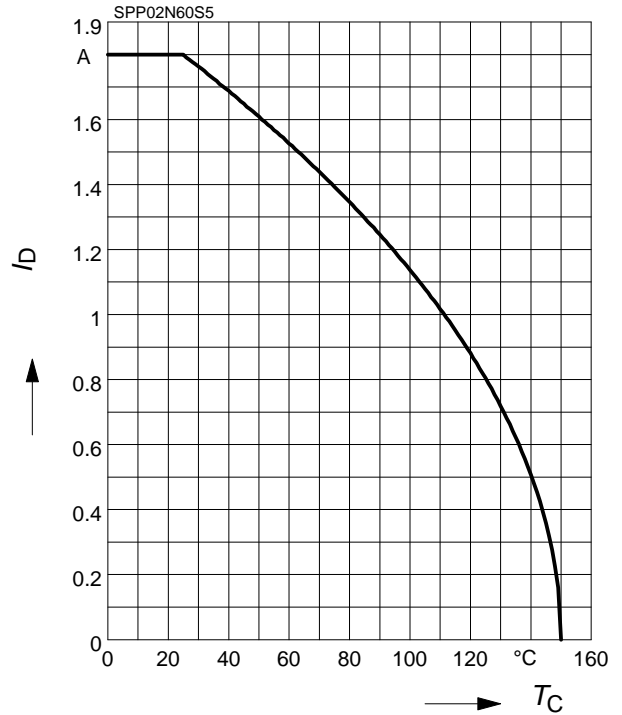

Safe operating area

$$I_D = f(V_{DS})$$

parameter: $D=0.01, T_C=25^\circ\text{C}$

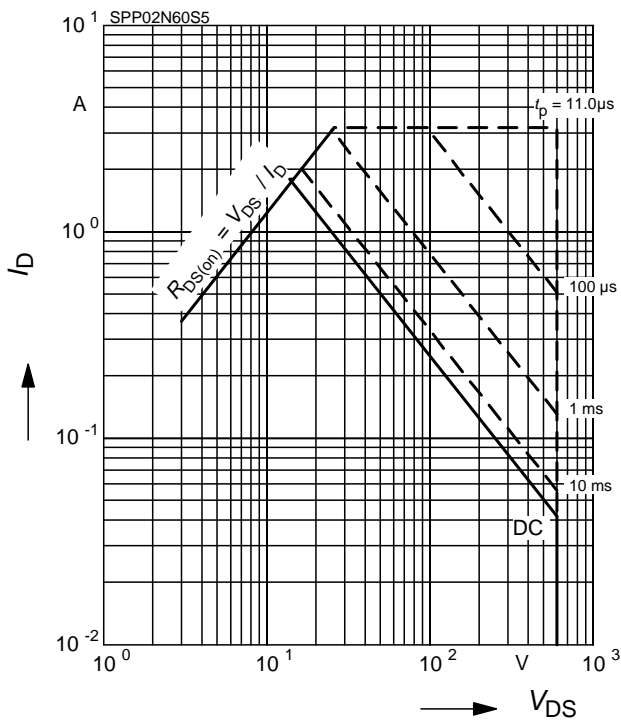

Transient thermal impedance

$$Z_{thJC} = f(t_p)$$

parameter: $D = t_p/T$

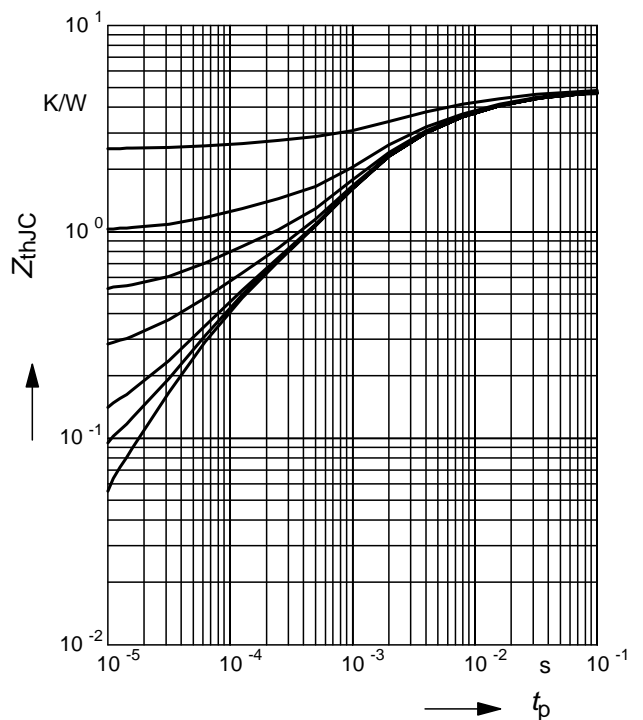

Typ. output characteristic

$I_D = f(V_{DS})$

Parameter: $V_{GS}, T_j = 25\text{ }^\circ\text{C}$

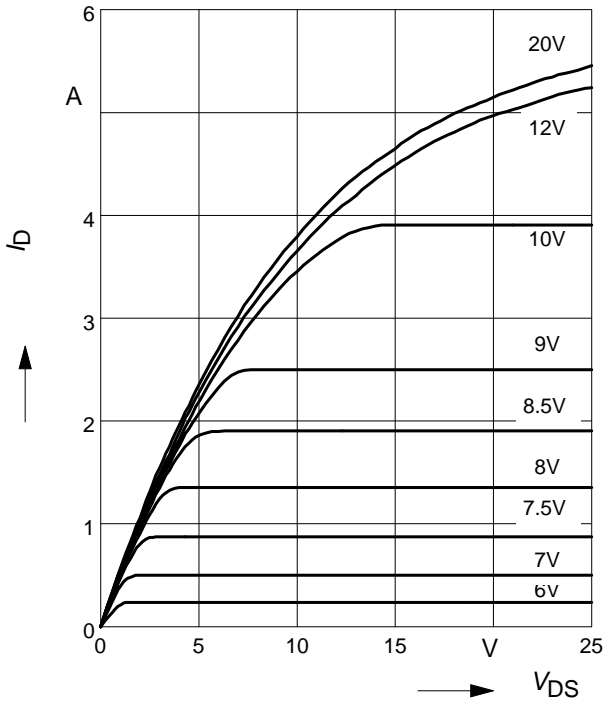

Drain-source on-resistance

$R_{DS(on)} = f(T_j)$

parameter : $I_D = 1.1\text{ A}, V_{GS} = 10\text{ V}$

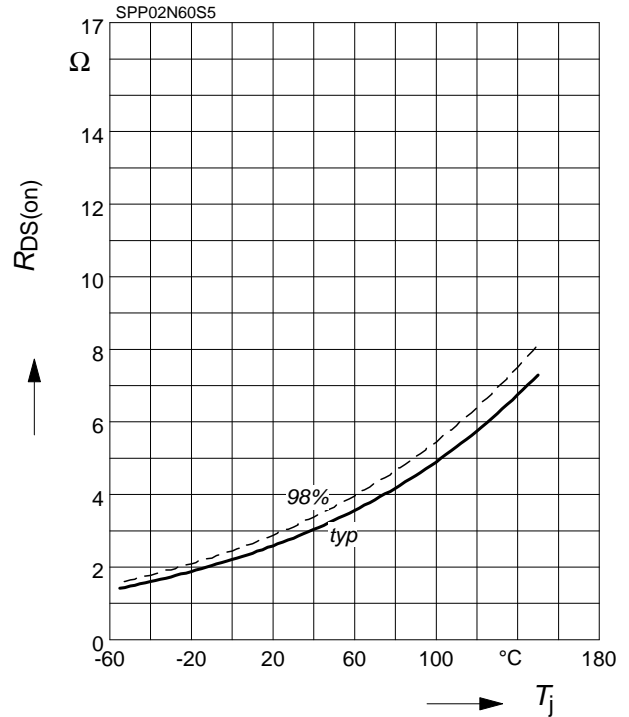

Typ. transfer characteristics

$I_D = f(V_{GS})$

$V_{DS} \geq 2 \times I_D \times R_{DS(on)max}$

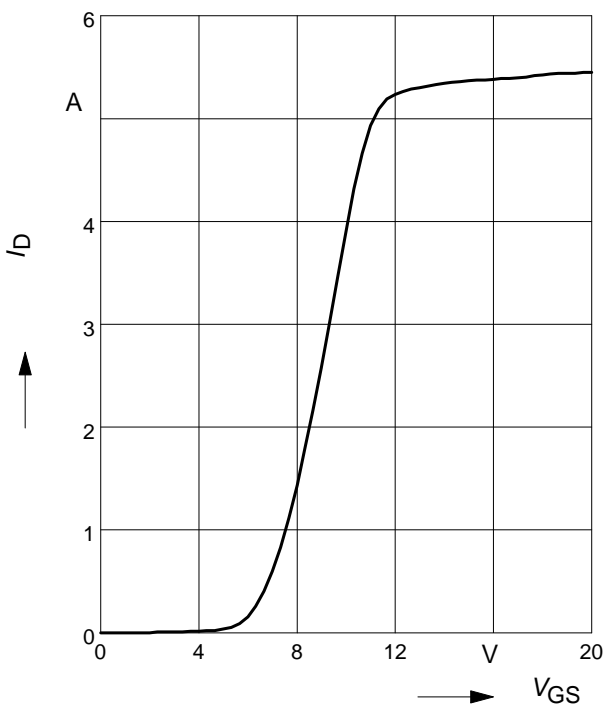

Typ. capacitances

$C = f(V_{DS})$

parameter: $V_{GS} = 0\text{ V}, f = 1\text{ MHz}$

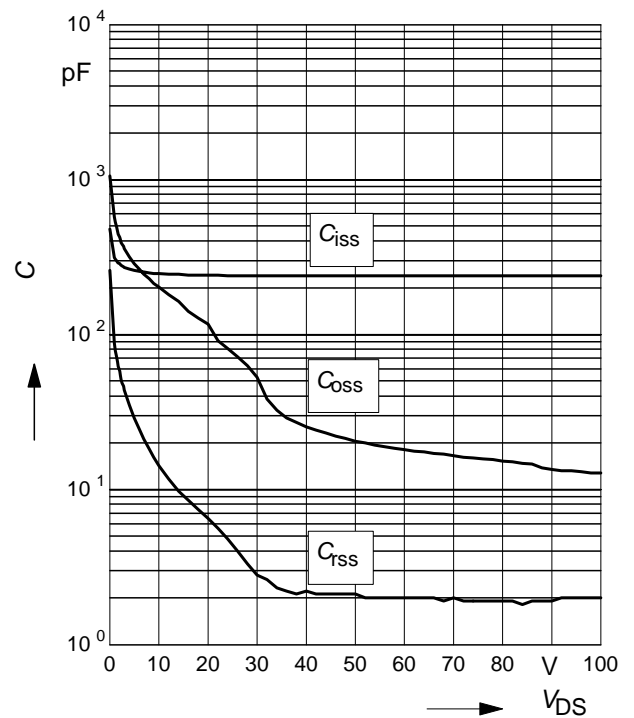

Avalanche energy

$$E_{AS} = f(T_j)$$

par.: $I_D = 1.44A$, $V_{DD} = 50V$

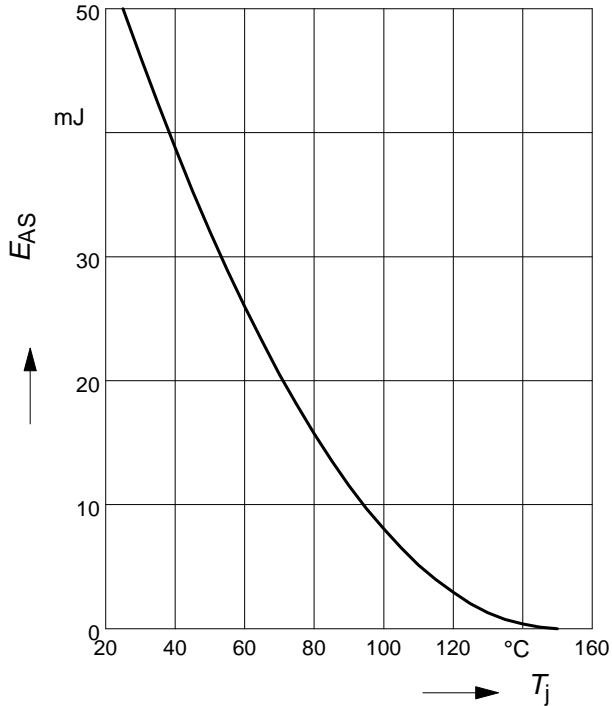

Avalanche SOA

$$I_{AR} = f(t_{AR})$$

par.: $T_j \leq 150\text{ °C}$

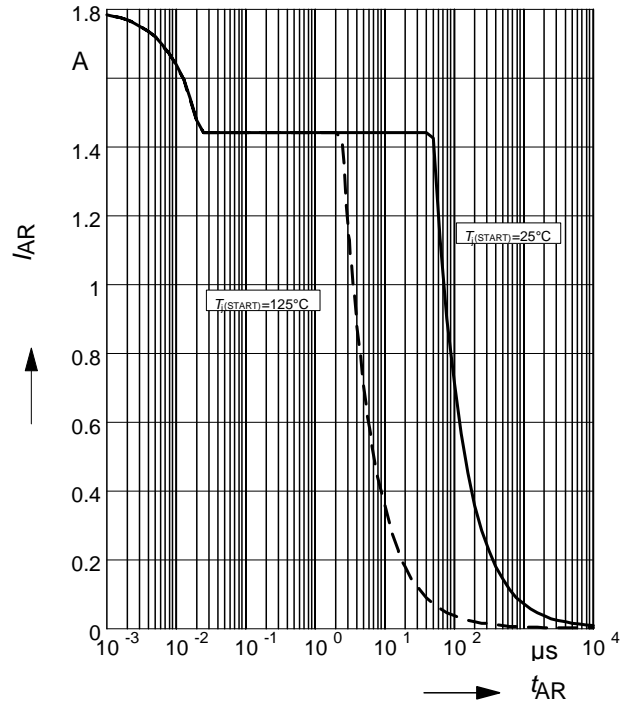

Drain-source breakdown voltage

$$V_{(BR)DSS} = f(T_j)$$

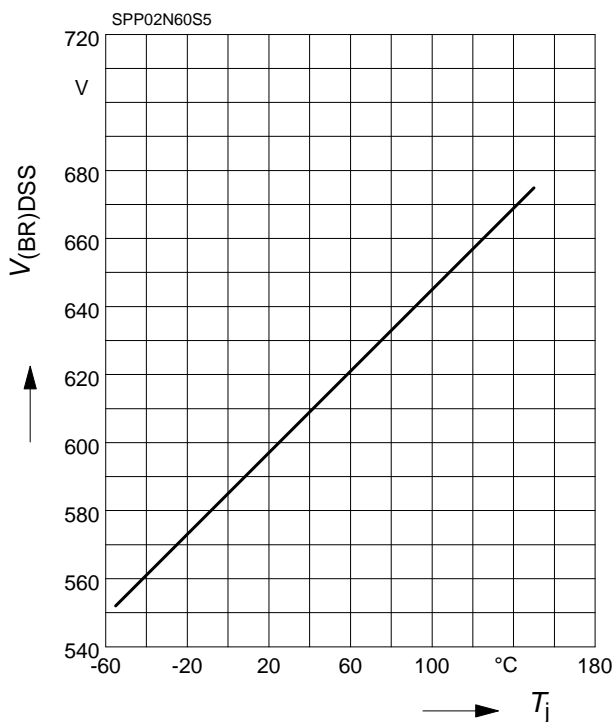

Gate threshold voltage

$$V_{GS(th)} = f(T_j)$$

parameter: $V_{GS} = V_{DS}$, $I_D = 80\text{ }\mu A$

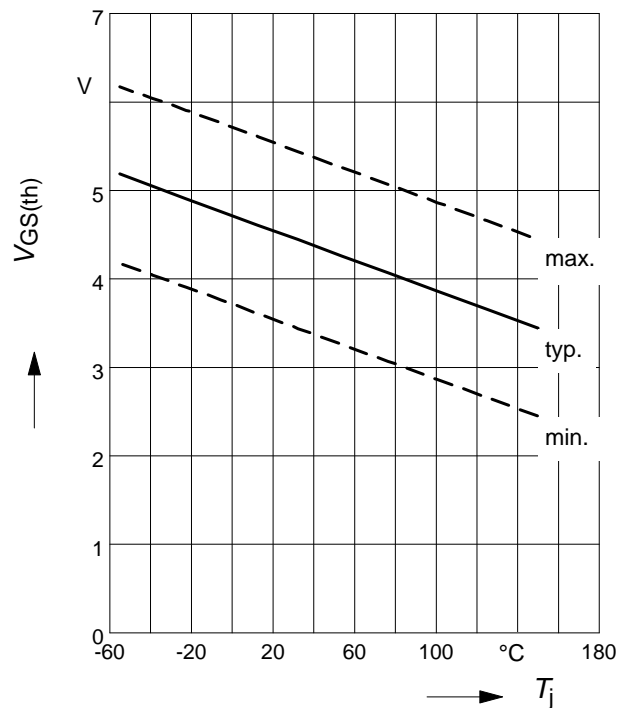

Forward characteristics of reverse diode

$$I_F = f(V_{SD})$$

parameter: T_j , $t_p = 10 \mu s$

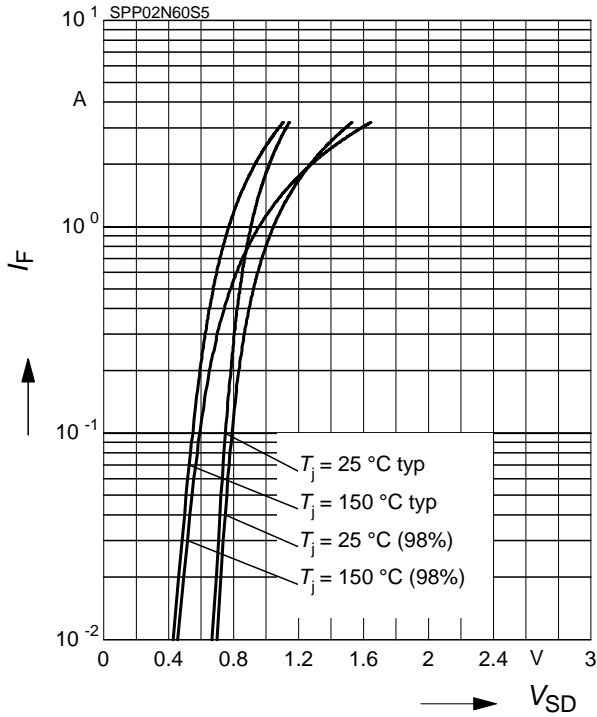

Typ. gate charge

$$V_{GS} = f(Q_{Gate})$$

parameter: $I_D = 1.8 \text{ A pulsed}$

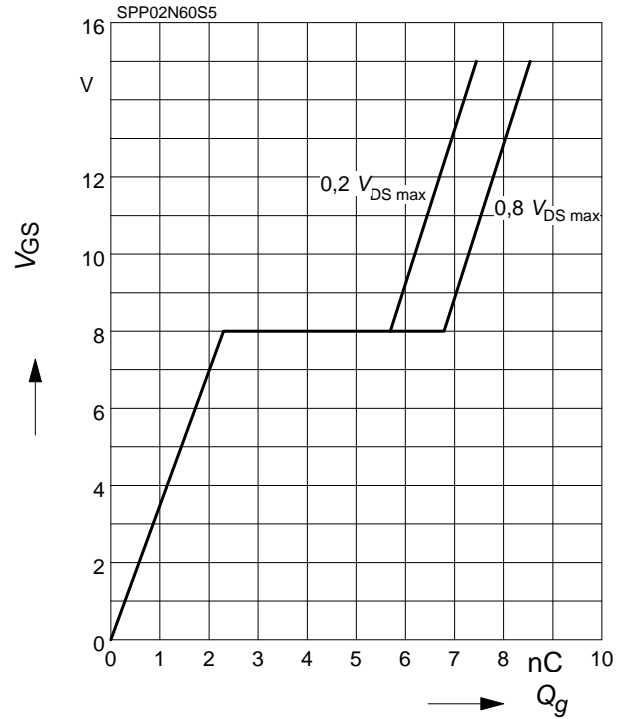

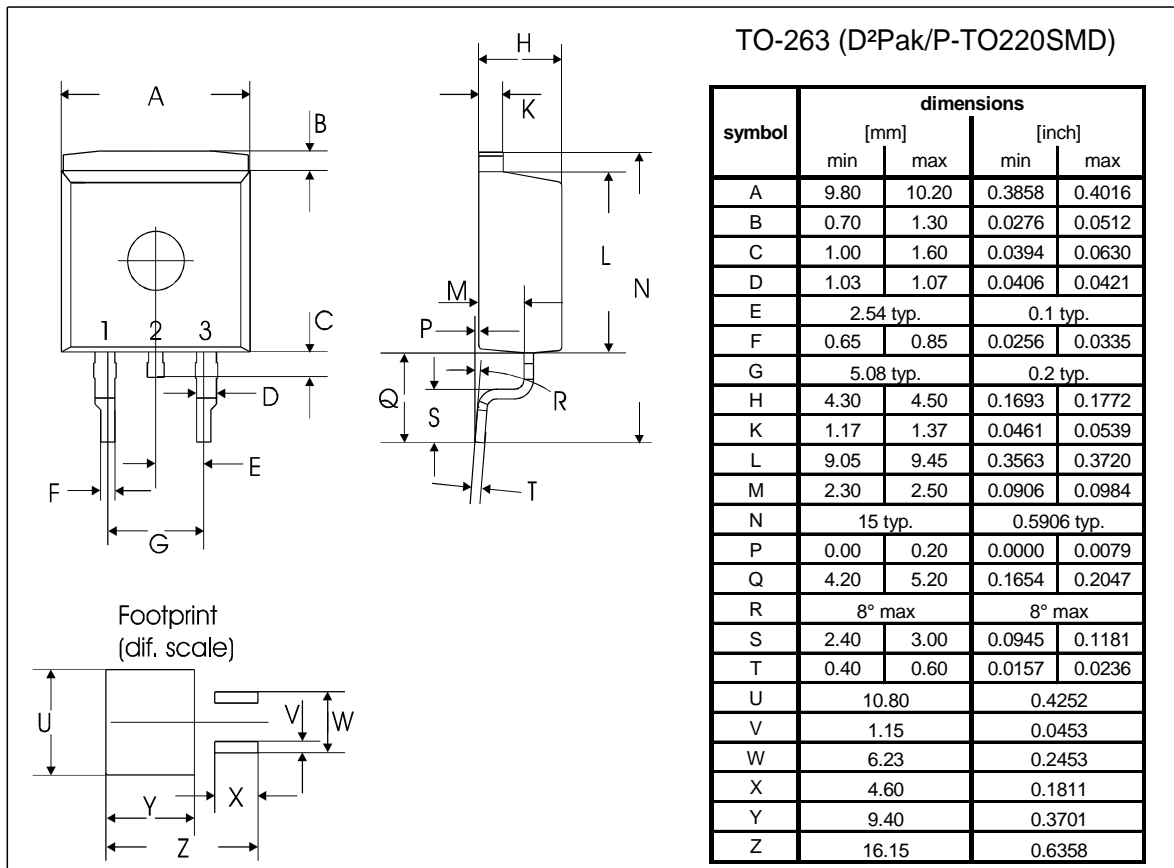
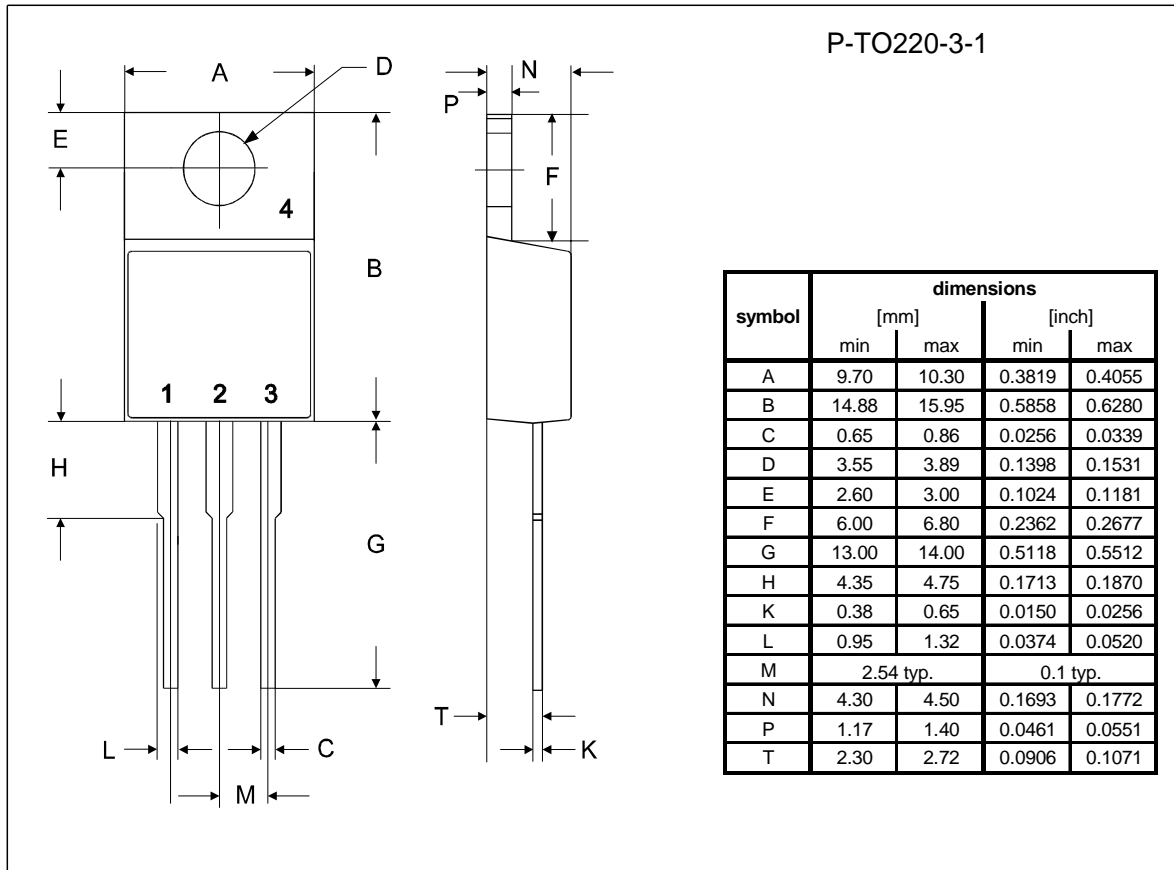

Published by
Infineon Technologies AG,
Bereichs Kommunikation
St.-Martin-Strasse 53,
D-81541 München
© Infineon Technologies AG 1999
All Rights Reserved.

Attention please!

The information herein is given to describe certain components and shall not be considered as warranted characteristics.

Terms of delivery and rights to technical change reserved.

We hereby disclaim any and all warranties, including but not limited to warranties of non-infringement, regarding circuits, descriptions and charts stated herein.

Infineon Technologies is an approved CECC manufacturer.

Information

For further information on technology, delivery terms and conditions and prices please contact your nearest Infineon Technologies Office in Germany or our Infineon Technologies Representatives worldwide (see address list).

Warnings

Due to technical requirements components may contain dangerous substances.

For information on the types in question please contact your nearest Infineon Technologies Office.

Infineon Technologies Components may only be used in life-support devices or systems with the express written approval of Infineon Technologies, if a failure of such components can reasonably be expected to cause the failure of that life-support device or system, or to affect the safety or effectiveness of that device or system. Life support devices or systems are intended to be implanted in the human body, or to support and/or maintain and sustain and/or protect human life. If they fail, it is reasonable to assume that the health of the user or other persons may be endangered.