

Notice for TAIYO YUDEN products

Please read this notice before using the TAIYO YUDEN products.

REMINDERS

- Product information in this catalog is as of October 2012. All of the contents specified herein are subject to change without notice due to technical improvements, etc. Therefore, please check for the latest information carefully before practical application or usage of the Products.

Please note that Taiyo Yuden Co., Ltd. shall not be responsible for any defects in products or equipment incorporating such products, which are caused under the conditions other than those specified in this catalog or individual specification.

- Please contact Taiyo Yuden Co., Ltd. for further details of product specifications as the individual specification is available.
- Please conduct validation and verification of products in actual condition of mounting and operating environment before commercial shipment of the equipment.
- All electronic components or functional modules listed in this catalog are developed, designed and intended for use in general electronics equipment.(for AV, office automation, household, office supply, information service, telecommunications, (such as mobile phone or PC) etc.). Before incorporating the components or devices into any equipment in the field such as transportation,(automotive control, train control, ship control), transportation signal, disaster prevention, medical, public information network (telephone exchange, base station) etc. which may have direct influence to harm or injure a human body, please contact Taiyo Yuden Co., Ltd. for more detail in advance. Do not incorporate the products into any equipment in fields such as aerospace, aviation, nuclear control, submarine system, military, etc. where higher safety and reliability are especially required.

In addition, even electronic components or functional modules that are used for the general electronic equipment, if the equipment or the electric circuit require high safety or reliability function or performances, a sufficient reliability evaluation check for safety shall be performed before commercial shipment and moreover, due consideration to install a protective circuit is strongly recommended at customer's design stage.

- The contents of this catalog are applicable to the products which are purchased from our sales offices or distributors (so called "TAIYO YUDEN' s official sales channel").
It is only applicable to the products purchased from any of TAIYO YUDEN' s official sales channel.
- Please note that Taiyo Yuden Co., Ltd. shall have no responsibility for any controversies or disputes that may occur in connection with a third party's intellectual property rights and other related rights arising from your usage of products in this catalog. Taiyo Yuden Co., Ltd. grants no license for such rights.
- Caution for export
Certain items in this catalog may require specific procedures for export according to "Foreign Exchange and Foreign Trade Control Law" of Japan, "U.S. Export Administration Regulations", and other applicable regulations. Should you have any question or inquiry on this matter, please contact our sales staff.

MULTILAYER CERAMIC CAPACITORS



WAVE

REFLOW

PARTS NUMBER

J	M	K	3	1	6	△	B	J	1	0	6	M	L	-	T	△
①	②	③	④	⑤	⑥	⑦	⑧	⑨	⑩	⑪	⑫					

△=Blank space

① Rated voltage

Code	Rated voltage [VDC]
P	2.5
A	4
J	6.3
L	10
E	16
T	25
G	35
U	50
H	100
Q	250
S	630

③ End termination

Code	End termination
K	Plated
R	High Reliability Application

② Series name

Code	Series name
M	Multilayer ceramic capacitor
V	Multilayer ceramic capacitor for high frequency
W	LW reverse type multilayer capacitor

④ Dimension (L × W)

Type	Dimensions (L × W) [mm]	EIA (inch)
042	0.4 × 0.2	01005
063	0.6 × 0.3	0201
105	1.0 × 0.5	0402
	0.52 × 1.0 ※	0204
107	1.6 × 0.8	0603
	0.8 × 1.6 ※	0306
212	2.0 × 1.25	0805
	1.25 × 2.0 ※	0508
316	3.2 × 1.6	1206
325	3.2 × 2.5	1210
432	4.5 × 3.2	1812

Note : ※LW reverse type (□WK) only

⑤ Dimension tolerance

Code	Type	L [mm]	W [mm]	T [mm]	
△	ALL	Standard	Standard	Standard	
	063	0.6 ± 0.05	0.3 ± 0.05	0.3 ± 0.05	
	105	1.0 ± 0.10	0.5 ± 0.10	0.5 ± 0.10	
	107	1.6 + 0.15 / - 0.05	0.8 + 0.15 / - 0.05	0.8 + 0.15 / - 0.05	
A	212	2.0 + 0.15 / - 0.05	1.25 + 0.15 / - 0.05	0.45 ± 0.05 0.85 ± 0.10 1.25 + 0.15 / - 0.05	
	316	3.2 ± 0.20	1.25 ± 0.20	0.85 ± 0.10 1.6 ± 0.20	
	325	3.2 ± 0.30	2.5 ± 0.30	2.5 ± 0.30	
	B	105	1.0 + 0.15 / - 0.05	0.5 + 0.15 / - 0.05	0.5 + 0.15 / - 0.05 0.45 ± 0.05 0.8 + 0.20 / - 0
		107	1.6 + 0.20 / - 0	0.8 + 0.20 / - 0	0.85 ± 0.10 1.25 + 0.20 / - 0
212		2.0 + 0.20 / - 0	1.25 + 0.20 / - 0	1.6 ± 0.30	
C	316	3.2 ± 0.30	1.6 ± 0.30	1.6 ± 0.30	
	105	1.0 + 0.20 / - 0	0.5 + 0.20 / - 0	0.5 + 0.20 / - 0	

Note: P.6 Standard external dimensions

△= Blank space

⑥ Temperature characteristics code

■ High dielectric type (Excluding Super low distortion multilayer ceramic capacitor (FCAP™))

Code	Applicable standard		Temperature range [°C]	Ref. Temp. [°C]	Capacitance change	Capacitance tolerance	Tolerance code
BJ	JIS	B	-25 ~ + 85	20	± 10%	± 10%	K
	EIA	X5R	-55 ~ + 85	25		± 15%	± 20%
B7	EIA	X7R	-55 ~ + 125	25	± 15%	± 10%	K
						± 20%	M
C6	EIA	X6S	-55 ~ + 105	25	± 22%	± 10%	K
						± 20%	M
C7	EIA	X7S	-55 ~ + 125	25	± 22%	± 10%	K
						± 20%	M
LD(※)	EIA	X5R	-55 ~ + 85	25	± 15%	± 10%	K
						± 20%	M
△F	JIS	F	-25 ~ + 85	20	+30 / -80%	+80 / -20%	Z
	EIA	Y5V	-30 ~ + 85	25			+22 - 82%

Note : ※LD Low distortion high value multilayer ceramic capacitor

△= Blank space

► This catalog contains the typical specification only due to the limitation of space. When you consider the purchase of our products, please check our specification. For details of each product (characteristics graph, reliability information, precautions for use, and so on), see our Web site (<http://www.ty-top.com/>).

■ Temperature compensating type

Code	Applicable standard		Temperature range [°C]	Ref. Temp. [°C]	Capacitance change	Capacitance tolerance	Tolerance code
CH	JIS	CH	-55 ~ +125	20	0 ± 60ppm/°C	±0.1pF	B
		C0H				±0.25pF	C
	EIA	C0H		25		±0.5pF	D
				±1pF		F	
				±5%		J	
±10%	K						
CJ	JIS	CJ	-55 ~ +125	20	0 ± 120ppm/°C	±0.25pF	C
	EIA	C0J		25			
CK	JIS	CK	-55 ~ +125	20	0 ± 250ppm/°C	±0.25pF	C
	EIA	C0J		25			
UJ	JIS	UJ	-55 ~ +125	20	-750 ± 120ppm/°C	±0.25pF	C
	EIA	U2J		25		±0.5pF	D
±5%			J				
UK	JIS	UK	-55 ~ +125	20	-750 ± 250ppm/°C	±0.5pF	C
	EIA	U2K	-55 ~ +125	25			
SL	JIS	S	-55 ~ +125	20	+350 ~ -1000ppm/°C	±5%	J

⑥ Series code

(Super low distortion multilayer ceramic capacitor (CFCAP™) only)

Code	Series code
SD	Standard

⑦ Nominal capacitance

Code (example)	Nominal capacitance
0R5	0.5pF
010	1pF
100	10pF
101	100p
102	1,000pF
103	10,000pF
104	0.1 μF
105	1.0 μF
106	10 μF
107	100 μF

Note : R=Decimal point

⑧ Capacitance tolerance

Code	Capacitance tolerance
B	±0.1pF
C	±0.25pF
D	±0.5pF
F	±1pF
J	±5%
K	±10%
M	±20%
Z	+80/-20%

⑨ Thickness

Code	Thickness [mm]
C	0.2
D	0.2(Temperature compensating of 042type)
P	0.3
T	
K	0.45
V	0.5
W	
A	0.8
D	0.85(212type or more)
F	1.15
G	1.25
L	1.6
N	1.9
Y	2.0 max
M	2.5

⑩ Special code

Code	Special code
-	Standard

⑪ Packaging

Code	Packaging
F	φ 178mm Taping (2mm pitch)
T	φ 178mm Taping (4mm pitch)
P	φ 178mm Taping (4mm pitch, 1000 pcs/reel) 325 type (Thickness code M)
W	φ 178mm Taping (1mm pitch) 042type only

⑫ Internal code

Code	Internal code
Δ	Standard

■ STANDARD EXTERNAL DIMENSIONS

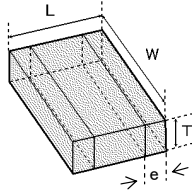
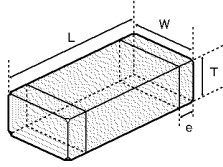

※ LW reverse type

Type(EIA)	Dimension [mm]				
	L	W	T	*1	e
□MK042(01005)	0.4±0.02	0.2±0.02	0.2±0.02	C D	0.1±0.03
□MK063(0201)	0.6±0.03	0.3±0.03	0.3±0.03	P T	0.15±0.05
□MK105(0402)	1.0±0.05	0.5±0.05	0.2±0.02	C	0.25±0.10
			0.3±0.03	P	
			0.5±0.05	V	
□VK105(0402)	1.0±0.05	0.5±0.05	0.5±0.05	W	0.25±0.10
□WK105(0204)※	0.52±0.05	1.0±0.05	0.3±0.05	P	0.18±0.08
□MK107(0603)	1.6±0.10	0.8±0.10	0.45±0.05	K	0.35±0.25
			0.8±0.10	A	
□MR107(0603)	1.6±0.10	0.8±0.10	0.8±0.10	A	0.1~0.6
□WK107(0306)※	0.8±0.10	1.6±0.10	0.5±0.05	V	0.25±0.15
□MK212(0805)	2.0±0.10	1.25±0.10	0.45±0.05	K	0.5±0.25
			0.85±0.10	D	
			1.25±0.10	G	
□MR212(0805)	2.0±0.10	1.25±0.10	1.25±0.10	G	0.25~0.75
□WK212(0508)※	1.25±0.15	2.0±0.15	0.85±0.1	D	0.3±0.2
□MK316(1206)	3.2±0.15	1.6±0.15	0.85±0.10	D	0.5+0.35/-0.25
			1.15±0.10	F	
			1.25±0.10	G	
			1.6±0.20	L	
□MR316(1206)	3.2±0.15	1.6±0.15	1.6±0.20	L	0.25~0.85
□MK325(1210)	3.2±0.30	2.5±0.20	0.85±0.10	D	0.6±0.3
			1.15±0.10	F	
			1.9±0.20	N	
			1.9+0.1/-0.2	Y	
			2.5±0.20	M	
□MR325(1210)	3.2±0.30	2.5±0.20	1.9±0.20	N	0.3~0.9
□MK432(1812)	4.5±0.40	3.2±0.30	2.5±0.20	M	0.9±0.6
			2.5±0.20	M	

Note : ※. LW reverse type, *1.Thickness code

■ STANDARD QUANTITY

Type	EIA (inch)	Dimension		Standard quantity [pcs]	
		[mm]	Code	Paper tape	Embossed tape
042	01005	0.2	C	—	40000
			D		
063	0201	0.3	P	15000	—
			T		
105	0402	0.2	C	20000	—
			P	15000	—
		0.5	V	10000	—
			W		
0204 ※	0.30	P	—	—	
107	0603	0.45	K	4000	—
		0.8	A		
	0306 ※	0.50	V	—	4000
212	0805	0.45	K	4000	—
			D		
		1.25	G	—	3000
			0.85	D	4000
316	1206	0.85	D	4000	—
			G		
		1.6	L	—	2000
			—	—	—
325	1210	0.85	D	—	2000
		1.15	F		
		1.9	N		
		2.0 max	Y		
		2.5	M		
432	1812	2.5	M	—	500(T), 1000(P)
			M	—	500

Note : ※.LW Reverse type(□WK)

▶ This catalog contains the typical specification only due to the limitation of space. When you consider the purchase of our products, please check our specification. For details of each product (characteristics graph, reliability information, precautions for use, and so on), see our Web site (<http://www.ty-top.com/>).

■ PARTS NUMBER

[Temperature Characteristic SD : Standard] 0.85mm thickness (D)

Part number 1	Part number 2	Rated voltage [V]	Temperature characteristics	Capacitance [F]	Capacitance tolerance [%]	tan δ [%]	HALT	Thickness*3 [mm]	Soldering R:Reflow W:Wave
							Rated voltage x %		
UMK212 SD392KD-T		50	Standard Type	3900 p	±10	0.1	200	0.85±0.10	R
UMK212 SD472KD-T				4700 p	±10	0.1	200	0.85±0.10	R
UMK212 SD562KD-T				5600 p	±10	0.1	200	0.85±0.10	R
UMK212 SD682KD-T				6800 p	±10	0.1	200	0.85±0.10	R
UMK212 SD822KD-T				8200 p	±10	0.1	200	0.85±0.10	R
UMK212 SD103KD-T				10000 p	±10	0.1	200	0.85±0.10	R
GMK212 SD123KD-T		35	Standard Type	12000 p	±10	0.1	200	0.85±0.10	R
GMK212 SD153KD-T				15000 p	±10	0.1	200	0.85±0.10	R
EMK212 SD333KD-T		16		33000 p	±10	0.1	200	0.85±0.10	R
LMK212 SD473KD-T		10		47000 p	±10	0.1	200	0.85±0.10	R

● 316TYPE

[Temperature Characteristic SD : Standard] 1.6mm thickness (L)

Part number 1	Part number 2	Rated voltage [V]	Temperature characteristics	Capacitance [F]	Capacitance tolerance [%]	tan δ [%]	HALT	Thickness*3 [mm]	Soldering R:Reflow W:Wave
							Rated voltage x %		
TMK316 SD823KL-T		25	Standard Type	82000 p	±10	0.1	200	1.6±0.20	R
TMK316 SD104KL-T				0.1 μ	±10	0.1	200	1.6±0.20	R

[Temperature Characteristic SD : Standard] 1.15mm thickness (F)

Part number 1	Part number 2	Rated voltage [V]	Temperature characteristics	Capacitance [F]	Capacitance tolerance [%]	tan δ [%]	HALT	Thickness*3 [mm]	Soldering R:Reflow W:Wave
							Rated voltage x %		
GMK316 SD333KF-T		35	Standard Type	33000 p	±10	0.1	200	1.15±0.10	R
GMK316 SD393KF-T				39000 p	±10	0.1	200	1.15±0.10	R
TMK316 SD473KF-T		25	Standard Type	47000 p	±10	0.1	200	1.15±0.10	R
TMK316 SD563KF-T				56000 p	±10	0.1	200	1.15±0.10	R
TMK316 SD683KF-T				68000 p	±10	0.1	200	1.15±0.10	R

Low Distortion High Value Multilayer Ceramic Capacitors(CF LD)

● 107TYPE

[Temperature Characteristic LD : X5R] 0.8mm thickness (A)

Part number 1	Part number 2	Rated voltage [V]	Temperature characteristics	Capacitance [F]	Capacitance tolerance [%]	tan δ [%]	HALT	Thickness*3 [mm]	Soldering R:Reflow W:Wave
							Rated voltage x %		
TMK107BLD105□A-T		25	X5R	1 μ	±10, ±20	10	150	0.8±0.20/-0	R

● 212TYPE

[Temperature Characteristic LD : X5R] 1.25mm thickness (G)

Part number 1	Part number 2	Rated voltage [V]	Temperature characteristics	Capacitance [F]	Capacitance tolerance [%]	tan δ [%]	HALT	Thickness*3 [mm]	Soldering R:Reflow W:Wave
							Rated voltage x %		
GMK212 LD105□G-T		35	X5R	1 μ	±10, ±20	10	150	1.25±0.10	R
GMK212BLD225□G-T			X5R	2.2 μ	±10, ±20	10	150	1.25±0.20/-0	R

● 316TYPE

[Temperature Characteristic LD : X5R] 1.6mm thickness (L)

Part number 1	Part number 2	Rated voltage [V]	Temperature characteristics	Capacitance [F]	Capacitance tolerance [%]	tan δ [%]	HALT	Thickness*3 [mm]	Soldering R:Reflow W:Wave
							Rated voltage x %		
UMK316 LD105□L-T		50	X5R	1 μ	±10, ±20	10	150	1.6±0.20	R
GMK316BLD475□L-T		35	X5R	4.7 μ	±10, ±20	10	150	1.6±0.30	R
TMK316BLD106□L-T		25	X5R	10 μ	±10, ±20	10	150	1.6±0.30	R

● 325TYPE

[Temperature Characteristic LD : X5R] 1.9mm thickness (N)

Part number 1	Part number 2	Rated voltage [V]	Temperature characteristics	Capacitance [F]	Capacitance tolerance [%]	tan δ [%]	HALT	Thickness*3 [mm]	Soldering R:Reflow W:Wave
							Rated voltage x %		
UMK325 LD105□N-T		50	X5R	1 μ	±10, ±20	10	200	1.9±0.20	R

Medium-High Voltage Multilayer Ceramic Capacitor

● 107TYPE

[Temperature Characteristic BJ : B/X5R] 0.8mm thickness (A)

Part number 1	Part number 2	Rated voltage [V]	Temperature characteristics	Capacitance [F]	Capacitance tolerance [%]	tan δ [%]	HALT	Thickness*3 [mm]	Soldering R:Reflow W:Wave	
							Rated voltage x %			
HMK107 BJ102□A-T		100	B	X5R ⁺¹	1000 p	±10, ±20	3.5	200	0.8±0.10	R
HMK107 BJ152□A-T			B	X5R ⁺¹	1500 p	±10, ±20	3.5	200	0.8±0.10	R
HMK107 BJ222□A-T			B	X5R ⁺¹	2200 p	±10, ±20	3.5	200	0.8±0.10	R
HMK107 BJ332□A-T			B	X5R ⁺¹	3300 p	±10, ±20	3.5	200	0.8±0.10	R
HMK107 BJ472□A-T			B	X5R ⁺¹	4700 p	±10, ±20	3.5	200	0.8±0.10	R
HMK107 BJ682□A-T			B	X5R ⁺¹	6800 p	±10, ±20	3.5	200	0.8±0.10	R
HMK107 BJ103□A-T			B	X5R ⁺¹	10000 p	±10, ±20	3.5	200	0.8±0.10	R
HMK107 BJ153□A-T			B	X5R ⁺¹	15000 p	±10, ±20	3.5	200	0.8±0.10	R
HMK107 BJ223□A-T			B	X5R ⁺¹	22000 p	±10, ±20	3.5	200	0.8±0.10	R
HMK107 BJ333□A-T			B	X5R ⁺¹	33000 p	±10, ±20	3.5	200	0.8±0.10	R
HMK107 BJ104□A-T			B	X5R ⁺¹	0.1 μ	±10, ±20	3.5	200	0.8±0.10	R

▶ This catalog contains the typical specification only due to the limitation of space. When you consider the purchase of our products, please check our specification. For details of each product (characteristics graph, reliability information, precautions for use, and so on), see our Web site (<http://www.ty-top.com/>).

[Temperature Characteristic B7 : X7R , C7 : X7S] 0.8mm thickness(A)

Part number 1	Part number 2	Rated voltage [V]	Temperature characteristics	Capacitance [F]	Capacitance tolerance [%]	tan δ [%]	HALT		Thickness*3 [mm]	Soldering R:Reflow W:Wave
							Rated voltage x %			
HMK107 B7102□A-T		100	X7R	1000 p	±10, ±20	3.5	200		0.8±0.10	R
HMK107 B7152□A-T			X7R	1500 p	±10, ±20	3.5	200		0.8±0.10	R
HMK107 B7222□A-T			X7R	2200 p	±10, ±20	3.5	200		0.8±0.10	R
HMK107 B7332□A-T			X7R	3300 p	±10, ±20	3.5	200		0.8±0.10	R
HMK107 B7472□A-T			X7R	4700 p	±10, ±20	3.5	200		0.8±0.10	R
HMK107 B7682□A-T			X7R	6800 p	±10, ±20	3.5	200		0.8±0.10	R
HMK107 B7103□A-T			X7R	10000 p	±10, ±20	3.5	200		0.8±0.10	R
HMK107 B7153□A-T			X7R	15000 p	±10, ±20	3.5	200		0.8±0.10	R
HMK107 B7223□A-T			X7R	22000 p	±10, ±20	3.5	200		0.8±0.10	R
HMK107 B7333□A-T			X7R	33000 p	±10, ±20	3.5	200		0.8±0.10	R
HMK107 C7104□A-T			X7S	0.1 μ	±10, ±20	3.5	200		0.8±0.10	R

212TYPE

[Temperature Characteristic BJ : B/X5R] 1.25mm thickness(G)

Part number 1	Part number 2	Rated voltage [V]	Temperature characteristics	Capacitance [F]	Capacitance tolerance [%]	tan δ [%]	HALT		Thickness*3 [mm]	Soldering R:Reflow W:Wave	
							Rated voltage x %				
HMK212 BJ103□G-T		100	B X5R ⁺	10000 p	±10, ±20	3.5	200		1.25±0.10	R	
HMK212 BJ153□G-T			B X5R ⁺	15000 p	±10, ±20	3.5	200		1.25±0.10	R	
HMK212 BJ223□G-T			B X5R ⁺	22000 p	±10, ±20	3.5	200		1.25±0.10	R	
HMK212 BJ333□G-T			B X5R ⁺	33000 p	±10, ±20	3.5	200		1.25±0.10	R	
HMK212 BJ473□G-T			B X5R ⁺	47000 p	±10, ±20	3.5	200		1.25±0.10	R	
HMK212 BJ683□G-T			B X5R ⁺	68000 p	±10, ±20	3.5	200		1.25±0.10	R	
HMK212 BJ104□G-T			B X5R ⁺	0.1 μ	±10, ±20	3.5	200		1.25±0.10	R	
HMK212 BJ224□G-T			B X5R ⁺	0.22 μ	±10, ±20	3.5	200		1.25±0.10	R	
QMK212 BJ472□G-T			250	B X5R ⁺	4700 p	±10, ±20	2.5	150		1.25±0.10	R
QMK212 BJ682□G-T				B X5R ⁺	6800 p	±10, ±20	2.5	150		1.25±0.10	R
QMK212 BJ103□G-T				B X5R ⁺	10000 p	±10, ±20	2.5	150		1.25±0.10	R
QMK212 BJ153□G-T				B X5R ⁺	15000 p	±10, ±20	2.5	150		1.25±0.10	R
QMK212 BJ223□G-T		B X5R ⁺		22000 p	±10, ±20	2.5	150		1.25±0.10	R	

[Temperature Characteristic BJ : B/X5R] 0.85mm thickness(D)

Part number 1	Part number 2	Rated voltage [V]	Temperature characteristics	Capacitance [F]	Capacitance tolerance [%]	tan δ [%]	HALT		Thickness*3 [mm]	Soldering R:Reflow W:Wave
							Rated voltage x %			
QMK212 BJ102□D-T		250	B X5R ⁺	1000 p	±10, ±20	2.5	150		0.85±0.10	R
QMK212 BJ152□D-T			B X5R ⁺	1500 p	±10, ±20	2.5	150		0.85±0.10	R
QMK212 BJ222□D-T			B X5R ⁺	2200 p	±10, ±20	2.5	150		0.85±0.10	R
QMK212 BJ332□D-T			B X5R ⁺	3300 p	±10, ±20	2.5	150		0.85±0.10	R

[Temperature Characteristic B7 : X7R] 1.25mm thickness(G)

Part number 1	Part number 2	Rated voltage [V]	Temperature characteristics	Capacitance [F]	Capacitance tolerance [%]	tan δ [%]	HALT		Thickness*3 [mm]	Soldering R:Reflow W:Wave	
							Rated voltage x %				
HMK212 B7103□G-T		100	X7R	10000 p	±10, ±20	3.5	200		1.25±0.10	R	
HMK212 B7153□G-T			X7R	15000 p	±10, ±20	3.5	200		1.25±0.10	R	
HMK212 B7223□G-T			X7R	22000 p	±10, ±20	3.5	200		1.25±0.10	R	
HMK212 B7333□G-T			X7R	33000 p	±10, ±20	3.5	200		1.25±0.10	R	
HMK212 B7473□G-T			X7R	47000 p	±10, ±20	3.5	200		1.25±0.10	R	
HMK212 B7683□G-T			X7R	68000 p	±10, ±20	3.5	200		1.25±0.10	R	
HMK212 B7104□G-T			X7R	0.1 μ	±10, ±20	3.5	200		1.25±0.10	R	
HMK212 B7224□G-T			X7R	0.22 μ	±10, ±20	3.5	200		1.25±0.10	R	
QMK212 B7472□G-T			250	X7R	4700 p	±10, ±20	2.5	150		1.25±0.10	R
QMK212 B7682□G-T				X7R	6800 p	±10, ±20	2.5	150		1.25±0.10	R
QMK212 B7103□G-T				X7R	10000 p	±10, ±20	2.5	150		1.25±0.10	R
QMK212 B7153□G-T				X7R	15000 p	±10, ±20	2.5	150		1.25±0.10	R
QMK212 B7223□G-T		X7R		22000 p	±10, ±20	2.5	150		1.25±0.10	R	

[Temperature Characteristic B7 : X7R] 0.85mm thickness(D)

Part number 1	Part number 2	Rated voltage [V]	Temperature characteristics	Capacitance [F]	Capacitance tolerance [%]	tan δ [%]	HALT		Thickness*3 [mm]	Soldering R:Reflow W:Wave
							Rated voltage x %			
QMK212 B7102□D-T		250	X7R	1000 p	±10, ±20	2.5	150		0.85±0.10	R
QMK212 B7152□D-T			X7R	1500 p	±10, ±20	2.5	150		0.85±0.10	R
QMK212 B7222□D-T			X7R	2200 p	±10, ±20	2.5	150		0.85±0.10	R
QMK212 B7332□D-T			X7R	3300 p	±10, ±20	2.5	150		0.85±0.10	R

316TYPE

[Temperature Characteristic BJ : B/X5R] 1.6mm thickness(L)

Part number 1	Part number 2	Rated voltage [V]	Temperature characteristics	Capacitance [F]	Capacitance tolerance [%]	tan δ [%]	HALT		Thickness*3 [mm]	Soldering R:Reflow W:Wave	
							Rated voltage x %				
HMK316 BJ473□L-T		100	B X5R ⁺	47000 p	±10, ±20	3.5	200		1.6±0.20	R	
HMK316 BJ683□L-T			B X5R ⁺	68000 p	±10, ±20	3.5	200		1.6±0.20	R	
HMK316 BJ104□L-T			B X5R ⁺	0.1 μ	±10, ±20	3.5	200		1.6±0.20	R	
HMK316 BJ154□L-T			B X5R ⁺	0.15 μ	±10, ±20	3.5	200		1.6±0.20	R	
HMK316 BJ224□L-T			B X5R ⁺	0.22 μ	±10, ±20	3.5	200		1.6±0.20	R	
HMK316 BJ334□L-T			B X5R ⁺	0.33 μ	±10, ±20	3.5	200		1.6±0.20	R	
HMK316 BJ474□L-T			B X5R ⁺	0.47 μ	±10, ±20	3.5	200		1.6±0.20	R	
HMK316 BJ105□L-T			B X5R ⁺	1 μ	±10, ±20	3.5	200		1.6±0.20	R	
QMK316 BJ333□L-T			250	B X5R ⁺	33000 p	±10, ±20	2.5	150		1.6±0.20	R
QMK316 BJ473□L-T				B X5R ⁺	47000 p	±10, ±20	2.5	150		1.6±0.20	R
QMK316 BJ683□L-T				B X5R ⁺	68000 p	±10, ±20	2.5	150		1.6±0.20	R
QMK316 BJ104□L-T				B X5R ⁺	0.1 μ	±10, ±20	2.5	150		1.6±0.20	R
SMK316 BJ153□L-T		630		B X5R ⁺	15000 p	±10, ±20	2.5	120		1.6±0.20	R
SMK316 BJ223□L-T				B X5R ⁺	22000 p	±10, ±20	2.5	120		1.6±0.20	R

▶ This catalog contains the typical specification only due to the limitation of space. When you consider the purchase of our products, please check our specification. For details of each product (characteristics graph, reliability information, precautions for use, and so on), see our Web site (<http://www.ty-top.com/>).

PARTS NUMBER

[Temperature Characteristic BJ : B/X5R] 1.15mm thickness(F)

Part number 1	Part number 2	Rated voltage [V]	Temperature characteristics	Capacitance [F]	Capacitance tolerance [%]	tan δ [%]	HALT	Thickness*3 [mm]	Soldering R:Reflow W:Wave
							Rated voltage x %		
SMK316 BJ102□F-T		630	B X5R ⁺¹	1000 p	±10, ±20	2.5	120	1.15±0.10	R
SMK316 BJ152□F-T			B X5R ⁺¹	1500 p	±10, ±20	2.5	120	1.15±0.10	R
SMK316 BJ222□F-T			B X5R ⁺¹	2200 p	±10, ±20	2.5	120	1.15±0.10	R
SMK316 BJ332□F-T			B X5R ⁺¹	3300 p	±10, ±20	2.5	120	1.15±0.10	R
SMK316 BJ472□F-T			B X5R ⁺¹	4700 p	±10, ±20	2.5	120	1.15±0.10	R
SMK316 BJ682□F-T			B X5R ⁺¹	6800 p	±10, ±20	2.5	120	1.15±0.10	R
SMK316 BJ103□F-T			B X5R ⁺¹	10000 p	±10, ±20	2.5	120	1.15±0.10	R

[Temperature Characteristic B7 : X7R] 1.6mm thickness(L)

Part number 1	Part number 2	Rated voltage [V]	Temperature characteristics	Capacitance [F]	Capacitance tolerance [%]	tan δ [%]	HALT	Thickness*3 [mm]	Soldering R:Reflow W:Wave	
							Rated voltage x %			
HMK316 B7473□L-T		100	X7R	47000 p	±10, ±20	3.5	200	1.6±0.20	R	
HMK316 B7683□L-T			X7R	68000 p	±10, ±20	3.5	200	1.6±0.20	R	
HMK316 B7104□L-T			X7R	0.1 μ	±10, ±20	3.5	200	1.6±0.20	R	
HMK316 B7154□L-T			X7R	0.15 μ	±10, ±20	3.5	200	1.6±0.20	R	
HMK316 B7224□L-T			X7R	0.22 μ	±10, ±20	3.5	200	1.6±0.20	R	
HMK316 B7334□L-T			X7R	0.33 μ	±10, ±20	3.5	200	1.6±0.20	R	
HMK316 B7474□L-T			X7R	0.47 μ	±10, ±20	3.5	200	1.6±0.20	R	
HMK316 B7105□L-T			X7R	1 μ	±10, ±20	3.5	200	1.6±0.20	R	
QMK316 B7333□L-T			250	X7R	33000 p	±10, ±20	2.5	150	1.6±0.20	R
QMK316 B7473□L-T				X7R	47000 p	±10, ±20	2.5	150	1.6±0.20	R
QMK316 B7683□L-T		X7R		68000 p	±10, ±20	2.5	150	1.6±0.20	R	
QMK316 B7104□L-T		X7R		0.1 μ	±10, ±20	2.5	150	1.6±0.20	R	
SMK316 B7153□L-T		630	X7R	15000 p	±10, ±20	2.5	120	1.6±0.20	R	
SMK316 B7223□L-T			X7R	22000 p	±10, ±20	2.5	120	1.6±0.20	R	

[Temperature Characteristic B7 : X7R] 1.15mm thickness(F)

Part number 1	Part number 2	Rated voltage [V]	Temperature characteristics	Capacitance [F]	Capacitance tolerance [%]	tan δ [%]	HALT	Thickness*3 [mm]	Soldering R:Reflow W:Wave
							Rated voltage x %		
SMK316 B7102□F-T		630	X7R	1000 p	±10, ±20	2.5	120	1.15±0.10	R
SMK316 B7152□F-T			X7R	1500 p	±10, ±20	2.5	120	1.15±0.10	R
SMK316 B7222□F-T			X7R	2200 p	±10, ±20	2.5	120	1.15±0.10	R
SMK316 B7332□F-T			X7R	3300 p	±10, ±20	2.5	120	1.15±0.10	R
SMK316 B7472□F-T			X7R	4700 p	±10, ±20	2.5	120	1.15±0.10	R
SMK316 B7682□F-T			X7R	6800 p	±10, ±20	2.5	120	1.15±0.10	R
SMK316 B7103□F-T			X7R	10000 p	±10, ±20	2.5	120	1.15±0.10	R

325TYPE

[Temperature Characteristic BJ : B/X5R] 2.5mm thickness(M)

Part number 1	Part number 2	Rated voltage [V]	Temperature characteristics	Capacitance [F]	Capacitance tolerance [%]	tan δ [%]	HALT	Thickness*3 [mm]	Soldering R:Reflow W:Wave
							Rated voltage x %		
HMK325 BJ225□M-T		100	B X5R ⁺¹	2.2 μ	±10, ±20	3.5	200	2.5±0.20	R

[Temperature Characteristic BJ : B/X5R] 1.9mm thickness(N)

Part number 1	Part number 2	Rated voltage [V]	Temperature characteristics	Capacitance [F]	Capacitance tolerance [%]	tan δ [%]	HALT	Thickness*3 [mm]	Soldering R:Reflow W:Wave	
							Rated voltage x %			
HMK325 BJ154□N-T		100	B X5R ⁺¹	0.15 μ	±10, ±20	3.5	200	1.9±0.20	R	
HMK325 BJ224□N-T			B X5R ⁺¹	0.22 μ	±10, ±20	3.5	200	1.9±0.20	R	
HMK325 BJ334□N-T			B X5R ⁺¹	0.33 μ	±10, ±20	3.5	200	1.9±0.20	R	
HMK325 BJ474□N-T			B X5R ⁺¹	0.47 μ	±10, ±20	3.5	200	1.9±0.20	R	
HMK325 BJ684□N-T			B X5R ⁺¹	0.68 μ	±10, ±20	3.5	200	1.9±0.20	R	
HMK325 BJ105□N-T			B X5R ⁺¹	1 μ	±10, ±20	3.5	200	1.9±0.20	R	
QMK325 BJ473□N-T			250	B X5R ⁺¹	47000 p	±10, ±20	2.5	150	1.9±0.20	R
QMK325 BJ104□N-T				B X5R ⁺¹	0.1 μ	±10, ±20	2.5	150	1.9±0.20	R
QMK325 BJ154□N-T				B X5R ⁺¹	0.15 μ	±10, ±20	2.5	150	1.9±0.20	R
QMK325 BJ224□N-T				B X5R ⁺¹	0.22 μ	±10, ±20	2.5	150	1.9±0.20	R
SMK325 BJ223□N-T		630	B X5R ⁺¹	22000 p	±10, ±20	2.5	120	1.9±0.20	R	
SMK325 BJ333□N-T			B X5R ⁺¹	33000 p	±10, ±20	2.5	120	1.9±0.20	R	
SMK325 BJ473□N-T			B X5R ⁺¹	47000 p	±10, ±20	2.5	120	1.9±0.20	R	

[Temperature Characteristic BJ : B/X5R] 1.15mm thickness(F)

Part number 1	Part number 2	Rated voltage [V]	Temperature characteristics	Capacitance [F]	Capacitance tolerance [%]	tan δ [%]	HALT	Thickness*3 [mm]	Soldering R:Reflow W:Wave
							Rated voltage x %		
HMK325 BJ104□F-T		100	B X5R ⁺¹	0.1 μ	±10, ±20	3.5	200	1.15±0.10	R

[Temperature Characteristic B7 : X7R] 2.5mm thickness(M)

Part number 1	Part number 2	Rated voltage [V]	Temperature characteristics	Capacitance [F]	Capacitance tolerance [%]	tan δ [%]	HALT	Thickness*3 [mm]	Soldering R:Reflow W:Wave
							Rated voltage x %		
HMK325 B7225□M-T		100	X7R	2.2 μ	±10, ±20	3.5	200	2.5±0.20	R

[Temperature Characteristic B7 : X7R] 1.9mm thickness(N)

Part number 1	Part number 2	Rated voltage [V]	Temperature characteristics	Capacitance [F]	Capacitance tolerance [%]	tan δ [%]	HALT	Thickness*3 [mm]	Soldering R:Reflow W:Wave	
							Rated voltage x %			
HMK325 B7154□N-T		100	X7R	0.15 μ	±10, ±20	3.5	200	1.9±0.20	R	
HMK325 B7224□N-T			X7R	0.22 μ	±10, ±20	3.5	200	1.9±0.20	R	
HMK325 B7334□N-T			X7R	0.33 μ	±10, ±20	3.5	200	1.9±0.20	R	
HMK325 B7474□N-T			X7R	0.47 μ	±10, ±20	3.5	200	1.9±0.20	R	
HMK325 B7684□N-T			X7R	0.68 μ	±10, ±20	3.5	200	1.9±0.20	R	
HMK325 B7105□N-T			X7R	1 μ	±10, ±20	3.5	200	1.9±0.20	R	
QMK325 B7473□N-T			250	X7R	47000 p	±10, ±20	2.5	150	1.9±0.20	R
QMK325 B7104□N-T				X7R	0.1 μ	±10, ±20	2.5	150	1.9±0.20	R
QMK325 B7154□N-T				X7R	0.15 μ	±10, ±20	2.5	150	1.9±0.20	R
QMK325 B7224□N-T				X7R	0.22 μ	±10, ±20	2.5	150	1.9±0.20	R

▶ This catalog contains the typical specification only due to the limitation of space. When you consider the purchase of our products, please check our specification. For details of each product (characteristics graph, reliability information, precautions for use, and so on), see our Web site (<http://www.ty-top.com/>).

■ PARTS NUMBER

Part number 1	Part number 2	Rated voltage [V]	Temperature characteristics	Capacitance [F]	Capacitance tolerance [%]	tan δ [%]	HALT	Thickness* ³ [mm]	Soldering R:Reflow W:Wave
							Rated voltage x %		
SMK325 B7223□N-T		630	X7R	22000 p	±10, ±20	2.5	120	1.9±0.20	R
SMK325 B7333□N-T			X7R	33000 p	±10, ±20	2.5	120	1.9±0.20	R
SMK325 B7473□N-T			X7R	47000 p	±10, ±20	2.5	120	1.9±0.20	R

[Temperature Characteristic B7 : X7R] 1.15mm thickness (F)

Part number 1	Part number 2	Rated voltage [V]	Temperature characteristics	Capacitance [F]	Capacitance tolerance [%]	tan δ [%]	HALT	Thickness* ³ [mm]	Soldering R:Reflow W:Wave
							Rated voltage x %		
HMK325 B7104□F-T		100	X7R	0.1 μ	±10, ±20	3.5	200	1.15±0.10	R

● 432TYPE

[Temperature Characteristic BJ : B/X5R] 2.5mm thickness (M)

Part number 1	Part number 2	Rated voltage [V]	Temperature characteristics	Capacitance [F]	Capacitance tolerance [%]	tan δ [%]	HALT	Thickness* ³ [mm]	Soldering R:Reflow W:Wave
							Rated voltage x %		
HMK432 BJ474□M-T		100	B X5R ⁺	0.47 μ	±10, ±20	3.5	200	2.5±0.20	R
HMK432 BJ105□M-T			B X5R ⁺	1 μ	±10, ±20	3.5	200	2.5±0.20	R
HMK432 BJ155□M-T			B X5R ⁺	1.5 μ	±10, ±20	3.5	200	2.5±0.20	R
HMK432 BJ225□M-T		250	B X5R ⁺	2.2 μ	±10, ±20	3.5	200	2.5±0.20	R
QMK432 BJ104□M-T			B X5R ⁺	0.1 μ	±10, ±20	2.5	150	2.5±0.20	R
QMK432 BJ224□M-T			B X5R ⁺	0.22 μ	±10, ±20	2.5	150	2.5±0.20	R
QMK432 BJ334□M-T		630	B X5R ⁺	0.33 μ	±10, ±20	2.5	150	2.5±0.20	R
QMK432 BJ474□M-T			B X5R ⁺	0.47 μ	±10, ±20	2.5	150	2.5±0.20	R
SMK432 BJ473□M-T			B X5R ⁺	47000 p	±10, ±20	2.5	120	2.5±0.20	R
SMK432 BJ683□M-T		630	B X5R ⁺	68000 p	±10, ±20	2.5	120	2.5±0.20	R
SMK432 BJ104□M-T			B X5R ⁺	0.1 μ	±10, ±20	2.5	120	2.5±0.20	R

[Temperature Characteristic B7 : X7R] 2.5mm thickness (M)

Part number 1	Part number 2	Rated voltage [V]	Temperature characteristics	Capacitance [F]	Capacitance tolerance [%]	tan δ [%]	HALT	Thickness* ³ [mm]	Soldering R:Reflow W:Wave
							Rated voltage x %		
HMK432 B7474□M-T		100	X7R	0.47 μ	±10, ±20	3.5	200	2.5±0.20	R
HMK432 B7105□M-T			X7R	1 μ	±10, ±20	3.5	200	2.5±0.20	R
HMK432 B7155□M-T			X7R	1.5 μ	±10, ±20	3.5	200	2.5±0.20	R
HMK432 B7225□M-T		250	X7R	2.2 μ	±10, ±20	3.5	200	2.5±0.20	R
QMK432 B7104□M-T			X7R	0.1 μ	±10, ±20	2.5	150	2.5±0.20	R
QMK432 B7224□M-T			X7R	0.22 μ	±10, ±20	2.5	150	2.5±0.20	R
QMK432 B7334□M-T		630	X7R	0.33 μ	±10, ±20	2.5	150	2.5±0.20	R
QMK432 B7474□M-T			X7R	0.47 μ	±10, ±20	2.5	150	2.5±0.20	R
SMK432 B7473□M-T			X7R	47000 p	±10, ±20	2.5	120	2.5±0.20	R
SMK432 B7683□M-T		630	X7R	68000 p	±10, ±20	2.5	120	2.5±0.20	R
SMK432 B7104□M-T			X7R	0.1 μ	±10, ±20	2.5	120	2.5±0.20	R

LW Reversal Decoupling Capacitor (LWDC™)

● 105TYPE

[Temperature Characteristic BJ : X5R] 0.3mm thickness (P)

Part number 1	Part number 2	Rated voltage [V]	Temperature characteristics	Capacitance [F]	Capacitance tolerance [%]	tan δ [%]	HALT	Thickness* ³ [mm]	Soldering R:Reflow W:Wave
							Rated voltage x %		
TWK105 BJ104MP-F		25	X5R	0.1 μ	±20	5	150	0.3±0.05	R
EWK105 BJ224MP-F		16	X5R	0.22 μ	±20	10	150	0.3±0.05	R
LWK105 BJ474MP-F		10	X5R	0.47 μ	±20	10	150	0.3±0.05	R
JWK105 BJ104MP-F		6.3	X5R ⁺	0.1 μ	±20	5	150	0.3±0.05	R
JWK105 BJ474MP-F			X5R ⁺	0.47 μ	±20	10	150	0.3±0.05	R
JWK105 BJ105MP-F			X5R	1 μ	±20	10	150	0.3±0.05	R
AWK105 BJ224MP-F		4	X5R	0.22 μ	±20	10	150	0.3±0.05	R

[Temperature Characteristic C6 : X6S, C7 : X7S] 0.3mm thickness (P)

Part number 1	Part number 2	Rated voltage [V]	Temperature characteristics	Capacitance [F]	Capacitance tolerance [%]	tan δ [%]	HALT	Thickness* ³ [mm]	Soldering R:Reflow W:Wave
							Rated voltage x %		
EWK105 C6104MP-F		16	X6S	0.1 μ	±20	5	150	0.3±0.05	R
LWK105 C7104MP-F		10	X7S	0.1 μ	±20	5	150	0.3±0.05	R
LWK105 C6224MP-F			X6S	0.22 μ	±20	10	150	0.3±0.05	R
JWK105 C7104MP-F			X7S	0.1 μ	±20	5	150	0.3±0.05	R
JWK105 C7224MP-F		6.3	X7S	0.22 μ	±20	10	150	0.3±0.05	R
JWK105 C6474MP-F			X6S	0.47 μ	±20	10	150	0.3±0.05	R
AWK105 C6224MP-F			X6S	0.22 μ	±20	10	150	0.3±0.05	R
AWK105 C6474MP-F		4	X6S	0.47 μ	±20	10	150	0.3±0.05	R
AWK105 C6105MP-F			X6S	1 μ	±20	10	150	0.3±0.05	R

● 107TYPE

[Temperature Characteristic BJ : X5R] 0.5mm thickness (V)

Part number 1	Part number 2	Rated voltage [V]	Temperature characteristics	Capacitance [F]	Capacitance tolerance [%]	tan δ [%]	HALT	Thickness* ³ [mm]	Soldering R:Reflow W:Wave
							Rated voltage x %		
TWK107 BJ104MV-T		25	X5R ⁺	0.1 μ	±20	5	150	0.5±0.05	R
EWK107 BJ224MV-T		16	X5R ⁺	0.22 μ	±20	5	150	0.5±0.05	R
EWK107 BJ474MV-T			X5R ⁺	0.47 μ	±20	5	150	0.5±0.05	R
LWK107 BJ105MV-T			X5R	1 μ	±20	10	150	0.5±0.05	R
LWK107 BJ225MV-T		10	X5R	2.2 μ	±20	10	150	0.5±0.05	R
JWK107 BJ105MV-T			X5R ⁺	1 μ	±20	10	150	0.5±0.05	R
JWK107 BJ225MV-T			X5R	2.2 μ	±20	10	150	0.5±0.05	R
JWK107 BJ475MV-T		6.3	X5R	4.7 μ	±20	10	150	0.5±0.05	R
AWK107 BJ106MV-T			X5R	10 μ	±20	10	150	0.5±0.05	R

▶ This catalog contains the typical specification only due to the limitation of space. When you consider the purchase of our products, please check our specification. For details of each product (characteristics graph, reliability information, precautions for use, and so on), see our Web site (<http://www.ty-top.com/>).

Multilayer Ceramic Capacitors

PACKAGING

① Minimum Quantity

● Taped package

Type(EIA)	Thickness		Standard quantity [pcs]	
	mm	code	Paper tape	Embossed tape
□MK042(01005)	0.2	C, D	—	40000
□MK063(0201)	0.3	P, T	15000	
□WK105(0204) ※	0.3	P	10000	
□MK105(0402)	0.2	C	20000	—
	0.3	P	15000	
	0.5	V	10000	
□VK105(0402) ※	0.5	W	4000	
□MK107(0603)	0.45	K	—	4000
□WK107(0306) ※	0.5	V	—	4000
□MR107(0603)	0.8	A	—	—
□MK212(0805)	0.45	K	4000	—
□WK212(0508) ※	0.85	D	—	3000
□MR212(0805)	1.25	G	—	—
□MK316(1206) □MR316(1206)	0.85	D	4000	—
	1.15	F	—	3000
	1.25	G	—	—
□MK325(1210) □MR325(1210)	1.6	L	—	2000
	0.85	D	—	—
	1.15	F	—	—
	1.9	N	—	—
□MK432(1812)	2.0max.	Y	—	500(T), 1000(P)
	2.5	M	—	500

Note : ※ LW Reverse type.

② Taping material

※No bottom tape for pressed carrier tape

● Card board carrier tape

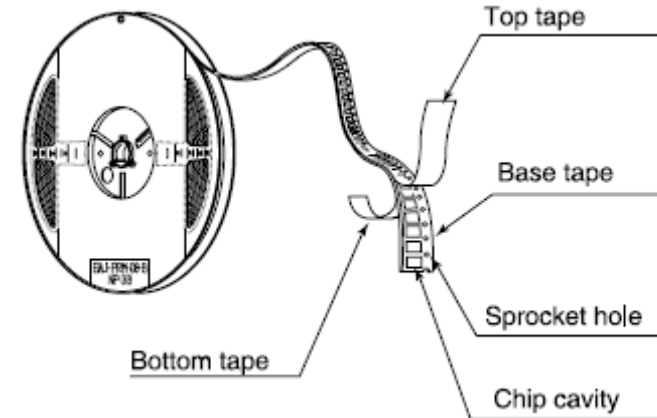

● Embossed tape

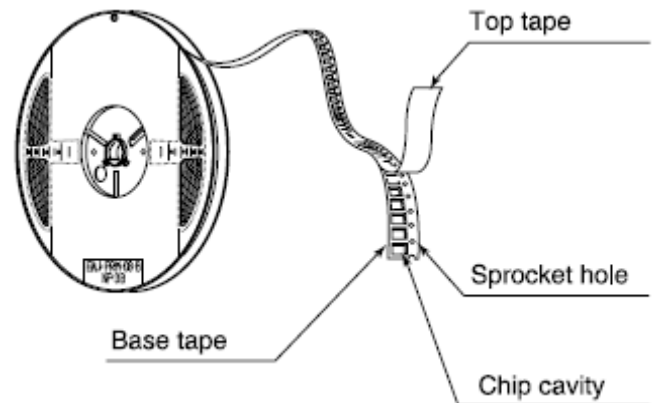

Chip filled

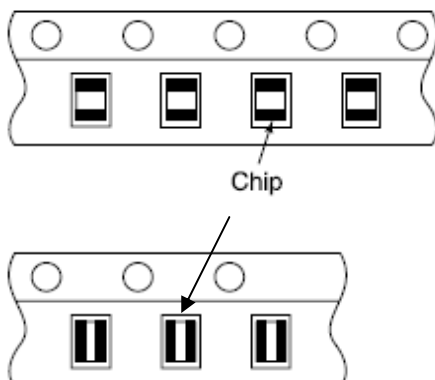

▶ This catalog contains the typical specification only due to the limitation of space. When you consider the purchase of our products, please check our specification. For details of each product (characteristics graph, reliability information, precautions for use, and so on), see our Web site (<http://www.ty-top.com/>).

③ Representative taping dimensions

- Paper Tape (8mm wide)
- Pressed carrier tape (2mm pitch)

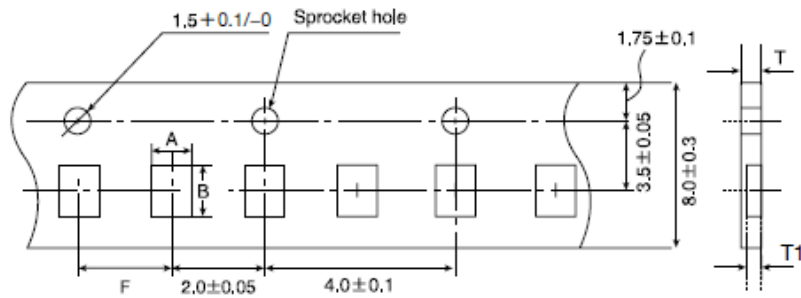

Type(EIA)	Chip Cavity		Insertion Pitch F	Tape Thickness	
	A	B		T	T1
□MK063(0201)	0.37	0.67	2.0±0.05	0.45max.	0.42max.
□WK105(0204) ※	0.65	1.15		0.4max.	0.3max.
□MK105(0402) (*1 C)				0.45max.	0.42max.
□MK105(0402) (*1 P)					

Note *1 Thickness, C: 0.2mm ,P: 0.3mm. ※ LW Reverse type.

Unit: mm

- Punched carrier tape (2mm pitch)

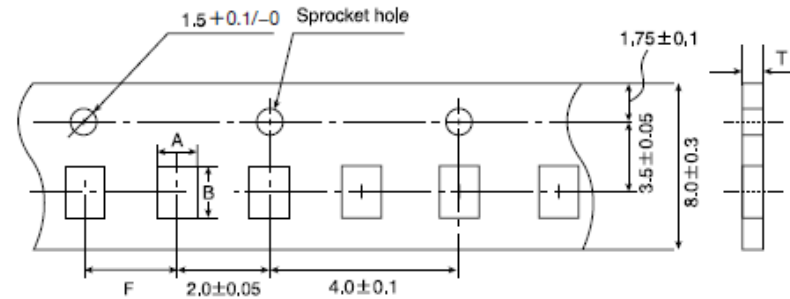

Type(EIA)	Chip Cavity		Insertion Pitch F	Tape Thickness
	A	B		T
□MK105 (0402)	0.65	1.15	2.0±0.05	0.8max.
□VK105 (0402)				

Unit: mm

- Punched carrier tape (4mm pitch)

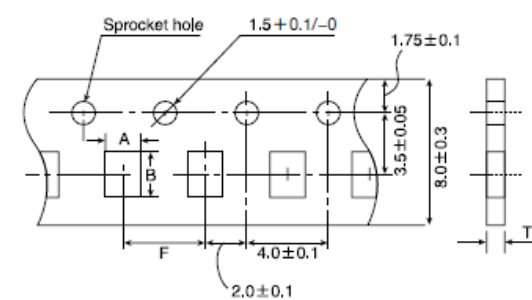

Type(EIA)	Chip Cavity		Insertion Pitch F	Tape Thickness
	A	B		T
□MK107(0603)	1.0	1.8	4.0±0.1	1.1max.
□WK107(0306) ※				1.1max.
□MR107(0603)				
□MK212(0805)	1.65	2.4		1.1max.
□WK212(0508) ※				
□MK316(1206)	2.0	3.6		

Note: Taping size might be different depending on the size of the product. ※ LW Reverse type.

Unit: mm

● Embossed tape (4mm wide)

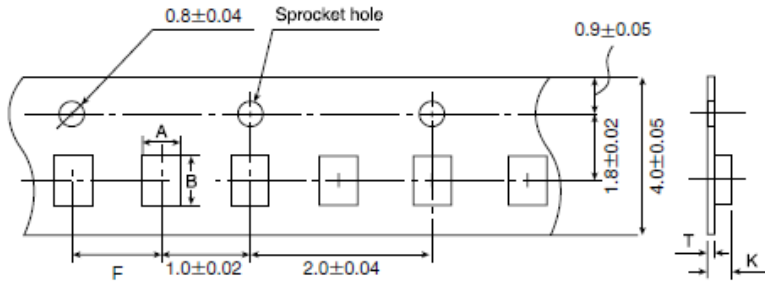

Type(EIA)	Chip Cavity		Insertion Pitch	Tape Thickness	
	A	B		K	T
□MK042(01005)	0.23	0.43	1.0±0.02	0.5max.	0.25max.

Unit: mm

● Embossed tape (8mm wide)

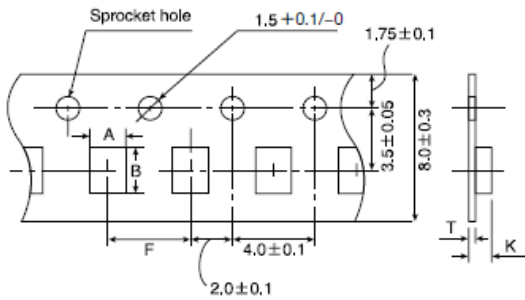

Type(EIA)	Chip Cavity		Insertion Pitch	Tape Thickness	
	A	B		K	T
□WK107(0306) ※	1.0	1.8	4.0±0.1	1.3max.	0.25±0.1
□MK212(0805)	1.65	2.4		3.4max.	0.6max.
□MR212(0805)					
□MK316(1206)	2.0	3.6			
□MR316(1206)					
□MK325(1210)	2.8	3.6			
□MR325(1210)					

Note: ※ LW Reverse type.

Unit: mm

● Embossed tape (12mm wide)

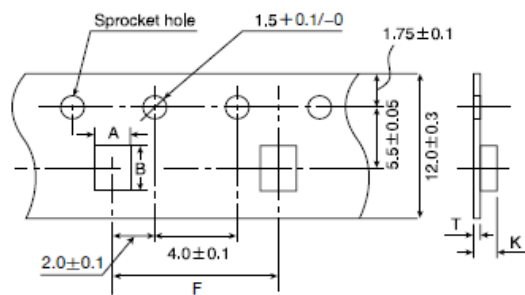

Type(EIA)	Chip Cavity		Insertion Pitch	Tape Thickness	
	A	B		K	T
□MK432(1812)	3.7	4.9	8.0±0.1	4.0max.	0.6max.

Unit: mm

④Trailer and Leader

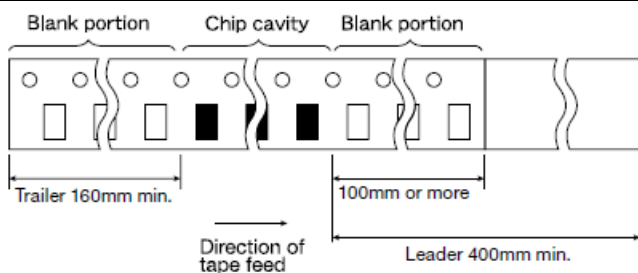

▶ This catalog contains the typical specification only due to the limitation of space. When you consider the purchase of our products, please check our specification. For details of each product (characteristics graph, reliability information, precautions for use, and so on), see our Web site (<http://www.ty-top.com/>).

⑤ Reel size

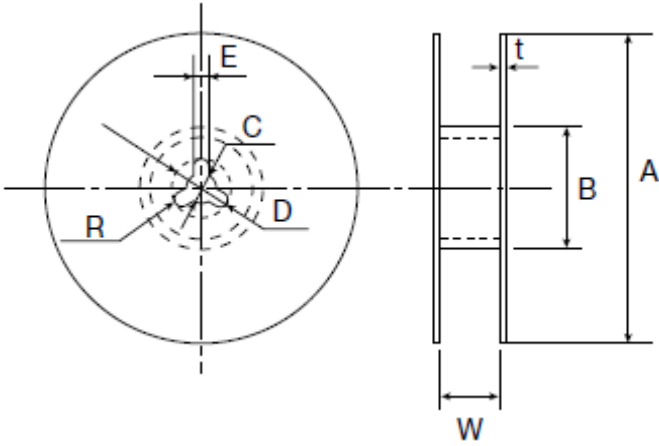

A	B	C	D	E	R
$\phi 178 \pm 2.0$	$\phi 50 \text{min.}$	$\phi 13.0 \pm 0.2$	$\phi 21.0 \pm 0.8$	2.0 ± 0.5	1.0

	T	W
4mm wide tape	1.5max.	5 ± 1.0
8mm wide tape	2.5max.	10 ± 1.5
12mm wide tape	2.5max.	14 ± 1.5

Unit : mm

⑥ Top Tape Strength

The top tape requires a peel-off force of 0.1 to 0.7N in the direction of the arrow as illustrated below.

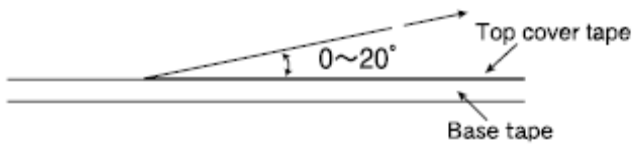

⑦ Bulk Cassette

The exchange of individual specification is necessary.
Please contact Taiyo Yuden sales channels.

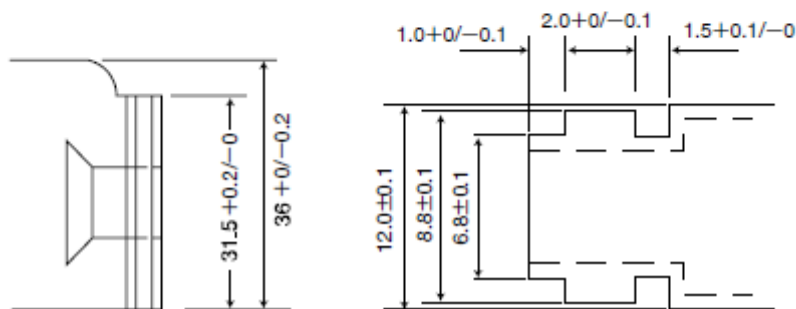
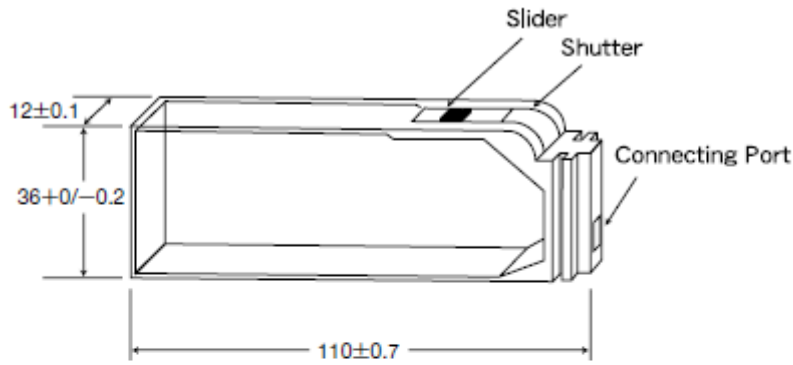

Unit : mm

▶ This catalog contains the typical specification only due to the limitation of space. When you consider the purchase of our products, please check our specification.
For details of each product (characteristics graph, reliability information, precautions for use, and so on), see our Web site (<http://www.ty-top.com/>).

Medium-High Voltage Multilayer Ceramic Capacitor

RELIABILITY DATA

1. Operating Temperature Range													
Specified Value	X7R, X7S : -55 to +125°C X5 : -55 to +85°C B : -25 to +85°C												
2. Storage Temperature Range													
Specified Value	X7R, X7S : -55 to +125°C X5R : -55 to +85°C B : -25 to +85°C												
3. Rated Voltage													
Specified Value	100VDC(HMK), 250VDC(QMK), 630VDC(SMK)												
4. Withstanding Voltage (Between terminals)													
Specified Value	No breakdown or damage												
Test Methods and Remarks	Applied voltage : Rated voltage × 2.5 (HMK), Rated voltage × 2 (QMK), Rated voltage × 1.2 (SMK) Duration : 1 to 5sec. Charge/discharge current : 50mA max.												
5. Insulation Resistance													
Specified Value	100MΩ μF or 10GΩ, whichever is smaller.												
Test Methods and Remarks	Applied voltage : Rated voltage (HMK, QMK), 500V (SMK) Duration : 60±5sec. Charge/discharge current : 50mA max.												
6. Capacitance (Tolerance)													
Specified Value	±10%, ±20%												
Test Methods and Remarks	Masuring frequency : 1kHz ± 10% Measuring voltage : 1 ± 0.2Vrms Bias application : None												
7. Dissipation Factor													
Specified Value	3.5%max (HMK) 2.5%max (QMK, SMK)												
Test Methods and Remarks	Measuring frequency : 1kHz ± 10% Measuring voltage : 1 ± 0.2Vrms Bias application : None												
8. Temperature Characteristic of Capacitance													
Specified Value	B : ±10% (-25 to +85°C) X5R : ±15% (-55 to +85°C) X7R : ±15% (-55 to +125°C) X7S : ±22% (-55 to +125°C)												
Test Methods and Remarks	Capacitance value at each step shall be measured in thermal equilibrium, and the temperature characteristic shall be calculated from the following equation. <table border="1" style="margin-left: 20px;"> <thead> <tr> <th>Step</th> <th>B</th> <th>X5R, X7R, X7S</th> </tr> </thead> <tbody> <tr> <td>1</td> <td colspan="2">Minimum operating temperature</td> </tr> <tr> <td>2</td> <td>20°C</td> <td>25°C</td> </tr> <tr> <td>3</td> <td colspan="2">Maximum operating temperature</td> </tr> </tbody> </table> $\frac{(C - C_2)}{C_2} \times 100(\%)$ <p>C : Capacitance value in Step 1 or Step 3 C2 : Capacitance value in Step 2</p>	Step	B	X5R, X7R, X7S	1	Minimum operating temperature		2	20°C	25°C	3	Maximum operating temperature	
Step	B	X5R, X7R, X7S											
1	Minimum operating temperature												
2	20°C	25°C											
3	Maximum operating temperature												

▶ This catalog contains the typical specification only due to the limitation of space. When you consider the purchase of our products, please check our specification. For details of each product (characteristics graph, reliability information, precautions for use, and so on), see our Web site (<http://www.ty-top.com/>).

9. Deflection

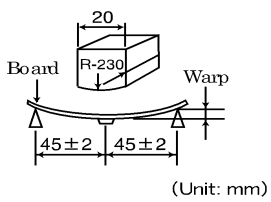
Specified Value	Appearance : No abnormality Capacitance change : Within $\pm 10\%$
Test Methods and Remarks	<p>Warp : 1mm Duration : 10sec. Test board : Glass epoxy-resin substrate Thicknss : 1.6mm</p>  <p>Capacitance measurement shall be conducted with the board bent.</p>

10. Adhesive Strength of Terminal Electrodes

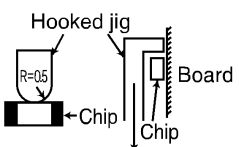
Specified Value	No terminal separation or its indication.
Test Methods and Remarks	<p>Applied force : 5N Duration : 30 ± 5sec.</p> 

11. Solderability

Specified Value	At least 95% of terminal electrode is covered by new solder		
Test Methods and Remarks		Eutectic solder	Lead-free solder
	Solder type	H60A or H63A	Sn-3.0Ag-0.5Cu
	Solder temperature	$230 \pm 5^\circ\text{C}$	$245 \pm 3^\circ\text{C}$
	Duration	4 ± 1 sec.	

12. Resistance to Soldering

Specified Value	Appearance : No abnormality Capacitance change : Within $\pm 15\%$ (HMK), $\pm 10\%$ (QMK, SMK) Dissipation factor : Initial value Insulation resistance : Initial value Withstanding voltage (between terminals) : No abnormality
Test Methods and Remarks	<p>Preconditioning : Thermal treatment (at 150°C for 1hr) Note1 Solder temperature : $270 \pm 5^\circ\text{C}$ Duration : 3 ± 0.5sec. Prehating conditions : 80 to 100°C, 2 to 5 min. 150 to 200°C, 2 to 5min. Recovery : 24 ± 2hrs under the stadard condition Note3</p>

13. Temperature Cycle (Thermal Shock)

Specified Value	Appearance : No abnormality Capacitance change : Within $\pm 15\%$ (HMK), $\pm 7.5\%$ (QMK, SMK) Dissipation factor : Initial value Insulation resistance : Initial value															
Test Methods and Remarks	<p>Preconditioning : Thermal treatment (at 150°C for 1hr) Note1 Conditions for 1 cycle</p> <table border="1" data-bbox="287 1523 1133 1680"> <thead> <tr> <th>Step</th> <th>temperature ($^\circ\text{C}$)</th> <th>Time (min.)</th> </tr> </thead> <tbody> <tr> <td>1</td> <td>Minimum operating temperature</td> <td>30 ± 3min.</td> </tr> <tr> <td>2</td> <td>Normal temperature</td> <td>2 to 3min.</td> </tr> <tr> <td>3</td> <td>Maximum operating temperature</td> <td>30 ± 3min.</td> </tr> <tr> <td>4</td> <td>Normal temperature</td> <td>2 to 3min.</td> </tr> </tbody> </table> <p>Number of cycles : 5 times Recovery : 24 ± 2hrs under the standard condition Note3</p>	Step	temperature ($^\circ\text{C}$)	Time (min.)	1	Minimum operating temperature	30 ± 3 min.	2	Normal temperature	2 to 3min.	3	Maximum operating temperature	30 ± 3 min.	4	Normal temperature	2 to 3min.
Step	temperature ($^\circ\text{C}$)	Time (min.)														
1	Minimum operating temperature	30 ± 3 min.														
2	Normal temperature	2 to 3min.														
3	Maximum operating temperature	30 ± 3 min.														
4	Normal temperature	2 to 3min.														

▶ This catalog contains the typical specification only due to the limitation of space. When you consider the purchase of our products, please check our specification. For details of each product (characteristics graph, reliability information, precautions for use, and so on), see our Web site (<http://www.ty-top.com/>).

14. Humidity (Steady state)	
Specified Value	Appearance : No abnormality Capacitance change : Within $\pm 15\%$ Dissipation factor : 7%max (HMK), 5%max (QMK, SMK). Insulation resistance : 25M Ω μ F or 1000M Ω , whichever is smaller.
Test Methods and Remarks	Preconditioning : Thermal treatment (at 150°C for 1hr) Note1 Temperature : 40 \pm 2°C Humidity : 90 to 95%RH Duration : 500 +24/−0 hrs Recovery : 24 \pm 2hrs under the standard condition Note3
15. Humidity Loading	
Specified Value	Appearance : No abnormality Capacitance change : Within $\pm 15\%$ Dissipation factor : 7%max (HMK), 5%max (QMK, SMK). Insulation resistance : 10M Ω μ F or 500M Ω , whichever is smaller.
Test Methods and Remarks	According to JIS 5102 clause 9.9. Preconditioning : Voltage treatment Note2 Temperature : 40 \pm 2°C Humidity : 90 to 95%RH Applied voltage : Rated voltage Charge/discharge current : 50mA max. Duration : 500 +24/−0 hrs Recovery : 24 \pm 2hrs under the standard condition Note3
16. High Temperature Loading	
Specified Value	Appearance : No abnormality Capacitance change : Within $\pm 15\%$ Dissipation factor : 7%max (HMK), 5%max (QMK, SMK). Insulation resistance : 50M Ω μ F or 1000M Ω , whichever is smaller.
Test Methods and Remarks	According to JIS 5102 clause 9.10. Preconditioning : Voltage treatment Note2 Temperature : Maximum operating temperature Applied voltage : Rated voltage \times 2 (HMK) Rated voltage \times 1.5 (QMK) Rated voltage \times 1.2 (SMK) Charge/discharge current : 50mA max. Duration : 1000 +24/−0 hrs Recovery : 24 \pm 2hrs under the standard condition Note3
Note1 Thermal treatment : Initial value shall be measured after test sample is heat-treated at 150+0/−10°C for an hour and kept at room temperature for 24 \pm 2hours.	
Note2 Voltage treatment : Initial value shall be measured after test sample is voltage-treated for an hour at both the temperature and voltage specified in the test conditions, and kept at room temperature for 24 \pm 2hours.	
Note3 Standard condition : Temperature: 5 to 35°C, Relative humidity: 45 to 85 % RH, Air pressure: 86 to 106kPa When there are questions concerning measurement results, in order to provide correlation data, the test shall be conducted under the following condition. Temperature: 20 \pm 2°C, Relative humidity: 60 to 70 % RH, Air pressure: 86 to 106kPa Unless otherwise specified, all the tests are conducted under the "standard condition".	

Precautions on the use of Multilayer Ceramic Capacitors

PRECAUTIONS

1. Circuit Design

- Precautions**
- ◆ Verification of operating environment, electrical rating and performance
 1. A malfunction of equipment in fields such as medical, aerospace, nuclear control, etc. may cause serious harm to human life or have severe social ramifications. Therefore, any capacitors to be used in such equipment may require higher safety and reliability, and shall be clearly differentiated from them used in general purpose applications.
 - ◆ Operating Voltage (Verification of Rated voltage)
 1. The operating voltage for capacitors must always be their rated voltage or less. If an AC voltage is loaded on a DC voltage, the sum of the two peak voltages shall be the rated voltage or less. For a circuit where an AC or a pulse voltage may be used, the sum of their peak voltages shall also be the rated voltage or less.
 2. Even if an applied voltage is the rated voltage or less reliability of capacitors may be deteriorated in case that either a high frequency AC voltage or a pulse voltage having rapid rise time is used in a circuit.

2. PCB Design

- Precautions**
- ◆ Pattern configurations (Design of Land-patterns)
 1. When capacitors are mounted on PCBs, the amount of solder used (size of fillet) can directly affect the capacitor performance. Therefore, the following items must be carefully considered in the design of land patterns:
 - (1) Excessive solder applied can cause mechanical stresses which lead to chip breaking or cracking. Therefore, please consider appropriate land-patterns for proper amount of solder.
 - (2) When more than one component are jointly soldered onto the same land, each component's soldering point shall be separated by solder-resist.
 - ◆ Pattern configurations (Capacitor layout on PCBs)

After capacitors are mounted on boards, they can be subjected to mechanical stresses in subsequent manufacturing processes (PCB cutting, board inspection, mounting of additional parts, assembly into the chassis, wave soldering of the boards, etc.). For this reason, land pattern configurations and positions of capacitors shall be carefully considered to minimize stresses.

- Technical considerations**
- ◆ Pattern configurations (Design of Land-patterns)

The following diagrams and tables show some examples of recommended land patterns to prevent excessive solder amounts.

 - (1) Recommended land dimensions for typical chip capacitors
 - Multilayer Ceramic Capacitors : Recommended land dimensions (unit: mm)
 - Wave-soldering

Type		107	212	316	325
Size	L	1.6	2.0	3.2	3.2
	W	0.8	1.25	1.6	2.5
A		0.8 to 1.0	1.0 to 1.4	1.8 to 2.5	1.8 to 2.5
B		0.5 to 0.8	0.8 to 1.5	0.8 to 1.7	0.8 to 1.7
C		0.6 to 0.8	0.9 to 1.2	1.2 to 1.6	1.8 to 2.5

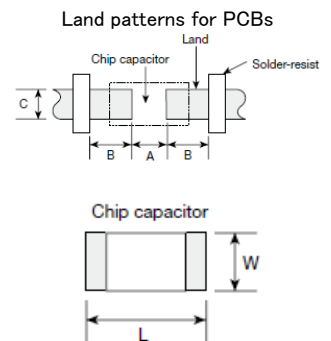

Reflow-soldering

Type	042	063	105	107	212	316	325	432
Size	L	0.4	0.6	1.0	1.6	2.0	3.2	4.5
	W	0.2	0.3	0.5	0.8	1.25	1.6	3.2
A		0.15 to 0.25	0.20 to 0.30	0.45 to 0.55	0.8 to 1.0	0.8 to 1.2	1.8 to 2.5	1.8 to 2.5
B		0.15 to 0.20	0.20 to 0.30	0.40 to 0.50	0.6 to 0.8	0.8 to 1.2	1.0 to 1.5	1.0 to 1.5
C		0.15 to 0.30	0.25 to 0.40	0.45 to 0.55	0.6 to 0.8	0.9 to 1.6	1.2 to 2.0	1.8 to 3.2

Note: Recommended land size might be different according to the allowance of the size of the product.

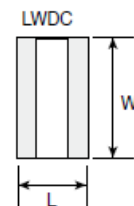

- LWDC: Recommended land dimensions for reflow-soldering (unit: mm)

Type		105	107	212
Size	L	0.52	0.8	1.25
	W	1.0	1.6	2.0
A		0.18 to 0.22	0.25 to 0.3	0.5 to 0.7
B		0.2 to 0.25	0.3 to 0.4	0.4 to 0.5
C		0.9 to 1.1	1.5 to 1.7	1.9 to 2.1



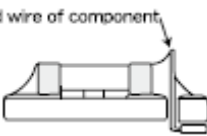
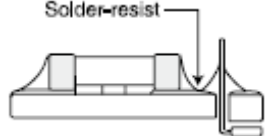

▶ This catalog contains the typical specification only due to the limitation of space. When you consider the purchase of our products, please check our specification. For details of each product (characteristics graph, reliability information, precautions for use, and so on), see our Web site (<http://www.ty-top.com/>).

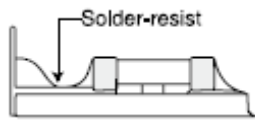
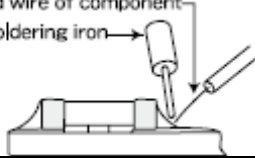
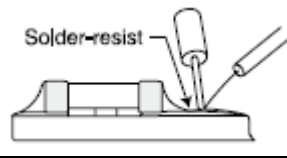
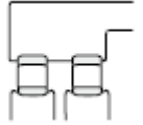
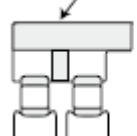
(2) Examples of good and bad solder application

Items	Not recommended	Recommended
Mixed mounting of SMD and leaded components		
Component placement close to the chassis		
Hand-soldering of leaded Components near mounted components		
Horizontal component placement		

◆ Pattern configurations (Capacitor layout on PCBs)

1-1. The following is examples of good and bad capacitor layouts ; capacitors shall be located to minimize any possible mechanical stresses from board warp or deflection.

Items	Not recommended	Recommended
Deflection of board		 Place the product at a right angle to the direction of the anticipated mechanical stress.

1-2. The amount of mechanical stresses given will vary depending on capacitor layout. Please refer to diagram below.

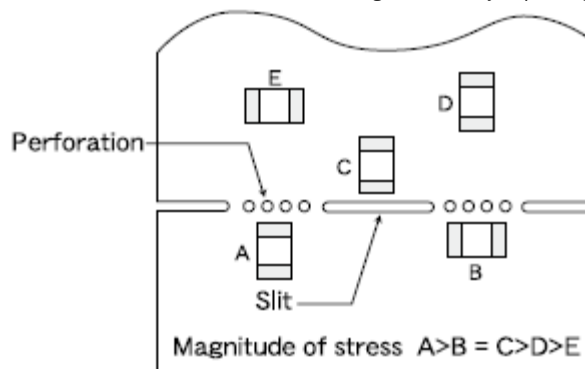

1-3. When PCB is split, the amount of mechanical stress on the capacitors can vary according to the method used. The following methods are listed in order from least stressful to most stressful: push-back, slit, V-grooving, and perforation. Thus, please consider the PCB, split methods as well as chip location.

3. Mounting

Precautions	<p>◆ Adjustment of mounting machine</p> <ol style="list-style-type: none"> When capacitors are mounted on PCB, excessive impact load shall not be imposed on them. Maintenance and inspection of mounting machines shall be conducted periodically. <p>◆ Selection of Adhesives</p> <ol style="list-style-type: none"> When chips are attached on PCBs with adhesives prior to soldering, it may cause capacitor characteristics degradation unless the following factors are appropriately checked : size of land patterns, type of adhesive, amount applied, hardening temperature and hardening period. Therefore, please contact us for further information.
Technical considerations	<p>◆ Adjustment of mounting machine</p> <ol style="list-style-type: none"> When the bottom dead center of a pick-up nozzle is too low, excessive force is imposed on capacitors and causes damages. To avoid this, the following points shall be considerable. <ol style="list-style-type: none"> The bottom dead center of the pick-up nozzle shall be adjusted to the surface level of PCB without the board deflection. The pressure of nozzle shall be adjusted between 1 and 3 N static loads. To reduce the amount of deflection of the board caused by impact of the pick-up nozzle, supporting pins or back-up pins shall be used on the other side of the PCB. The following diagrams show some typical examples of good and bad pick-up nozzle placement:

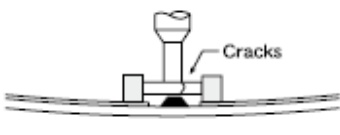
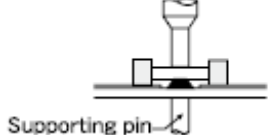
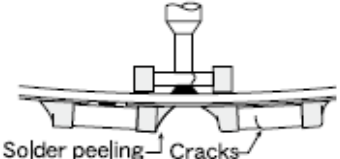
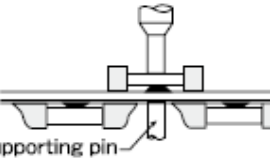
Items	Not recommended	Recommended
Single-sided mounting		
Double-sided mounting		

2. As the alignment pin is worn out, adjustment of the nozzle height can cause chipping or cracking of capacitors because of mechanical impact on the capacitors.
To avoid this, the monitoring of the width between the alignment pins in the stopped position, maintenance, check and replacement of the pin shall be conducted periodically.

◆ Selection of Adhesives

Some adhesives may cause IR deterioration. The different shrinkage percentage of between the adhesive and the capacitors may result in stresses on the capacitors and lead to cracking. Moreover, too little or too much adhesive applied to the board may adversely affect components. Therefore, the following precautions shall be noted in the application of adhesives.

(1) Required adhesive characteristics

- The adhesive shall be strong enough to hold parts on the board during the mounting & solder process.
- The adhesive shall have sufficient strength at high temperatures.
- The adhesive shall have good coating and thickness consistency.
- The adhesive shall be used during its prescribed shelf life.
- The adhesive shall harden rapidly.
- The adhesive shall have corrosion resistance.
- The adhesive shall have excellent insulation characteristics.
- The adhesive shall have no emission of toxic gasses and no effect on the human body.

(2) The recommended amount of adhesives is as follows;

[Recommended condition]

Figure	212/316 case sizes as examples
a	0.3mm min
b	100 to 120 μ m
c	Adhesives shall not contact land

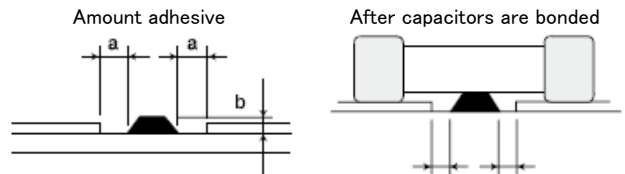

4. Soldering

◆ Selection of Flux

Since flux may have a significant effect on the performance of capacitors, it is necessary to verify the following conditions prior to use;

Precautions

- Flux used shall be less than or equal to 0.1 wt% (in Cl equivalent) of halogenated content. Flux having a strong acidity content shall not be applied.
- When shall capacitors are soldered on boards, the amount of flux applied shall be controlled at the optimum level.
- When water-soluble flux is used, special care shall be taken to properly clean the boards.

◆ Soldering

Temperature, time, amount of solder, etc. shall be set in accordance with their recommended conditions.

Sn-Zn solder paste can adversely affect MLCC reliability.

Please contact us prior to usage of Sn-Zn solder.

Technical considerations

◆ Selection of Flux

1-1. When too much halogenated substance (Chlorine, etc.) content is used to activate flux, or highly acidic flux is used, it may lead to corrosion of terminal electrodes or degradation of insulation resistance on the surfaces of the capacitors.

1-2. Flux is used to increase solderability in wave soldering. However if too much flux is applied, a large amount of flux gas may be emitted and may adversely affect the solderability. To minimize the amount of flux applied, it is recommended to use a flux-bubbling system.

1-3. Since the residue of water-soluble flux is easily dissolved in moisture in the air, the residues on the surfaces of capacitors in high humidity conditions may cause a degradation of insulation resistance and reliability of the capacitors. Therefore, the cleaning methods and the capability of the machines used shall also be considered carefully when water-soluble flux is used.

◆ Soldering

- Ceramic chip capacitors are susceptible to thermal shock when exposed to rapid or concentrated heating or rapid cooling.
- Therefore, the soldering must be conducted with great care so as to prevent malfunction of the components due to excessive thermal shock.
- Preheating : Capacitors shall be preheated sufficiently, and the temperature difference between the capacitors and solder shall be within 100 to 130°C.
- Cooling : The temperature difference between the capacitors and cleaning process shall not be greater than 100°C.

▶ This catalog contains the typical specification only due to the limitation of space. When you consider the purchase of our products, please check our specification.
For details of each product (characteristics graph, reliability information, precautions for use, and so on), see our Web site (<http://www.ty-top.com/>).

[Reflow soldering]

【Recommended conditions for eutectic soldering】

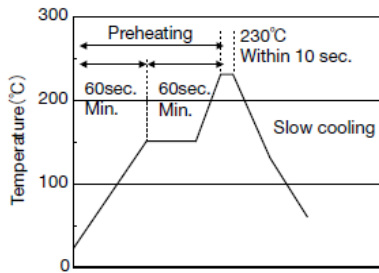

【Recommended condition for Pb-free soldering】

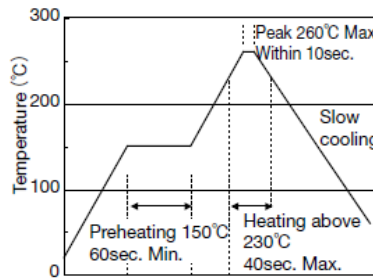

Caution

- ① The ideal condition is to have solder mass (fillet) controlled to $1/2$ to $1/3$ of the thickness of a capacitor.
- ② Because excessive dwell times can adversely affect solderability, soldering duration shall be kept as close to recommended times as possible.

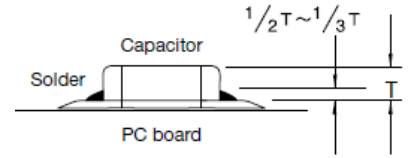

[Wave soldering]

【Recommended conditions for eutectic soldering】

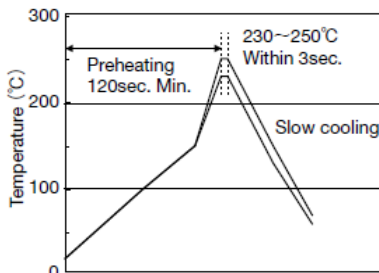

【Recommended condition for Pb-free soldering】

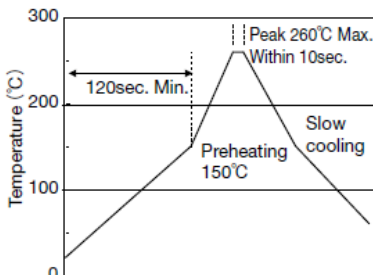

Caution

- ① Wave soldering must not be applied to capacitors designated as for reflow soldering only.

[Hand soldering]

【Recommended conditions for eutectic soldering】

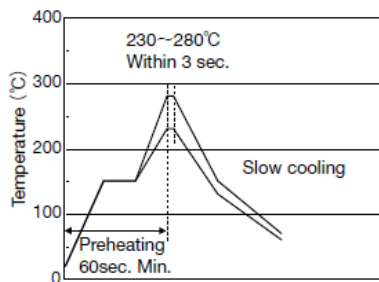

【Recommended condition for Pb-free soldering】

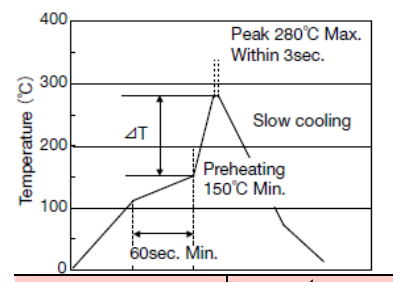
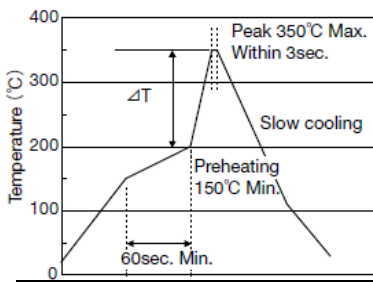

Caution

- ① Use a 50W soldering iron with a maximum tip diameter of 1.0 mm.
- ② The soldering iron shall not directly touch capacitors.

5. Cleaning

Precautions	<p>◆Cleaning conditions</p> <ol style="list-style-type: none"> 1. When PCBs are cleaned after capacitors mounting, please select the appropriate cleaning solution in accordance with the intended use of the cleaning. (e.g. to remove soldering flux or other materials from the production process.) 2. Cleaning condition shall be determined after it is verified by using actual cleaning machine that the cleaning process does not affect capacitor's characteristics.
Technical considerations	<ol style="list-style-type: none"> 1. The use of inappropriate cleaning solutions can cause foreign substances such as flux residue to adhere to capacitors or deteriorate their outer coating, resulting in a degradation of the capacitor's electrical properties (especially insulation resistance). 2. Inappropriate cleaning conditions (insufficient or excessive cleaning) may adversely affect the performance of the capacitors. In the case of ultrasonic cleaning, too much power output can cause excessive vibration of PCBs which may lead to the cracking of capacitors or the soldered portion, or decrease the terminal electrodes' strength. Therefore, the following conditions shall be carefully checked: Ultrasonic output : 20 W/l or less Ultrasonic frequency : 40 kHz or less Ultrasonic washing period : 5 min. or less

▶ This catalog contains the typical specification only due to the limitation of space. When you consider the purchase of our products, please check our specification. For details of each product (characteristics graph, reliability information, precautions for use, and so on), see our Web site (<http://www.ty-top.com/>).

6. Resin coating and mold	
Precautions	<p>1. With some type of resins, decomposition gas or chemical reaction vapor may remain inside the resin during the hardening period or while left under normal storage conditions resulting in the deterioration of the capacitor's performance.</p> <p>2. When a resin's hardening temperature is higher than capacitor's operating temperature, the stresses generated by the excessive heat may lead to damage or destruction of capacitors. The use of such resins, molding materials etc. is not recommended.</p>
7. Handling	
Precautions	<p>◆ Splitting of PCB</p> <p>1. When PCBs are split after components mounting, care shall be taken so as not to give any stresses of deflection or twisting to the board.</p> <p>2. Board separation shall not be done manually, but by using the appropriate devices.</p> <p>◆ Mechanical considerations</p> <p>Be careful not to subject capacitors to excessive mechanical shocks.</p> <p>(1) If ceramic capacitors are dropped onto a floor or a hard surface, they shall not be used.</p> <p>(2) Please be careful that the mounted components do not come in contact with or bump against other boards or components.</p>
8. Storage conditions	
Precautions	<p>◆ Storage</p> <p>1. To maintain the solderability of terminal electrodes and to keep packaging materials in good condition, care must be taken to control temperature and humidity in the storage area. Humidity should especially be kept as low as possible.</p> <p>• Recommended conditions</p> <p style="padding-left: 20px;">Ambient temperature : Below 30°C</p> <p style="padding-left: 20px;">Humidity : Below 70% RH</p> <p style="padding-left: 20px;">The ambient temperature must be kept below 40°C. Even under ideal storage conditions, solderability of capacitor is deteriorated as time passes, so capacitors shall be used within 6 months from the time of delivery.</p> <p>• Ceramic chip capacitors shall be kept where no chlorine or sulfur exists in the air.</p> <p>2. The capacitance values of high dielectric constant capacitors will gradually decrease with the passage of time, so care shall be taken to design circuits. Even if capacitance value decreases as time passes, it will get back to the initial value by a heat treatment at 150°C for 1 hour.</p>
Technical considerations	<p>If capacitors are stored in a high temperature and humidity environment, it might rapidly cause poor solderability due to terminal oxidation and quality loss of taping/packaging materials. For this reason, capacitors shall be used within 6 months from the time of delivery. If exceeding the above period, please check solderability before using the capacitors.</p>
<p>※RCR-2335B (Safety Application Guide for fixed ceramic capacitors for use in electronic equipment) is published by JEITA. Please check the guide regarding precautions for deflection test, soldering by spot heat, and so on.</p>	