

Applications

- Machines / Robotics
- Process control
- Instrumentation
- Railways

Standards



Description

- Plastic low cost connector
- A retention plate system allowing insertion/extraction of the contacts without the need for tooling
- A high sealing level up to IP68
- Facilities to use trade backshells with the electrical thread adaptor (PG)

Characteristics

Mechanical

- Monobloc shell and insulator in thermoplastic* material self-extinguishing to UL 94 VO
- 180° screw coupling with positive audible safety latch
- Scoop proof
- Copper alloy contacts, machined or stamped and formed :
 - plating : gold flash on active part
- Mechanical endurance :
 - connector : 250 cycles mating / unmating
 - retention plate : 50 cycles mating / unmating
- Retention force :
 - Ø 1 mm → 70 N
 - Ø 1.6 mm → 90 N
- Vibration :
 - frequency range : 10-2000 Hz, 20 g
 - 10 cycles in accordance with CEI 68-2-6

* Composite version are under development. Consult FCI.

Electrical

- Withstand voltage : 1500 Vrms min or in accordance with DIN 57110b
- Contact resistance < 10 mΩ
- Current rating per contact :
 - machined contacts :
 - Ø 1 mm (7 A), Ø 1.6 mm (13 A)
 - stamped and formed contacts :
 - Ø 1 mm (5 A), Ø 1.6 mm (10 A)

Climatic

- Working temperature :
 - 40°C to +125°C
- Sealing
 - examples :
 - connector + sealing gland : IP68
 - connector + grommet : IP67
- Resistance to salt spray :
 - 48 h min
 - > 1000 h (sealed mated connectors)

Resistance to fluids

- oil,
- petrol, fuel,
- lubricants
- other fluids : consult FCI

Retention plate principle

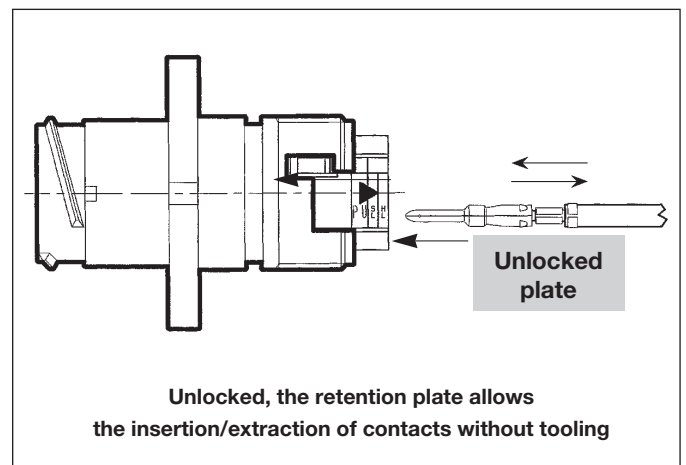
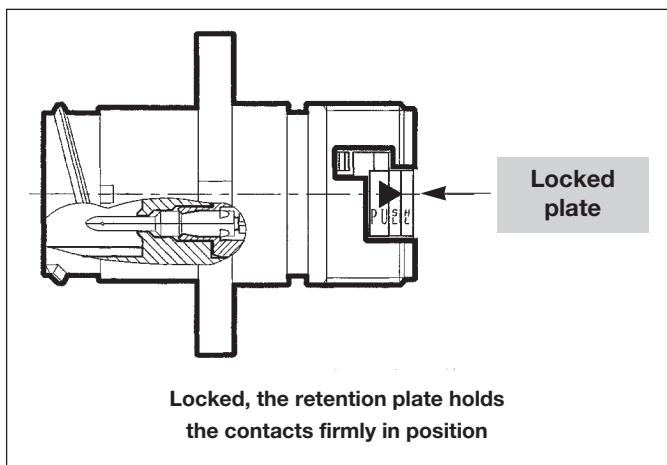





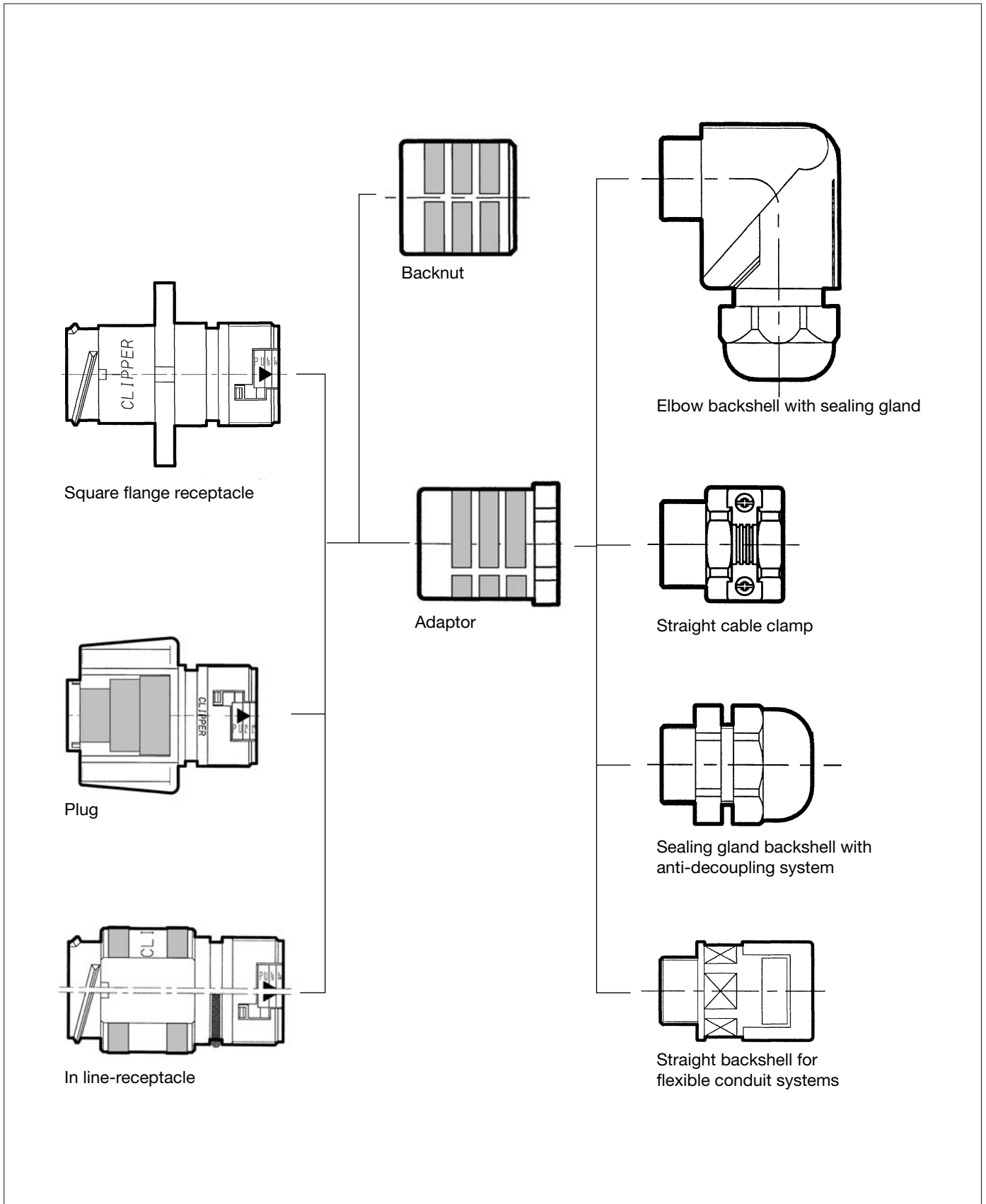





Styles available













Square flange receptacle and in-line receptacle

Receptacle types without contacts		Part numbers								
		Unsealed receptacle (without o'ring)		Sealed receptacle (with o'ring) for use with backshell		Sealed receptacle (with o'ring and panel gasket)		In-line receptacle		
		for male contacts	for female contacts	for male contacts	for female contacts	for male contacts	for female contacts	unsealed for male contacts	sealed for male contacts	
Shell sizes	1	4 cts Ø 1.6 mm  Class 2 - VDE 380 V	CL1M1100	CL1R1100	CL1M1101	CL1R1101	CL1M1102	CL1R1102	CL1C1100	CL1C1101
		9 cts Ø 1 mm 	CL1M1200		CL1M1201		CL1M1202		CL1C1200	CL1C1201
	2	9 cts Ø 1.6 mm  Class 2 - VDE 250 V	CL1M2100	CL1R2100	CL1M2101	CL1R2101	CL1M2102	CL1R2102	CL1C2100	CL1C2101
		14 cts Ø 1 mm 	CL1M2200		CL1M2201		CL1M2202		CL1C2200	CL1C2201
	3	18 cts Ø 1.6 mm  Class 2 - VDE 250 V	CL1M3100	CL1R3100	CL1M3101	CL1R3101	CL1M3102	CL1R3102	CL1C3100	CL1C3101
		31 cts Ø 1 mm 	CL1M3200		CL1M3201		CL1M3202		CL1C3200	CL1C3201
	4	26 cts Ø 1.6 mm  Class 2 - VDE 250 V	CL1M4100		CL1M4101		CL1M4102		CL1C4100	CL1C4101
		40 cts Ø 1.6 mm 	CL1M4200	CL1R4200	CL1M4201	CL1R4201	CL1M4202	CL1R4202	CL1C4200	CL1C4201



Plug and backnut

Contact layouts		Part numbers								
		Plug types without contacts		Unsealed plug (without o'ring and mating seal)		Sealed plug (with o'ring and mating seal)		Backnut sealed		Backnut unsealed
		for male contacts	for female contacts	for male contacts	for female contacts	for male contacts	for female contacts	for male contacts	for female contacts	for male and female contacts
Shell sizes	1	4 cts Ø 1.6 mm Class 2 - VDE 380 V 	CL1P1100	CL1F1100	CL1P1101	CL1F1101 (IP67) CL1F1103 (IP68)	CL111102	CL111101	CL111000	
		9 cts Ø 1 mm 		CL1F1200		CL1F1201 (IP67) CL1F1203 (IP68)	CL111202	CL111201		
	2	9 cts Ø 1.6 mm Class 2 - VDE 250 V 	CL1P2100	CL1F2100	CL1P2101	CL1F2101 (IP67) CL1F2103 (IP68)	CL112102	CL112101	CL112000	
		14 cts Ø 1 mm 		CL1F2200		CL1F2201 (IP67) CL1F2203 (IP68)				
	3	18 cts Ø 1.6 mm Class 2 - VDE 250 V 	CL1P3100	CL1F3100	CL1P3101	CL1F3101 (IP67) CL1F3103 (IP68)	CL113102	CL113101	CL113000	
		31 cts Ø 1 mm 		CL1F3200		CL1F3201 (IP67) CL1F3203 (IP68)				
	4	26 cts Ø 1.6 mm Class 2 - VDE 380 V 		CL1F4100		CL1F4101 (IP67) CL1F4103 (IP68)	CL114102	CL114101	CL114000	
		40 cts Ø 1.6 mm 	CL1P4200	CL1F4200	CL1P4201	CL1F4201 (IP67) CL1F4203 (IP68)	CL114202	CL114201		

Adaptor and electrical thread backshells (PG)

Unsealed

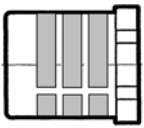
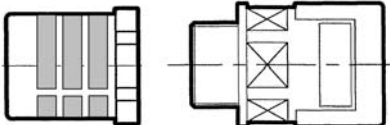
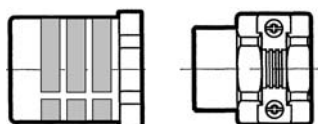
Type	Description	Part numbers				
		Shell sizes				
		1 (PG 13.5)	2 (PG 16)	3 (PG 21)	4 (PG 29)	4 (PG 36)
	Adaptor	CL101000	CL102000	CL103000	CL124000	CL104000
	Straight backshell for flexible conduit systems	CL101040	CL102040	CL103040	CL124040	CL104040
	Straight cable clamp	CL101030	CL102030	CL103030	CL124030	-

Sealed

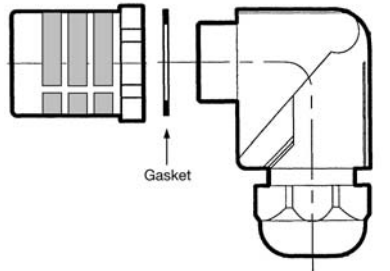
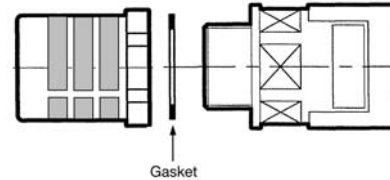
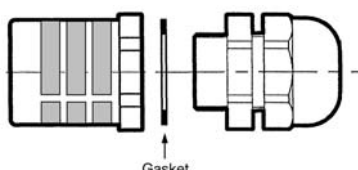
	Elbow backshell with sealing gland IP67	CL101051	CL102051	CL103051	CL124051	-
	Straight backshell for flexible conduit systems IP67	CL101041	CL102041	CL103041	CL124041	CL104041
	Anti-decoupling sealing gland backshell IP68	CL101021	CL102021	CL103021	CL124021	CL104021

Note : Electrical thread backshells are always supplied complete with the adaptor.

Accessories

Panel gasket (for square flange receptacle)

Shell sizes	1	2	3	4
Part numbers	CL191001	CL192001	CL193001	CL194001

Elbow adaptors for receptacles

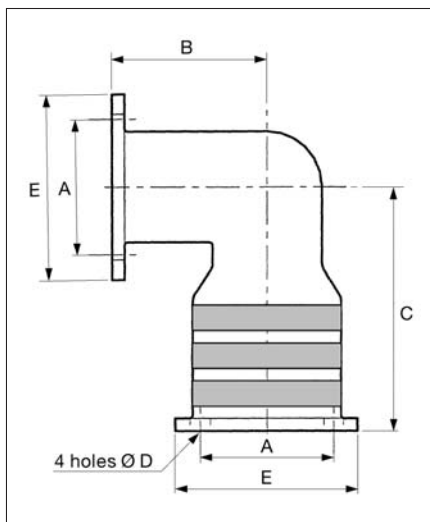

Shell sizes	Dim. (mm)				
	A	B	C	D	E
1	21.4	24.5	38.7	3.2	29.2
2	24.6	28.0	39.7	3.2	30.8
3	28.5	30.5	42.8	3.8	35.6
4	36.5	39.4	49.5	3.8	47.5

Elbow adaptors for receptacles Shell 1 to 4		
Shell	Part numbers	
	Sealed	Unsealed
1	CL131001	CL131000
2	CL132001	CL132000
3	CL133001	CL133000
4	CL134001	CL134000

Dust cap for receptacle IP67

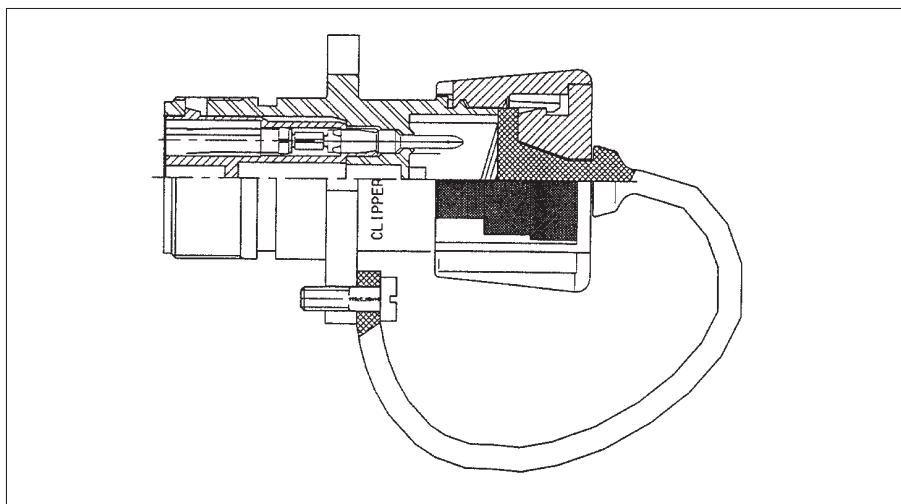

Shell	Part numbers
1	CL141001
2	CL142001
3	CL143001
4	CL144001

Stamped and formed contacts

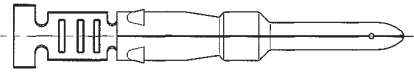
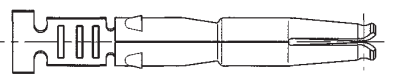
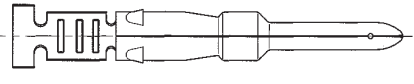
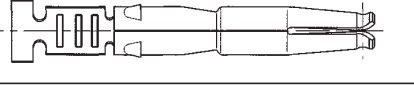
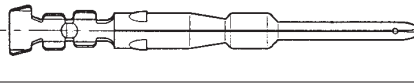
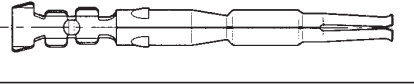
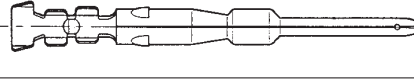
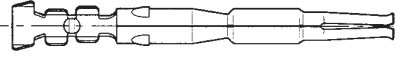
Packaging	Contact types with insulation support		∅ (mm)	Wire insul. diameter ∅ (mm)	Cable acceptance (mm ²)	Part numbers
Bulk		male	1.6	2.00 min.	0.70 to 1.50	CF16PC10RF
		female		3.00 Max.	0.70 to 1.50	CF16SC10RF
Reel 5000 pieces		male	1.6	2.00 min.	0.70 to 1.50	CF16PC19RF
		female		3.00 Max.	0.70 to 1.50	CF16SC19RF
Bulk		male	1	1.20 min.	0.35 to 0.60	CF10PC10RF
		female		2.10 Max.	0.35 to 0.60	CF10SC10RF
Reel 5000 pieces		male	1	1.20 min.	0.35 to 0.60	CF10PC19RF
		female		2.10 Max.	0.35 to 0.60	CF10SC19RF

Plating RF : gold flash on active part for standard version.

Filler plug ∅ 1.6 mm
(for un-used contact cavities)

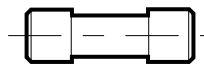

Part number : 8500 479 CL

For other platings, consult FCI.