

## General Description

The DPA Series ChipSwitch uses exclusive International Rectifier S<sup>3</sup>X power integrated circuit technology to form a fully functioning solid-state relay. The S<sup>3</sup>X technology combines MOS and bipolar processes, derived from IR's HEXFET® power MOSFET designs, to eliminate the need for both discrete components and hybrid circuits. The basic DPA Series ChipSwitch consists of two identical power integrated circuits connected in inverse parallel (analogous to back-to-back SCRs) for AC control plus an isolated GaAlAs light emitting diode (LED) for actuation. Voltage controlled models with an internal resistor to limit the control current are also available.

Extreme reliability is achieved by the reduction of component count from approximately 20 discrete components in a conventional SSR to 3 basic components in the ChipSwitch.

The DPA Series ChipSwitch is a single-pole, normally-open SSR capable of switching up to 1.0 ARMS load currents with precise zero-voltage turn-on and zero-current turn-off, thus reducing EMI emissions.

These devices are ideally suited for interfacing microprocessors to AC loads, such as small motors, lamps, solenoids, valves and high power motor starters. The economy of the DPA Series ChipSwitch allows the in-house manufacturer to replace assemblies of triacs, triac drivers and associated components with a highly reliable, miniature, standard SSR.

## DPA Series Features

- S<sup>3</sup>X power IC chips ■
- 25 Amp surge ■
- 4,000 V<sub>RMS</sub> I/O isolation ■
- 10 µA off-state leakage current ■
- Zero-voltage turn-on ■
- Operates without snubber ■
- 600 V/µs off-state dv/dt ■
- Solid-State reliability ■
- UL recognized and CSA certified ■

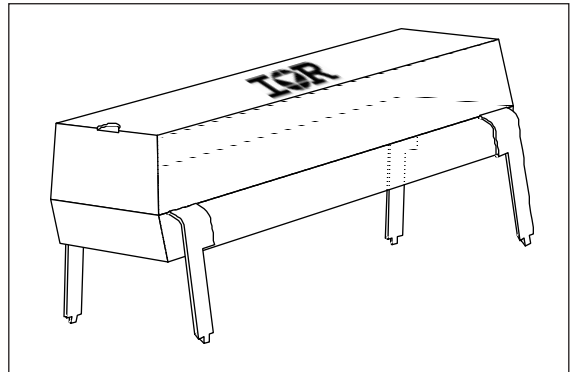

## Part Identification

Part Number	Transient Overvoltage (V <sub>PEAK</sub> )	Operating Voltage (V <sub>RMS</sub> )	DC Input Sensitivity (Turn-On)
DPA4111	400	20-140	10mA
DPA4119	400	20-140	3.5V
DPA6111	600	20-280	10mA
DPA6119	600	20-280	3.5V

*(ChipSwitch and HEXFET are trademarks of International Rectifier)*

# Series DPA — ChipSwitch® DIP Relay

International  
 Rectifier

**Electrical Specifications** ( $-30^{\circ}\text{C} \leq T_A \leq +85^{\circ}\text{C}$  unless otherwise specified)

INPUT CHARACTERISTICS	Limits	Units
Maximum Turn-On Current: DPA4111, DPA6111	10.0	mA
Minimum Turn-Off Current: DPA4111, DPA6111	0.5	mA
Control Current Range (Caution: current limit input LED, see figure 3) DPA4111, DPA6111 (see figure 4 for DPA4119, DPA6119)	10 to 25	mA
Maximum Turn-On Voltage: DPA4119, DPA6119	3.5	V
Minimum Turn-Off Voltage: DPA4119, DPA6119	0.8	V
Control Voltage Range: DPA4119, DPA6119	3.5 to 7	V
Maximum Reverse Voltage (All Models)	7.0	V

OUTPUT CHARACTERISTICS	Limits		Units
	DPA4111 DPA4119	DPA6111 DPA6119	
Operating Voltage Range (47 - 63 Hz)	20-140	20-280	$V_{\text{RMS}}$
Transient Overvoltage (non-repetitive)	400	600	$V_{\text{PEAK}}$
Maximum Load Current @ $T_A=+40^{\circ}\text{C}$ (see figure 1) (see Note 3)	1.0		$A_{\text{RMS}}$
Minimum Load Current	0.5		$\text{mA}_{\text{RMS}}$
Minimum Off-State dv/dt (see Note 1)	600		$\text{V}/\mu\text{S}$
Power Factor Range	0.2 to 1.0		—
Maximum On-State Voltage Drop @ $1.0 A_{\text{RMS}}$	1.5		$V_{\text{PEAK}}$
Maximum Off-State Leakage Current (see Note 2)	10		$\mu A_{\text{RMS}}$
Maximum Turn-On Time (60 Hz)	8.3		ms
Maximum Turn-Off Time (60 Hz)	8.3		ms
Maximum Surge Current, Single-Cycle, Non-Repetitive 20 ms (see figure 2)	25		$A_{\text{PEAK}}$
Maximum Overcurrent, Non-Repetitive 1 second	7.5		$A_{\text{PEAK}}$
Maximum $I^2T$ for Fusing (0.01 sec)	4.5		$A^2\text{s}$
Maximum Zero Voltage Turn-on	12		$V_{\text{PEAK}}$

GENERAL CHARACTERISTICS	Limits	Units	
Minimum Dielectric Strength, Input-Output	4000	$V_{\text{RMS}}$	
Minimum Insulation Resistance, Input-Output, @ $T_A=+25^{\circ}\text{C}$ , 50%RH, 500V <sub>DC</sub>	$10^{12}$	$\Omega$	
Tracking Resistance (VDE Test)	KB 100/A	—	
Maximum Capacitance, Input-Output	2.0	pF	
Maximum Pin Soldering Temperature (10 seconds maximum)	+260	$^{\circ}\text{C}$	
Ambient Temperature Range:	Operating		-30 to +85
	Storage		-40 to +100

## Notes:

- Off-state dv/dt test method per EIA/NARM standard RS-443 with  $V_p$  equal to the instantaneous peak of the maximum operating voltage.
- LED input current of zero mA (DPA4111, DPA6111) or input voltage of zero Volts (DPA4119, DPA61119).
- The UL508 motor control rating per Sec. 52 overload test conditions is 0.4A max., and general purpose and incandescent load control rating is 1.0A.

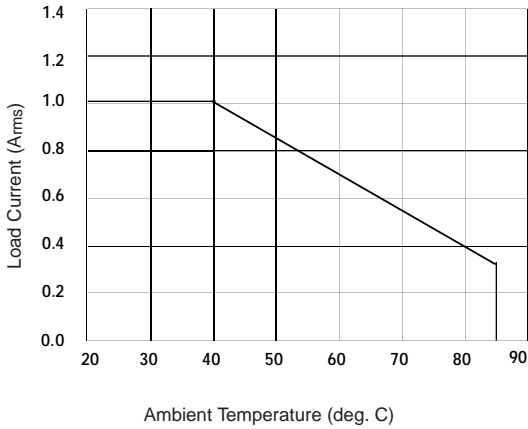

Figure 1. Derating Curve, Free Standing

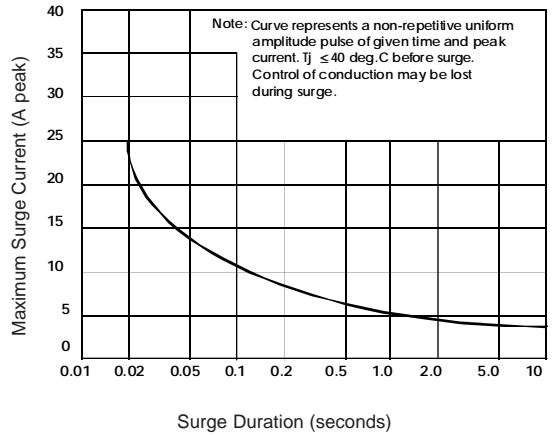

Figure 2. Maximum Allowable Surge

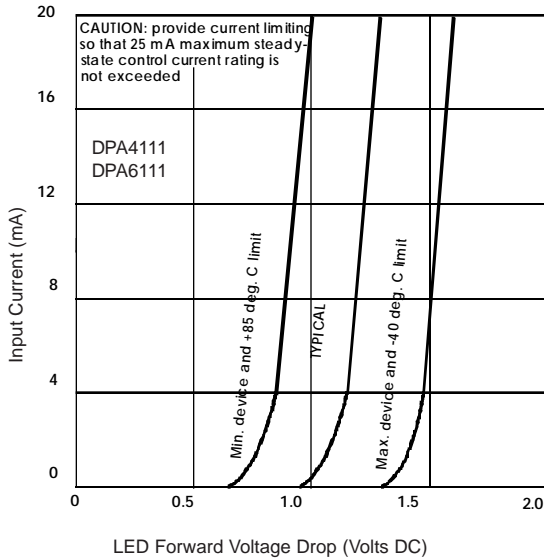

Figure 3. Input Characteristics (Current Controlled)

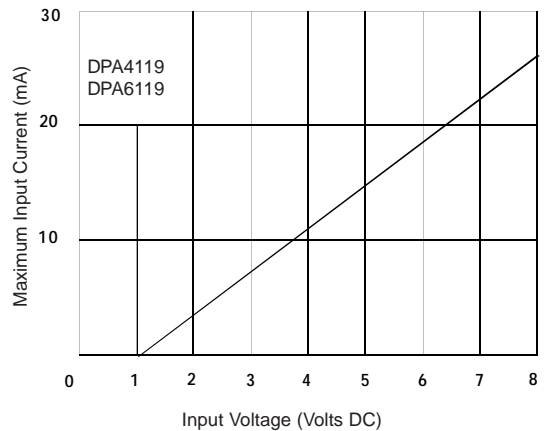
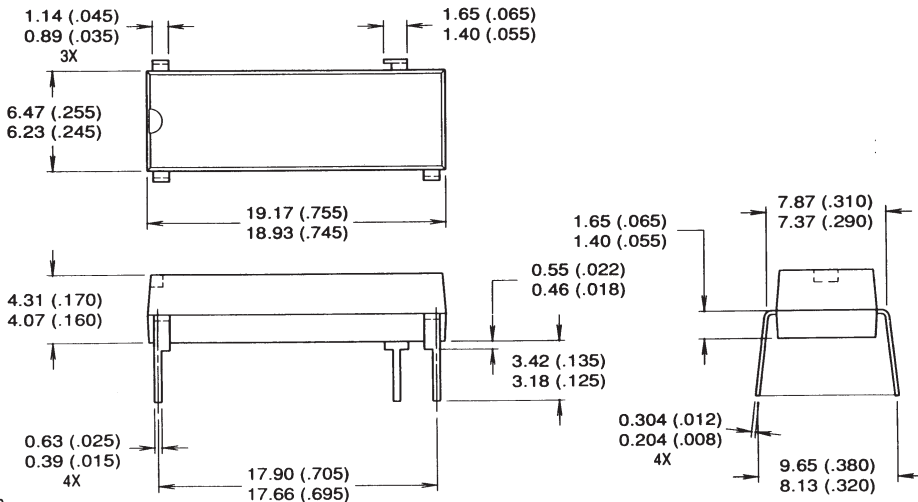

Figure 4. Input Characteristics (Voltage Controlled)

# Series DPA — ChipSwitch® DIP Relay

## Case Outline

Dimensions in millimeters (inches)



- NOTES:  
 1. CONTROLLING DIMENSION: INCH.  
 2. ALL DIMENSIONS ARE SHOWN IN MILLIMETERS (INCHES).

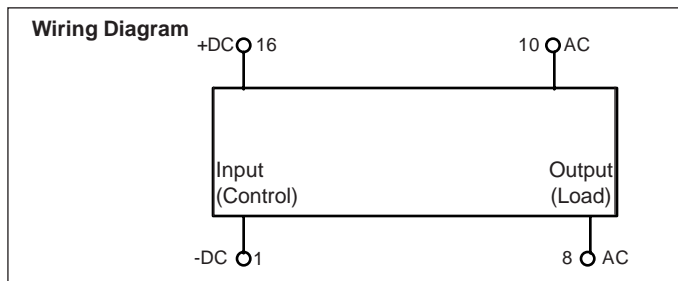

**WORLD HEADQUARTERS:** 233 Kansas St., El Segundo, California 90245, Tel: (310) 322 3331

**EUROPEAN HEADQUARTERS:** Hurst Green, Oxted, Surrey RH8 9BB, UK Tel: ++ 44 1883 713215

**IR CANADA:** 7321 Victoria Park Ave., Suite 201, Markham, Ontario L3R 2Z8, Tel: (905) 475 1897

**IR GERMANY:** Saalburgstrasse 157, 61350 Bad Homburg Tel: ++ 49 6172 96590

**IR ITALY:** Via Liguria 49, 10071 Borgaro, Torino Tel: ++ 39 11 451 0111

**IR FAR EAST:** K&H Bldg., 2F, 3-30-4 Nishi-Ikeburo 3-Chome, Toshima-Ku, Tokyo, Japan 171 Tel: ++ 81 3 3983 0641

**IR SOUTHEAST ASIA:** 315 Outram Road, #10-02 Tan Boon Liat Building, Singapore 0316 Tel: ++ 65 221 8371

<http://www.irf.com/>

Data and specifications subject to change without notice. 9/96