

LM431 Adjustable Precision Zener Shunt Regulator

General Description

The LM431 is a 3-terminal adjustable shunt regulator with guaranteed temperature stability over the entire temperature range of operation. The output voltage may be set at any level greater than 2.5V (V_{REF}) up to 36V merely by selecting two external resistors that act as a voltage divided network. Due to the sharp turn-on characteristics this device is an excellent replacement for many zener diode applications.

Features

- Average temperature coefficient 50 ppm/°C
- Temperature compensated for operation over the full temperature range
- Programmable output voltage
- Fast turn-on response
- Low output noise

Connection Diagrams

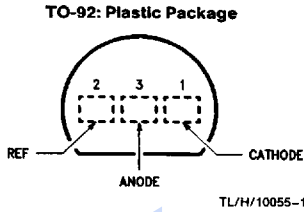

Top View
Order Number LM431ACZ,
LM431AIZ,
LM431BCZ, LM431BIZ, LM431CCZ
or LM431CIZ

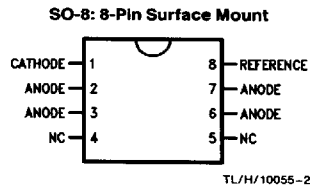

Top View
Order Number LM431ACM,
LM431AIM,
LM431BCM, LM431BIM, LM431CCM
or LM431CIM

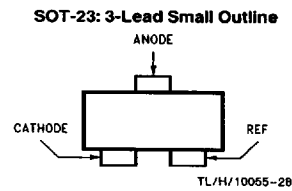

Top View
Order Number LM431ACM3,
LM431AIM3,
LM431BCM3, LM431BIM3,
LM431CCM3
or LM431CIM3

Ordering Information*

| Package | Typical Accuracy | | | Temperature Range |
|---------|------------------------|------------------------|------------------------|--------------------------------|
| | 0.5% | 1% | 2% | |
| TO-92 | LM431CCZ LM431CIZ | LM431BCZ LM431BIZ | LM431ACZ LM431AIZ | 0°C to +70°C -40°C to +85°C |
| SO-8 | LM431CCM LM431CIM | LM431BCM LM431BIM | LM431ACM LM431AIM | 0°C to +70°C -40°C to +85°C |
| SOT-23 | LM431CCM3 LM431CIM3 | LM431BCM3 LM431BIM3 | LM431ACM3 LM431AIM3 | 0°C to +70°C -40°C to +85°C |

*See Table 1 for package marking for SOT-23.

Absolute Maximum Ratings

If Military/Aerospace specified devices are required, please contact the National Semiconductor Sales Office/Distributors for availability and specifications.

| | |
|--|-----------------|
| Storage Temperature Range | -65°C to +150°C |
| Operating Temperature Range | |
| Industrial (LM431xI) | -40°C to +85°C |
| Commercial (LM431xC) | 0°C to +70°C |
| Lead Temperature | |
| TO-92 Package/SO-8 Package/SOT-23 Package (Soldering, 10 sec.) | 265°C |
| Internal Power Dissipation (Notes 1, 2) | |
| TO-92 Package | 0.78W |
| SO-8 Package | 0.81W |
| SOT-23 Package | 0.28W |

| | | |
|----------------------------|-------------------|------------|
| Cathode Voltage | | 37V |
| Continuous Cathode Current | -10 mA to +150 mA | |
| Reference Voltage | | -0.5V |
| Reference Input Current | | 10 mA |
| Operating Conditions | Min | Max |
| Cathode Voltage | V _{REF} | 37V |
| Cathode Current | 1.0 mA | 100 mA |

Note 1: T_J Max = 150°C.

Note 2: Ratings apply to ambient temperature at 25°C. Above this temperature, derate the TO-92 at 6.2 mW/°C, the SO-8 at 6.5 mW/°C, and the SOT-23 at 2.2 mW/°C.

LM431

Electrical Characteristics T_A = 25°C unless otherwise specified

| Symbol | Parameter | Conditions | Min | Typ | Max | Units |
|-------------------------------------|---|--|-------|-------|-------|-------|
| V _{REF} | Reference Voltage | V _Z = V _{REF} , I _I = 10 mA LM431A (Figure 1) | 2.440 | 2.495 | 2.550 | V |
| | | V _Z = V _{REF} , I _I = 10 mA LM431B (Figure 1) | 2.470 | 2.495 | 2.520 | V |
| | | V _Z = V _{REF} , I _I = 10 mA LM431C (Figure 1) | 2.485 | 2.500 | 2.510 | V |
| V _{DEV} | Deviation of Reference Input Voltage Over Temperature (Note 3) | V _Z = V _{REF} , I _I = 10 mA, T _A = Full Range (Figure 1) | | 8.0 | 17 | mV |
| $\frac{\Delta V_{REF}}{\Delta V_Z}$ | Ratio of the Change in Reference Voltage to the Change in Cathode Voltage | I _Z = 10 mA (Figure 2) | | | | mV/V |
| | | V _Z from V _{REF} to 10V | | -1.4 | -2.7 | |
| | | V _Z from 10V to 36V | | -1.0 | -2.0 | |
| I _{REF} | Reference Input Current | R ₁ = 10 kΩ, R ₂ = ∞, I _I = 10 mA (Figure 2) | | 2.0 | 4.0 | μA |
| ΔI _{REF} | Deviation of Reference Input Current over Temperature | R ₁ = 10 kΩ, R ₂ = ∞, I _I = 10 mA, T _A = Full Range (Figure 2) | | 0.4 | 1.2 | μA |
| I _{Z(MIN)} | Minimum Cathode Current for Regulation | V _Z = V _{REF} (Figure 1) | | 0.4 | 1.0 | mA |
| I _{Z(OFF)} | Off-State Current | V _Z = 36V, V _{REF} = 0V (Figure 3) | | 0.3 | 1.0 | μA |
| r _Z | Dynamic Output Impedance (Note 4) | V _Z = V _{REF} , LM431A, Frequency = 0 Hz (Figure 1) | | | 0.75 | Ω |
| | | V _Z = V _{REF} , LM431B, LM431C Frequency = 0 Hz (Figure 1) | | | 0.50 | Ω |

LM431

Electrical Characteristics $T_A = 25^\circ\text{C}$ unless otherwise specified (Continued)

Note 3: Deviation of reference input voltage, V_{DEV} , is defined as the maximum variation of the reference input voltage over the full temperature range.

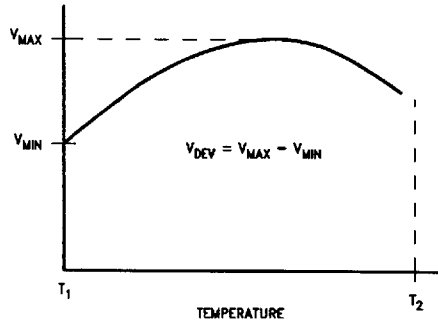

TL/H/10055-7

The average temperature coefficient of the reference input voltage, αV_{REF} , is defined as:

$$\alpha V_{REF} \frac{\text{ppm}}{^\circ\text{C}} = \frac{\pm \left[\frac{V_{\text{Max}} - V_{\text{Min}}}{V_{\text{REF}}(\text{at } 25^\circ\text{C})} \right] 10^6}{T_2 - T_1} = \frac{\pm \left[\frac{V_{\text{DEV}}}{V_{\text{REF}}(\text{at } 25^\circ\text{C})} \right] 10^6}{T_2 - T_1}$$

Where:

$T_2 - T_1$ = full temperature change.

αV_{REF} can be positive or negative depending on whether the slope is positive or negative.

Example: $V_{DEV} = 8.0 \text{ mV}$, $V_{REF} = 2495 \text{ mV}$, $T_2 - T_1 = 70^\circ\text{C}$, slope is positive.

$$\alpha V_{REF} = \frac{\left[\frac{8.0 \text{ mV}}{2495 \text{ mV}} \right] 10^6}{70^\circ\text{C}} = +46 \text{ ppm}/^\circ\text{C}$$

Note 4: The dynamic output impedance, r_z , is defined as:

$$r_z = \frac{\Delta V_Z}{\Delta I_Z}$$

When the device is programmed with two external resistors, R_1 and R_2 , (see *Figure 2*), the dynamic output impedance of the overall circuit, r_z , is defined as:

$$r_z = \frac{\Delta V_Z}{\Delta I_Z} = \left[r_z \left(1 + \frac{R_1}{R_2} \right) \right]$$

Equivalent Circuit

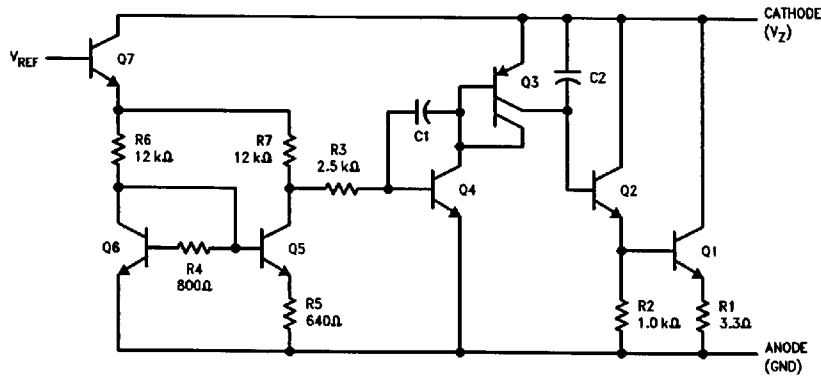

DC Test Circuits

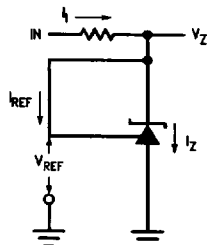
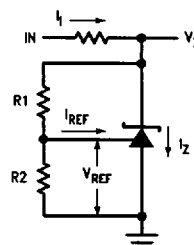

FIGURE 1. Test Circuit for $V_Z = V_{REF}$



Note: $V_Z = V_{REF} (1 + R1/R2) + I_{REF} \cdot R1$
FIGURE 2. Test Circuit for $V_Z > V_{REF}$

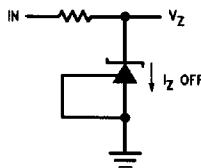
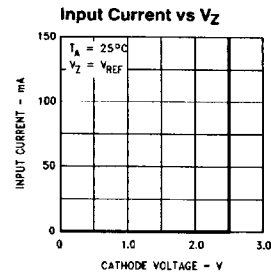
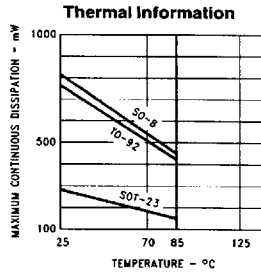
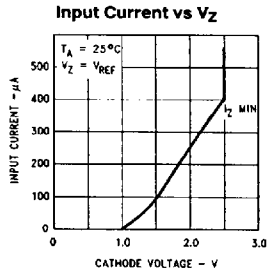
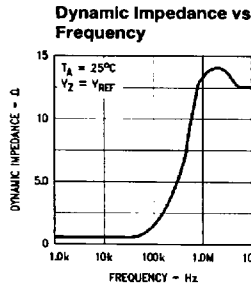

FIGURE 3. Test Circuit for Off-State Current

Typical Performance Characteristics



TL/H/10055-8



TL/H/10055-9

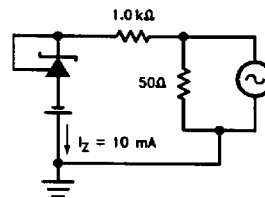

TL/H/10055-10

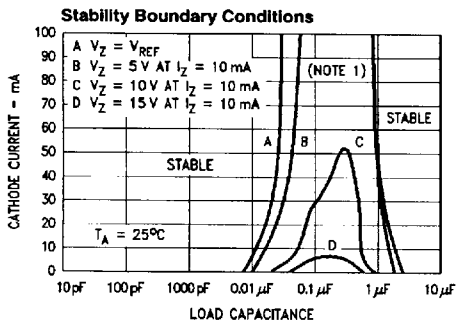

TL/H/10055-11

Note 1: The areas under the curves represent conditions that may cause the device to oscillate. For curves B, C, and D, R_2 and V^+ were adjusted to establish the initial V_Z and I_Z conditions with $C_L = 0$. V^+ and C_L were then adjusted to determine the ranges of stability.

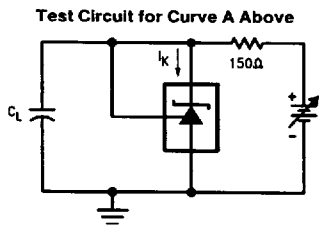

TL/H/10055-12

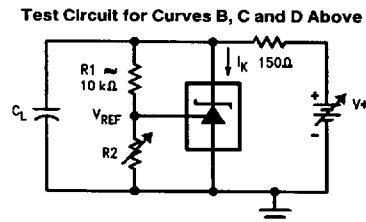

TL/H/10055-13

Typical Applications

Shunt Regulator

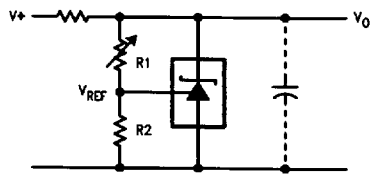

TL/H/10055-14

$$V_O \approx \left(1 + \frac{R_1}{R_2}\right) V_{REF}$$

Series Regulator

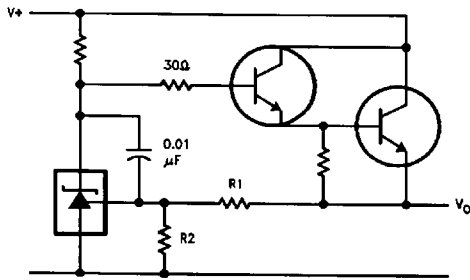

TL/H/10055-16

$$V_O \approx \left(1 + \frac{R_1}{R_2}\right) V_{REF}$$

Single Supply Comparator with Temperature Compensated Threshold

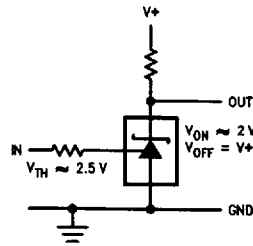

TL/H/10055-15

Output Control of a Three Terminal Fixed Regulator

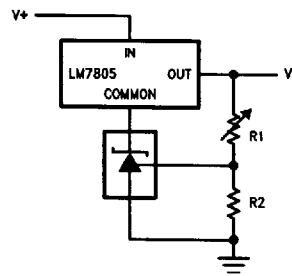

TL/H/10055-17

$$V_O = \left(1 + \frac{R_1}{R_2}\right) V_{REF}$$

$$V_{O \text{ MIN}} = V_{REF} + 5V$$

Typical Applications (Continued)

Higher Current Shunt Regulator

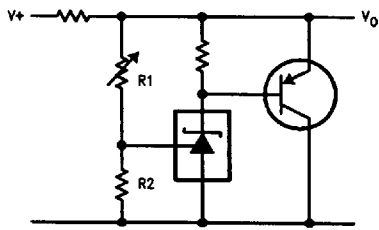

TL/H/10055-18

$$V_O = \left(1 + \frac{R1}{R2}\right) V_{REF}$$

Crow Bar

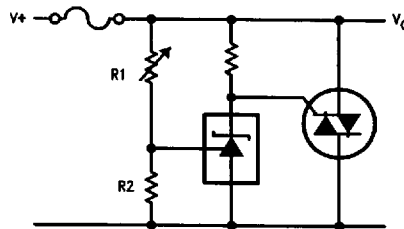

TL/H/10055-19

$$V_{LIMIT} \approx \left(1 + \frac{R1}{R2}\right) V_{REF}$$

Over Voltage/Under Voltage Protection Circuit

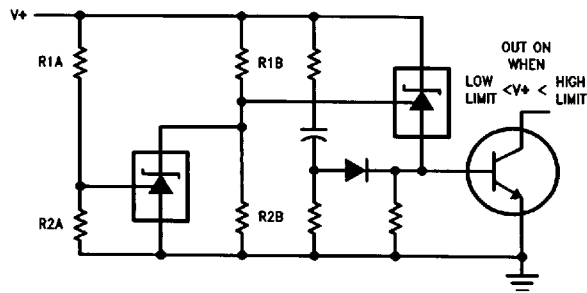

TL/H/10055-20

$$LOW\ LIMIT \approx V_{REF} \left(1 + \frac{R1B}{R2B}\right) + V_{BE}$$

$$HIGH\ LIMIT \approx V_{REF} \left(1 + \frac{R1A}{R2A}\right)$$

Voltage Monitor

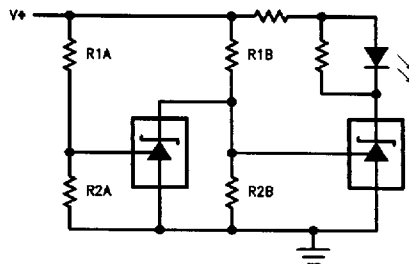

TL/H/10055-21

$$LOW\ LIMIT \approx V_{REF} \left(1 + \frac{R1B}{R2B}\right) \quad LED\ ON\ WHEN\ LOW\ LIMIT < V^+ < HIGH\ LIMIT$$

$$HIGH\ LIMIT \approx V_{REF} \left(1 + \frac{R1A}{R2A}\right)$$

Typical Applications (Continued)

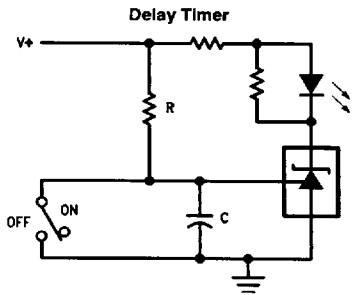

TL/H/10055-22

$$\text{DELAY} = R \cdot C \cdot \ln \frac{V^+}{(V^+) - V_{REF}}$$

$$I_o = \frac{V_{REF}}{R_{CL}}$$

Current Limiter or Current Source

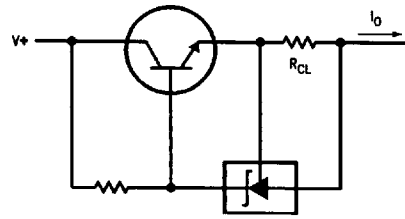

TL/H/10055-23

Constant Current Sink

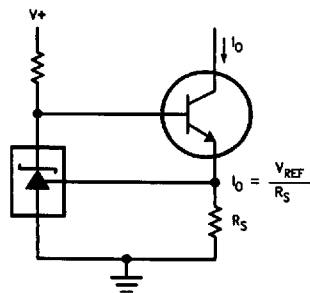

TL/H/10055-24

$$I_o = \frac{V_{REF}}{R_S}$$

Recommended Solder Pads for SOT-23 Package

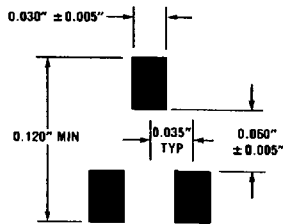

TL/H/10055-27

TABLE 1. Package Marking for SOT-23

| Order Number | Top Mark |
|--------------|----------|
| LM431ACM3 | N1F |
| LM431AIM3 | N1E |
| LM431BCM3 | N1D |
| LM431BIM3 | N1C |
| LM431CCM3 | N1B |
| LM431CIM3 | N1A |

Physical Dimensions inches (millimeters) unless otherwise noted

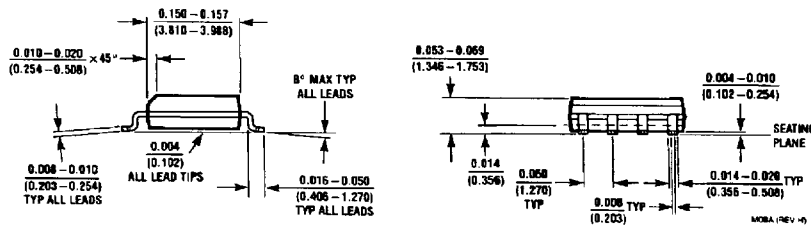
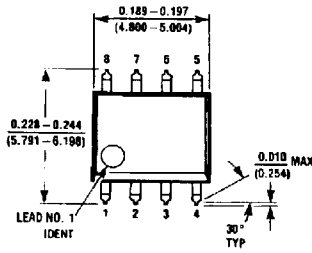

Order Number LM431ACM or LM431AIM
NS Package Number M08A

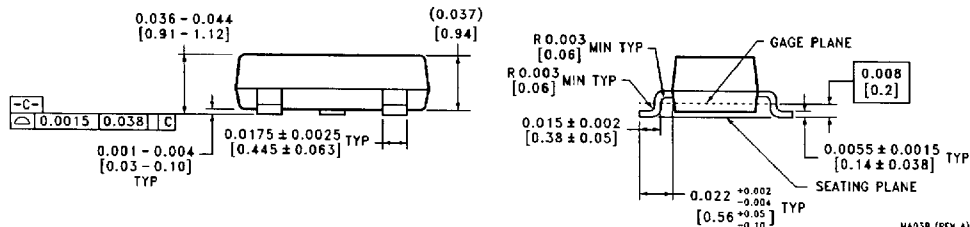
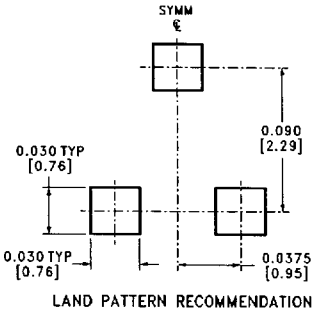
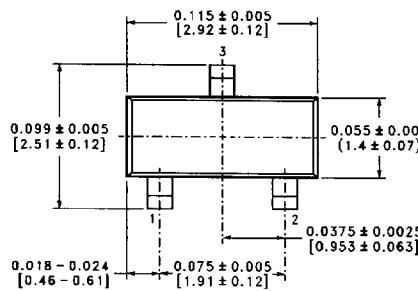

SOT-23 Molded Small Outline Transistor Package (M3)
Order Number LM60BIM3 or LM60CIM3
NS Package Number MA03B

Physical Dimensions inches (millimeters) unless otherwise noted (Continued)

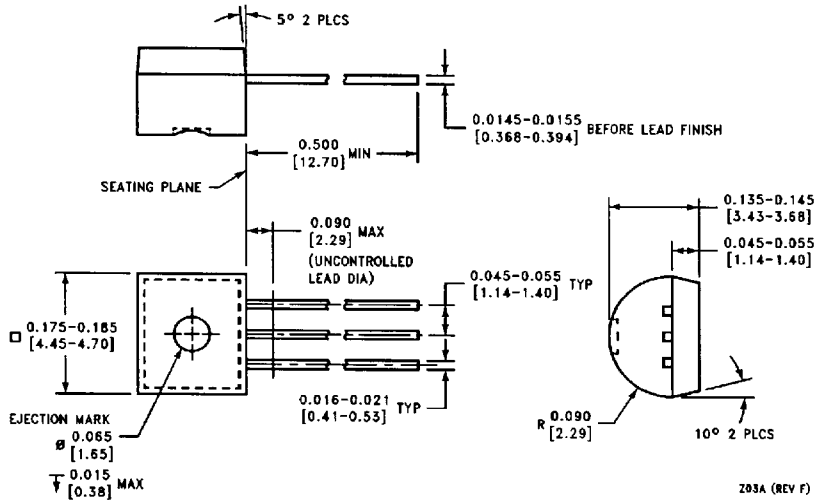

Order Number LM431ACZ or LM431AIZ
NS Package Number Z03A

Z03A (REV F)

LIFE SUPPORT POLICY

NATIONAL'S PRODUCTS ARE NOT AUTHORIZED FOR USE AS CRITICAL COMPONENTS IN LIFE SUPPORT DEVICES OR SYSTEMS WITHOUT THE EXPRESS WRITTEN APPROVAL OF THE PRESIDENT OF NATIONAL SEMICONDUCTOR CORPORATION. As used herein:

1. Life support devices or systems are devices or systems which, (a) are intended for surgical implant into the body, or (b) support or sustain life, and whose failure to perform, when properly used in accordance with instructions for use provided in the labeling, can be reasonably expected to result in a significant injury to the user.
2. A critical component is any component of a life support device or system whose failure to perform can be reasonably expected to cause the failure of the life support device or system, or to affect its safety or effectiveness.



National Semiconductor Corporation
Americas
Tel: 1(800) 272-9959
Fax: 1(800) 737-7018
Email: support@nsc.com

National Semiconductor Europe
Fax: +49 (0) 180-530 85 86
Email: europe.support@nsc.com
Deutsch Tel: +49 (0) 180-530 85 85
English Tel: +49 (0) 180-532 78 32
Français Tel: +49 (0) 180-532 93 58
Italiano Tel: +49 (0) 180-534 16 80

National Semiconductor Southeast Asia
Fax: (852) 2376 3901
Email: sea.support@nsc.com

National Semiconductor Japan Ltd.
Tel: 81-3-5620-7561
Fax: 81-3-5620-6179

<http://www.national.com>

National does not assume any responsibility for use of any circuitry described, no circuit patent licenses are implied and National reserves the right at any time without notice to change said circuitry and specifications.

6501124 0106047 780