

# Complementary Silicon Power Transistors

The 2N3773 and 2N6609 are PowerBase™ power transistors designed for high power audio, disk head positioners and other linear applications. These devices can also be used in power switching circuits such as relay or solenoid drivers, dc to dc converters or inverters.

- High Safe Operating Area (100% Tested) 150 W @ 100 V
- Completely Characterized for Linear Operation
- High DC Current Gain and Low Saturation Voltage
  - $h_{FE} = 15$  (Min) @ 8 A, 4 V
  - $V_{CE(sat)} = 1.4$  V (Max) @  $I_C = 8$  A,  $I_B = 0.8$  A
- For Low Distortion Complementary Designs

**NPN**  
**2N3773\***  
**PNP**  
**2N6609**

\*ON Semiconductor Preferred Device

**16 AMPERE**  
**COMPLEMENTARY**  
**POWER TRANSISTORS**  
**140 VOLTS**  
**150 WATTS**

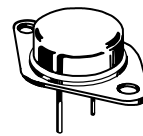

**CASE 1-07**  
**TO-204AA**  
**(TO-3)**

## \*MAXIMUM RATINGS

Rating	Symbol	Value	Unit
Collector Emitter Voltage	$V_{CEO}$	140	Vdc
Collector-Emitter Voltage	$V_{CEX}$	160	Vdc
Collector-Base Voltage	$V_{CBO}$	160	Vdc
Emitter-Base Voltage	$V_{EBO}$	7	Vdc
Collector Current — Continuous — Peak (1)	$I_C$	16 30	Adc
Base Current — Continuous — Peak (1)	$I_B$	4 15	Adc
Total Power Dissipation @ $T_C = 25^\circ\text{C}$ Derate above $25^\circ\text{C}$	$P_D$	150 0.855	Watts W/ $^\circ\text{C}$
Operating and Storage Junction Temperature Range	$T_J, T_{stg}$	-65 to +200	$^\circ\text{C}$

## THERMAL CHARACTERISTICS

Characteristic	Symbol	Max	Unit
Thermal Resistance, Junction to Case	$R_{\theta JC}$	1.17	$^\circ\text{C/W}$

\*Indicates JEDEC Registered Data.

(1) Pulse Test: Pulse Width = 5 ms, Duty Cycle  $\leq$  10%.

**Preferred** devices are ON Semiconductor recommended choices for future use and best overall value.

## 2N3773 2N6609

### ELECTRICAL CHARACTERISTICS (T<sub>C</sub> = 25°C unless otherwise noted)

Characteristic	Symbol	Min	Max	Unit
----------------	--------	-----	-----	------

#### OFF CHARACTERISTICS (2)

*Collector–Emitter Breakdown Voltage (I <sub>C</sub> = 0.2 Adc, I <sub>B</sub> = 0)	V <sub>CEO(sus)</sub>	140	—	Vdc
*Collector–Emitter Sustaining Voltage (I <sub>C</sub> = 0.1 Adc, V <sub>BE(off)</sub> = 1.5 Vdc, R <sub>BE</sub> = 100 Ohms)	V <sub>CEX(sus)</sub>	160	—	Vdc
Collector–Emitter Sustaining Voltage (I <sub>C</sub> = 0.2 Adc, R <sub>BE</sub> = 100 Ohms)	V <sub>CER(sus)</sub>	150	—	Vdc
*Collector Cutoff Current (V <sub>CE</sub> = 120 Vdc, I <sub>B</sub> = 0)	I <sub>CEO</sub>	—	10	mAdc
*Collector Cutoff Current (V <sub>CE</sub> = 140 Vdc, V <sub>BE(off)</sub> = 1.5 Vdc) (V <sub>CE</sub> = 140 Vdc, V <sub>BE(off)</sub> = 1.5 Vdc, T <sub>C</sub> = 150°C)	I <sub>CEX</sub>	— —	2 10	mAdc
Collector Cutoff Current (V <sub>CB</sub> = 140 Vdc, I <sub>E</sub> = 0)	I <sub>CBO</sub>	—	2	mAdc
*Emitter Cutoff Current (V <sub>BE</sub> = 7 Vdc, I <sub>C</sub> = 0)	I <sub>EBO</sub>	—	5	mAdc

#### ON CHARACTERISTICS (2)

DC Current Gain *(I <sub>C</sub> = 8 Adc, V <sub>CE</sub> = 4 Vdc) (I <sub>C</sub> = 16 Adc, V <sub>CE</sub> = 4 Vdc)	h <sub>FE</sub>	15 5	60 —	—
Collector–Emitter Saturation Voltage *(I <sub>C</sub> = 8 Adc, I <sub>B</sub> = 800 mAdc) (I <sub>C</sub> = 16 Adc, I <sub>B</sub> = 3.2 Adc)	V <sub>CE(sat)</sub>	— —	1.4 4	Vdc
*Base–Emitter On Voltage (I <sub>C</sub> = 8 Adc, V <sub>CE</sub> = 4 Vdc)	V <sub>BE(on)</sub>	—	2.2	Vdc

#### DYNAMIC CHARACTERISTICS

Magnitude of Common–Emitter Small–Signal, Short–Circuit, Forward Current Transfer Ratio (I <sub>C</sub> = 1 A, f = 50 kHz)	h <sub>fe</sub>	4	—	—
*Small–Signal Current Gain (I <sub>C</sub> = 1 Adc, V <sub>CE</sub> = 4 Vdc, f = 1 kHz)	h <sub>fe</sub>	40	—	—

#### SECOND BREAKDOWN CHARACTERISTICS

Second Breakdown Collector Current with Base Forward Biased t = 1 s (non–repetitive), V <sub>CE</sub> = 100 V, See Figure 12	I <sub>S/b</sub>	1.5	—	Adc
---	------------------	-----	---	-----

(2) Pulse Test: Pulse Width = 300 μs, Duty Cycle ≤ 2%.

\*Indicates JEDEC Registered Data.

NPN

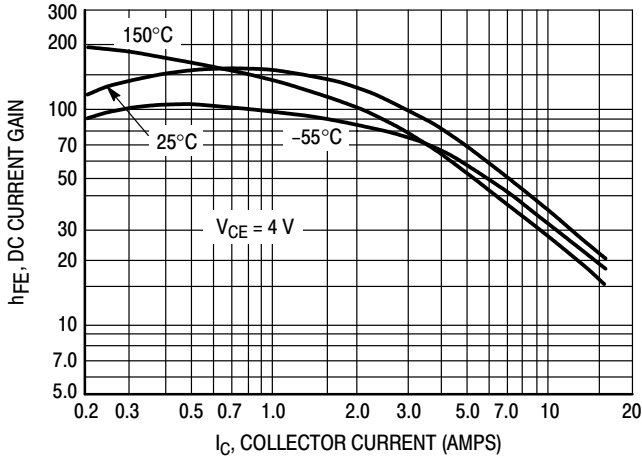

Figure 6. DC Current Gain

PNP

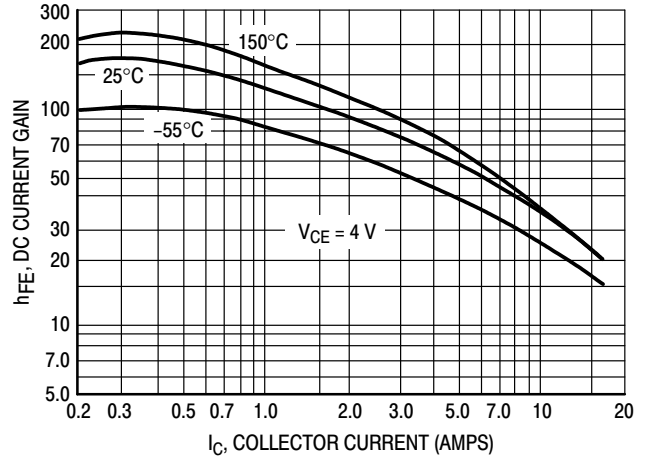

Figure 7. DC Current Gain

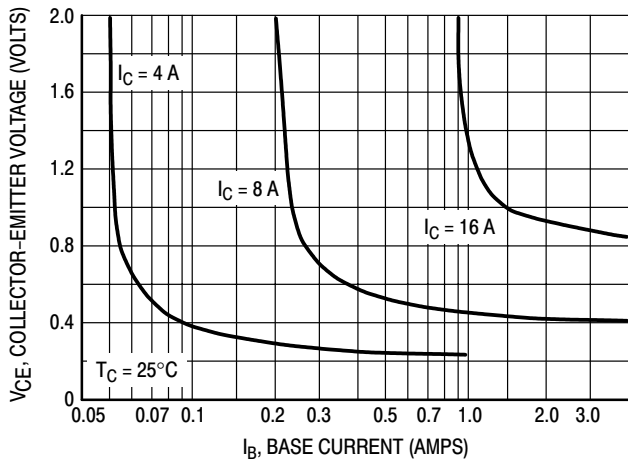

Figure 8. Collector Saturation Region

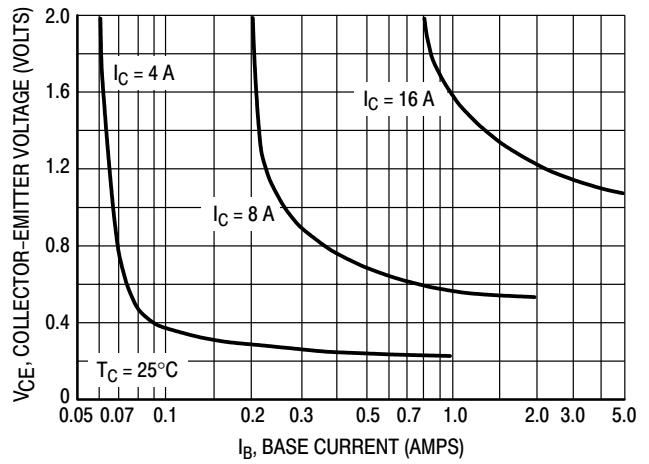

Figure 9. Collector Saturation Region

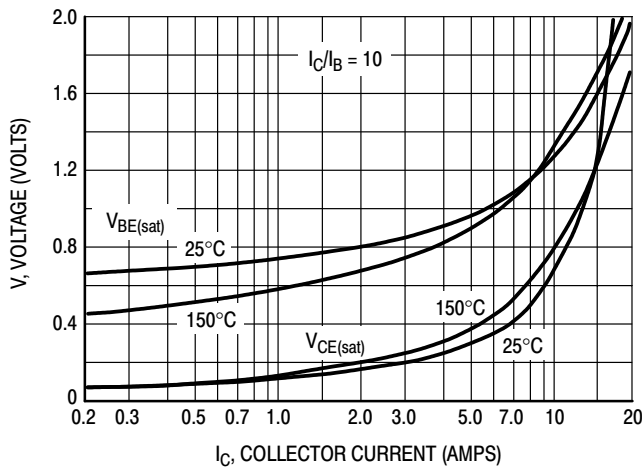

Figure 10. "On" Voltage

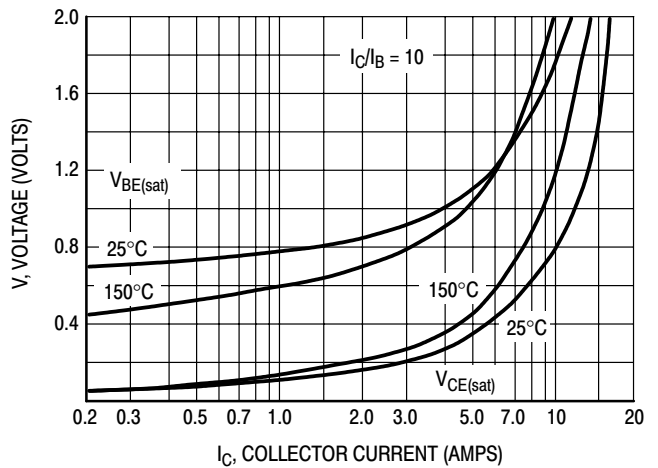
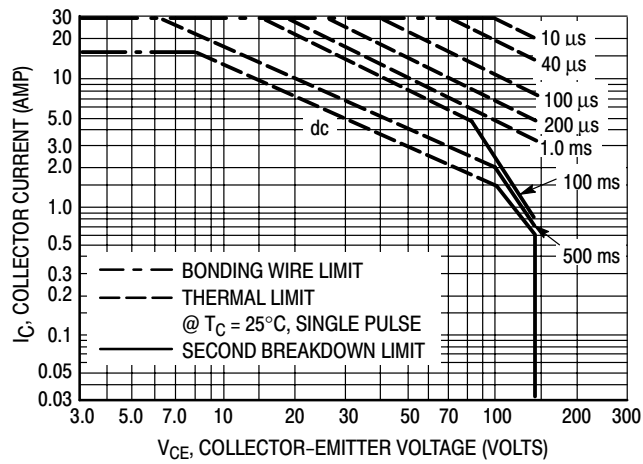

Figure 11. "On" Voltage

## 2N3773 2N6609

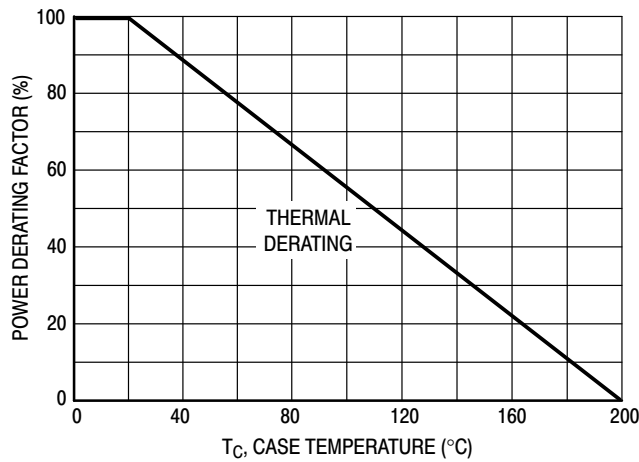

**Figure 12. Forward Bias Safe Operating Area**

There are two limitations on the power handling ability of a transistor: average junction temperature and second breakdown. Safe operating area curves indicate  $I_C - V_{CE}$  limits of the transistor that must be observed for reliable operation: i.e., the transistor must not be subjected to greater dissipation than the curves indicate.

The data of Figure 7 is based on  $T_{J(pk)} = 200^\circ\text{C}$ ;  $T_C$  is variable depending on conditions. Second breakdown pulse

limits are valid for duty cycles to 10% provided  $T_{J(pk)} < 200^\circ\text{C}$ . At high case temperatures, thermal limitations will reduce the power that can be handled to values less than the limitations imposed by second breakdown.

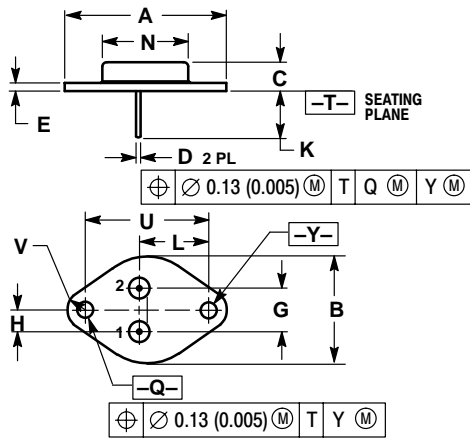

**Figure 13. Power Derating**

# 2N3773 2N6609

## PACKAGE DIMENSIONS

### CASE 1-07 TO-204AA (TO-3) ISSUE Z



- NOTES:
1. DIMENSIONING AND TOLERANCING PER ANSI Y14.5M, 1982.
  2. CONTROLLING DIMENSION: INCH.
  3. ALL RULES AND NOTES ASSOCIATED WITH REFERENCED TO-204AA OUTLINE SHALL APPLY.

DIM	INCHES		MILLIMETERS	
	MIN	MAX	MIN	MAX
A	---	1.550 REF	---	39.37 REF
B	---	1.050	---	26.67
C	0.250	0.335	6.35	8.51
D	0.038	0.043	0.97	1.09
E	0.055	0.070	1.40	1.77
G	0.430 BSC		10.92 BSC	
H	0.215 BSC		5.46 BSC	
K	0.440	0.480	11.18	12.19
L	0.665 BSC		16.89 BSC	
N	---	0.830	---	21.08
Q	0.151	0.165	3.84	4.19
U	1.187 BSC		30.15 BSC	
V	0.131	0.188	3.33	4.77

STYLE 1:  
PIN 1: BASE  
2: EMITTER  
CASE: COLLECTOR

## Notes

## Notes

PowerBase is a trademark of Semiconductor Components Industries, LLC.

**ON Semiconductor** and  are trademarks of Semiconductor Components Industries, LLC (SCILLC). SCILLC reserves the right to make changes without further notice to any products herein. SCILLC makes no warranty, representation or guarantee regarding the suitability of its products for any particular purpose, nor does SCILLC assume any liability arising out of the application or use of any product or circuit, and specifically disclaims any and all liability, including without limitation special, consequential or incidental damages. "Typical" parameters which may be provided in SCILLC data sheets and/or specifications can and do vary in different applications and actual performance may vary over time. All operating parameters, including "Typicals" must be validated for each customer application by customer's technical experts. SCILLC does not convey any license under its patent rights nor the rights of others. SCILLC products are not designed, intended, or authorized for use as components in systems intended for surgical implant into the body, or other applications intended to support or sustain life, or for any other application in which the failure of the SCILLC product could create a situation where personal injury or death may occur. Should Buyer purchase or use SCILLC products for any such unintended or unauthorized application, Buyer shall indemnify and hold SCILLC and its officers, employees, subsidiaries, affiliates, and distributors harmless against all claims, costs, damages, and expenses, and reasonable attorney fees arising out of, directly or indirectly, any claim of personal injury or death associated with such unintended or unauthorized use, even if such claim alleges that SCILLC was negligent regarding the design or manufacture of the part. SCILLC is an Equal Opportunity/Affirmative Action Employer.

## PUBLICATION ORDERING INFORMATION

### **NORTH AMERICA Literature Fulfillment:**

Literature Distribution Center for ON Semiconductor  
P.O. Box 5163, Denver, Colorado 80217 USA  
**Phone:** 303-675-2175 or 800-344-3860 Toll Free USA/Canada  
**Fax:** 303-675-2176 or 800-344-3867 Toll Free USA/Canada  
**Email:** ONlit@hibbertco.com  
Fax Response Line: 303-675-2167 or 800-344-3810 Toll Free USA/Canada

**N. American Technical Support:** 800-282-9855 Toll Free USA/Canada

**EUROPE:** LDC for ON Semiconductor – European Support

**German Phone:** (+1) 303-308-7140 (Mon-Fri 2:30pm to 7:00pm CET)  
**Email:** ONlit-german@hibbertco.com  
**French Phone:** (+1) 303-308-7141 (Mon-Fri 2:00pm to 7:00pm CET)  
**Email:** ONlit-french@hibbertco.com  
**English Phone:** (+1) 303-308-7142 (Mon-Fri 12:00pm to 5:00pm GMT)  
**Email:** ONlit@hibbertco.com

**EUROPEAN TOLL-FREE ACCESS\*: 00-800-4422-3781**

\*Available from Germany, France, Italy, UK, Ireland

### **CENTRAL/SOUTH AMERICA:**

**Spanish Phone:** 303-308-7143 (Mon-Fri 8:00am to 5:00pm MST)  
**Email:** ONlit-spanish@hibbertco.com  
**Toll-Free from Mexico:** Dial 01-800-288-2872 for Access –  
then Dial 866-297-9322

**ASIA/PACIFIC:** LDC for ON Semiconductor – Asia Support

**Phone:** 1-303-675-2121 (Tue-Fri 9:00am to 1:00pm, Hong Kong Time)  
**Toll Free from Hong Kong & Singapore:**  
**001-800-4422-3781**  
**Email:** ONlit-asia@hibbertco.com

**JAPAN:** ON Semiconductor, Japan Customer Focus Center

4-32-1 Nishi-Gotanda, Shinagawa-ku, Tokyo, Japan 141-0031  
**Phone:** 81-3-5740-2700  
**Email:** r14525@onsemi.com

**ON Semiconductor Website:** <http://onsemi.com>

For additional information, please contact your local Sales Representative.