

Chip Varistors

Countermeasure for surge voltage and static electricity

AVR series

Type: **AVR-M**
 AVRL

Issue date: September 2011

Datasheet.Live

- All specifications are subject to change without notice.
 - Conformity to RoHS Directive: This means that, in conformity with EU Directive 2002/95/EC, lead, cadmium, mercury, hexavalent chromium, and specific bromine-based flame retardants, PBB and PBDE, have not been used, except for exempted applications.
-

Varistors(SMD)

Countermeasure for Surge Voltage and Static Electricity

AVR Series AVR-M, AVRL Types

Varistors are voltage dependent nonlinear resistive elements with a resistance that decreases rapidly when the voltage is over the constant value.

Varistor is equivalent with Zener diode of two series connection. Therefore, do not have polarity.

CURRENT vs. VOLTAGE CHARACTERISTICS

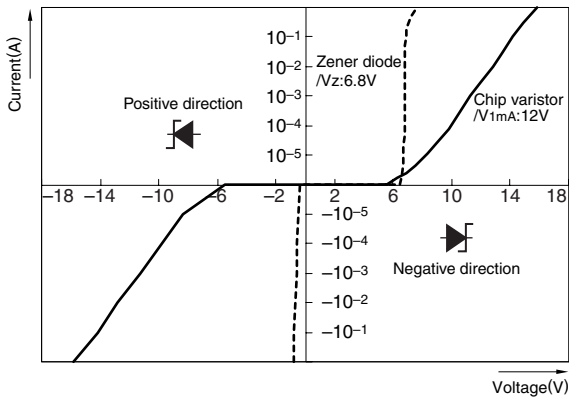

EQUIVALENT CIRCUIT

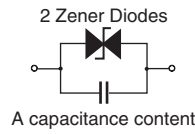

THE EFFECT OF THE VARISTOR WITHOUT VARISTOR

A malfunction and failure of electronic equipment

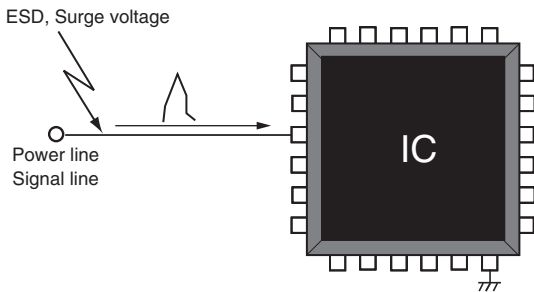

WITH VARISTOR

Suppress abnormal voltage by inserting varistor in a circuit

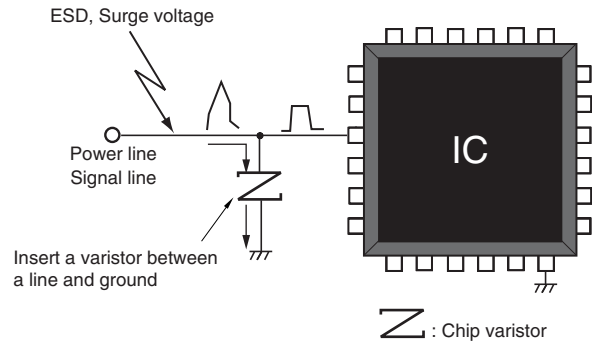

FEATURES

- No polarity, due to symmetrical current-voltage characteristics. Equivalent to anode common type Zener diode.
- Excellent electrostatic absorption capability. Response is as good or better than Zener diode. Keeps symmetrical current-voltage characteristics even after electrostatic absorption.
- Adopted the inner electrodes lamination structure. Wide range of varistor voltages are available in series (6.8 to 39V). Low capacitance items are available in series (1.1pF to). World's smallest 0603-, 1005-, 1608-, 2012-chip types and 1410-array type are available in series.
- Excellent mount reliability. Good for Pb-free soldering. Adopted (Ni/Sn) electroplating. Achieved good solderability and solder heat resistance.
- Can replace a Zener diode + capacitor combination. Reduced footprint and total mounting cost.

APPLICATIONS

- Electrostatic absorption
- Pulse noise absorption

TEMPERATURE RANGES

Type	AVR-M1005/1608/2012	AVR-M14A2/0603/AVRL
Operating	-40 to +125°C	-40 to +85°C
Storage	-40 to +125°C	-40 to +85°C

APPLICATION EXAMPLES

Consumer product	Application
Mobile phone	Data terminal
Digital video camera	LCD panel
Digital camera	Touch panel
PDA	Button and switch unit
Note PC	Battery terminal
DVD-ROM, CD-ROM	Audio-Video input-output terminal
CD/MD/MP3 player	Microphone/receiver unit
Game machine	Controller unit
	CAN-BUS
	ECU
In-car equipment	Connector
	Air conditioner panel
	Car audio
	Car navigation

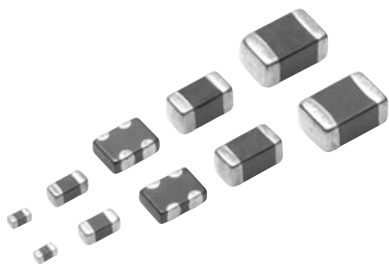

INTERNAL STRUCTURE

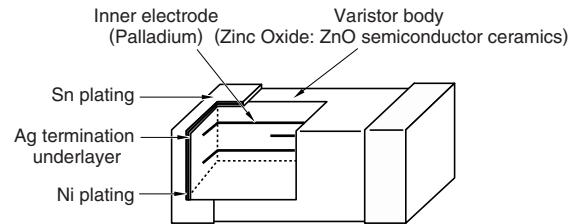

CIRCUITS

SINGLE TYPE



ARRAY TYPE

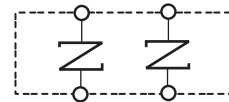

OPERATIONAL VOLTAGE RANGES

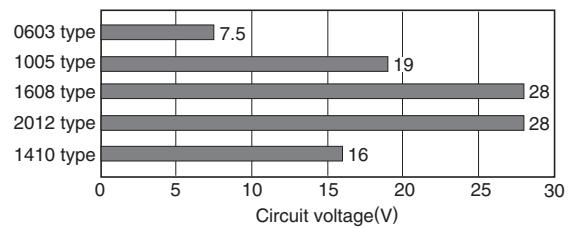

RECOMMENDED REFLOW SOLDERING CONDITIONS

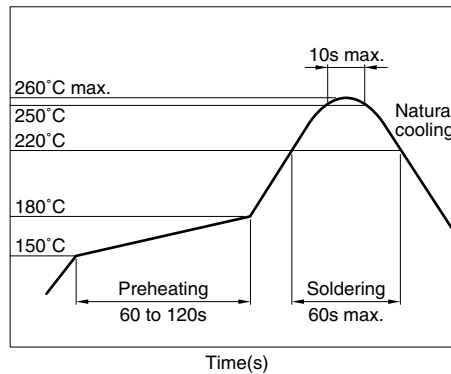

AVR-M TYPE

PRODUCT IDENTIFICATION

AVR-M	1005	C	270	M	T	AAB
(1)	(2)	(3)	(4)	(5)	(6)	(7)

(1) Series name

(2) Dimensions L×W

0603	0.6×0.3mm
1005	1.0×0.5mm
1608	1.6×0.8mm
2012	2.0×1.2mm
14A2	1.4×1.0mm (2-element)

(3) Structure code

(4) Varistor voltage

270	27×10 ⁰ V
-----	----------------------

(5) Varistor voltage tolerance

K	±10%
M	±20%

(6) Packaging style

T	Taping
B	Bulk

(7) Capacitance and TDK internal code

SHAPES AND DIMENSIONS/RECOMMENDED PC BOARD PATTERN

0603/1005/1608/2012 TYPES

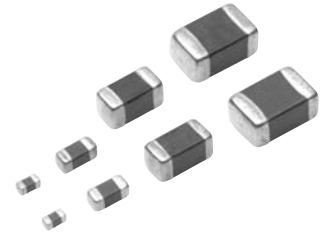
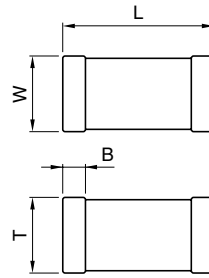

Dimensions in mm

Type	L	W	T	B min.	Weight (mg)typ.
0603	0.6±0.03	0.3±0.03	0.3±0.03	0.1	0.2
1005	1.0±0.05	0.5±0.05	0.5±0.05	0.1	1.2
1608	1.6±0.1	0.8±0.1	0.8±0.1	0.2	5
2012	2.0±0.2	1.25±0.2	1.0±0.2	0.2	15

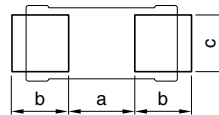

Dimensions in mm

Type	a	b	c
0603	0.25 to 0.35	0.2 to 0.3	0.25 to 0.35
1005	0.3 to 0.5	0.35 to 0.45	0.4 to 0.6
1608	0.6 to 0.8	0.6 to 0.8	0.6 to 0.8
2012	0.9 to 1.2	0.7 to 0.9	0.9 to 1.2

1410 TYPE

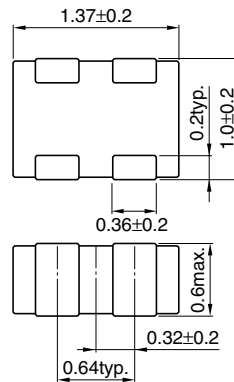

Weight: 4mg typ.

Dimensions in mm

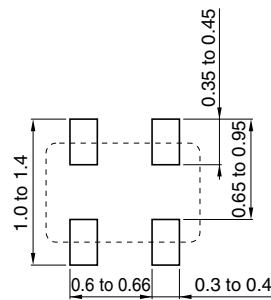

Dimensions in mm

ELECTRICAL CHARACTERISTICS

Part No.	Varistor voltage (Breakdown voltage) $V_{1mA}(V)[DC1mA]$		Maximum continuous voltage (Rated voltage) $V_{dc}(V)$	Clamping voltage $V_{cl}(V)$ [8/20 μ s]	Maximum energy $E(\text{Joule})$ [10/1000 μ s]	Maximum peak current $I_p(A)$ [8/20 μ s]	Capacitance $C(\text{pF})$ [1kHz, 1Vrms]	Packaging quantities (Taping) (pieces/reel)	
0603 type									
AVRM0603C6R8N □*101N	6.8	(4.76 to 8.84)	3.5 max.	14[1A]	0.01 max.	10 max.	100 typ.	15,000	
AVRM0603C080M □101N	8	(6.4 to 9.6)	5.5 max.	17[1A]	0.01 max.	4 max.	100 typ.		
AVRM0603C120M □101N	12.8	(10 to 15.6)	5.5 max.	20[1A]	0.01 max.	5 max.	100 typ.		
AVR-M0603C120M □AAB	12	(9.6 to 14.4)	7.5 max.	23[1A]	0.01 max.	1 max.	33 typ.		
1005 type									
AVRM1005C6R8N □101N	6.8	(4.76 to 8.84)	3.5 max.	14[1A]	0.02 max.	10 max.	100 typ.	10,000	
AVR-M1005C080M □AAB	8	(6.4 to 9.6)	5.5 max.	14[1A]	0.04 max.	25 max.	650 typ.		
AVR-M1005C080M □ADB	8	(6.4 to 9.6)	5.5 max.	14[1A]	0.04 max.	25 max.	480 typ.		
AVR-M1005C080M □ABB	8	(6.4 to 9.6)	5.5 max.	15[1A]	0.02 max.	3 max.	100 typ.		
AVR-M1005C080M □ACB	8	(6.4 to 9.6)	5.5 max.	19[1A]	0.01 max.	1 max.	33 typ.		
AVR-M1005C120M □AAB	12	(9.6 to 14.4)	7.5 max.	20[1A]	0.05 max.	10 max.	130 typ.		
AVRM1005C270K □101N	27	(24 to 30)	19 max.	55[1A]	0.06 max.	4 max.	100 typ.		
AVR-M1005C270M □AAB	27	(21.6 to 32.4)	15 max.	50[1A]	0.06 max.	4 max.	40 typ.		
AVR-M1005C270M □ABB	27	(21.6 to 32.4)	15 max.	50[1A]	0.05 max.	1 max.	15 typ.		
1608 type									
AVR-M1608C080M □AAB	8	(6.4 to 9.6)	5.5 max.	15[2A]	0.09 max.	30 max.	650 typ.	4,000	
AVR-M1608C120M □6AB	12	(9.6 to 14.4)	7.5 max.	20[2A]	0.09 max.	50 max.	1050 typ.		
AVR-M1608C120M □2AB	12	(9.6 to 14.4)	7.5 max.	20[2A]	0.06 max.	15 max.	400 typ.		
AVR-M1608C180M □6AB	18	(14.4 to 21.6)	11 max.	30[2A]	0.1 max.	30 max.	600 typ.		
AVR-M1608C220K □6AB	22	(19.8 to 24.2)	16 max.	34[2A]	0.1 max.	30 max.	560 typ.		
AVR-M1608C220K □2AB	22	(19.8 to 24.2)	16 max.	37[2A]	0.03 max.	10 max.	210 typ.		
AVR-M1608C270K □6AB	27	(24 to 30)	19 max.	42[2A]	0.1 max.	48 max.	430 typ.		
AVR-M1608C270K □2AB	27	(24 to 30)	19 max.	42[2A]	0.1 max.	20 max.	160 typ.		
AVR-M1608C270K □ACB	27	(24 to 30)	19 max.	54[2A]	0.05 max.	10 max.	60 typ.		
AVR-M1608C270M □AAB	27	(21.6 to 32.4)	17 max.	52[2A]	0.05 max.	2 max.	30 typ.		
AVR-M1608C270M □ABB	27	(21.6 to 32.4)	17 max.	52[2A]	0.05 max.	2 max.	15 typ.		
AVRM1608C390K □271N	39	(35 to 43)	28 max.	69[2A]	0.1 max.	78 max.	270 typ.		
2012 type									
AVR-M2012C120M □6AB	12	(9.6 to 14.4)	7.5 max.	20[5A]	0.2 max.	60 max.	1000 typ.		2,000
AVR-M2012C220K □6AB	22	(19.8 to 24.2)	16 max.	38[5A]	0.3 max.	100 max.	800 typ.		
AVR-M2012C390K □6AB	39	(35 to 43)	28 max.	62[5A]	0.3 max.	100 max.	430 typ.		
1410 type									
AVR-M14A2C240M □600N	24	(20 to 27)	16 max.	50[1A]	0.01 max.	5 max.	60 typ.[1MHz]	4,000	
AVR-M14A2C270M □470N	27	(21.6 to 32.4)	15 max.	54[1A]	0.007 max.	5 max.	47 typ.[1MHz]		
AVRM14A2C270M □150N	27	(21.6 to 32.4)	15 max.	55[1A]	0.02 max.	3 max.	15 typ.[1MHz]		
AVRM14A2C270M □3R3F	27	(21.6 to 32.4)	10 max.	45[0.2A]	0.002 max.	0.2 max.	3.3 typ.[1MHz]		

* □ : Packaging style(T: Taping/B: Bulk)

TERMINOLOGY

Item	Unit	Terminology
Varistor voltage (Breakdown voltage)	V_{1mA} (V)	Voltage measured across the varistor when DC1mA is applied.
Maximum continuous voltage (Rated voltage)	V_{dc} (V)	Maximum DC voltage that can be applied continuously. Varistor leakage current: 50 μ A max. (Within the range of maximum allowable circuit voltage)
Clamping voltage	V_{cl} (V)	Voltage appearing across the varistor when a pulse current (8/20 μ s ^{*1}) of specified peak value is applied.
Maximum energy	E (Joule)	Maximum energy that can be absorbed without deteriorating varistor characteristics when an impulse (10/1000 μ s ^{*2}) is applied once.
Maximum peak current	I_p (A)	Maximum current that can be withstood without deteriorating varistor characteristics when an impulse current (8/20 μ s ^{*1}) is applied once.
Capacitance	C (pF)	Capacitance measured at 1kHz (or 1MHz) of oscillator frequency and 1Vrms of oscillator voltage.

*1 8/20 μ s test waveform

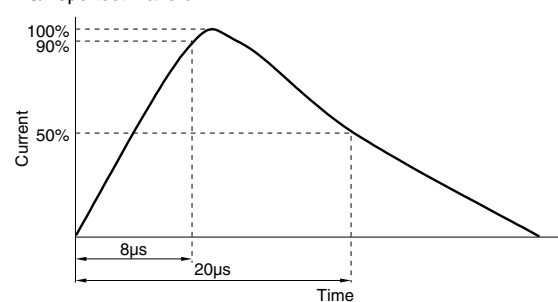

*2 10/1000 μ s test waveform

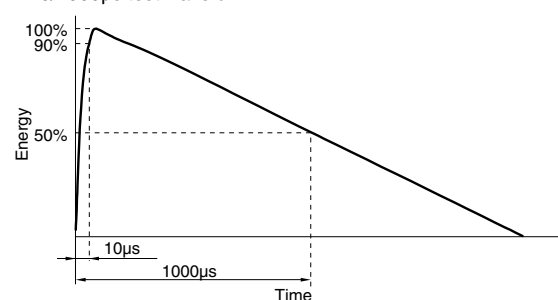

• All specifications are subject to change without notice.

AVRL TYPE

PRODUCT IDENTIFICATION

AVRL	10	1A	3R3	F	T	A
(1)	(2)	(3)	(4)	(5)	(6)	(7)

(1) Series name

(2) Dimensions L×W

10	1.0×0.5mm
16	1.6×0.8mm

(3) Maximum continuous voltage

1A	10Vdc
----	-------

(4) Capacitance

1R1	1.1pF
3R3	3.3pF
6R8	6.8pF

(5) Capacitance tolerance

N	±0.3pF
F	±1pF
G	±2pF

(6) Packaging style

T	Taping
B	Bulk

(7) Varistor voltage and TDK internal code

SHAPES AND DIMENSIONS/RECOMMENDED PC BOARD PATTERN

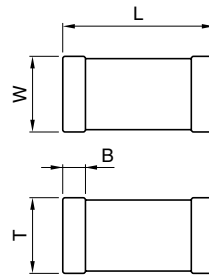

Dimensions in mm

Type	L	W	T	B min.	Weight (mg)typ.
1005	1.0±0.05	0.5±0.05	0.5±0.05	0.1	1.2
1608	1.6±0.1	0.8±0.1	0.8±0.1	0.2	5

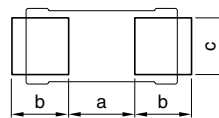

Dimensions in mm

Type	a	b	c
1005	0.3 to 0.5	0.35 to 0.45	0.4 to 0.6
1608	0.6 to 0.8	0.6 to 0.8	0.6 to 0.8

ELECTRICAL CHARACTERISTICS

Part No.	Capacitance C(pF) [1MHz, 1Vrms]	Maximum continuous voltage (Rated voltage) Vdc(V)	Insulation resistance Rdc(MΩ) [3Vrms]	Varistor voltage V _{1mA} (V)[DC1mA]	Packaging quantities (Taping) (pieces/reel)
1005 type					
AVRL101A1R1N□*A	1.1[0.8 to 1.4]	10 max.	10 min.	90 typ.	10,000
AVRL101A1R1N□B	1.1[0.8 to 1.4]	10 max.	10 min.	39 typ.	
AVRL101C2R2D□A	2.2[1.7 to 2.7]	16 max.	10 min.	90 typ.	
AVRL101A3R3F□A	3.3[2.3 to 4.3]	10 max.	10 min.	27 typ.	
AVRL101A6R8G□A	6.8[4.8 to 8.8]	10 max.	10 min.	27 typ.	
1608 type					
AVRL161A1R1N□A	1.1[0.8 to 1.4]	10 max.	10 min.	90 typ.	4,000
AVRL161A1R1N□B	1.1[0.8 to 1.4]	10 max.	10 min.	39 typ.	
AVRL161A3R3F□A	3.3[2.3 to 4.3]	10 max.	10 min.	27 typ.	
AVRL161A6R8G□A	6.8[4.8 to 8.8]	10 max.	10 min.	27 typ.	

* □ : Packaging style(T: Taping/B: Bulk)

TERMINOLOGY

Item	Unit	Terminology
Capacitance	C (pF)	Capacitance measured at 1MHz of oscillator frequency and 1Vrms of oscillator voltage.
Maximum continuous voltage (Rated voltage)	Vdc (V)	Maximum DC voltage that can be applied continuously. Varistor leakage current: 50μA max. (Within the range of maximum allowable circuit voltage)
Insulation resistance	Rdc (MΩ)	Insulation resistance appearing across the varistor when specified voltage is applied.
Varistor voltage (Breakdown voltage)	V _{1mA} (V)	Voltage measured across the varistor when DC1mA is applied.

TYPICAL ELECTRICAL CHARACTERISTICS CURRENT vs. VOLTAGE CHARACTERISTICS

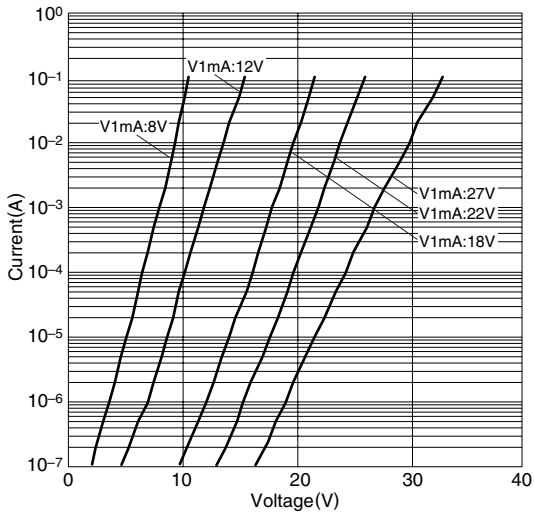

IMPEDANCE vs. FREQUENCY CHARACTERISTICS

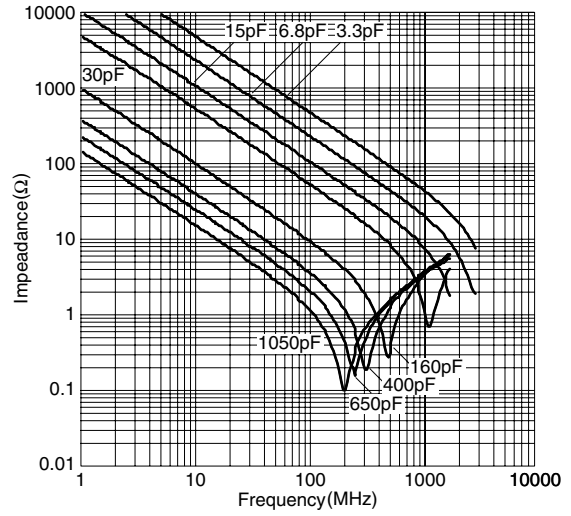

TRANSMISSION CHARACTERISTICS

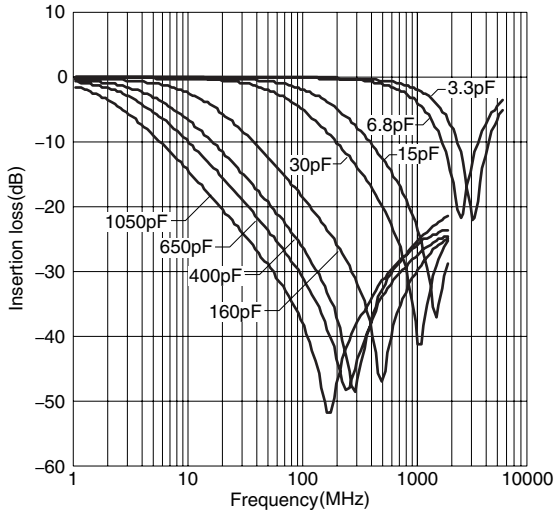

CAPACITANCE vs. FREQUENCY CHARACTERISTICS

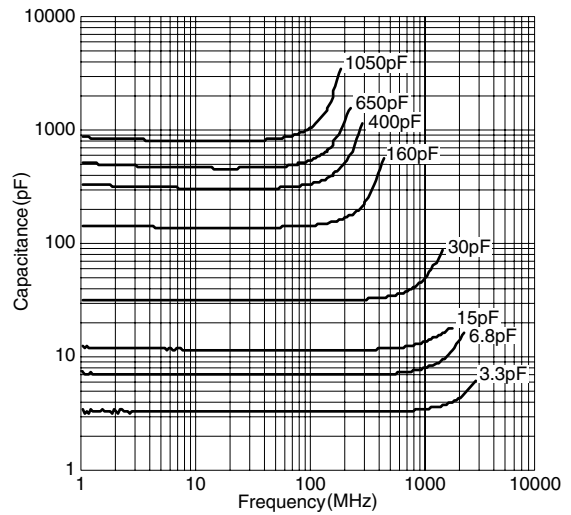

• All specifications are subject to change without notice.

ELECTROSTATIC DISCHARGE TESTS

TEST CONDITIONS

150pF, 330Ω contact discharge
Charged voltage /8kV, 0.1s interval

MEASURING CIRCUIT

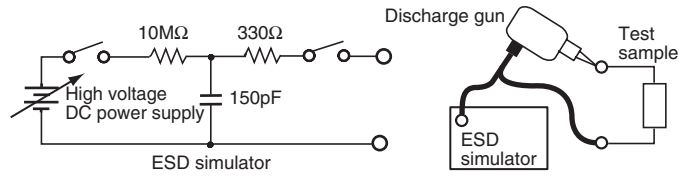

AVR-M0603 TYPE

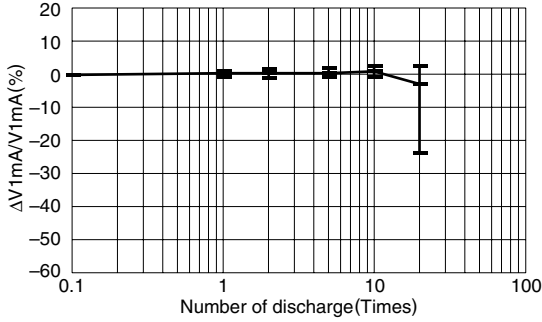

AVR-M1005 TYPE

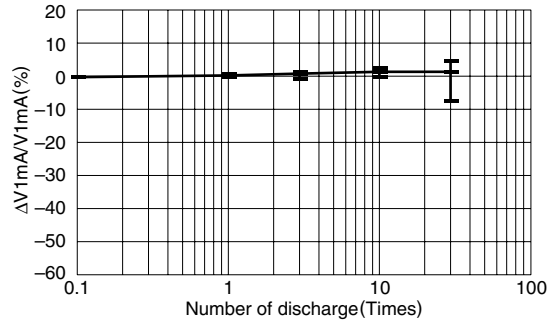

AVR-M1608 TYPE

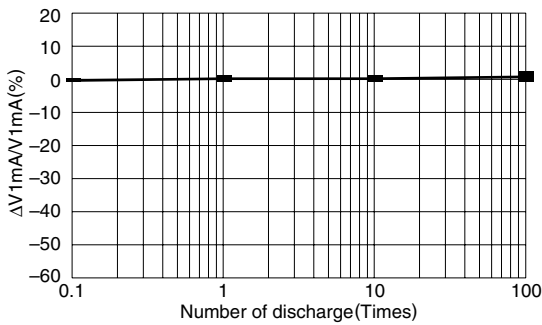

AVRL101A3R3F

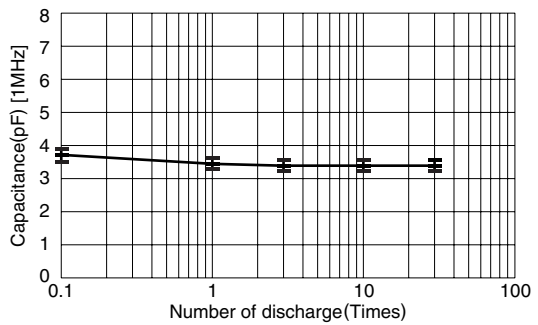

• All specifications are subject to change without notice.

ELECTROSTATIC ABSORPTION CHARACTERISTICS

DISCHARGE CURRENT WAVEFORM

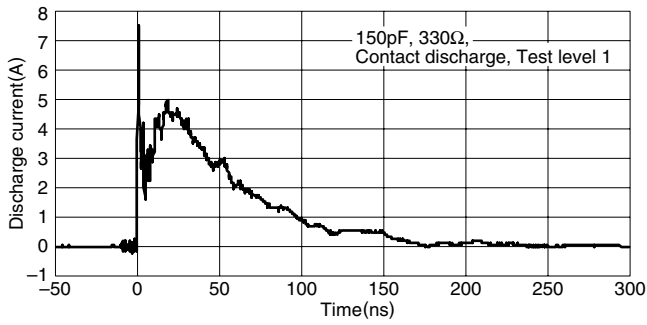

WAVEFORM PARAMETERS [IEC61000-4-2]

Test level	ESD Charge voltage (kV)	First peak current of discharge (A)	Rise time (ns)
1	2	7.5	0.7 to 1.0
2	4	15	0.7 to 1.0
3	6	22.5	0.7 to 1.0
4	8	30	0.7 to 1.0

DISCHARGE VOLTAGE WAVEFORM

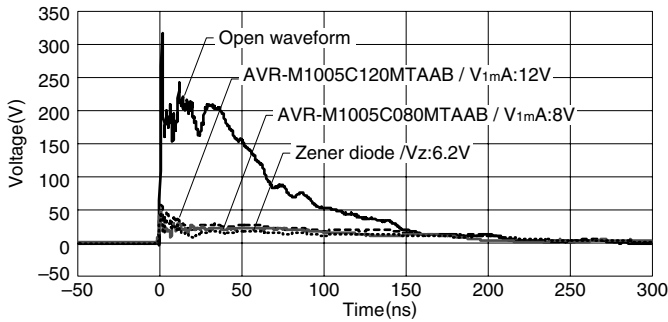

MEASURING CIRCUIT

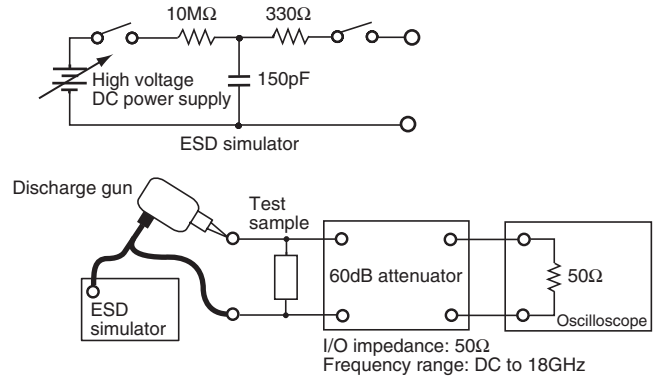

ESD ABSORPTION CHARACTERISTICS COMPARISON OF VARIOUS ELEMENTS

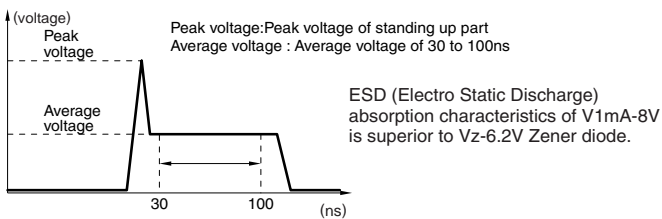
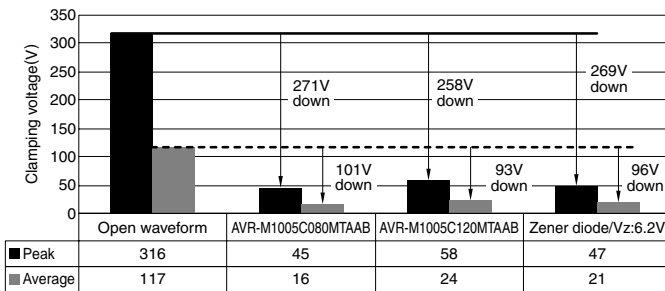

MERITS OF REPLACEMENT FROM ZENER DIODE

(1) Reduction in the number of parts

(2) Reduction in mounting cost

COMPARISON OF FOOTPRINT

Zener diode

Chip varistor

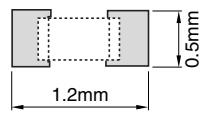
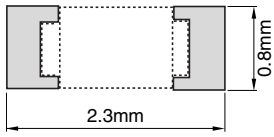

Save a mount area 65% down

EXAMPLE OF REPLACEMENT AT AUDIO TERMINAL

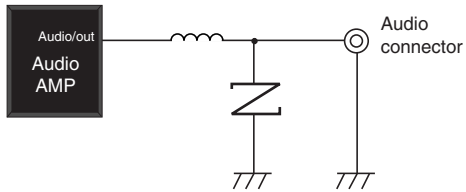
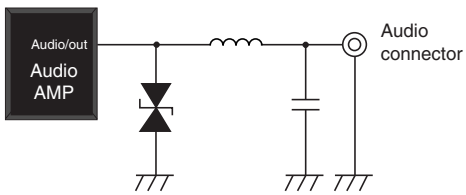

: Chip varistor

(3) Improved electrostatic absorption capability

COMPARE DATA OF CHIP VARISTOR AND ZENER DIODE ABOUT IC PROTECTION

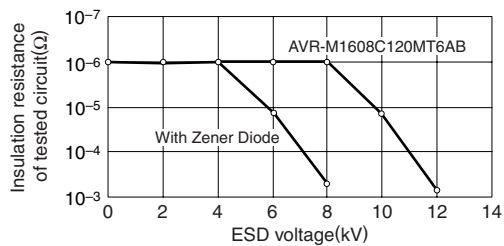

CMOS: D74HC04C
 ESD generator : Noise Laboratory Co.,Ltd., ESS -630A
 200pF-0Ω method model equipment
 Contact type discharge
 ESD applied point: Vcc-ground

APPLICATION EXAMPLES

CELLULAR PHONE

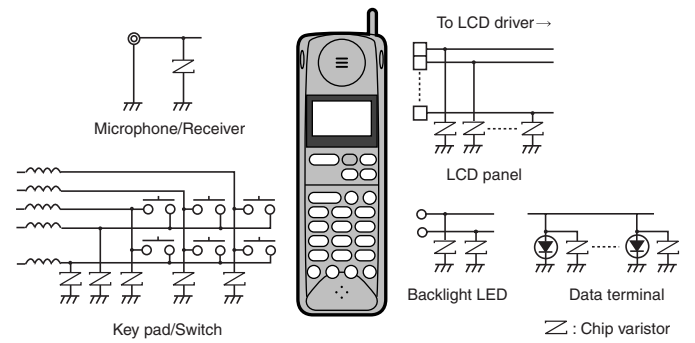

AUDIO/VIDEO

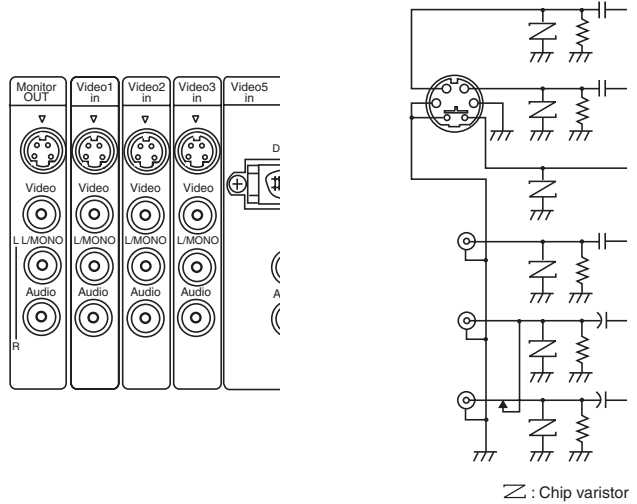

APPLICATION EXAMPLES

USB 2.0

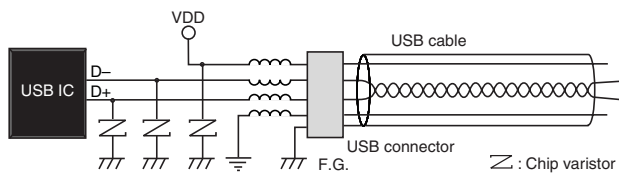

MEASURING CIRCUIT

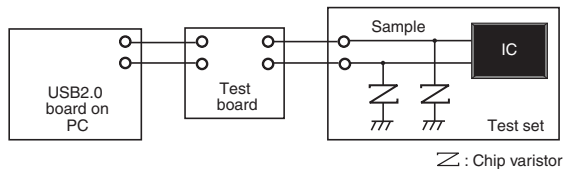

WITHOUT VARISTOR

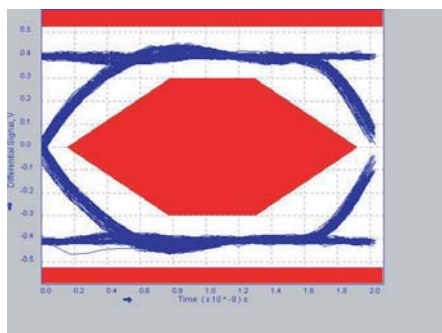

WITH VARISTOR

AVRL101A3R3FT(3.3pF)

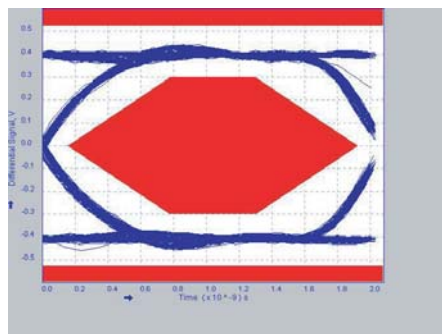

AVRL101A6R8GT(6.8pF)

